



## Welcome to **Metropolitan Pipe & Supply**

Since our inception over seven decades ago, **Metropolitan Pipe & Supply** has taken pride in delivering the highest quality and best value to our customers. This philosophy has helped us grow into an industry leader, distributing a wide range of plumbing, heating, valves, and industrial supplies throughout New England and beyond.

As our many satisfied customers have come to know, **Metropolitan Pipe & Supply** offers not only products and services on which you can depend, but also a convenient, cost-effective partnership that will help your business succeed.

We hope that you find the products you require contained in the following pages. We can special order any product you don't see - on time and at the right price. Our employees have over a century of combined experience - rest assured that together, we can solve your problems.

If you have any questions or would like to learn more about what **Metropolitan Pipe & Supply** has to offer, please feel free to call us at **1-800-METPIPE** (638-7473), or visit our website at [www.metpipe.com](http://www.metpipe.com).

Sincerely,

**Kevin A. Brown**  
President

## Minutes from Downtown Boston

Our unique location puts us close to all the action.

303 Binney Street  
Cambridge, MA 02142

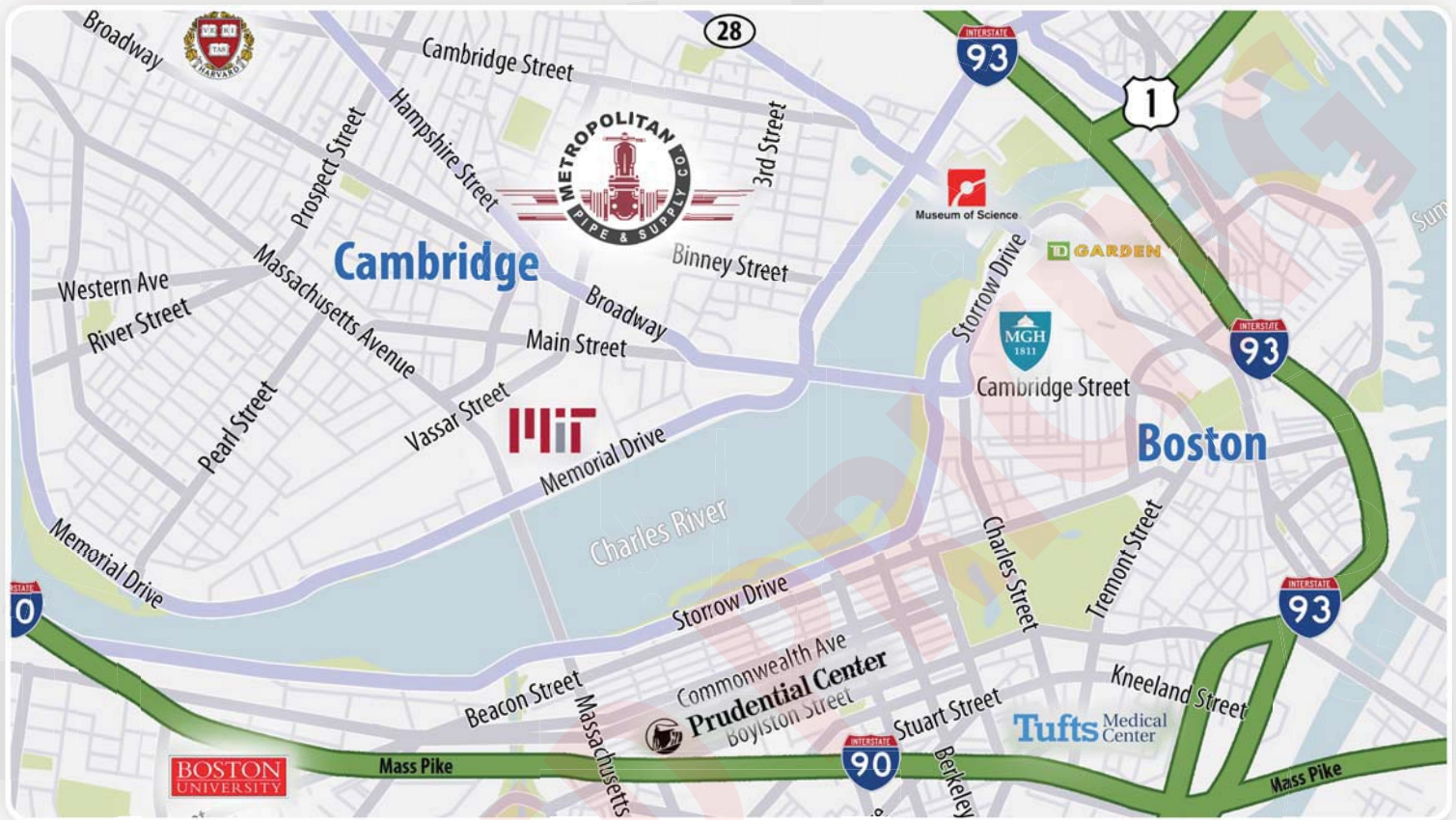

## General Directions

### From The South

- Take Interstate 95 North to Interstate 93 North following signs to Boston
- In Boston, go through the tunnel then take Exit 26 (Cambridge-Somerville).
- Slow at the bottom of the ramp, keep right.
- At the set of lights, Turn left.
- Go under Train Bridge, then turn right on to Route 28 (O'Brien Hwy).
- At the first set of lights turn left on to Land Blvd.
- At the second lights turn right on to Binney St.
- Go through two sets of lights on Binney St. Metropolitan Pipe is 1/8 mile, on the right.

### From The North

- Take 93 South to Exit 30 (Mystic Ave/Somerville).
- Take a Left at the end of the ramp on to Route 38 (Mystic Avenue).
- At the 4th set of lights, turn right on to Route 28 (McGrath Hwy).
- At the 8th set of lights, turn right on to Land Blvd. (not quite 1/2 mile after McDonalds).
- At the 2nd set of lights, turn right on to Binney Street
- Go through two sets of lights on Binney St. Metropolitan Pipe is 1/8 mile on the right.

### From The West

- Take Rt. 90 East (Mass Pike) to Exit 18 (Cambridge-Allston). Bear right on ramp for Cambridge.
- At bottom of Exit ramp, go straight across bridge on to River St. (Cambridge)
- At the 5th set of lights, turn right - Mass Ave.
- At the 5th set of lights, turn left - Vassar St.
- At the 2nd set of lights, turn right - Broadway.
- At the 2nd set of lights, turn left - Third St.
- At the 1st set of lights, turn left - Binney St. Metropolitan Pipe is 1/8 mile on the right.

**1-800-MetPipe**  
[www.MetPipe.com](http://www.MetPipe.com)

On the cutting edge...

METROPOLITAN PIPE  
PRODUCT CATALOG

## MetPipe.com Web Order Entry

Place orders, check inventory, view your order history, and print invoices - **anytime, anywhere.**

1-800-MetPipe  
www.MetPipe.com

Product Search [ ] Search

Reorder Pad (View your previously ordered items)  
Quickpad (Add products from our catalog)

MAIN MY ACCOUNT MY PRODUCT GROUPS MY CARTS CHECKOUT LOGOFF

Shipping Address 96 FULKERSON STREET CAMBRIDGE, MA 02142  
Shipping Info Ship Via: OT OUR TRUCK Date: 02/26/2011 Ship Date: 02/25/2011 Info: None  
Required 2 Your Account Team Outside: Outside Sales Team - 617-492-6400 Inside: Inside Sales Team - 617-492-6400  
Shopping Cart 2 Items in Cart: 0 Subtotal: \$ 0.00

Browse By Manufacturer  
Pipe  
Valves  
Fittings  
Plumbing  
Heating  
Tools  
Chemicals  
Miscellaneous  
Parts

My Account > Open Orders/Bids > Order Number: S2611370.1

S2611370.1

Shipping Address: METROPOLITAN STOCKROOM (TEST) 96 FULKERSON STREET CAMBRIDGE MA 02142  
Billing Address: METROPOLITAN STOCKROOM (TE 96 FULKERSON STREET CAMBRIDGE, MA 02142

Order Details  
Order Dates: 02/02/2011  
Required Date: 02/02/2011  
Ship Date: 02/02/2011  
Ship Via: OT OUR TRUCK  
Branch: 02  
Ordered By: 617-2  
PD #: 02  
Release #: 02  
Status: 02

Qty	Item Description	Unit	Price
1000ea	71-ARS-64 1in APOLLO BRONZE PS S/S B&S 600WOG		49.648
10ea	1-1/4 #5 NU-RAL TEE #5-7 07040		12.900
10ea	1-1/4 #3 NU-RAL 90-ELL #3-7 07020		11.030
10ea	1-1/4 #45 NU-RAL SQ FLOOR FLANGE 27130		11.220
1000ea	1-1/4 CXC 90-ELL		9.921
10ea	1-1/4 IS CP TEE		181.143
1ea	DURACELL D ALKALINE BATTERY BULK SINGLE MN1300		2.400
1ea	DURACELL AAA ALKALINE BATTERY BULK SINGLE MN2400		1.500
1ea	DOUBLE-A BATTERY ALKALINE HEAVY DUTY		1.600
Subtotal			58798
Tax			3674
Freight			0
Handling			0
Discount			0
Order Total			62473

Signed by: John W. Doe 03/16/2011 12:21PM EST

Click here for a printer friendly version of this page

Copy Items to Product Group Copy Items to Current Order

Modify Bid Cancel Bid

View our privacy statement Contact the Webmaster with questions about this site. © 2011 Metropolitan Pipe & Supply

Visit our website today to sign up:  
<http://woe.metpipe.com>

1-800-MetPipe  
www.MetPipe.com

Product Search [ ] Search

Reorder Pad (View your previously ordered items)  
Quickpad (Add products from our catalog)

MAIN MY ACCOUNT MY PRODUCT GROUPS MY CARTS CHECKOUT LOGOFF

Shipping Address 96 FULKERSON STREET CAMBRIDGE, MA 02142  
Shipping Info Ship Via: OT OUR TRUCK Date: 02/26/2011 Ship Date: 02/25/2011 Info: None  
Required 2 Your Account Team Outside: Outside Sales Team - 617-492-6400 Inside: Inside Sales Team - 617-492-6400  
Shopping Cart 2 Items in Cart: 0 Subtotal: \$ 0.00

Browse By Manufacturer  
Pipe  
Valves  
Fittings  
Plumbing  
Heating  
Tools  
Chemicals  
Miscellaneous  
Parts

Search Results for 7010401 > Part #1313

Product Description  
70-104-01 3/4in APOLLO BRONZE PS 600WOG BALL VALVE  
Your Price: \$ 18.228 ea  
Total Availability: 311 ea

Quantity 1 ea

ADD ITEM TO CART

ADD ITEM TO MY PRODUCT GROUPS

Hide Custom Part Numbers and Availability

Custom Part Numbers	Availability by Branch
None Assigned Enter a New Custom Part Number	Branch 1 METPIPE Total Availability:
ADD	Availability 311 ea 311 ea

Other Items You May Like ... (more)

3/4XCL STD BRASS HIPPLE \$2.77	1/4XCL STD BRASS HIPPLE \$1.39	3/4 BRASS 90-ELL \$8.86
--------------------------------	--------------------------------	-------------------------

Image pictured may differ from actual product appearance, especially color.

View our privacy statement Contact the Webmaster with questions about this site. © 2011 Metropolitan Pipe & Supply. All Rights Reserved.



## Electronic Billing

Save paper and get your invoices online! Available on Web Order Entry, E-mail, Fax, or Postal - we do it all!  
Visit <http://ebilling.metpipe.com> to sign up!

## Vendor Managed Inventory & Stockroom Program

Never run out of the parts you need. From crucial part replenishment to full blown inventory management systems, Metropolitan Pipe has the experience and the technology to handle your stockroom needs.

Contact your account manager today to learn more!

Product ID: 454645  
Kohler 4330-0 Kingston elongated wall-hung bowl with top spud  
Aisle 7 - Shelf B



1-800-MetPipe  
[www.MetPipe.com](http://www.MetPipe.com)

## Pipe Fabrication Shop

Not only do we have **over 60 miles of pipe in stock** - we can cut, thread, groove, make-on, and weld it, too! Our state of the art pipe fabrication shop is at your disposal - and no job is too big or too small.

› Cut to length › Thread › Groove › Make-on › Welding

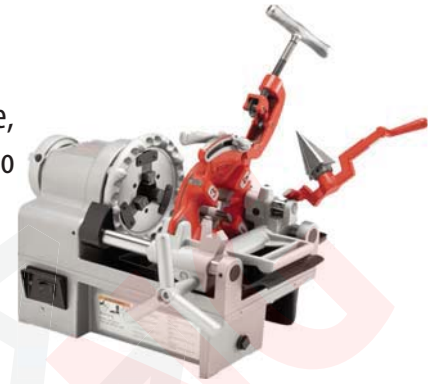

## Valve Actuation

Our in-house valve actuation shop is equipped to add actuators (both pneumatic and electric) to many different sizes and types of valves. Contact a salesperson today for more information!

## Product Training

We are proud to offer group or one-on-one training on all of the products we carry. Get the knowledge you need from our expert sales team! With over a century of combined experience, Metropolitan Pipe has the know-how to help you with your next job.



## FREE Local Delivery

Our professional delivery team and fleet of specialized trucks ensure the product you need is at the job site - on time. Forklift equipped trucks are available for tough jobs, and in special occasions, we can deliver any time during the day or night.

Ground Service: Time In Transit

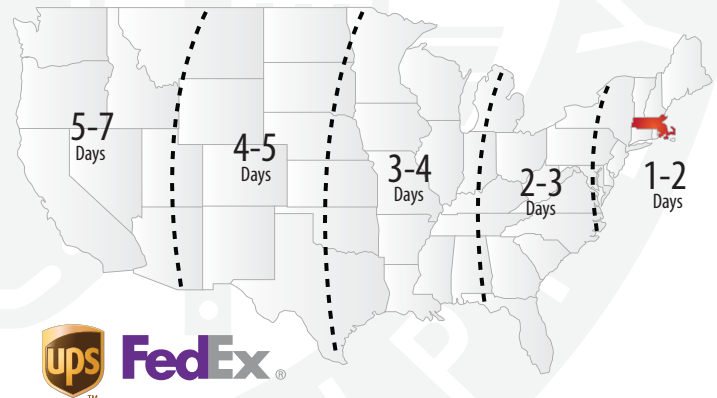

## National Delivery

We ship and receive from all over the country daily. By partnering with leading shipping companies, such as UPS and FedEx, we are able to ensure quick and cost effective delivery to anywhere in the world.



## Table of Contents

### Plumbing

Backflow Preventers .....	143	Laboratory Faucets .....	60
Boiler Relief Valves .....	139	Laundry & Utility Faucets .....	52
Bolts, Nuts, Screws & Washers .....	163	Laundry/Utility Tubs & Basins .....	96
Drains, Wastes, Cleanouts & Strainers .....	169	Lavatories .....	85
Drinking Faucets .....	13	Lavatory Faucets .....	35
Electronic Lavatory Faucets .....	48	Lavatory Pipe Covers .....	161
Emergency Mixing Valves .....	134	Metering Lavatory Faucets .....	45
Emergency Showers & Eye Washes .....	132	Mixing Valves .....	51
Faucet Accessories .....	170	Pipe Plugs & Test Plugs .....	184
Fire Equipment .....	186	Plumbing Specialties .....	181
Fire Sprinklers & Fittings .....	186	Pressure Reducing Valves .....	136
Float Valves .....	153	Pumps & Accessories .....	190
Flush Valves .....	77	Relief Valves .....	142
Garden Hose, Fittings & Accessories .....	188	Roof Flashing .....	185
Gas Connector Assemblies .....	182	Shower Heads & Accessories .....	72
Grease Interceptors .....	131	Sink Strainers .....	165
Hose Stations .....	189	Slipnuts, Flanges & Escutcheons .....	161
Hot Water Dispensers .....	33	Strainers & Hydronic Valves .....	149
Hydrants & Sillcocks .....	59	Toilet Accessories .....	173
Kitchen & Bar Faucets .....	20	Toilet Seats .....	117
Kitchen Accessories .....	170	Toilets & Urinals .....	100
Kitchen Sinks .....	125	Trap Primers .....	154
Kitchen Waste Disposers .....	128	Tub & Shower Accessories .....	171
		Tub & Shower Faucets .....	64
		Tubs & Showers .....	120



## Table of Contents

Tubular Brass .....	157	Steam Regulators .....	288
Valves, Supplies & Connectors .....	155	Steam Siphons .....	282
Washing Machine Valves .....	182	Steam Traps .....	243
Water Coolers .....	11	Thermostats .....	283
Water Treatment Systems .....	14	Vent Accessories .....	252

## Heating

Air Vents .....	248
Baseboard Heat .....	271
Boiler Accessories .....	235
Boiler Controls .....	236
Boiler Feed Units .....	242
Boilers .....	221
Chimney Venting .....	256
Circulators .....	258
Compressed Air Treatment .....	296
Controls & Regulators .....	283
Dryer Vents .....	255
Fittings .....	270
Gauges & Thermometers .....	278
Heating Condensate Pumps .....	242
Oil Tanks & Accessories .....	252
Smoke Pipe & Fittings .....	256
Space Heaters .....	276

## Valves

Ball Valves - Bronze .....	297
Ball Valves - Cast Iron .....	308
Ball Valves - PVC & CPVC .....	309
Ball Valves - Stainless Steel .....	306
Ball Valves - Steel .....	304
Boiler Valves .....	353
Bronze Gates, Globes, Checks .....	311
Butterfly Valves .....	349
Cast Steel Gates, Globes, Checks .....	328
Fire Protection Valves .....	352
Foot Valves .....	360
Forged Steel Gates, Globes, Checks .....	334
Instrumentation Valves .....	355
Iron Gates, Globes, Checks .....	323
Plug Valves .....	351



## Table of Contents

Radiator & Stop/Waste Valves.....	358	Gruvlok Couplings.....	481
Stainless Steel Gates, Globes, Checks .....	344	Heating Cable .....	516
Valve Accessories.....	361	Hollaender Speedrail Fittings.....	507

### **Pipe, Fittings, Hardware**

Acid Waste Pipe & Fittings.....	398	Malleable Iron Fittings.....	438
Aquatherm Fusion Piping.....	426	Mission Couplings.....	477
Backwater Valves - Cast Iron.....	424	Mission Couplings.....	479
Backwater Valves - PVC.....	409	Nuts, Bolts & Washers.....	517
Brass Pipe & Fittings.....	365	Nylon Tube & Fittings .....	505
Cast Iron Fittings .....	435	Pipe & Valve Identification .....	362
Cleanouts - Cast Iron .....	424	Pipe Clamps.....	480
Cleanouts - PVC .....	409	Pipe Connections & Repair.....	481
Compression Fittings & Valves.....	496	Pipe Hangers .....	518
Copper Tubing & Fittings .....	370	Pipe Insulation .....	514
CPVC Pipe & Fittings .....	414	Pipe Penetration Sealing .....	482
CTS Fittings .....	502	ProPress Pipe & Fittings.....	385
Dielectric Fittings.....	447	PVC/DWV Pipe & Fittings.....	403
Expansion Compensators.....	480	Radiant & Pex Fittings .....	484
Flexible Gas Piping .....	495	Ritmo Tools.....	431
Forged Steel Fittings.....	448	Soil Pipe, Fittings, Clamps.....	417
Garden Hose, Fittings & Accessories .....	506	Stainless Steel Nipples .....	468
Gaskets .....	512	Stainless Steel Pipe & Fittings.....	465
Grooved Pipe Fittings.....	470	Steel Couplings.....	478
		Steel Fittings .....	447
		Steel Nipples.....	460
		Steel Pipe & Fittings .....	433



## Table of Contents

Weld Fittings .....	455	Power Drills & Bits .....	580
Zeston Fittings.....	514	Power Saws .....	581

### Tools

Batteries .....	553	Pressing Tools .....	575
Brushes .....	546	Protective Gear .....	549
Cartridge Pullers .....	541	Saw Blades .....	592
Drain Cleaning .....	527	Screwdrivers & Nut Drivers.....	532
Drill Bits .....	583	Specialty Tools.....	541
Electrical Supplies - Wal-Rich Corp .....	531	Testers .....	547
Electrical Tape .....	553	Tool Boxes & Totes.....	552
Fire Equipment.....	541	Torches & Soldering Equipment .....	594
Flashlights .....	551	Tube Cutters .....	558
General Purpose Tools .....	531	Utility Knives .....	587
General Supplies.....	538	Wet/Dry Vacuums .....	575
Glass Cutters .....	574	Wrenches.....	534
Grinding Wheels.....	582		
Hand Saws.....	587		
Hex Keys .....	534		
Insulation & Heat Shields.....	598		
Knives.....	587		
Pipe Freezing & Thawing Equipment.....	579		
Pipe Tools .....	563		
Pliers, Cutters & Strippers.....	535		

### Chemicals

Abrasives .....	599
Adhesives .....	599
Anti-Freeze .....	600
Bathroom/Kitchen Cleaner.....	604
Boiler & Heating Cleaners .....	600
Boiler Sealers.....	601
Brushes.....	599
Caulk.....	602





## Table of Contents

Caulk Guns .....	602
Concentrated Cleaners .....	604
Drain & Waste Cleaners.....	604
Furnace/Stove Cement .....	603
Gasket Sealants.....	612
Hand Cleaners .....	604
Heat Barrier Spray .....	613
Leak Locators.....	606
Lubricants & Penetrants.....	606
Paint & Coatings .....	612
Pipe Sealants .....	608
PVC Primer & Cement .....	610
Sanitizing Spray .....	604
Sealants .....	602
Soldering Flux .....	613

## Repair Part Explosions

Sloan .....	614
Delta .....	618
Symmons .....	622
Chicago Faucets .....	626
T&S Brass .....	631

## Specifications

Abbreviations & Definitions.....	636
Carbon Steel Butt Weld Fitting Specifications .....	645
Carbon Steel Flange Specifications.....	645
Copper Tube Reference .....	640
Decimal Equivalents of Fractions .....	641
Drill Sizes for Pipe Taps .....	638
IPS Weights & Wall Thickness .....	641
Pipe and Water Weight per Line Foot.....	639
Refrigeration Tube Reference .....	640
Submittal: A106 Seamless A, B.....	642
Submittal: A53 A .....	643
Submittal: A53 B .....	644
Tap & Drill Sizes .....	639
Templates for Drilling Flanges.....	646
Valve Material Selection Guide.....	648

Index .....	659
Terms & Conditions .....	694
Credit Application.....	695





## Water Coolers

### Floor-Standing Water Coolers

- Classified by Underwriters Laboratories, Inc. in accordance with ANSI/NSF 61, Section 9-1997b
- Wear, moisture, perspiration, heat & sunlight resistant
- Non-corrosive satin finish stainless steel top with anti-splash ridge
- Automatic stream height regulator
- Inlet strainer
- Temperature control
- Non-pressurized stainless steel evaporator/storage tank for long life
- Hermetically sealed, positive start compressor with lifetime lubrication and built-in overload protection
- Heavy-gauge vinyl clad steel
- Single-stream self-closing projector



Part #	Mfg #	Capacity	Finish	Price
12933	S300-2E-Q	1.9 gal	Platinum	874.00
12934	S500-5E-Q	5.1 gal	Platinum	928.00

### Wall-Mount Water Coolers

- Classified by Underwriters Laboratories, Inc. in accordance with ANSI/NSF 61, Section 9-1997b
- Wear, moisture, perspiration, heat & sunlight resistant
- Non-corrosive satin finish stainless steel top with anti-splash ridge
- Automatic stream height regulator
- Inlet strainer
- Temperature control
- Non-pressurized stainless steel evaporator/storage tank for long life
- Hermetically sealed, positive start compressor with lifetime lubrication and built-in overload protection

#### Deluxe Wall-Mount Water Cooler

- Exclusive Halsey Taylor Double Bubbler™
- 28" High cabinet
- Heavy-gauge vinyl clad steel
- Pushbutton actuation mechanism
- Mounts with all connections concealed
- Easy-Flex™ bubbler available
- Available without refrigeration
- Stainless steel receptor
- Air condenser cooling
- Factory -installed coffee server available



Part #	Mfg #	Capacity	Finish	Price
12944	WM8A-Q	8 gal	Platinum	1075.00

### ADA Wall-Mount Water Cooler - Rounded Edge Push Bars

- Heavy-gauge vinyl clad steel
- Fine mesh strainer on water inlet line
- Molded 2-toned gray polymer with softly rounded edges
- Self-closing light-touch push bars require minimal pressure to activate
- Easy-Flex™ bubbler available



Part #	Mfg #	Capacity	Finish	Price
220412	HTV8-Q	8 gal	Gray Polymer	819.00

### ADA Wall-Mount Water Cooler - Front & Side Push Bars

- Heavy-gauge vinyl clad steel
- Fine mesh strainer on water inlet line
- Push bar actuation mechanism with raised letters for the visually handicapped



Part #	Mfg #	Capacity	Finish	Price
12914	HAC8FS-Q-C HILD	8 gal	Stainless Steel	875.00

### ADA Wall-Mount Water Cooler - Bi-Level

- Heavy-gauge vinyl clad steel
- Fine mesh strainer on water inlet line
- Push bar actuation mechanism with raised letters for the visually handicapped



Part #	Mfg #	Capacity	Finish	Price
46388	HAC8BLFS-Q- ADA	8 gal	Stainless Steel	1540.00



## Water Coolers

Plumbing

### ADA Wall-Mount Recessed Water Cooler - Bi-Level

- For additional specification of the cooling unit, see Model SJ8 Remote Chiller



Part #	Mfg #	Capacity	Finish	Price
111474	OVL-II-SER-Q		Stainless Steel	4312.00

### ADA Wall-Mount Recessed Water Cooler - Bi-Level

- Exclusive Halsey Taylor Double Bubbler
- Standard finish is satin finish stainless steel
- Automatic stream regulator
- Meets requirements of ADA



Part #	Mfg #	Capacity	Finish	Price
37639	OVL-II-SEB-P		Stainless Steel	2947.00

### Remote Chiller - Narrow

- Ideal where space is limited
- Adjustable thermostat preset to 50°F
- Electrical leads 120V
- Tube-on-tube evaporator chiller, covered by 10-year limited warranty
- Plumbing connections: 3/8"OD inlet and outlet



Part #	Mfg #	Capacity	Finish	Price
12936	SJ8-Q	8 gph	Steel	980.00

### Bottle Filling Stations

#### EZH20 Bottle Filling Station

EZH20 reduces our dependency on plastic water bottles, provides a rapid fill of filtered water to quench thirst and help minimize disposable plastic bottle waste in the environment.

- The EZH20 fill rate\* is 1.1-1.5 gpm; 3 times faster than a traditional drinking fountain
- One-handed operation allows for a quick fill between activities
- The electronic sensor provides touchless, sanitary operation; just place and fill
- New WaterSentry® Plus 3000 gallon filter is included (NSF approved for taste, odor and lead reduction)
- Integrated Silver Ion Anti-microbial protects against mold and mildew growth
- Innovative Green Ticker counts the quantity of 16 oz. bottles saved from land fills for non-refrigerated units and 12 oz. bottles saved for refrigerated units



Part #	Mfg #	Description	Price
931744	LZS8WSLK	EZH20 Bottle Filling Station	1167.32

### Vitreous China Drinking Fountains

#### Millbrook Vitreous China Drinking Fountain

- The Millbrooke wall-mount drinking fountain offers a streamlined, wall-mount design suitable for users of all capabilities.
- Includes:
  - Supply fitting
  - 1-1/4" trap & strainer

THE BOLD LOOK OF **KOHLER**



Part #	Mfg #	Description	Price
13231	K-5264-0	Drinking Fountain	831.85



## Water Coolers



### Glenbrook™ Semi-Recessed Fountain

- With its trim, semi-recessed design, the Glenbrook drinking fountain provides an ideal solution for high-traffic areas.
- Includes:
  - Supply fitting
  - 1-1/4" trap & strainer

THE BOLD LOOK OF **KOHLER**®



Part #	Mfg #	Description	Price
13232	K-5293-0	Drinking Fountain	1160.75
13233	K-5295-0	Cuspidor	967.40



### Drinking Fountain

- ADA MVP™ Metering handle
- Metal projector head
- 1/2" NPSM Coupling nut for 3/8" or 1/2" flexible riser
- Vandal resistant manual volume control
- Anti-rotational pins
- MVP™ Cartridge



Part #	Mfg #	Finish	Price
47045	748-665CP	Chrome-Plated	168.30



### Drinking Faucets

#### 1-Handle Self-Closing Drinking Faucet

- Cast Brass Drinking Faucet
- 1/2 -14 NPS Male Shank
- Self-Closing Lever Handle
- Replaceable Seat
- PVD Polished Chrome



Part #	Mfg #	Description	Price
12086	0364-L	ADA Lever, CP	143.06

#### Drinking Faucet Head

- Cast Brass Drinking Faucet Head
- 3/8 - 18 NPS Female Thread
- With Stream Control
- PVD Polished Chrome



Part #	Mfg #	Description	Price
12087	0377	Includes Stream Control, CP	48.16



## Join our e-mail newsletter!

Receive special deals and promotions, new product announcements, contests and more in your inbox every month!



## Filtration Systems

Plumbing

### Whole-House Water Filter Systems -

- Installed where the main water line enters the house
- Conforms to public health requirements for water purification
- Cartridges should be replaced every 3 - 4 months or sooner when noticeable pressure drop occurs
- Universal replacement cartridges available in different grades of porosity

#### Single Cartridge Valve-in-Head Plastic Filter Housings

- Standard diameter - 4-9/16"
- For 1-2 bathroom homes
- Cold water application
- Pressure tested high-impact plastic design
- Built-in shut-off valve with pressure relief
- 3/4" NPT Pipe connection
- Maximum flow rate: 8 gpm
- Maximum water temperature: 100°F
- "Aqua-Grip" filter wrench included
- Includes AP110 cartridge with 5 micron nominal rating for dirt, rust & sediment
- Made from FDA CFR-21 compliant materials



Part #	Mfg #	Housing	Height	Price
12703	AP101T	Clear	14-1/4"	142.37

#### Single Cartridge Plastic Housing System

- Standard diameter - 4-9/16"
- Cold water application
- Pressure tested high-impact plastic design
- 3/4" NPT Pipe connection
- Maximum flow rate: 8 gpm
- Maximum water temperature: 100°F
- Maximum water pressure: 125 psi
- "Aqua-Grip" filter wrench included
- Includes AP110 cartridge with 5 micron nominal rating for dirt, rust & sediment
- For use with industry standard size cartridges: 2-1/2" to 3" OD x 9-3/4"



AP11T AP11S

Part #	Mfg #	Housing	Height	Price
12701	AP11T	Clear	13-5/8"	114.87

### Dual Cartridge Valve-in-Head Plastic Filter Housing

- Standard diameter - 4-9/16"
- For 3-4 bathroom homes
- Cold water application
- (2) Cartridges high; cartridges sold separately
- Pressure tested high-impact plastic design
- Built-in shut-off valve with pressure relief
- Center alignment post
- 3/4" NPT Pipe connections
- Maximum flow rate: 16 gpm
- Maximum water temperature: 100°F
- "Aqua-Grip" filter wrench included
- Made from FDA CFR-21 compliant materials



Part #	Mfg #	Housing	Height	Price
12704	AP102T	Clear	24-1/4"	195.83

### Standard Diameter Replacement Cartridge

- For standard diameter models
- Removes dirt, rust and sediment
- Flow rate: 8 gpm
- Cold water (up to 100°F)
- Single action for sediment reduction
- 9-3/4" High x 2-5/8" diameter
- Made from FDA (CFR-21) compliant materials
- (2) Per package

Part #	Mfg #	Load	Micron Rating	Price
43371	AP1001	Extra Fine	1	43.85
12715	AP1003	Fine	3	33.26
12713	AP110	Normal	5	12.47
12718	AP117	Normal	5	32.12
12719	APS117	Normal	5	40.49
12720	AP124	Heavy	50	13.74



## Filtration Systems

### AP902 Water Filtration System

- The CUNO Aqua-Pure AP902 Water Filtration System is a single cartridge system which helps provide consistent high quality water for whole house filtration at flow rates up to 20 gpm.
- Filtration: 5 Micron Nominal
- Dimensions: 25-1/16" L x 4-1/2" W
- Maximum Flow Rate: 20 gpm (75.7 lpm)
- Inlet/Outlet Size: 1" NPT
- Temperature Range: 40-100 F (4.4-37.8 C)
- Pressure Range: 25-125 psi (172-862 kPa)
- Installation: Cold Water Only
- Filter Capacity: 100,000 Gallons / One-Year
- Includes: Mounting Bracket



Part #	Mfg #	Housing	Height	Price
933262	AP902	Opaque	25-1/16"	285.76

### AP902 Replacement Cartridge

Part #	Mfg #	Description	Price
933263	AP910R	Reduces Sediment/Chlorine Taste & Odor (5 Micron)	148.39
933264	AP917R	Reduces Sediment/Chlorine Taste & Odor (5 Micron)	202.86

### Big Aqua 800 Series Plastic Housings - Single Cartridge

- For large 2-3 bath homes & commercial applications
- Reduces sediment and rust, chlorine taste and odor
- Pressure tested high-impact plastic
- 1" NPT Pipe connections
- Maximum flow rate: 20 gpm
- Maximum temperature 100°F
- Maximum pressure 100 psi
- "Aqua-Grip" filter wrench included; cartridges sold separately



Part #	Mfg #	Housing	Height	Price
12709	AP801	Opaque	13-15/16"	111.04

### AP801 Replacement Cartridge

- Reduces dirt, rust and sediment
- Cold water up to 100°F; flow rate: 20-28 gpm
- (1) Per package



Part #	Mfg #	Load	Micron Rating	Price
156405	AP811	Medium	25	43.45
154889	AP814	Coarse	50	33.02
898365	AP817	Normal*	25*	57.45

\* Also Reduces Chlorine Taste and Odor; 10 gpm Flow Rate

### Big Aqua 800 Series Plastic Housings - Dual Cartridge

- For large homes (4+ bath) & commercial applications
- Reduces sediment and rust, chlorine taste and odor
- Built-in pressure relief
- Pressure tested high-impact plastic design
- 1" NPT Pipe connections
- Maximum flow rate: 45 gpm
- Maximum temperature: 100°F
- Maximum pressure: 100 psi
- "Aqua-Grip" filter wrench included; cartridges sold separately



Part #	Mfg #	Housing	Height	Price
144008	AP802	Opaque	23-5/8"	148.61

### AP802 Replacement Cartridge

- Reduces dirt, rust and sediment
- Cold water up to 100°F; flow rate: 45-60 gpm
- Cartridge dimensions: 19-7/8" high x 4-5/7" diameter
- (1) Per package



Part #	Mfg #	Load	Micron Rating	Price
144009	AP810-2	Normal	5	62.99
156406	AP811-2	Medium	25	69.61

### Single Cartridge Stainless Steel Housing

- Standard diameter - 4-5/32"
- Cold water application
- Heavy duty stainless steel housing
- 3/4" NPT Pipe connection
- Maximum flow rate: 8 gpm
- Maximum water temperature: 100°F
- Maximum water pressure: 300 psi
- "Aqua-Grip" filter wrench included
- Includes AP110 cartridge with 5 micron nominal rating for dirt, rust & sediment
- For use with industry standard size cartridges: 2-1/2" to 3" OD x 9-3/4"



Part #	Mfg #	Housing	Height	Price
12711	AP1610	Stainless	12-7/32"	299.74



## Filtration Systems

Plumbing

### Standard Diameter Replacement Cartridge

- For standard diameter models
- Removes dirt, rust and sediment
- Flow rate: 8 gpm
- Cold water (up to 100°F)
- Single action for sediment reduction
- 9-3/4" High x 2-5/8" diameter
- Made from FDA (CFR-21) compliant materials
- (2) Per package

Part #	Mfg #	Load	Micron Rating	Price
43371	AP1001	Extra Fine	1	43.85
12715	AP1003	Fine	3	33.26
12713	AP110	Normal	5	12.47
12718	AP117	Normal	5	32.12
12719	APS117	Normal	5	40.49
12720	AP124	Heavy	50	13.74

### AP Easy CS-FF Full Flow Water Filter

- The AP Easy CS-FF works just like any other under-sink filtration system to provide better drinking water by reducing chlorine taste and odor, sediment but with the added bonus of not having to install or use a separate faucet! The Aqua-Pure AP Easy CS-FF Full Flow Drinking Water System provides full flow filtration to your existing faucet, eliminated the need for an extra faucet.
- 5 Micron Rating
- 2,000 Gallon Cartridge Life
- Built-in Bypass Valve
- Everything included--no additional parts needed for most installations
- NSF Tested & Certified
- Dimensions: 11-7/8" x 3-1/4" x 4"
- Weight: 2.2 lbs
- Flow Rate : 2 Gallons Per Minute
- NSF Standard 42 Certified
- Fits 3/8" Copper or Plastic Water Line



Part #	Mfg #	Housing	Height	Price
933260	EASY-CS-FF	Opaque	11-7/8"	99.03

### AP Easy Replacement Cartridge

Part #	Mfg #	Load	Micron Rating	Price
933261	C-CS-FF	Normal	5	47.68

### Under-Sink Full Flow Compact Filter Systems

- Reduces dirt, rust, sediment and chlorine taste and odor
- Pressure tested high-impact plastic design
- Effective filter protection for up to 2,000 gallons
- 3/8" NPT Pipe connections
- Maximum flow rate: 2 gpm
- Maximum water temperature: 100°F
- Maximum water pressure: 125 psi
- 5 Micron rating nominal
- Includes AP217 sediment filter



Part #	Mfg #	Height	Diameter	Price
12705	AP200	9-3/16"	6-3/32"	136.31

### AP200 Replacement Cartridge

Part #	Mfg #	Description	Price
12722	AP217	Reduces Sediment/Chlorine Taste & Odor (5 Micron)	39.52

### Triple Action Full Flow Valve-in-Head Point of Use Filters

- Reduces dirt, rust, sediment; chlorine taste and odor; and scale build up in ice makers
- 1/4 -turn filter change-out
- Sanitary quick change (SQC)
- Food grade scale inhibitor
- Internal shut-off valve
- Pressure tested high-impact plastic design
- 2000 Gallon capacity
- 3/8" NPT Vertical Pipe connection
- Maximum flow rate: 2 gpm
- 5 Micron rating nominal
- Includes AP517 cartridge



Part #	Mfg #	Height	Diameter	Price
138867	AP510	11-1/16"	3-5/8"	175.51

### AP510 Replacement Cartridge

Part #	Mfg #	Description	Price
12724	AP517	Reduces Sediment/Chlorine Taste & Odor/Scale (5 Micron)	73.50





## Filtration Systems

### Dual Stage Carbon Block Filtration Systems

- Reduces sediment, chlorine taste & odor, lead, protozoan cyst & VOCs & MTBE leached from soils
- 1/4" Quick connect fittings
- Automatic shut-off after 625 gallons
- 0.5 Micron rating nominal
- Maximum flow rate: 0.6 gpm
- Maximum water temperature: 100°F
- Maximum water pressure: 125 psi
- Includes: Installation hardware, faucet & pipe connections, (2) cartridge DW80/90 set



Part #	Mfg #	Dimensions	Price
12729	AP-DWS1000	11" x 15-1/2" x 4-1/2"	423.25

### AP-DWS1000 Replacement Cartridge

- (2) Per package

Part #	Mfg #	Description	Price
12730	AP-DW80/90	Reduces Sediment/Chlorine Taste & Odor/Lead/Parasitic Protozoan Cyst (0.5 & 1 Micron)	144.13

### Replacement Cartridges for Drinking Water System Filters



APDW85



AP117

Part #	Mfg #	Description	Price
119763	AP-DW85	Taste & Odor Filter	144.13
12718	AP117	Taste & Odor Filter	32.12
12719	APS117	Taste & Odor Filter	40.49

### Ice Maker Water Filter

- Reduces chlorine, taste & odor; & inhibits scale build up
- Cold water application
- Pressure tested high impact plastic design
- High absorption activated carbon media
- 1/4" Quick connect fittings included
- 1500 Gallon capacity
- Maximum flow rate: 0.5 gpm
- Maximum operating temperature: 100°F
- Maximum pressure: 125 psi
- 5 Micron nominal rating & food grade scale inhibitor



Part #	Mfg #	Height	Diameter	Price
12708	AP717	8-3/8"	2-5/16"	33.66

### Ice Maker Replacement Cartridge

Part #	Mfg #	Description	Price
12723	AP317	For AP300 & AP305	68.48

### Water Filtration Parts & Accessories

#### Water Test Kit

Part #	Mfg #	Description	Price
12726	WSB	Water Sample Bottle Test Kit (formerly APAKT)	12.40

#### Gasket Kit

Part #	Mfg #	Description	Price
182372	55480-01C	For AP101 & AP102	9.73

#### O-Ring

Part #	Mfg #	Description	Price
45614	34737-13C	For All Metal Filters	4.05
36886	36851-31C	For AP200	5.50
92047	63597-174C	3-1/2" for AP11S, AP11T, AP12S, AP12T, AS26T, AP51T, AP101S, AP101T, AP102S, AP102T	3.65

#### Wrenches

Part #	Mfg #	Description	Price
170303	AP-WRNCH	For AP11S, AP11T, AP101S, AP101T, AP12S, AP26T, AP51T, AP102S, AP102T	7.22
207871	63562-01C	For AP400, AP1610, AP2610, SS1, SS1HA, SS2HA, SS2HB, SSTSD	4.05



## Filtration Systems

### Taste, Odor, and Chlorine Reduction Filters

#### Universal Size Filter Cartridges

Model	Nominal Micron Reading	Chlorine Reduction Gallons/Liters	Flow Rate
<b>AP117</b>	5	10,000 (37,854)	3 gpm (11 lpm)
<b>APS117 (Scale)</b>	5	10,000 (37,854)	3 gpm (11 lpm)

#### Large Diameter Cartridges

Model	Nominal Micron Reading	Chlorine Reduction Gallons	Flow Rate	Length
<b>AP815</b>	5	40,000 (151,416)	5 gpm (19 lpm)	9 3/4" (24.8 cm)
<b>AP815-2</b>	5	80,000 (302,832)	10 gpm (38 lpm)	20" (50.8 cm)

### Dirt, Rust, and Sediment Filter Cartridges

#### Universal Size Filter Cartridges

Model	Nominal Micron Reading	Flow Rate
<b>AP1001</b>	1	8 gpm (30 lpm)
<b>AP1003</b>	3	8 gpm (30 lpm)
<b>AP110<sup>1</sup></b>	5	8 gpm (30 lpm)
<b>AP111<sup>1</sup></b>	25	8 gpm (30 lpm)
<b>AP124<sup>1</sup></b>	50	8 gpm (30 lpm)

<sup>1</sup> Available in multi-length sizes

#### Large Diameter Cartridges

Model	Nominal Micron Reading	Flow Rate	Length
<b>AP810</b>	5	20-28 gpm	9-3/4" (24.8 cm)
<b>AP810-2</b>	5	45-60 gpm	20" (50.8 cm)
<b>AP811</b>	25	20-28 gpm	9-3/4" (24.8 cm)
<b>AP811-2</b>	25	45-60 gpm	20" (50.8 cm)
<b>AP814</b>	50	20-28 gpm	9-3/4" (24.8 cm)
<b>AP814-2</b>	50	45-60 gpm	20" (50.8 cm)



# Filtration Systems

Cartridge Cross-Reference Chart

Plumbing

Drnk	Point of Use			Whole House							Housings		
	APDWS-1000	EASY-LSFF	AP510	AP200	AP1610	AP902	AP802	AP801	AP11T	AP102T			AP101T
					○				○	○	○	AP1001	Dirt / Rust
					○				○	○	○	AP1003	
					●				●	○	●	AP110	
					○				○	○	○	AP111	
					○				○	○	○	AP124	
				○								AP205	
								○				AP810	
							○					AP810-2	
								○				AP-811	
							○					AP811-2	
								○				AP814	
							○					AP814-2	
						○						AP910R	
						○						AP917R	
				●								AP217	Taste / Odor
				○					○	○	○	AP117	
								○				AP815	
							○					AP815-2	
		○										AP EASY C-CS-FF	Scale
					○				○	○	○	AP420	
			●									AP517	
				○								APS217	
				○					○	○	○	APS117	
●												AP-DW 80/90	Chemicals & Lead

● Included with filter ○ Fits this housing

Cartridges

Prices & specifications are subject to change.

Our office hours are 7am to 4:30pm and counter hours 6am to 4:30pm Monday through Friday.



## Kitchen Faucets

Plumbing

### Single-Handle Kitchen Faucets

#### Marathon™ 1-Handle Deck-Mount Lavatory/Kitchen Faucets with 10" Cast Brass Spout

- Solid brass body construction
- 3/8" OD Copper supply tube inlets
- 8" Center set deck cover plate
- Volume control
- Temperature limit stop
- Mounting hardware included



Part #	Mfg #	Description	Cartridge	Aerator	Finish	Price
124114	2300-8CP	1-Hole, Metal ADA Lever	Ceramic Mixing	E12	CP	369.67
128659	2301-8CP	1-Hole, Metal ADA Lever, Side Hose & Spray	Ceramic Mixing	E12	CP	404.85

### Two-Handle Kitchen Faucets

#### 2-Handle Concealed Deck-Mount Kitchen Faucets with GN8A Rigid/Swing Gooseneck Spout & Side Spray

- Solid brass body construction
- 3/8" OD Copper supply tubes
- Mounting hardware included
- Handles indexed hot & cold
- Handle/spout options available \*



Part #	Mfg #	Description	Cartridge	Aerator	Finish	Price
12100	200-AGN8AE3-317CP	8"cc, 317 Metal ADA Wrist Blade Handles	Quatern™	E3	CP	278.05
137743	200-ALESSSPT&HDLCP	8"cc, Less Spout & Handles	Quatern™	-	CP	203.28

#### 2-Handle Concealed Deck-Mount Kitchen Faucets with L9 Swing Spout

- Solid brass body construction
- 1/2" NPSM Supply inlets with coupling nuts for 3/8" or 1/2" flexible risers
- Mounting hardware included
- Handles indexed hot & cold
- Handle/spout options available \*



Part #	Mfg #	Description	Cartridge	Aerator	Finish	Price
155074	201-ACP	8"cc, 369 Metal ADA Levers	Quatern™	E3	CP	199.46
140592	201-ALESSSPT&HDLCP	8"cc, Less Spout & Handles	Quatern™	-	CP	145.41

#### 2-Handle Concealed Deck-Mount Faucet with GN8A Rigid/Swing Gooseneck Spout

- Solid brass body construction
- 1/2" NPSM Supply inlets with coupling nuts for 3/8" or 1/2" flexible risers
- Mounting hardware included
- Handles indexed hot & cold
- Handle/spout options available \*



Part #	Mfg #	Description	Cartridge	Aerator	Finish	Price
36795	201-AGN8AE3-317CP	8"cc, 317 Metal ADA Wrist Blade Handles	Quatern™	E3	CP	217.66

Prices & specifications are subject to change.



## Kitchen Faucets

Plumbing

### 2-Handle Concealed Deck-Mount Faucet with GN8A Rigid/Swing Gooseneck Spout

- Solid brass body construction
- 1/2" NPSM Coupling nut for 3/8" or 1/2" flexible riser
- Mounting hardware included
- Handles indexed hot & cold
- Handle/spout options available \*



Part #	Mfg #	Description	Cartridge	Aerator	Finish	Price
36841	786-SWGN8AE3-CP	8"cc, 317 Metal ADA Wrist Blade Handles, Swivel Connect	Quaturn™	E3	CP	232.17

### 2-Handle Concealed Deck-Mount Faucet with GN8A Rigid/Swing Vacuum Breaker Gooseneck Spout

- Solid brass body construction
- 1/2" NPSM Coupling nut for 3/8" or 1/2" flexible riser
- Mounting hardware included
- Handles indexed hot & cold
- Handle/spout options available \*



Part #	Mfg #	Description	Cartridge	Aerator	Finish	Price
40857	786-SWGN8BVBE7CP	8"cc, 317 Metal ADA Wrist Blade Handles, Swivel Connect	Quaturn™	E7	CP	356.93

### 2-Handle Concealed Deck-Mount Kitchen Faucets with L8 Cast Swing Spout

- Solid brass body construction
- 1/2" NPSM Coupling nut for 3/8" or 1/2" flexible riser
- Mounting hardware included
- Handles indexed hot & cold
- Handle/spout options available \*



Part #	Mfg #	Description	Cartridge	Aerator	Finish	Price
12187	1100-CP	8"cc, 1000 Metal ADA Wing Canopy Handles	Quaturn™	E3	CP	207.65
170204	1100-LESSSPTCP	8"cc, 1000 Metal ADA Wing Canopy Handles, Less Spout	Quaturn™	-	CP	150.21
12188	1102-CP	8"cc, 1000 Metal ADA Wing Canopy Handles, w/Side Spray	Quaturn™	E3	CP	255.04

### 2-Handle Concealed Deck-Mount Kitchen Faucet with L9 Cast Swing Spout

- Solid brass body construction
- 1/2" NPSM Coupling nut for 3/8" or 1/2" flexible riser
- Mounting hardware included
- Handles indexed hot & cold
- Handle/spout options available \*



Part #	Mfg #	Description	Cartridge	Aerator	Finish	Price
36606	1201-ACP	8"cc, 1000 Metal ADA Wing Canopy Handles	Quaturn™	E3	CP	205.61

Prices & specifications are subject to change.

You can check stock availability, pricing and place orders online at [www.MetPipe.com](http://www.MetPipe.com).



## Kitchen Faucets

Plumbing

### 2-Handle Deck-Mount Sink Faucet with GN2A Rigid/Swing Gooseneck Spout

- Solid brass body construction
- 3/8" OD Copper supply tubes
- Mounting hardware included
- Handles indexed hot & cold



Part #	Mfg #	Description	Cartridge	Aerator	Finish	Price
12098	50-CP	1-Hole, 369 Metal ADA Levers	Quatum™	E3	CP	181.95

### 2-Handle Deck-Mount Sink Faucet with DB6A Rigid/Swing Double Bend Spout

- Solid brass body construction
- 1/2" NPSM Coupling nut for 3/8" or 1/2" flexible riser
- Mounting hardware included
- Handles indexed hot & cold
- Handle/spout options available \*



Part #	Mfg #	Description	Cartridge	Aerator	Finish	Price
35952	527-CP	8"cc, 369 Metal ADA Levers	Quatum™	E1	CP	177.47

### 2-Handle Deck-Mount Sink Faucet with GN2A Rigid/Swing Gooseneck Spout

- Polished chrome plated solid brass construction.
- 5 1/4" Center to Center Rigid / Swing Gooseneck Spout.
- 2.2 GPM (8.3 L/min) Pressure Compensating Softflo Aerator.
- 4" Metal Wristblade handle(s) with Sixteen Point Tapered Broach and Secured Blue and Red Buttons.
- Quatum™ rebuildable compression cartridge, opens and closes 90°, closes with water pressure, features square tapered stem.
- Flexible stainless steel hoses allow handle placement from 6" - 26".
- 1/2" NPSM Supply Inlets and Coupling
- Nut for 3/8" or 1/2" Flexible Riser. Mounting hardware included.



Part #	Mfg #	Description	Cartridge	Aerator	Finish	Price
948927	786-HZGN2AE3317	12"cc, 317 Metal ADA Wrist Blade Handles	Quatum™	E3	CP	216.41

### 786 - With Third Water Inlet Connection

- Concealed Kitchen Faucet with Third Water Inlet Connection

Part #	Mfg #	Description	Cartridge	Aerator	Finish	Price
178146	786-TWGN2AE3	GN2A 5-1/4" Gooseneck Spout	E3	317		249.84
199136	786-TWGN2BVBE7	GN2BVB 6" Vac Breaker Gooseneck Spout	E7	317		376.86



## Commercial Kitchen Faucets



### Commercial Faucets

#### 2-Handle Wall-Mount Pot Filling Faucet with L9 Swing Spout and Pre-Rinse Spray Valve

- Solid brass body construction
- 5' Flexible stainless steel hose with insulated handle
- "GC" Adjustable 1/2" FNPT supply arms with integrated checks
- 81L - Self-closing angled spray
- Mounting hardware included
- Handles indexed hot & cold



Plumbing

Part #	Mfg #	Description	Cartridge	Aerator	Finish	Price
108657	509-GCLCP	7-1/4" - 8-3/4"cc, 369 Metal ADA Levers	Quaturn™	E3	CP	442.66

### Pre-Rinse Faucets

#### 2-Handle Deck-Mount Pre-Rinse Spray with 23" Spring Guide Riser

- 1/4" MNPT Check tail pieces
- Integrated pipe support & hook assembly
- 44" Flexible stainless steel hose with insulated handle



Part #	Mfg #	Description	Cartridge	Valve	Finish	Price
41252	919-LCP	3-1/2"cc, 369 Metal ADA Levers	Quaturn™	80L	CP	396.66

#### 2-Handle Adjustable 7-1/4" - 8-3/4" Center Wall Mounted Pre-Rinse Spray with 23" Spring Guide Riser

- 3/8" Offset Adjustable Supply Arms with 1/2" NPT Female Thread Inlet and Integral Check
- 2-3/8" Metal Lever Handles with Secured Red and Blue Service Buttons
- 1.42 GPM (5.4 L/min) Self Closing Spray Valve
- 23" Riser with Spring Guide



Part #	Mfg #	Description	Cartridge	Aerator	Finish	Price
40443	510-GC	7-1/4"-8-3/4"cc, 369 Metal ADA Levers	Quaturn™	80L	CP	398.58

### Hand Sprays for Pre-Rinse Faucet

- Compatible with Fisher and T&S hoses
- Rubber bound spray head
- Ergonomic actuator handle with hold down ring
- 3/4" - 14 UNS Male Inlet



Part #	Mfg #	Description	Flow	Price
108322	80-HCP	Hose Reel Spray Valve	2.5 GPM @ 60 psi	53.84

Prices & specifications are subject to change.

We offer a variety of GREEN products such as flush valves, faucets, showerheads & more!



## Commercial Kitchen Faucets

### Adapta 1-Handle Kitchen Faucet with L9 Swing Spout

- Solid brass body construction
- Fits 1-1/16" - 18 UNEF Male body outlet
- 3/8" FNPT Outlet
- Mounting hardware included



Part #	Mfg #	Description	Cartridge	Aerator	Finish	Price
108750	613-ACP	1-Hole, 369 Metal ADA Plain Indexed Lever	Quaturn™	E1	CP	134.62

### Handles

- Sets of (2) chrome-plated handles
- Each set includes Hot & Cold index buttons



Part #	Mfg #	Description	Price
21182	317-PRJKCP	4" ADA Wrist Blade Handles	52.97
21188	369-PRJKCP	2-3/8" Metal ADA Levers	20.36
221203	390-PRJKCP	2-3/8" Metal ADA Levers w/Plain Index Buttons & VR/NVR Screws	22.97

### Spouts

- Fits 1-1/16" - 18 UNEF male body outlet
- Chrome-plated



Part #	Mfg #	Description	Price
21125	GN8AJKCP	Rigid/Swing Gooseneck Spout, 11-1/4"H, 8" Reach, 13/16"-24 Male Outlet	54.65
38648	HA8JKCP	High Arch Swing Spout w/E12 Softflo® Aerator, 9-3/8"H, 8" Reach	82.48
21132	L9JKCP	Swing Spout, 6-1/2"H, 9-1/2" Reach, E3 Pressure Compensating Softflo® Aerator	46.73

## Electronic Billing

Save time and get your invoices faster online, by email or fax!

Sign up today:  
<http://ebilling.metpipe.com>





## Commercial Kitchen Faucets



### Pre-Rinse Units

#### 2-Handle Mixing Faucet with Swing Nozzle & Spray Unit

- Add-on faucet with 12" swing nozzle (B-0156)
- 108" Overall length of hose and spray unit
- Angle spray valve with automatic shut off (B-0107-035)
- Flexible stainless steel hose (B-0104-H)
- Hanger hook holds hose when not in use (B-0166)
- 1/2" NPT Female eccentric flanged inlets
- Built-in spring checks prevent cross flow of water
- EP Act 2005 Compliant
- Handle options available



Part #	Mfg #	Description	Price
14564	B-0175	8"cc Wall-Mount	689.77

#### Easy Install 2-Handle Deck-Mount Pre-rinse Unit

- Single hole base faucet (002824-40) with "pop and lock" riser installation feature
- 45" High, 14" Spread
- 19-3/8" Clearance
- Spray valve (B-0107)
- 24" Riser model (000372-40)
- Flexible stainless steel hose (B-0044-H)
- 18" Flexible inlets with 1/2" couplings
- 1/2" NPT Male inlets
- Universal body accepts flex lines & spreader yoke
- EP Act 2005 Compliant

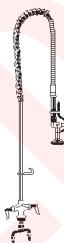

Part #	Mfg #	Description	Price
14544	B-0113	Less Bracket B-0109-01	415.34

#### Easy Install 2-Handle Wall-Mount Pre-rinse Faucet

- 8"cc Wall-mount faucet (002832-40) with "pop and lock" riser installation feature
- 35-1/2" High
- 15" Overhang
- Spray valve (B-0107)
- 18" Riser model (000369-40)
- Flexible stainless steel hose (B-0044-H)
- 1/2" NPT Female eccentric flanged inlets



Part #	Mfg #	Description	Price
14550	B-0133	Less Bracket B-0109-01	442.60

### Wall Bracket for Pre-rinse Units

- 6" Wall bracket



Part #	Mfg #	Description	Price
14536	B-0109-01	Fits 3/8" Pre-rinse Riser	54.89
14542	B-0110	Fits 1/2" Pre-rinse Riser	73.83

### Add-On Faucet for Pre-rinse Units

- Adds swinging nozzle to Pre-rinse units
- Includes 3" nipple for installation on existing base faucet



Part #	Mfg #	Description	Price
14554	B-0155-LN	Less Nozzle	93.01

### Pre-rinse Spray with Flexible Stainless Steel Hose

- Designed for heavy-duty use in industrial kitchens
- Automatic shut-off valve with spray head (B-0107)
- 3' Flexible stainless steel hose (B-0044-H)
- 1/2" NPT Male inlet
- 48" Overall length

Part #	Mfg #	Description	Price
14522	B-0100	Spray Valve & SS Hose	185.50

### Pre-rinse Spray Valve

- Used on most T&S Pre-rinse units
- Connects directly to T&S flexible stainless steel hose or Roto-flex handle assembly



Part #	Mfg #	Description	Price
14533	B-0107	Standard Spray Valve	87.41

### Replacement Hoses

- Flexible stainless steel hose



Part #	Mfg #	Length	Price
14515	B-0020-H	20"	73.46
14516	B-0026-H	26"	74.94



## Commercial Kitchen Faucets

Plumbing

### Pre-Rinse Units (Continued)

#### Replacement Hoses

Part #	Mfg #	Length	Price
14517	B-0044-H	44"	82.54
14521	B-0068-H	68"	101.83

### Glass & Pot Fillers

#### Pedestal Push-Back Single Glass Filler

- Adjustable flange on shank of pedestal
- 1/2" IPS Male shank 2" long
- Base of flange to outlet is 8"
- Translucent blue Lexan push back arm
- Volume regulator & instantaneous shut-off



Part #	Mfg #	Description	Price
14762	B-1210	Pedestal Push Back	159.12

#### Hook Nozzle Pot Fillers

- For use on large pots & steam kettles
- Automatic shut-off valve
- Retaining ring for continuous water flow
- 1/2" IPS Male inlet



Part #	Mfg #	Description	Price
14526	B-0102-A	Hook Nozzle Pot Filler	187.11

### Swivel Base Faucets

#### 1-Handle Deck-Mount Single Pantry Faucet

- Lever handle
- Specify hot or cold
- Swivel base
- 1/2" IPS Single shank & 1/4" IPS union type tailpiece



Part #	Mfg #	Description	Price
14571	B-0205-LN	Less Nozzle	134.68

#### 2-Handle Deck-Mount Double Pantry Faucet

- Lever handles
- Swivel base
- 1-1/8" Shank & 1/4" IPS tail pieces



Part #	Mfg #	Description	Price
14569	B-0200-LN	4"cc less Nozzle	166.42

### 1-Handle Wall-Mount Mixing Faucets

- 4-Arm handle
- Specify hot or cold
- Swivel base
- 1/2" IPS Female flanged inlet



Part #	Mfg #	Description	Price
14574	B-0210-LN	Less Nozzle	103.68

### 2-Handle Wall-Mount Mixing Faucets

- Lever handles
- 8" centers
- Swivel base
- 1/2" IPS Eccentric flanged female inlets

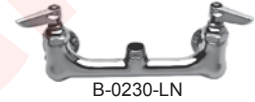

Part #	Mfg #	Description	Price
14587	B-0230-LN	8"cc less Nozzle	209.38
14588	B-0231	8"cc with 062X 12" Swing Nozzle	202.78

### 2-Handle Deck-Mount Mixing Faucets

- Lever handles
- Swivel base
- 1/2" IPS Eccentric flanged female inlets



Part #	Mfg #	Description	Price
14583	B-0225-LN	4"cc less Nozzle	160.60
14578	B-0220-LN	8"cc less Nozzle	172.28

### Work Board Faucets

#### 2-Handle Deck-Mount Work Board Faucets

- Bronze body
- Removable seats
- Chrome plated escutcheon
- 1-1/2" Long shanks
- 1/2" IPS Thread

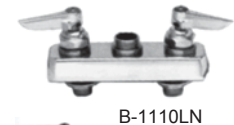

Part #	Mfg #	Description	Price
14733	B-1110-LN	4"cc less Nozzle	110.79
14745	B-1120-LN	8"cc less Nozzle	131.63



## Commercial Kitchen Faucets

### 2-Handle Splash-Back Mount Work Board Faucets



B-1115-LN



B-1125-LN

Part #	Mfg #	Description	Price
14740	B-1115-LN	4"cc less Nozzle	131.63
14751	B-1125-LN	8"cc less Nozzle	150.43

### Gooseneck Spouts



Part #	Mfg #	Height	Type	Price
14508	131X	4-3/4"	Swivel	39.18
14509	132X	8-3/4"	Swivel	41.86
14510	133X	8-3/4"	Swivel	43.61
14512	135X	11-3/4"	Swivel	54.80

### Swing Nozzles



059X - 065X



068X

Part #	Mfg #	Reach	Type	Price
14490	059X	6"	Swing	31.11
14491	060X	8"	Swing	33.34
14492	061X	10"	Swing	35.48
14493	062X	12"	Swing	37.82
14494	063X	14"	Swing	40.05
14495	064X	16"	Swing	42.39
14496	065X	18"	Swing	44.62
14499	068X	18"	Double Joint	78.17

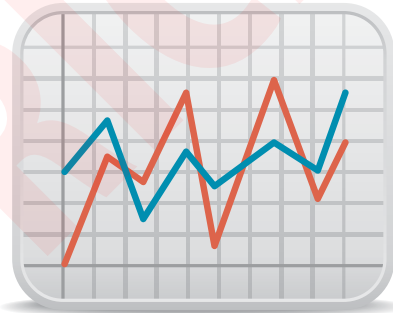

## Custom Reporting

*Need a year's worth of your purchase history? No problem! Our custom reporting capabilities allow us to get you the information you need – quickly.*



## Kitchen Faucets

Plumbing

### Single-Handle Kitchen Faucets Classic ADA Lever Handle Kitchen Faucets

- Sensible styling that complements any home
- Classically styled faucets and accessories handle the toughest of tasks with ease
- 8" long spout swings 360° for added convenience
- Single lever handle for ease of control
- Classic design perfect for single-hole sinks
- Solid brass construction ensures quality and reliability



Part #	Mfg #	Description	Holes	Finish	Price
202330	100WF	8" CC ADA Lever Handle	3	Chrome	87.33
922729	101DST	Single Hole ADA Lever	1	Chrome	87.39

### Classic ADA Lever Handle Kitchen Faucets with Integral Spray

- Sensible styling that complements any home
- Classically styled faucets and accessories handle the toughest of tasks with ease
- 9-1/2" long, 8-3/8" high spout
- 5-5/8" from deck to aerator
- Standard spout swivels 360 degrees



Part #	Mfg #	Description	Holes	Finish	Price
930820	B3310LF	8" CC ADA Lever Handle, Spray/Escutcheon	3	Chrome	94.81

### Classic ADA Lever Handle Kitchen Faucets with Side Spray

- Sensible styling that complements any home
- Classically styled faucets and accessories handle the toughest of tasks with ease
- 8" long spout swings 360° for added convenience
- Single lever handle for ease of control
- White vegetable sprayer mounts on left or right for design flexibility
- Solid brass construction ensures quality and reliability



Part #	Mfg #	Description	Holes	Finish	Price
922724	175DST	8" CC ADA Lever Handle, Spray	2	Chrome	110.06
221864	400WF	6" or 8" CC ADA Lever Handle, Black Spray	4	Chrome	109.96

## Repair Parts

**Faucet stems, replacement handles, nuts & bolts - we have it all! Our parts counter is one of the largest in Boston!**



## Kitchen Faucets



### Waterfall® Series ADA Lever Kitchen Faucets

- The High-arc design of Pilar™ provides graceful functionality
- Sleek design coupled with the latest valve technology
- New front trigger sprayer activation that allows users to more easily activate the sprayer
- Complete kitchen suite with a coordinated bar faucet
- Matching soap or lotion dispenser available
- Features a stop that allows the spout to swing only 180 degrees allowing ample flexibility to move out of the way while preventing interference with the back splash



Part #	Mfg #	Description	Holes	Finish	Price
933489	4380DST	Widespread ADA Lever, Ftgs, Spray	3	Chrome	242.95

### Two-Handle Kitchen Faucets Basic Two-Handle Kitchen Faucets

- 9" Long spout swings 360°
- Standard with 1/2" IPS shanks
- Clear knob handles have red/blue handle indicators
- Spray mounts left or right
- 2.2 gpm @ 60 psi
- Polished brass is a Brilliance® lifetime finish



Part #	Mfg #	Description	Holes	Finish	Price
12428	2100	8" CC ADA Blade Handles	3	Chrome	65.05
12437	2400	8" CC ADA Blade Handles, Spray	4	Chrome	83.10
12438	2402	8" CC Clear Knob Handles, Spray	4	Chrome	83.10

### Waterfall® Series Two-Handle Kitchen Faucets

- 9-1/2" Long 11-1/4" High spout swings 360°
- Matching vegetable spray mounts left or right
- Clear knob handles have red/blue indicators
- Standard with 1/2" IPS shanks
- 2.0 gpm @ 60 psi
- Polished brass is a Brilliance® lifetime finish



Part #	Mfg #	Description	Holes	Finish	Price
926174	2176	8" CC Metal Knob Handles	3	Chrome	147.61
193678	2476	8" CC Metal Knob Handles, Spray	3	Chrome	158.41



## Kitchen Faucets

**ELKAY**

Plumbing

### One-Handle Kitchen Faucets

#### 1-Handle Kitchen Faucets

- Deck Mounted
- Chrome
- Lever Handle
- Integral Spout
- Overall Height: 7 1/2"
- Deck Clearance: 5"
- Spout Reach: 8"
- Holes Drilling(s): 1
- Brass Construction
- Ceramic Disc Valve
- 3/8" Compression Hose Assembly
- Flow Rate: 1.5 gpm
- Code Compliance: ADA, CSA
- Previously known as model(s): LKE-4100, LKE-4101



LK1000CR



LK1001CR

Part #	Mfg #	Description	Finish	Price
948352	LK1000CR	8"cc ADA Lever, 8" Spout Reach, less Spray		77.80
948356	LK1001CR	8"cc ADA Lever, 8" Spout Reach, with Spray		94.42

### Two-Handle Kitchen Faucets

#### Hi-Arc® 2-Handle Contemporary Style Kitchen Faucets

- 1/2" IP Shanks
- Hi-arc contemporary style swing spout and deck-mounted escutcheon
- Removable Diacore flow control cartridge
- Maximum flow rate: 2.5 gpm @ 80 psig



LK-2433

Part #	Mfg #	Description	Finish	Price
38570	LK-2432	8"cc ADA Wing Levers, 8" Spout Reach, less Spray	Chrome	323.16
36475	LK-2433	8"cc ADA Wing Levers, 8" Spout Reach, with Spray	Chrome	299.22

### Hospitality/Bar Faucets

#### 2-Handle Hospitality Faucets

- Requires single faucet hole for hot & cold
- Brass base and brass forged handles
- Removable valve cartridges
- 3/8" OD Copper inlet tubes
- Maximum flow rate: 2.5 gpm @ 80 psig



Part #	Mfg #	Description	Finish	Price
12537	LKD-2223	ADA Wing Levers, Gooseneck Swing Spout with 5-5/8" Reach	Chrome	424.90

Prices & specifications are subject to change.



## Kitchen Faucets

GERBER.

### Two-Handle Kitchen Faucets

- Limited lifetime warranty on Gerber PVD finishes
- 10-Year limited warranty on Compression/Washerless Cartridges
- Limited lifetime warranty on Ceramic Disc Cartridges
- 2-Year limited warranty on other parts

#### 2-Handle Kitchen Faucets - Cast Brass Spout & Body

- 8" Tube spout
- 2.2 gpm @ 60 psi Maximum aerator
- 1/2" NPSM Supply connections with brass coupling nuts



Part #	Mfg #	Description	Finish	Price
12759	42-116	8"cc ADA Metal Handles, Compression Stems, Less Spray	Chrome	82.58
12760	42-216	8"cc ADA Metal Handles, Compression Stems, Black Spray	Chrome	112.15

### Bar Faucets

#### Gooseneck 2-Handle Spout Bar Faucets - Cast Brass Underbody

- 2.2 gpm @ 60 psi Maximum aerator



Part #	Mfg #	Description	Finish	Price
12765	49-251	4"cc ADA Metal Handles, Compression Stems	Chrome	65.43



### Single-Handle Kitchen Faucets

#### Concetto Dual Spray Pull-Down Kitchen Faucet

- Solid Brass Body
- GROHE SilkMove® Ceramic Cartridge
- SpeedClean® Anti-Lime System
- Locking Push Button Control -- to switch from regular flow to spray
- Stainless Steel Braided Flexible Supplies
- Quick Installation System
- Single Lever Handle
- Variable Handle Positioning
- 8 9/16" Spout Reach
- Flow Rate 2.2 gpm (8.4 l/min)



Part #	Mfg #	Description	Holes	Finish	Price
914569	32.244.000CP	Single Handle, Dual Pull-Down Spray	1	Polished Chrome	419.00

Prices & specifications are subject to change.

Our faucet parts counter is one of the largest in the Boston area with thousands of parts in stock!



## Kitchen Faucets

Plumbing

### Ladylux Plus Spray Pull-Out Kitchen Faucet

- Single-Handle Kitchen Pull-out
- GROHE RealSteel® stainless steel construction
- 360° swivel spout
- Dual spray control-switches back and forth between regular flow and spray
- SpeedClean anti-lime system
- Ceramic cartridge
- 56" extractable hose
- 9 1/8" spout reach
- Quick installation system
- Stainless steel braided flexible supplies
- Integral check valves
- Single hole installation



Part #	Mfg #	Description	Holes	Finish	Price
859388	33.759.SDO	Single Handle, Pull-Out Spray	1	Stainless Steel	622.00
167135	33.759.KDO	Single Handle, Pull-Out Spray	1	Stainless Steel/Black	622.00

THE BOLD LOOK  
OF **KOHLER**®

### Single-Handle Kitchen Faucets Coralais™ ADA Lever Kitchen Pull-Out Faucets

- Metal construction
- Washerless ceramic valves
- 10-7/16" Spout height, 9-1/2" swing reach
- 11" Spout height, 9" swing reach
- Integral vacuum breaker
- Single control stream-to-spray adjustment
- 10" Escutcheon plate for 2-hole installation



K-15160-0

Part #	Mfg #	Description	Holes	Finish	Price
208685	K-15160-CP	8"cc ADA Lever, Match Pull-Out Spray	1 or 3	Polished Chrome	195.19
208841	K-15160-0	8"cc ADA Lever, Match Pull-Out Spray	1 or 3	White	205.01

### Coralais™ ADA Lever Kitchen Faucets

- Metal construction
- Washerless ceramic valves
- 8-5/8" Spout height, 8-1/2" swing spout
- 10" Escutcheon



K-15172-CP

Part #	Mfg #	Description	Holes	Finish	Price
239123	K-15171-F-CP	8"cc ADA Lever, Flex Supply	1 or 3	Polished Chrome	91.33
234300	K-P15172-F-CP	8"cc ADA Lever, Match Spray, Flex Supply, P-Pack	4	Polished Chrome	133.50
233597	K-15172-F-CP	8"cc ADA Lever, Match Spray, Flex Supply	4	Polished Chrome	114.93

Prices & specifications are subject to change.





## Kitchen Faucets

### Two-Handle Kitchen Faucets Coralís® 2-Handle Kitchen Faucets

- 7-5/8" swing spout
- Blade lever handles are ADA-compliant
- One-piece ceramic valve resists debris and hard water buildup
- Ergonomic handle rotation provides on/off water control with only a quarter turn



Plumbing

Part #	Mfg #	Description	Holes	Finish	Price
79015	K-15251-B-CP	8"cc ADA Blades	3	Polished Chrome	68.61

### Triton™ 2-Handle Kitchen Base - Less Handles

- Solid brass construction
- Washerless ceramic valves
- 6-1/2" Spout height, 8-1/8" swing reach
- Includes escutcheon plate and aerator



K-7825-CP

Part #	Mfg #	Description	Holes	Finish	Price
89791	K-7825-K-CP	8"cc Less Handles	3	Polished Chrome	170.93

### Handles for Triton™ Faucets



K-16012-2



K-16012-3



K-16012-4



K-16012-5

Part #	Mfg #	Description	Price
110889	K-16012-2	Triton™ standard handles, Chrome	81.51
56166	K-16012-3	Triton™ cross handles, Chrome	81.51
92642	K-16012-4	Triton™ lever handles, Chrome	81.05
108107	K-16012-5	Triton™ wrist blade lever handles, Chrome	104.70



### Hot Water Dispenser/Tank Combos F-201 Filtration System Stainless Steel Tank & Filtration System

- Provides 60 cups/hour of near-boiling water
- For instant hot water faucets except Model Hot1
- 35% More near-boiling water from larger 2/3 gallon stainless steel tank
- Easy to adjust temperature control
- Tool-free tank connections and dry start protection to ease installation
- 115V, 750 Watts, 6.25 amps
- NSF® & UL Listed
- 3-Year We Come To You™ in-home service warranty



Part #	Mfg #	Model	Description	Price
864852	SST-FLTR	SST-FLTR	For Instant Hot Water Dispenser	312.45

Prices & specifications are subject to change.

Our office hours are 7am to 4:30pm and counter hours 6am to 4:30pm Monday through Friday.



## Kitchen Faucets

Plumbing

### F-HC1100 Contemporary ADA Lever Hot/Cold Water Dispenser Faucet

- Dispenses 60 cups of cool-filtered drinking water or near-boiling water per hour
- For use with F-201 Filtration System & InSinkEerator's stainless steel tanks
- Instant self-closing hot valve, manual return cold valve
- Adjustable thermostat control
- Durable all brass faucet construction
- 5-Year We Come To You™ in-home service warranty



Part #	Mfg #	Model	Faucet Finish	Price
864853	F-HC1100C	F-HC1100C Less Tank	Chrome	343.95

### HOT-1 ADA Lever Hot Water Dispensers

- Dispenses 40 cups of near-boiling 190°F water per hour
- Durable all brass faucet construction
- 1/3 Gallon tank capacity
- 115V, 500W, 4.3A
- 1-Year We Come To You™ warranty



Part #	Mfg #	Model	Faucet Finish	Price
12995	41746	HOT-1	SS w/Black Handle	195.60

### H770 Twist Top Hot Water Dispensers

- Dispenses 60 cups of near-boiling water per hour
- Adjustable thermostat control
- Patented DuraTank™ hot water tank system
- 2/3 Gallon stainless steel tank
- 120V, 750W, 6.25A
- 3-Year We Come to You™ warranty



Part #	Mfg #	Model	Faucet Finish	Price
867358	H770-SS	H770-SS	Chrome/Black	281.40

### H-778™ Commercial Twist Handle Hot Water Dispenser

- 2/3 Gallon stainless steel tank
- Instant, self-closing valve
- Food service grade heating element provides up to 100 cups of 190°F water per hour
- Chrome-plated faucet completely insulated from 200°F water
- Elevated spout provides access for large vessels
- Easy to adjust temperature control
- Mounts in standard sink opening or 1-1/4" drilled hole
- 120V, 1300W, 10.8A
- 1-Year full warranty on parts & labor



Part #	Mfg #	Model	Faucet Finish	Price
12994	H778	H-778	Chrome/Black	499.80

Prices & specifications are subject to change.



# Lavatory Faucets



## Bar Faucets

### 1-Handle Deck-Mount Lavatory Faucet with GN2A Rigid/Swing Spout

- Single water inlet
- Solid brass body construction
- 1/2" NPSM Coupling nut for 3/8" or 1/2" flexible risers
- Mounting hardware included



Part #	Mfg #	Description	Cartridge	Aerator	Finish	Price
12107	350-CP	1-Hole, 369 Metal ADA Lever Cold Indexed	Quatum™	E3	CP	129.94

## Single-Hole Basin Faucets

### 1-Handle Deck-Mount Lavatory Basin Faucets with 3-3/8" Integral Spout

- Solid brass body construction
- 1/2" NPSM Coupling nut for 3/8" or 1/2" flexible risers
- Mounting hardware included



Part #	Mfg #	Description	Cartridge	Aerator	Finish	Price
108783	700-COLDCP	1-Hole, 633 Metal Cross Cold Indexed Handle	Quatum™	E12	CP	92.72
108788	700-HOTCP	1-Hole, 633 Metal Cross Hot Indexed Handle	Quatum™	E12	CP	92.72

## Single Hole Lavatory Faucets

### Marathon™ 1-Handle Deck-Mount Lavatory Faucets with 4-3/4" Cast Brass Spout

- Solid brass body construction
- 3/8" OD Copper supply tube inlets
- Temperature limit stop
- Mounting hardware included
- Volume control



Part #	Mfg #	Description	Cartridge	Aerator	Finish	Price
155749	2200-CP	1-Hole, Metal ADA Lever	Ceramic Mixing	E12	CP	238.26
141566	2201-4CP	1-Hole, Metal ADA Lever, Pop-Up, Escutcheon	Ceramic Mixing	E12	CP	325.36



### Grohe Eurusmart Single-Hole Centerset Lavatory Faucet

- GROHE SilkMove® Ceramic Cartridge
- Single Lever Handle
- Stainless Steel Braided Flexible Supplies
- Model 32.643 Less Drain, 32.642 With Drain
- 1.5gpm (5.7 l/min)



Part #	Mfg #	Description	Cartridge	Finish	Price
915878	32.643.001	1-Hole less Pop-Up	Ceramic	Starlight Chrome	121.41
900558	32.642.001	1-Hole with Pop-Up	Ceramic	Starlight Chrome	137.17

Prices & specifications are subject to change.

You can check stock availability, pricing and place orders online at [www.MetPipe.com](http://www.MetPipe.com).



## Lavatory Faucets

### Grohe Concetto Single-Hole Centerset Lavatory Faucet

- GROHE SilkMove® Ceramic Cartridge
- Single Lever Handle
- Stainless Steel Braided Flexible Supplies
- Quick Installation System
- 2.2 gpm (8.4 l/min)



Part #	Mfg #	Description	Cartridge	Finish	Price
902571	34.270.000	1-Hole with Pop-Up	Ceramic	Chrome	153.73

### Grohe Concetto Single-Hole Single Lever Centerset Swivel Spout Lavatory Faucet

- 6" Swivel Spout
- Solid Brass Construction
- GROHE SilkMove® Ceramic Cartridge
- Stainless Steel Braided Flexible Supplies
- Quick Installation System
- Flow Rate 1.5gpm (5.7 l/min)



Part #	Mfg #	Description	Cartridge	Finish	Price
919965	32.138.000	1-Hole with Pop-Up	Ceramic	Starlight Chrome	212.07



### 1-Handle Single Basin Faucets

#### 1-Handle Single Basin Faucets

- Cast Brass Single Basin Faucet
- 1/2 - 14 NPS Male Shank x 2-1/4-Inches Long
- 4-Arm Cross Handle
- Replaceable Seats
- PVD Polished Chrome



Part #	Mfg #	Description	Price
12079	0239-H	Hot Cross Handle, CP	40.21
12078	0239-C	Cold Cross Handle, CP	40.21



Low flow aerators, showerheads, low GPF toilets and flushometers, and more - ALL IN STOCK.

Visit our GREEN website:

<http://green.metpipe.com>



## Lavatory Faucets

### 4in Centerset 1-Handle Lavatory Faucets

#### 4CC 1-Handle Deck Mounted Lavatory Faucet

- Marathon™ Lavatory Sink Faucet
- 4-3/4" C-C Integral Cast Brass Spout
- E12 - 2.2 GPM (8.3 L/min) Pressure Compensating Softflo® Aerator
- 2-3/4" Metal Lever Handle with Color Coded Temperature Indicator on Cap
- Ceramic Disc Operating Cartridge with Temperature Limit Stop
- 3/8" O.D. Copper Supply Tube Inlets
- 4" C-C Deck Cover Plate



Part #	Mfg #	Description	Aerator	Finish	Price
166368	2200-4CP	4"cc, Single Handle	E12	CP	267.29
155745	2201-4CP	4"cc, Single Handle, with Drain	E12	CP	296.32

#### 4CC 1-Handle Deck Mounted Lavatory Faucet

- 4-5/8" C-C Integral Cast Brass Spout
- E37 - 1.5 GPM (5.7 L/min) Pressure Compensating Laminar Flow Outlet
- 4-1/4" Metal Lever Handle with Red and Blue Service Button
- Ceramic Disc Operating Cartridge with Temperature Limit Stop
- 1/2" NPSM Supply Inlets with Coupling Nut for 3/8" or 1/2" Flexible Riser



Part #	Mfg #	Description	Aerator	Finish	Price
921928	420-CP	4"cc, Single Handle	E37	CP	101.39
954157	420-POCP	4"cc, Single Handle, with Popup	E37	CP	Call



### 4CC Classic Series ADA Lever Handle Faucets

- 4-1/4" Long spout
- Polished brass is Brilliance® lifetime finish



Part #	Mfg #	Description	Holes	Includes:	Finish	Price
923034	500-DST	4" CC ADA Lever	2	Lift Rod Hole	Chrome	91.18
921513	501-DST	4" CC ADA Lever	2	No Lift Rod Hole	Chrome	91.18
930824	B510LF	4" CC ADA Lever	3	Metal Pop-Up Drain	Chrome	91.08

Prices & specifications are subject to change.

We offer a variety of GREEN products such as flush valves, faucets, showerheads & more!



## Lavatory Faucets



### 4CC Classic Series Clear Knob Handle Faucets

- 4-1/2" Long spout
- Polished brass is Brilliance® lifetime finish



Part #	Mfg #	Description	Holes	Includes:	Finish	Price
930845	B512LF	4" CC Clear Knob	3	Metal Pop-Up Drain	Chrome	86.57

Plumbing

THE BOLD LOOK  
OF **KOHLER**®

### Coralais™ 1-Handle Lavatory Faucets

- 4-1/4" Spout reach
- Solid brass construction
- Pop-up drain, 1-1/4" tailpiece & flexible supplies



Part #	Mfg #	Description	Holes	Finish	Price
223955	K-15182-F-CP	4"cc ADA 3-1/4" Lever, Aerator	3	Polished Chrome	111.96

### Coralais™ Commercial Single ADA Lever

- 4-1/2" Spout reach
- Flexible supplies
- Aerator



Part #	Mfg #	Description	Holes	Finish	Price
231659	K-15199-F-CP	4"cc ADA 3-1/4" Lever, Less Drain & Lift Rod Hole	3	Polished Chrome	95.21



### 4in Centerset 2-Handle Lavatory Faucets

#### 2-Handle Deck-Mount Sink Faucet with GN1A Rigid/Swing Gooseneck Spout

- Solid brass body construction
- 1/2" NPSM Supply inlets with coupling nuts for 3/8" or 1/2" flexible risers
- Mounting hardware included
- Handles indexed hot & cold



Part #	Mfg #	Description	Cartridge	Aerator	Finish	Price
12143	894-317CP	4"cc, 317 Metal ADA Wrist Blade Handles, Pop-Up	Quatum™	E3	CP	246.95

Prices & specifications are subject to change.



## Lavatory Faucets

### 2-Handle Deck-Mount Sink Faucet with GN1A Rigid/Swing Gooseneck Spout

- Solid brass body construction
- 1/2" NPSM Supply inlets with coupling nuts for 3/8" or 1/2" flexible risers
- Mounting hardware included
- Handles indexed hot & cold



Part #	Mfg #	Description	Cartridge	Aerator	Finish	Price
12144	895-CP	4"cc, 317 Metal ADA Wrist Blade Handles, 3-1/2" Spout	Quaturn™	E3	CP	155.48
12145	895-317CP	4"cc, 317 Metal ADA Wrist Blade Handles, 3-1/2" Spout	Quaturn™	E3	CP	167.77
169940	895-317FCCP	4"cc, 317 Metal ADA Wrist Blade Handles, 3-1/2" Plain Spout	Quaturn™	E3	CP	185.09
166816	895-317GN2FCCP	4"cc, 317 Metal ADA Wrist Blade Handles, 5-1/4" Plain Spout	Quaturn™	E3	CP	187.41

### 2-Handle Deck-Mount Faucet with 4" Integral Spout and Pop-Up

- Solid brass body construction
- 1/2" NPSM Supply inlets with coupling nuts for 3/8" or 1/2" flexible risers
- Mounting hardware included
- Handles indexed hot & cold



Part #	Mfg #	Description	Cartridge	Aerator	Finish	Price
222675	797-VCP	4"cc, 390 Metal Curved ADA Levers	Quaturn™	E12VP	CP	194.52
225261	797-V317CP	4"cc, 317 Metal Wrist blade ADA Levers	Quaturn™	E12VP	CP	206.36
222984	797-V1000CP	4"cc, 1000 Metal Wing Canopy ADA Levers	Quaturn™	E12VP	CP	176.45

### 2-Handle Deck-Mount Faucet with 4" Integral Spout

- Solid brass body construction
- 1/2" NPSM Supply inlets with coupling nuts for 3/8" or 1/2" flexible risers
- Mounting hardware included
- Handles indexed hot & cold



Part #	Mfg #	Description	Cartridge	Aerator	Finish	Price
221672	802-VCP	4"cc, 390 Metal Curved ADA Levers	Quaturn™	E12VP	CP	129.34
221669	802-V317CP	4"cc, 317 Metal Wrist blade ADA Levers	Quaturn™	E12VP	CP	144.85
221597	802-V1000CP	4"cc, 1000 Metal Wing Canopy ADA Levers	Quaturn™	E12VP	CP	130.50

Prices & specifications are subject to change.

Our state of the art pipe shop offers cutting, threading, grooving and make-ons up to 36in!



## Lavatory Faucets

### Classic Style Two-Handle 4" CC Lavatory Faucets

- 3-7/16" Long spout
- Polished Brass is Brilliance® lifetime finish



2500



2502



2520



2522



2529-LGHDF

Part #	Mfg #	Description	Holes	Includes:	Finish	Price
12444	2500	ADA Blades *	2 or 3	Capped Lift Rod Hole	Chrome	58.58
12445	2502	Clear Knobs *	2 or 3	Capped Lift Rod Hole	Chrome	58.58
12447	2520MPU	ADA Blades	3	Metal Pop-Up Drain	Chrome	83.18
12450	2522MPU	Clear Knobs	3	Metal Pop-Up Drain	Chrome	83.27
12454	2529-LGHDF	Wrist Blades*	2	Capped Lift Rod Hole	Chrome	107.26

\* Notched undercover plate to accept RP7584 chain & stopper

## GERBER.

### Two-Handle Lavatory Faucets

- Limited lifetime warranty on Gerber PVD finishes
- 10-Year limited warranty on Compression/Washerless Cartridges
- Limited lifetime warranty on Ceramic Disc Cartridges
- 2-Year limited warranty on other parts

#### 2-Handle Lavatory Faucet - Solid Brass Casting

- 5-1/8" Spout reach
- 2.2 gpm @ 60 psi Maximum aerator



Part #	Mfg #	Description	Finish	Price
12762	43-431	4" CC ADA Metal Handles, Washerless, Metal Pop-Up	Chrome	86.61

## THE BOLD LOOK OF KOHLER®

### Revival™ 2-Handle Lavatory Faucets

- 5-1/4" Spout reach
- Solid brass construction
- Pop-up drain, 1-1/4" tailpiece
- Aerator



K-16102-4A-CP

Part #	Mfg #	Description	Finish	Price
56793	K-16101-4A-CP	4"cc ADA Traditional Levers	Polished Chrome	265.63





## Lavatory Faucets

### Coralais® 2-Handle Centerset Lavatory Faucets

- Metal construction
- Lift rod hole with plug
- For 4" (10.2 cm) centers
- 4-1/4" (10.8 cm) spout reach
- Pop-up drain with lift rod and tailpiece
- Stationary spout
- Available with sculpted acrylic handles [-7] or ADA compliant lever handles [-4]
- Complements the Coralais Suite
- 1.5 gallons (5.7 liters) per minute maximum flow rate



Part #	Mfg #	Description	Finish	Price
886396	K-15241-7-CP	4"cc with sculpted acrylic handles (Replaced: K-11800-U-CP)	Polished Chrome	83.11

### Trend® 2-Handle Lavatory Faucets

- 3-5/8" Spout reach
- Triple plated chrome finish
- Pop-up drain, 1-1/4" tailpiece
- Aerator



Part #	Mfg #	Description	Finish	Price
13812	K-11800-U-CP	4"cc Metal Knobs	Polished Chrome	99.00
13814	K-11802-U-CP	4"cc Metal Knobs, Lift Rod Hole with Plug	Polished Chrome	80.00

### Triton™ 4" Centerset Commercial 2-Handle Lavatory Faucets

- 4" Spout reach
- Pop-up drain, 1-1/4" tailpiece
- Vandal resistant screws, aerator & color-coded index caps
- Requires K-16010 handles (not included).



Part #	Mfg #	Description	Finish	Price
89488	K-7401-K-CP	4"cc Less Handles	Polished Chrome	105.79
89503	K-7404-K-CP	4"cc Less Handles, Less Drain & Lift Rod	Polished Chrome	72.72

### Triton™ Commercial 2-Handle Lavatory Faucets with Gooseneck Spout

- 5-1/4" Gooseneck spout
- Brass construction
- 1/4-Turn washerless ceramic disc valves
- Aerator
- Flexible connections unless stated
- Requires K-16010 handles (not included).



Part #	Mfg #	Description	Finish	Price
56167	K-7305-K-CP	4"cc Less Handles, Less Drain & Lift Rod	Polished Chrome	79.28



## Lavatory Faucets

### Handles for 2-Handle Commercial Lavatory Faucets



K-16012-2



K-16012-3



K-16012-4



K-16012-5

Part #	Mfg #	Description	Price
110889	K-16012-2	Triton™ standard handles, Chrome	81.51
56166	K-16012-3	Triton™ cross handles, Chrome	81.51
92642	K-16012-4	Triton™ lever handles, Chrome	81.05
108107	K-16012-5	Triton™ wrist blade lever handles, Chrome	104.70



### 8in Centerset 2-Handle Lavatory Faucets

#### 2-Handle Concealed Hot and Cold Water Sink Faucet

- Deck Mounted Fully Adjustable, 6" - 26" Concealed Hot and Cold Water Sink Faucet
- Polished chrome plated solid brass construction.
- 5" Center to Center Rigid Cast Brass Spout.
- 2.2 GPM (8.3 L/min) Pressure
- Compensating Softflo Aerator.
- Sixteen Point Tapered Broach and Secured Blue and Red Buttons.
- Quatern™ rebuildable compression cartridge, opens and closes 90°, closes with water pressure, features square tapered stem.
- Flexible stainless steel hoses allow handle placement from 6" - 26".
- 1/2" NPSM Supply Inlets and Coupling Nut for 3/8" or
- 1/2" Flexible Riser.
- Mounting hardware included.



404-HZ317CP



404-HZCP

Part #	Mfg #	Description	Cartridge	Aerator	Finish	Price
219886	404-HZCP	8"cc, 390 Metal Curved ADA Levers	Quatern™	E12VP	CP	242.17
219888	404-V317CP	8"cc, 317 Metal ADA Wrist Blade Handle	Quatern™	E12VP	CP	245.97

#### 2-Handle Deck-Mount Lavatory Faucet with 3-1/2" Spout & Pop-up

- Lavatory Sink Faucet with Pop-up Waste
- GN1A - 3-1/2" C-C Rigid/Swing Gooseneck Spout
- E3 - 2.2 GPM (8.3 L/min) Pressure Compensating Softflo® Aerator
- 317 - 4" Metal Wrist blade Handles with Secured Red and Blue Service Buttons
- Quatern™ Operating Cartridges
- 1/2" NPSM Supply Inlets with Coupling Nut for 3/8" or 1/2" Flexible Riser



Part #	Mfg #	Description	Cartridge	Aerator	Finish	Price
12127	794-317CP	8"cc, 317 Metal ADA Wrist Blade Handle	Quatern™	E3	CP	307.38

Plumbing



## Lavatory Faucets

### 2-Handle Widespread Lavatory Faucets

#### Revival™ 2-Handle Lavatory Faucets

- 5-1/4" Spout reach
- Solid brass construction
- Pop-up drain, 1-1/4" tailpiece
- Aerator



Part #	Mfg #	Description	Finish	Price
35979	K-16102-4-PB	8" - 16"ws ADA Scroll Levers	Polished Brass	656.95
79374	K-16102-4A-CP	8" - 16"ws ADA Traditional Levers	Polished Chrome	370.97
79376	K-16102-4A-PB	8" - 16"ws ADA Traditional Levers	Polished Brass	656.95

### Coralais® Widespread 2-Handle Lavatory Faucets

- Metal construction
- Lift rod hole with plug
- For 4" (10.2 cm) centers
- 4-1/4" (10.8 cm) spout reach
- Pop-up drain with lift rod and tailpiece
- Stationary spout
- Available with sculpted acrylic handles [-7] or ADA compliant lever handles [-4]
- Complements the Coralais Suite
- 1.5 gallons (5.7 liters) per minute maximum flow rate



Part #	Mfg #	Description	Finish	Price
223100	K-15261-4-CP	8" - 12"ws, ADA lever handles, 4-1/4" spout	Polished Chrome	182.69

### Triton® Widespread Lavatory Base Faucet

- 5-1/4" Gooseneck spout
- Brass valve bodies & brass construction
- 1/4-Turn washerless ceramic disc valves
- 12" Rigid connections
- Requires K-16010 handles (not included).



Part #	Mfg #	Description	Finish	Price
89461	K-7313-K-CP	12"cc Less Handles & Drain	Polished Chrome	126.95

### Triton™ Widespread Commercial 2-Handle Lavatory Faucets

- 5" Spout reach
- Pop-up drain, 1-1/4" tailpiece & flexible connections
- Vandal resistant screws, aerator & color-coded index caps
- Requires K-16010 handles (not included).



Part #	Mfg #	Description	Finish	Price
89553	K-7437-K-CP	8" - 16"ws Less Handles	Polished Chrome	136.46
56165	K-7443-K-CP	8" - 16"ws Less Handles, Less Drain & Lift Rod	Polished Chrome	89.84



## Lavatory Faucets

### Handles for 2-Handle Commercial Lavatory Faucets



K-16012-2



K-16012-3



K-16012-4



K-16012-5

Part #	Mfg #	Description	Price
110889	K-16012-2	Triton™ standard handles, Chrome	81.51
56166	K-16012-3	Triton™ cross handles, Chrome	81.51
92642	K-16012-4	Triton™ lever handles, Chrome	81.05
108107	K-16012-5	Triton™ wrist blade lever handles, Chrome	104.70



### 2-Handle Widespread Lavatory Faucets

#### Geneva Low Spout Lavatory Wideset Faucet

- Cast brass spout
- GROHE SilkMove® ceramic cartridges
- Pop-up drain
- Sold less handles
- Flow Rate 1.5gpm (5.7 l/min)



Part #	Mfg #	Description	Holes	Finish	Price
207659	20.801.000	Less handles, with pop-up	3	Starlight Chrome	421.76

#### Somerset Lavatory Wideset Faucet

- GROHE SilkMove® Ceramic Cartridges
- Less handles
- Flow Rate 1.5gpm (5.7 l/min)



Part #	Mfg #	Description	Holes	Finish	Price
890264	20.133.000	Less handles, less pop-up	3	Starlight Chrome	330.32

### Grohe Lavatory Handles



Geneva 18733



Geneva 18734



Somerset 18172

Part #	Mfg #	Description	Price
229051	18.733.000	Geneva Collection Cross Handles (Pair)	121.41
207660	18.734.000	Geneva Collection Lever Handles (Pair)	121.41
890266	18.172.000	Somerset Collection Lever Handles (Pair)	120.62



# Metering Lavatory Faucets

## Metering Lavatory Faucets

### 1-Handle Deck-Mount Metering Lavatory Faucet with 3-3/8" Spout

- Lavatory Metering Faucet
- 3-3/8" C-C Integral Cast Spout
- E12 - 2.2 GPM (8.3 L/min) Pressure Compensating Softflo® Aerator
- 1/2" NPSM Supply Inlets with Coupling Nut for 3/8" or 1/2" Flexible Riser



333-665PSH 333-336PSH

Part #	Mfg #	Description	Cartridge	Aerator	Finish	Price
232504	333-336PSHCP	1-Hole, 336 Push Tilt Handle	Naiad	E12	CP	149.15
201070	333-665PSHCP	1-Hole, 665 MVP™ ADA Push Button Handle	MVP™	E12	CP	114.55

### 1-Handle Deck-Mount Metering Lavatory Faucet with 4-1/8" Integral Spout

- Solid brass body construction
- 1/2" NPSM Coupling nut for 3/8" or 1/2" flexible risers
- Mounting hardware included



Part #	Mfg #	Description	Cartridge	Aerator	Finish	Price
109127	807-665PSHCP	1-Hole, 665 MVP™ ADA Push Button Handle	MVP™	E15	CP	82.62
241679	807-E12665PSHCP	1-Hole, 665 MVP™ ADA Push Button Handle	MVP™	E12	CP	130.52

### 1-Handle Deck-Mount Metering Lavatory Faucet with 4-1/8" Integral Spout

- Lavatory Metering Sink Faucet
- 4-1/8" C-C Integral Cast Brass Spout
- E15 - 2.0 GPM (7.6 L/min) Rose Spray Outlet
- 665 - 1-3/4" Round MVP™ Metering Handle with Hot and Cold Index Buttons
- MVP™ Metering Adjustable Self Closing Cartridge
- 1/2" NPSM Supply Inlets with Coupling Nut for 3/8" or 1/2" Flexible Riser
- 4" C-C Deck Cover Plate



Part #	Mfg #	Description	Cartridge	Aerator	Finish	Price
184405	857-665PSHCP	1-Hole, 665 MVP™ ADA Push Button Handle	MVP™	E15	CP	199.56

### 2-Handle Deck-Mount Metering Lavatory Faucet with 4" Integral Spout

- Solid brass body construction
- 1/2" NPSM Supply inlets with coupling nuts for 3/8" or 1/2" flexible risers
- Mounting hardware included



Part #	Mfg #	Description	Cartridge	Aerator	Finish	Price
12131	802-V665CP	4"cc, 665 MVP™ ADA Push Button Handles	MVP™	E12VP	CP	214.83

Prices & specifications are subject to change.

Our faucet parts counter is one of the largest in the Boston area with thousands of parts in stock!



## Metering Lavatory Faucets

### 1-Handle Deck-Mount Metering Lavatory Faucet with 4-3/4" Integral Spout

- MeterMix® Lavatory Metering Faucet
- 4-3/4" C-C Integral Cast Brass Spout
- E2805 - Vandal Proof 0.5 GPM (1.9 L/min) Econo-Flo Pressure Compensating Spray Outlet
- Metal Handle with Concealed Vandal Resistant Screw
- MVP™ Metering Adjustable Self Closing Cartridge
- 1/2" NPSM Supply Inlets with Coupling Nut for 3/8" or 1/2" Flexible Riser
  - TCP with Single Supply Line with Inlet Tee Connection with 1/4" NPT Check Stop Tailpieces



Part #	Mfg #	Description	Cartridge	Aerator	Finish	Price
806604	3300-CP	4"CC, MVP™ Metal Handle	MVP™	E2805	CP	263.82
866648	3400-CP	4"CC, MVP™ Metal Handle	MVP™	E2805	CP	159.38
866650	3400-TCP	4"CC, MVP™ Metal Handle, Single Supply Inlet	MVP™	E2805	CP	201.38

### 2-Handle 8CC Deck-Mount Metering Lavatory Faucet with 5" Spout

- Concealed Lavatory Metering Sink Faucet
- 5" C-C Rigid Cast Brass Spout
- E12VP - Vandal Proof 2.2 GPM (8.3 L/min) Pressure Compensating Softflo® Aerator
- 665 - 1-3/4" Round MVP™ Metering Handles with Hot and Cold Index Buttons
- MVP™ Metering Adjustable Self Closing Cartridges
- 1/2" NPSM Supply Inlets with Coupling Nut for 3/8" or 1/2" Flexible Riser



Part #	Mfg #	Description	Cartridge	Aerator	Finish	Price
224607	404-V665CP	8"CC, MVP 665 Metal Handles	MVP™	E12VP	CP	271.59

### 2-Handle 8CC Concealed Lavatory Metering Sink Faucet

- Concealed Lavatory Metering Sink Faucet
- GN2A - 5-1/4" C-C Rigid/Swing Gooseneck Spout
- E3 - 2.2 GPM (8.3 L/min) Pressure Compensating Softflo® Aerator
- 665 - 1-3/4" Round MVP™ Metering Handles with Hot and Cold Index Buttons
- MVP™ Metering Adjustable Self Closing Cartridges
- 1/2" NPSM Supply Inlets with Coupling Nut for 3/8" or 1/2" Flexible Riser



Part #	Mfg #	Description	Cartridge	Aerator	Finish	Price
220358	786-E3665CP	8"CC, MVP™ 665 Metal Handles	MVP™	E3	CP	253.72

## Repair Parts

Faucet stems, replacement handles, nuts & bolts - we have it all! Our parts counter is one of the largest in Boston!



## Metering Lavatory Faucets

### Metering Lavatory Faucets

#### 1-Handle Deck-Mount Metering Lavatory Faucet

- Metering/Temperature Selection Faucet with blade type handle for handicap accessible applications.
- Solid brass 4" center set slow-closing lavatory faucet to meter and mix hot and cold water supply.
- Temperature limit stop to adjust outlet temperature. Time limit stop to adjust flow time.
- Spray outlet with 0.5 gpm flow rate.
- Vandal resistant.



Plumbing

Part #	Mfg #	Description	Cartridge	Aerator	Finish	Price
14440	S-60-H	1-Hole, Blade Handle	-	0.5 GPM	CP	219.63



### 2-Handle Metering Lavatory Faucets

#### 2-Handle 4CC Metering Slow-Closing Lavatory Faucet

- Synergy® 4" Centerset metering lavatory faucet
- Vandal resistant tip action lever handles
- Cast brass body
- Slow-close
- No lift rod hole
- Vandal resistant non-aerating spray outlet
- Limited Faucet and Finish Warranty



Part #	Mfg #	Description	Holes	Includes:	Finish	Price
180142	86T1153	Tip action lever handles	2	No Lift Rod Hole	Chrome	194.07



### Self-Closing Metering Faucets

#### 1-Hole Self-Closing Metering Faucets

- Constructed of solid brass for durability and reliability
- Solid brass construction for durability and reliability
- Self-closing faucet



Part #	Mfg #	Description	Holes	Finish	Price
13635	K-7504-C	Cold- Self-closing faucet	1	Polished Chrome	160.89
13634	K-7504-H	Hot- Self-closing faucet	1	Polished Chrome	160.89
13633	K-7500-C	Cold- Self-closing faucet	1	Polished Chrome	106.85
13632	K-7500-H	Hot- Self-closing faucet	1	Polished Chrome	106.85

Prices & specifications are subject to change.

Our office hours are 7am to 4:30pm and counter hours 6am to 4:30pm Monday through Friday.



## Electronic Faucets

Plumbing

### Electronic Lavatory Faucets

#### Single Hole AC/Battery Powered Electronic Lavatory Faucet

- Single Hole or 4" Centers, Deck Mount, Electronic Lavatory Faucet with Dual Beam Infrared Sensor
- 5-3/8" C-C Spout
- E2805 - 0.5 GPM (1.9 L/min) Vandal Resistant Spray Outlet
- ECAST® design provides durable brass construction with total lead content equal to or less than 0.25% by weighted average
- Multiple Field Adjustable Modes and Ranges
- Geberit Commander Software Compatible



Part #	Mfg #	Mount	Type	Finish	Price
931223	116.606.AB.1	1 Hole Deck Mount	6V Lithium Battery	CP	358.66
931226	116.706.AB.1	1 Hole Deck Mount	12V Transformer (Not Included)	CP	379.76

#### Single Hole Battery Powered Electronic Lavatory Faucet

- Battery Powered, Sensor Activated, Chrome Plated Brass Pedestal Electronic Hand Washing
- Faucet for tempered or hot/cold water operation.
- Sensor Range Adjustment Screw
- Low Battery LED Indicator Light
- User friendly Variable Time Out Settings
- Filtered Solenoid Valve with serviceable Strainer Filter
- Bak-Chek® Tee for Hot/Cold Supply
- Includes four (4) AA-size Alkaline Batteries
- 0.5 gpm/1.9 Lpm Vandal Resistant Spray Head



Part #	Mfg #	Mount	Type	Finish	Price
202443	EBF615-4	1 Hole Deck Mount	(C) AA Size Batteries	CP	507.52

#### Single Hole AC/Battery Powered Electronic Lavatory Faucet

- Single Hole, Deck Mount, Traditional Electronic Lavatory Faucet with Dual Beam Infrared Sensor
- E2805 - 0.5 GPM (1.9 L/min) Vandal Resistant Spray Outlet
- Dual Supply for Hot and Cold Water Service
- Concealed Internal Temperature Control Mixer
- Stainless Steel Hoses Included
- Includes Optional 2.2 GPM (8.3 L/min) Aerator Insert
- ECAST® design provides durable brass construction with total lead content equal to or less than 0.25% by weighted average
- Multiple Field Adjustable Modes and Ranges
- Geberit Commander™ Software Compatible



Part #	Mfg #	Mount	Type	Finish	Price
882785	116.211.AB.1	1 Hole Deck Mount	6V Lithium Battery	CP	501.41
934853	116.101.AB.1	1 Hole Deck Mount	12V Transformer (Not Included)	CP	Call





## Electronic Faucets

### Single Hole Battery Powered Electronic Lavatory Faucet

- Battery Powered, Sensor Activated Electronic Hand Washing Faucet for tempered or hot/cold water operation.
- Fiber Optic, Automatic, Self-adaptive Sensing
- Isolated Latching Solenoid Operator, isolates magnetic components from water contact
- Audible Tone Low Battery Indicator
- Bak-Chek® Tee for Hot/Cold Supply
- Polypropylene Optic Cable Protection
- Includes four (4) C-size Alkaline Batteries
- 0.5 gpm/1.9 Lpm Vandal Resistant Spray Head



Plumbing

Part #	Mfg #	Mount	Type	Finish	Price
142585	EBF-85	1 Hole Deck Mount, 4in Trim Plate	(C) C Size Batteries	CP	554.22

### Single Hole Battery Powered Electronic Lavatory Faucet

- Single Hole, Deck Mount, Contemporary Electronic Lavatory Faucet with Dual Beam Infrared Sensor
- E2805 - 0.5 GPM (1.9 L/min) Vandal Resistant Spray Outlet
- Dual Supply for Hot and Cold Water Service
- User Adjustable Temperature Control Mixer
- 6 Volt Lithium CRP2 Battery (Included)
- Stainless Steel Hoses Included
- Includes Optional 2.2 GPM (8.3 L/min) Aerator Insert
- ECAST® design provides durable brass construction with total lead content equal to or less than 0.25% by weighted average
- Multiple Field Adjustable Modes and Ranges
- Geberit Commander™ Software Compatible



Part #	Mfg #	Mount	Type	Finish	Price
893935	116.222.AB.1	1 Hole Deck Mount	6V Lithium Battery	CP	634.54

### Single Hole AC/Battery Powered Electronic Lavatory Faucet

- Traditional solid brass fuses
- Touchless electronic faucet
- Tripoint technology that is more accurate than current infrared
- Mixer handle that allows the user to adjust the desired temperature
- Flexible stainless steel supplies and mounting hardware are included
- Factory set - no need to calibrate



Part #	Mfg #	Mount	Type	Finish	Price
859648	K-10950	1 Hole Deck Mount	6V Lithium Battery	CP	595.85
804417	K-10951	1 Hole Deck Mount	12V Transformer (Not Included)	CP	757.70

Prices & specifications are subject to change.

You can check stock availability, pricing and place orders online at [www.MetPipe.com](http://www.MetPipe.com).



## Electronic Faucets

### Single Hole Battery Powered Electronic Lavatory Faucet

- The KOHLER hybrid energy system is a first-of-its kind 30-year power solution for touchless faucets. When combined with Insight Technology, this system provides an environmentally-friendly, virtually maintenance-free electronic faucet.
- Insight™ adaptive infrared technology
- Waterproof shroud protects electronic components
- Water-saving vandal-resistant 0.5 gpm aerator

**KOHLER.**



Part #	Mfg #	Mount	Type	Finish	Price
926657	K-7514-CP	1 Hole Deck Mount	6V Lithium Battery	CP	392.04
934479	K-7515-CP	1 Hole Deck Mount, w/Mixer	6V Lithium Battery	CP	540.00

### Single Hole Battery AC/Powered Electronic Lavatory Faucet

- Touchless battery-powered gooseneck faucet
- Designed to be more accurate and reliable than the current standard Infrared products
- Solid brass construction combined with world-class finishes ensures years of reliable performance
- Mixer handle allows preset desired temperature

**KOHLER.**



Part #	Mfg #	Mount	Type	Finish	Price
870661	K-10952-CP	1 Hole Deck Mount	Lithium Battery	CP	859.20
875024	K-10953-CP	1 Hole Deck Mount	Transformer (Not Included)	CP	673.85

### Single Hole AC/Battery Powered Electronic Lavatory Faucet

- Single Hole, Gooseneck Wall Mount, Electronic Lavatory Faucet with Dual Beam Infrared Sensor
- E2805-5 - 0.5 GPM (1.9 L/min) Vandal Resistant Spray Outlet
- Single Supply for Tempered Water
- Stainless Steel Hose Included
- Includes Optional 2.2 GPM (8.3 L/min) Aerator Insert
- ECAST® design provides durable brass construction with total lead content less than 0.25% by weighted average
- Multiple Field Adjustable Modes and Ranges
- Geberit Commander™ Software Compatible



116.204.AB.1 116.427.AB.1

Part #	Mfg #	Mount	Type	Finish	Price
899461	116.204.AB.1	1 Hole Wall Mount	6V Lithium Battery	CP	632.03
Call	116.427.AB.1	1 Hole Deck Mount	Transformer (Not Included)	CP	Call



## Electronic Faucets

### Electronic Lavatory Faucet A/C Transformers

#### Chicago Electronic Faucet Transformers

- *Hardwired:*
  - Up to 8 faucets
  - 4" Mounting Plate
- *Plug-in:*
  - Single Use
  - Standard 2 Prong 115V Outlet
- Class 2A Transformer
- Input Voltage 120VAC 60Hz
- Output Voltage 12VAC
- Short Circuit (Thermal Cutout) Protection



Part #	Mfg #	Description	Price
911494	240.630.00.1	Plug-in transformer, single use.	38.77
882856	240.631.00.1	Hardwired transformer, up to 8 faucets	46.47



### Model 20300 Mechanical Mixing Valve

- Integral check valves on inlets
- Compression sleeves and nuts included
- Locking dial adjustment with lever
- Brass construction, chrome-plated finish



Part #	Mfg #	Inlet	Outlet	Min. Flow GPM	Max Flow GPM	Price
170662	20300	3/8"	3/8"	-	-	59.00

### Model 270 Thermostatic Point-of-Use Mixing Valve

- 1/2" wax type for single or multiple lavatories, sinks, or bathtubs.
- Bronze body with Stainless steel springs
- Locked temperature adjustment cap (vandal resistant)
- Copper encapsulated thermostat assembly with polymer thermoplastic shuttle
- Integral check valves on hot and cold inlets
- Maximum Hot Water temperature: 200°F- (93°C)



Part #	Mfg #	Inlet	Outlet	Min. Flow GPM	Max Flow GPM	Price
176878	270	1/2"	1/2"	0.5	7	119.17



## Laundry & Utility Sink Faucets

**SPEAKMAN®**

Plumbing

### Sink Faucets

#### Commander® 2-Handle Cast Brass Sink Faucet

- Perfect® valves
- Integral stops
- 1/4-Turn ceramic cartridges
- Vandal-resistant 4-arm handles with color-coded indexes
- Cast brass nozzle with 3/4" hose coupling discharge, pail hook & top brace
- 1/2" NPTF Inlets



Part #	Mfg #	Finish	Price
14353	SC-5811-RCP	Rough Chrome-Plated	117.51

THE BOLD LOOK  
OF **KOHLER®**

### Single-Handle Commercial Service Sink Faucets

#### Cannock™ ADA Lever Commercial Wash Sink Faucet with Spray

- 4" Spout reach
- 1/2" IPS Outside threaded couplings
- Valvet® valves & adjustable flanges



Part #	Mfg #	Description	Holes	Finish	Price
13706	K-8892-RP	Wall-Mount ADA Levers with Spray	1	Rough Plate	173.57

### Two-Handle Commercial Service Sink Faucets

#### Clearwater™ Commercial 2-Handle Sink Supply Faucets

- 8" Swing spout
- Valvet® valves
- Aerator
- Inside threaded couplings



Part #	Mfg #	Description	Holes	Finish	Price
13683	K-7855-4-CP	8"cc ADA Levers, Soap Dish	2	Polished Chrome	431.46

### Kinlock™ Commercial 2-Handle Service Sink Faucets

- Threaded spout with 4-5/8" reach
- Inside threaded couplings
- Valvet® valves
- Vacuum breaker
- Pail hook
- Wall-brace



Part #	Mfg #	Description	Holes	Finish	Price
13715	K-8907-CP	8"cc ADA Levers, 7-1/4" Wall to Spout	2	Polished Chrome	251.56
13714	K-8907-RP	8"cc ADA Levers, 7-1/4" Wall to Spout	2	Rough Plate	183.75

\* Loose key stops in shanks

Prices & specifications are subject to change.



## Laundry & Utility Sink Faucets

### Knoxford™ Commercial 2-Handle Service Sink Faucets

- Threaded spout with 2-1/4" reach
- Inside threaded couplings
- Valvet® valves
- Vacuum breaker
- Pail hook



K-8905



K-8906

Plumbing

Part #	Mfg #	Description	Holes	Finish	Price
13711	K-8905-CP	8"cc ADA Levers, 4-7/8" Wall to Spout	2	Polished Chrome	193.18
13710	K-8905-RP	8"cc ADA Levers, 4-7/8" Wall to Spout	2	Rough Plate	160.97
13713	K-8906-RP	8"cc ADA Levers, 6-1/4" Wall to Spout *	2	Rough Plate	197.63

\* Loose key stops in shanks

### Kohler® 2-Handle Service Sink Faucets

- 3" Spout reach
- Vacuum breaker
- Valvet® valves
- Loose key stops
- Rubber hose
- Wall-hook



Part #	Mfg #	Description	Holes	Finish	Price
13719	K-8928-CP	8"cc ADA Wrist blade Levers, 7" Wall to Spout	2	Polished Chrome	395.18



### Service Sink Faucets

#### 2-Handle Wall-Mount Service Sink Faucet - Adjustable 7-5/8" - 8-3/8" Centers

- Service Sink Faucet
- Vacuum Breaker Spout with Pail Hook and Wall Brace
- 3/4" Male Hose Thread Outlet
- 369 - 2-3/8" Metal Lever Handles with Secured Red and Blue Service Buttons
- 1/2" NPT Adjustable Female Union Nut Supply Arms
- Atmospheric Vacuum Breaker, Not Intended For Continuous Pressure Applications



Part #	Mfg #	Description	Cartridge	Aerator	Finish	Price
12147	897-CP	7-5/8" - 8-3/8" Centers, 369 Metal Lever Handles	Quatum™	-	CP	184.43
12146	897-RCF	7-5/8" - 8-3/8" Centers, 369 Metal Lever Handles	Quatum™	-	RC	145.00

#### 2-Handle Wall-Mount Service Sink Faucet with 897S Vacuum Breaker Spout with 3/4" Male Hose Thread Outlet

- Solid brass body construction
- Pail hook and wall brace
- "WXF" 1/2" FNPT Straight supply arms
- Mounting hardware included



Part #	Mfg #	Description	Cartridge	Aerator	Finish	Price
53738	540-LD897SWXFCP	8"cc, 369 Metal ADA Levers w/Hot & Cold Indexes	Quatum™	-	CP	281.69

Prices & specifications are subject to change.

Our state of the art pipe shop offers cutting, threading, grooving and make-ons up to 36in!



## Laundry & Utility Sink Faucets

### 2-Handle Wall-Mount Service Sink Faucets with S6 Cast Swing Spout

- Solid brass body construction
- "H" Adjustable 1/2" FNPT supply arms
- Mounting hardware included
- Handles indexed hot & cold



445-CP

Part #	Mfg #	Description	Cartridge	Aerator	Finish	Price
12112	445-CP	4" - 8-3/8"cc, 369 Metal ADA Levers	Quatum™	E3	CP	204.64
108623	445-LESSSPTCP	4" - 8-3/8"cc, 369 Metal ADA Levers, Less Spout	Quatum™	E3	CP	163.61

### 2-Handle Wall-Mount Service Sink Faucet with Vacuum Breaker Short Spout with Pail Hook

- Solid brass body construction
- 1/2" FNPT Supply arms
- Loose wall flange
- Handles indexed hot & cold



Part #	Mfg #	Description	Cartridge	Aerator	Finish	Price
12105	305-VBRCP	4" - 8-3/8"cc, 369 Metal ADA Levers, "R" Adj Supply Arms	Quatum™	-	CP	235.78

### 2-Handle Wall-Mount Exposed Service Sink Faucets with S6 Cast Swing Spout

- Solid brass body construction
- "G" Adjustable 1/2" FNPT supply arms
- Loose wall flange
- Handles indexed hot & cold



540-LD



540-LDLESSPT

Part #	Mfg #	Description	Cartridge	Aerator	Finish	Price
12113	540-LDCP	7-1/4" - 8-3/4"cc, 369 Metal ADA Levers	Quatum™	E3	CP	201.72
52353	540-LDLESSSPTCP	7-1/4" - 8-3/4"cc, 369 Metal ADA Levers, Less Spout	Quatum™	-	CP	156.12

### 2-Handle Wall-Mount Exposed Service Sink Faucet with Vacuum Breaker Spout with Pail Hook and Wall Brace

- Solid brass body construction
- Adjustable 1/2" FNPT supply arms
- 3/4" MHT Outlet
- Mounting hardware included



Part #	Mfg #	Description	Cartridge	Aerator	Finish	Price
12147	897-CP	7-5/8" - 3-3/8"cc, 369 Metal ADA Levers w/Hot & Cold Indexes	Quatum™	-	CP	184.43

### 2-Handle Wall-Mount Exposed Service Sink Faucet with Ceiling Supplies, Vacuum Breaker Spout with Pail Hook & Wall Brace

- Solid brass body construction
- 1/2" FNPT Inlet
- Mounting hardware included
- 3/4" MHT Outlet
- Body support plate



Part #	Mfg #	Description	Cartridge	Aerator	Finish	Price
41915	835-CP	8"cc, 633 Metal Cross Handles w/Hot & Cold Indexes	Quatum™	-	CP	376.04
198092	835-RCF	8"cc, 633 Metal Cross Handles w/Hot & Cold Indexes	Quatum™	-	Rough	329.59



## Laundry & Utility Sink Faucets



### 2-Handle Wall Mounted Adjustable 7-1/4" - 8-3/4" Centers Sink Faucet

- GN1A - 3-1/2" C-C Rigid/Swing Gooseneck Spout
- E3 - 2.2 GPM (8.3 L/min) Pressure Compensating Softflo® Aerator
- 317 - 4" Metal Wrist blade Handles with Secured Red and Blue Service Buttons
- Quatum™ Operating Cartridges
- G - 3/8" Offset Adjustable Supply Arms with 1/2" NPT Female Thread Inlet



Part #	Mfg #	Description	Cartridge	Aerator	Finish	Price
12118	631-CP	7-1/4" - 8-3/4", 317 Metal Wrist blade Handles	Quatum™	E3	CP	211.78

### 2-Handle Deck Mounted - 3-3/8" Centers Faucet

- Sink Faucet
- S6 - 6" C-C Cast Brass Swing Spout
- E3 - 2.2 GPM (8.3 L/min) Pressure Compensating Softflo® Aerator
- 369 - 2-3/8" Metal Lever Handles with Secured Red and Blue Service Buttons
- Quatum™ Operating Cartridges
- W - Straight Supply Arms with 1/2" NPT Female Thread Inlets



Part #	Mfg #	Description	Cartridge	Aerator	Finish	Price
108993	772-CP	3-3/8" Centers, 369 Lever Handles	Quatum™	E3	CP	190.19

### 2-Handle Wall Mounted - Adjustable 8" - 13" Centers Sink Faucet

- Flushing Rim Sink Faucet
- 7 1/8" C-C Cast Spout with Pail Hook and Wall Brace
- Plain Outlet End
- 319 - 6" Metal Wrist blade Handles with Secured Red and Blue Service Buttons
- Quatum™ Operating Cartridges
- R - 2 1/2" Offset Adjustable Supply Arms with 1/2" NPT Female Thread Inlet and Integral Service
- 2" Inlet Supply Extensions



Part #	Mfg #	Description	Cartridge	Aerator	Finish	Price
39702	814-CP	8" - 13" Centers, 319 Metal Wrist blade Handles	Quatum™	E3	CP	422.64

### 2-Handle Deck Mounted - 4" Centers Faucet

- S6 - 6" C-C Cast Brass Swing Spout
- E3 - 2.2 GPM (8.3 L/min) Pressure Compensating Softflo® Aerator
- 369 - 2-3/8" Metal Lever Handles with Secured Red and Blue Service Buttons
- Quatum™ Operating Cartridges
- 1/2" NPSM Supply Inlets with Coupling Nut for 3/8" or 1/2" Flexible Riser



Part #	Mfg #	Description	Cartridge	Aerator	Finish	Price
51347	891-CP	4" Centers, 369 Lever Handles	Quatum™	E3	CP	162.94

Prices & specifications are subject to change.

Metropolitan Pipe offers FREE DELIVERY in the Greater Boston area.



## Laundry & Utility Sink Faucets

### Wall-Mounted Vertical Center Faucets 2-Handle Wall Mounted - 3" Vertical Centers Faucet

- Service Sink Faucet
- 3-3/8" C-C Rigid Gooseneck Spout
- E4F - 2.0 GPM (7.6 L/min) Rose Spray Outlet
- 369 - 2-3/8" Metal Lever Handles with Secured Red and Blue Service Buttons
- Quatum™ Operating Cartridges
- 3/4" NPT Male Thread Inlets



Part #	Mfg #	Description	Cartridge	Aerator	Finish	Price
159100	225-CP	3in Vertical Centers, 369 Metal Lever Handles	Quatum™	E4F	CP	209.72



### Laundry Faucets

#### 2-Handle Rough Brass Utility/Laundry Faucet

- 1/2" IPS Inlets On 3-1/2" Centers
- 6-1/8" Spout Reach
- Offset Legs For Wall Mounting
- Hose Thread Outlet
- ADA Compliant
- Rough Cast Brass Finish

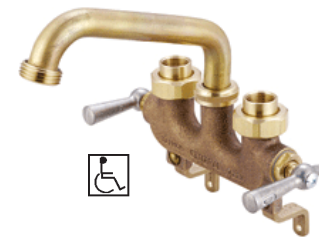

Part #	Mfg #	Description	Price
12088	0470	3-1/2"cc, ADA Levers, Offset Legs for Wall-Mount, RB	87.43

### Service Sink Faucets

#### 2-Handle Wall-Mount Service Sink Faucet

- 8-Inch Centers, 1/2-14 NPS Female Inlets
- 6-Inch Tube Spout with 2.0 GPM Flow Rate
- Replaceable Seats
- Brass Soap Dish
- PVD Polished Chrome



Part #	Mfg #	Description	Price
12073	0048-UA	8"cc, ADA Blades, Brass Soap Dish, CP	124.36





## Laundry & Utility Sink Faucets

GERBER.

### Two-Handle Laundry Faucets

#### 2-Handle Laundry Faucets - Cast Brass Underbody

- 1/2" IPS Connections with brass coupling nuts
- 2.2 gpm @ 60 psi



Part #	Mfg #	Description	Finish	Price
12764	49-244	4"cc ADA Metal Handles, Compression Stems, Hose End, 6" Swing Spout	Chrome	60.16



### Foot & Knee Operated Faucets & Controls

#### Deck-Mount Fitting with GN2 Rigid/Swing Gooseneck Spout

- Solid brass body construction
- 1/2" NPSM Coupling nut for 3/8" or 1/2" flexible riser
- Mounting hardware included



Part #	Mfg #	Description	Cartridge	Aerator	Finish	Price
108764	626-CP	1-Hole, GN2 Rigid/Swing Gooseneck Spout, Less Handles	-	-	CP	70.38
12115	626-E3CP	1-Hole, GN2A Rigid/Swing Gooseneck Spout, Less Handles	-	E3	CP	74.49

#### Wall-Mount Fitting with GN1 Rigid/Swing Gooseneck Spout

- Solid brass body construction
- 1/2" FNPT Flanged inlet
- Mounting hardware included



Part #	Mfg #	Description	Cartridge	Aerator	Finish	Price
12116	629-E3CP	1-Hole, GN1A Rigid/Swing Gooseneck Spout, Less Handles	-	E3	CP	86.22

### Wall Mounted Pedal Valve - Combination

- Combination Pedal Box
- One 3/8" NPT Female Back Outlet
- NAIAD™ Metering Self Closing Cartridges
  - SLO models: adjustable self closing.
- Two 1/2" NPT Female Thread Back Inlets
- ASME A112.18.1M
- CSA B125.1
- NSF 61, Section 9



Part #	Mfg #	Description	Cartridge	Aerator	Finish	Price
12114	625-CP	Combination Pedal Box	-	-	CP	205.17
39329	625-SLO-CP	Combination Pedal Box, Adjustable Closing	-	-	CP	208.96
51805	625-LPCP	Combination Pedal Box, Adjustable Closing, Long Pedals	-	-	CP	214.26

Prices & specifications are subject to change.

Metropolitan Pipe offers Vendor Managed Inventory - never run out of that part again!



## Laundry & Utility Sink Faucets

Plumbing

### Wall Mounted Pedal Valve - Combination

- Combination Pedal Box
- 3/8" NPT Female Thread Top Outlet
- Extended Pedals
- NAIAD™ Metering Self Closing Cartridges
  - SLO Model: adjustable closing.
- 1/2" NPT Female Thread Inlets



Part #	Mfg #	Description	Cartridge	Aerator	Finish	Price
12135	834-EPCP	Combination Pedal Box, Long Pedals	-	-	CP	429.28
40438	834-EPSLOCP	Combination Pedal Box, Long Pedals, Adjustable Closing	-	-	CP	429.28

### Wall Mounted Pedal Valve - Combination

- Convenient wall-mount installation and solid brass construction define this double-pedal foot control. A self-closing mixing valve and loose-key stops make it an easy choice.
- 3/8" NPT inside-threaded inlets
- 14" hinged foot pedals



Part #	Mfg #	Description	Cartridge	Aerator	Finish	Price
13855	K-13816	Combination Pedal Box, Long Pedals	-	-	CP	298.78

### Pedal Valves - Single

- Single Supply Pedal Box
- One 1/2" NPT Female Thread Top Outlet
- Short Pedal
- NAIAD™ Metering Non-adjustable Self Closing Cartridge
- 1/2" NPT Female Thread Back Inlet



Part #	Mfg #	Description	Cartridge	Aerator	Finish	Price
12117	628-CP	Single Supply Pedal Box	-	-	CP	151.87

### Wall Mounted - Knee Actuated Valve

- Knee Actuated Valve Assembly
- 3/8"-18 NPT Female Thread Outlet
- NAIAD™ Metering Non-adjustable Self Closing Cartridges
- Straight 1/2" NPT Female Thread Inlet Service Stops
- White Enameled Aluminum Wall Bracket



Part #	Mfg #	Description	Cartridge	Aerator	Finish	Price
37862	745-VOCP	Knee Actuated Valve Assembly	-	-	CP	615.96

Prices & specifications are subject to change.



## Laundry & Utility Sink Faucets



### Wall Mounted Pedal Valve - Bed Pan Cleaner

- Wall Mounted Pedal Valve Bed Pan Cleaner
- E21 - Rubber Bound Spray Outlet
- 834-EP - Wall Mounted Pedal Valve
- NAIAD™ Metering Non-adjustable Self Closing Cartridges
- 892-G - Elevated Atmospheric Vacuum Breaker with "G" 3/8" Offset Adjustable Supply Arms with 1/2" NPT Female Thread Inlet
- Vandal Resistant Mounting
- 4 Ft. White Vinyl Hose



Plumbing

Part #	Mfg #	Description	Cartridge	Aerator	Finish	Price
12156	910-GCP	Wall-mounted Pedal Valve Bed Pan Cleaner	-	-	CP	710.01

### Inside Hydrants & Sillcocks Wall Mounted Single Hole Inside Sillcock

- Inside Sill Fitting
- 2-3/8" C-C Atmospheric Vacuum Breaker Spout
- 3/4" Male Hose Thread Outlet
- 293-6 - 2-1/4" Metal Tee Handle
- Slow Compression Operating Cartridge
- 3/4" NPT Female Thread Inlet
- Atmospheric Vacuum Breaker, Not Intended for Continuous Pressure Applications



Part #	Mfg #	Description	Cartridge	Aerator	Finish	Price
12165	952-CP	1/2", Wall Mounted, Single Hole	-	-	CP	171.24
12166	952-CP	3/4", Wall Mounted, Single Hole	-	-	CP	171.24

### Wall Mounted Single Hole Sillcock

- Inside Sill Fitting
- 3/4" Male Hose Thread Outlet
- 293-6 - 2-1/4" Metal Tee Handle
- Slow Compression Operating Cartridge
- 3/4" NPT Female Inlet
- Slip Wall Flange



Part #	Mfg #	Description	Cartridge	Aerator	Finish	Price
108575	387-CP	3/4", Wall Mounted	-	-	CP	62.79

### Wall Mounted Single Hole Faucets

- Anti-siphon, vacuum breaker protected
- 120 psi max pressure
- 120F max temperature
- Poly carbonate wheel handle and loose tee key



Part #	Mfg #	Description	Cartridge	Aerator	Finish	Price
14901	24P-1/2	1/2", Wall Mounted, Single Hole	-	-	P	40.52
14902	24P-3/4	3/4", Wall Mounted, Single Hole	-	-	P	40.52

Prices & specifications are subject to change.

Our faucet parts counter is one of the largest in the Boston area with thousands of parts in stock!



# Laboratory Faucets

Plumbing

## Laboratory Faucets

### 1-Handle Deck-Mount Laboratory Faucet with GN2BVB Rigid/Swing Vacuum Breaker

- Single water fitting
- Solid brass body construction
- 3/8" FNPT Inlet or 1/2" MNPSM inlet
- Mounting hardware included
- Laboratory serrated nozzle outlet



Part #	Mfg #	Description	Cartridge	Nozzle	Finish	Price
12154	928-CP	1-Hole, 204 Cross Handles	Slow Compression	E7	CP	138.21
116308	928-317CP	1-Hole, 317 Wrist Handles	Slow Compression	E7	CP	142.41
207578	928-369CP	1-Hole, 369 Lever Handles	Slow Compression	E7	CP	136.61
160313	928-VRCP	1-Hole, 204 Cross Handles, Vandal Resistant	Slow Compression	E7	CP	193.49

### 1-Handle Deck-Mount Laboratory Faucet with GN2B Rigid/Swing Gooseneck Spout

- Single water fitting
- Solid brass body construction
- 1/2" NPSM Coupling nut for 3/8" or 1/2" flexible riser
- Mounting hardware included
- Laboratory serrated nozzle outlet



Part #	Mfg #	Description	Cartridge	Nozzle	Finish	Price
12158	927-CP	1-Hole, 204 Cross Handles	Slow Compression	E7	CP	103.36

### 2-Handle Deck-Mount Laboratory Faucet

- Solid brass body construction
- 3/8" OD Copper supply tubes
- Mounting hardware included
- Hot/cold water service buttons
- Laboratory serrated nozzle outlet



Part #	Mfg #	Description	Cartridge	Nozzle	Finish	Price
159614	929-CP	1-Hole, 204 Cross Handles	Slow Compression	E7	CP	177.68
183499	929-317CP	1-Hole, 317 Wrist Handles	Slow Compression	E7	CP	189.72

### 2-Handle Deck-Mount Laboratory Faucets with GN2BVB Rigid/Swing Gooseneck Spout

- Solid brass body construction
- 3/8" OD Copper supply tubes
- Mounting hardware included
- Handles indexed hot & cold
- Laboratory serrated nozzle outlet



Part #	Mfg #	Description	Cartridge	Nozzle	Finish	Price
12159	930-CP	1-Hole, 204 Cross Handles	Slow Compression	E7	CP	212.52
159759	930-GN8BVB-E7-CP	1-Hole, 204 Cross Handles, 8in Spout	Slow Compression	E7	CP	224.14
116312	930-317CP	1-Hole, 317 Metal ADA Wrist Blade Handles	Quatern™	E7	CP	220.94



## Laboratory Faucets

### 2-Handle Wall-Mount Laboratory with GN2BVB Rigid/Swing Vacuum Breaker

- Solid brass body construction
- 1/2" FNPT Flanged inlet
- "G" Adjustable 1/2" FNPT supply arms
- Mounting hardware included
- 932-001K - 1/2" MNPT Inlet shanks required for installation
- Handles indexed hot & cold
- Laboratory serrated nozzle outlet



Plumbing

Part #	Mfg #	Description	Cartridge	Nozzle	Finish	Price
12163	943-CP	8"cc, 204 Cross Handles	Slow Compression	E7	CP	229.95

### 2-Handle Deck-Mount Laboratory Faucet with GN2BVB Rigid/Swing Vacuum Breaker Gooseneck Spout

- Solid brass body construction
- "SS" 1/2" FNPT Short angle supply arms
- Mounting hardware included
- 748-002K - 1/2" MNPT Inlet shank assemblies shipped loose
- Handles indexed hot & cold
- Laboratory serrated nozzle outlet



Part #	Mfg #	Description	Cartridge	Nozzle	Finish	Price
12164	947-CP	8"cc, 204 Metal Cross Handles	Quatum™	E7	CP	253.16
37589	947-317CP	8"cc, 317 Metal ADA Wrist Blade Handles	Quatum™	E7	CP	303.22

### 1-Handle Deck-Mount Pure Water Fitting with Serrated Hose Nozzle

- Polypropylene gooseneck spout & valve body assembly
- PTFE Liner with chrome plated brass housing
- 3/8" MNPT Polypropylene inlet
- Mounting hardware included
- Laboratory serrated nozzle outlet



Part #	Mfg #	Description	Finish	Price
92422	828-CP	1-Hole, 3-Arm Polypropylene Handle & Valve Body Assembly & Cartridge	CP	452.91

### 1-Handle Pure Water Fitting with Tygon® Lined Spout and Integral Serrated Hose Nozzle

- Chrome plated gooseneck spout
- 1/2" MNPT Inlet
- Mounting hardware included
- Laboratory serrated nozzle outlet



Part #	Mfg #	Description	Finish	Price
12136	838-CP	1-Hole, Self Closing Push/Pull Lock Handle, Celcon® Valve, Deck Mount	CP	406.46
41435	839-CP	1-Hole, Self Closing Push/Pull Lock Handle, Celcon® Valve, Wall Mount	CP	467.42

Prices & specifications are subject to change.

Our office hours are 7am to 4:30pm and counter hours 6am to 4:30pm Monday through Friday.



## Laboratory Faucets

Plumbing

### 1-Handle PVC Distilled Water Fitting with Integral Serrated Hose Nozzle

- PVC Gooseneck spout with PVC valve
- 3/8" FNPT Inlet or 1/2" Male NPSM inlet
- Mounting hardware included
- Laboratory serrated nozzle outlet



869-BPVC      870-BPVC

Part #	Mfg #	Description	Finish	Price
12138	869-BPVC	1-Hole, 3-Arm PVC Handle, PVC Valve, Deck Mount	Black	280.93
43925	870-BPVC	1-Hole, 3-Arm PVC Handle, PVC Valve, Wall Mount	Black	180.97

### 1-Handle Deck-Mount Distilled Water Fittings with GN2B Rigid/Swing Gooseneck Spout with Tin Lining

- Tin lined body & cartridge
- 1/4" MNPT Inlet tailpiece
- Mounting hardware included
- Laboratory serrated nozzle outlet



Part #	Mfg #	Description	Cartridge	Nozzle	Finish	Price
12170	969-CTF	1-Hole, 204 Cross Handle with DW Service Button	Self-Closing	E7	CTF	207.88
46415	969-217XLHCTF	1-Hole, 204 Cross Handle with DW Service Button	Slow Compression	E7	CTF	202.06

### 1-Handle Deck-Mount Distilled Water Fittings with GN2B Rigid/Swing Gooseneck Spout with Tin Lining

- Tin lined body & cartridge
- 1/2" MNPT Inlet tailpiece
- Mounting hardware included



Part #	Mfg #	Description	Cartridge	Aerator	Finish	Price
12171	970-CTF	1-Hole, 204 Cross Handle with DW Service Button	Self-Closing	E7	CTF	193.86

## Laboratory Fittings

### 1-Handle Remote Control Laboratory Valves for 45° Angle Panels

- Wall-mount flange & extension rod
- Solid brass body construction
- 3/8" FNPT Inlet and outlet



Part #	Mfg #	Description	Cartridge	Finish	Price
12169	962-VOGCP	1-Hole, 204 Cross Handle with Gas Service Button, Straight	Needle Valve	CP	77.81
239252	962-VOGAAGVCP	1-Hole, 204 Cross Handle with AGV Service Button, Angle	Needle Valve	CP	77.81



## Laboratory Faucets

### Turrets & Flanges



Part #	Mfg #	Description	Price
12178	986-CP	Wall Flange, 3/8" NPT Female Outlet	19.76
12179	986-FCP	Wall Flange, 3/8" NPT Female Outlet Thread	12.78
52658	987-CP	Y Pattern Wall Flange with Two Outlets @ 90°, (2) 3/8" NPT Female Thread Outlets	30.20
12181	987-FCP	Y Pattern Wall Flange with Two Outlets @ 90°, (2) 3/8" NPT Female Thread Outlets	23.23
21107	E7JK	Laboratory Serrated Nozzle Outlet	15.13
203878	E7TCJK	Laboratory Serrated Nozzle Outlet, with Check Valve	12.97

### Turrets

- Polished chrome plate finish
- 957-003K 3/8" NPT Inlet shank required for installation
- 3/8" FIP Inlet/outlet



Part #	Mfg #	Description	Price
12173	980-CP	Turret with One Side Outlet, 3/8" NPT Female Outlet Thread	19.76
12174	981-CP	Turret with Two Side Outlets @ 180°, (2) 3/8" NPT Female Thread Outlets	23.23
12175	982-CP	Turret with Two Side Outlets @ 90°, (2) 3/8" NPT Female Thread Outlets	23.23
109418	983-CP	Turret with Three Outlets, (3) 3/8" NPT Female Thread Outlets	29.39
12177	984-CP	Turret with Four Side Outlets @ 90°, (4) 3/8" NPT Female Thread Outlets	25.57

### 1-Handle Wall-Mount Gas Fitting

- Ball Valve
- 3 1/8" Metal Lever Handle with Gas Service Button
- Chrome Plated Brass Ball with Teflon™ Seats
- 3/8" NPT Male Thread Inlet
- 909 Valve is certified for gas service per ANSI Z21.15B-2006/CSA by the Canadian Association



Part #	Mfg #	Description	Price
181015	909-AVGCP	E7 - Serrated Hose Nozzle Outlet	24.68
173665	909C-GAS-CP	E7TC - Serrated Hose Nozzle Outlet with Check Valve	29.78

### 1-Handle Wall-Mount Single Water Fitting

- Single water inlet
- 3/8" MNPT Inlet



Part #	Mfg #	Description	Cartridge	Aerator	Finish	Price
12161	937-CP	937-2 Cross Handle, 3/8" MNPT Inlet	Slow Compression	E7	CP	62.72
873732	937-CHAGV-CP	937-2 Cross Handle, 3/8" MNPT Inlet	Needle Valve	E7	CP	67.36
166259	937-CHCHECK-CP	937-2 Cross Handle, 3/8" MNPT Inlet	Needle Valve	E7TC	CP	82.49



## Tub & Shower Faucets

Plumbing

### Temptrol® Tub & Shower Systems

#### S-96-1 - 1-Handle Shower Faucets

- Features Temptrol® pressure-balancing mixing valve
- Integral volume control
- Clear-Flo shower head with arm and flange
- Adjustable stop screw
- Wall connection and flange



Part #	Mfg #	Description	Handle(s)	Finish	Price
14458	S-96-1	Shower Only	Tri	Chrome	206.65
14459	S-96-1-X	Shower Only, Integral Service Stops	Tri	Chrome	232.80

#### S-96-2 - 1-Handle Tub & Shower Faucets

- Features Temptrol® pressure-balancing mixing valve
- Combination integral diverter/volume control
- Clear-Flo shower head with arm and flange
- Adjustable stop screw
- Tub spout



Part #	Mfg #	Description	Handle(s)	Finish	Price
14460	S-96-2	Tub & Shower Complete	Tri	Chrome	217.20
14461	S-96-2-X	Tub & Shower Complete, Integral Service Stops	Tri	Chrome	243.35

#### S-96-300 - 1-Handle Wall/Hand Spray Shower System

- Features Temptrol® pressure-balancing mixing valve
- Integral volume control
- Adjustable stop screw
- Wall/hand shower with flexible metal hose
- In-line vacuum breaker
- Wall connection and flange



Part #	Mfg #	Description	Handle(s)	Finish	Price
36004	S96-300-B30-L-V-X	Shower Only, 30" Slide bar, Integral Service Stops	ADA Blade Lever	Chrome	497.80

#### 96-500 - 1-Handle Wall/Hand Spray Shower System

- Features Temptrol® pressure-balancing mixing valve
- Clear-Flo shower head with arm and flange
- In-line vacuum breaker
- Flexible metal hose
- Wall connection and flange



Part #	Mfg #	Description	Handle(s)	Finish	Price
36464	96-500-B30-L-V-X	Shower Only, 30" Slide bar, Integral Service Stops	ADA Blade Lever	Chrome	671.70

Prices & specifications are subject to change.





## Tub & Shower Faucets



### Allura™ Tub & Shower Systems Symmons Allura® Shower System S-4701

- Symmons Temptrol® pressure balancing mixing valve with adjustable stop screw to limit handle turn.
- Secondary integral volume control handle
- Three mode shower head with arm and flange
- Flow rate, 2.5 gpm (9.5 L/min)
- Polished chrome finish (standard)
- Includes integral service stops to allow water shut-off for service
- Replacing the S-76 system



Plumbing

Part #	Mfg #	Description	Handle(s)	Finish	Price
906201	S-4701-X	Shower Only, Integral Service Stops	Lever Handle	Chrome	277.30

### Symmons Allura® Tub/Shower System S-4702

- Symmons Temptrol® pressure balancing mixing valve with adjustable stop screw to limit handle turn.
- Secondary integral diverter/volume control handle
- Showerhead, #4-143, 3 mode flood, mist or pulse spray
- Showerhead mounting arm and flange
- Showerhead, 2.5 gpm (9.5 L/min) standard flow rate
- Tub spout
- Polished chrome finish



Part #	Mfg #	Description	Handle(s)	Finish	Price
916570	S-4702-X	Tub & Shower, Integral Service Stops	Lever Handle	Chrome	291.35

### Safetymix Commercial Shower Systems 1-100-X 1-Handle Tub & Shower Faucet

- Symmons Safetymix® Pressure-Balancing mixing valves are designed and built to last the life of the building.
- Designed to withstand the rigors of a high use commercial or institutional project
- 4-500 3-port valve, 4-231 shower head, 300 arm and flange
- Integral service stops - allows water shut off at valve for service. Recommended for use on all multiple commercial installations



Part #	Mfg #	Description	Handle(s)	Finish	Price
14405	1-100-X	Tub & Shower Complete, Integral Service Stops	Lever	Chrome	544.21



## Tub & Shower Faucets

Plumbing

### 1-117-FS-B30-X 1-Handle Tub & Shower Faucet

- Safetymix Shower Unit with Open Flow Hand Spray
- 4-500 3-port valve, 4-458 lever diverter, FS hand spray, 4-231 shower head, 300 arm and flange
- B30 - 30" adjusting bar in place of wall hook on hand spray units
- Integral service stops - allows water shut off at valve for service. Recommended for use on all multiple commercial installations



Part #	Mfg #	Description	Handle(s)	Finish	Price
51366	1-117-FS-B30-X	Tub & Shower Complete, with Hand Spray, Integral Service Stops, 30in Adjusting Bar	Lever	Chrome	871.39

### Visu-Temp Shower Systems

#### 1-1000-VTX Visu-Temp with Clear-Vue Shower System 1-Handle

- The perfect shower is now right before your eyes. Quickly set the temperature of any shower or bath with the Clear-Vue thermometer.
- Visu-Temp with Clear-Vue Shower Unit, 4-5000VT valve, 4-241 shower head, 300 arm and flange.
- Integral service stops - allows water shutoff at valve for service. Recommended for use on all multiple or commercial installations



Part #	Mfg #	Description	Handle(s)	Finish	Price
874371	1-1000-VTX	Tub & Shower Complete, Integral Service Stops Visu-Temp Clear-Vue Thermometer Gauge	Lever	Chrome	560.62

#### 1-1000-VTX Visu-Temp with Clear-Vue Shower System 1-Handle, with Hand Spray

- The perfect shower is now right before your eyes. Quickly set the temperature of any shower or bath with the Clear-Vue thermometer.
- Safetymix Visu-Temp Shower Unit with Hand Spray, 4-5000VT, 4-458 lever diverter, FS hand spray, 4-231 shower head, 300 arm and flange.
- B30 - 30" adjusting bar in place of wall hook on hand spray units
- X - Integral service stops - allows water shut off at valve for service. Recommended for use on all multiple or commercial installations



Part #	Mfg #	Description	Handle(s)	Finish	Price
14408	1-117-VT-FS-B30-X	Tub & Shower Complete, with Hand Spray, Integral Service Stops, 30in Adjusting Bar Visu-Temp Clear-Vue Thermometer Gauge	Lever	Chrome	874.66



## Tub & Shower Faucets

### Rite-Temp Series Tub & Shower Systems

Valve and trim sold separately.

#### Rite-Temp Pressure-Balancing Valve

- The valve features a high-temperature limit stop and an optimal comfort zone, so you can set a maximum high and then find and maintain your desired water temperature. Additionally, the unit has a diaphragm design that virtually eliminates freeze-ups from contamination and water debris.
- Back-to-back installation is ideal for unique or high-volume jobs
- Provides anti-scald protection and temperature regulation at flow rates as low as 1.75 gpm; far below federally mandated standards of 2.5 gpm
- Large internal ports allow quick bath filling
- Mounting tabs located on rough-in for secure installation option



Part #	Mfg #	Description	Price
133455	K-304-K-NA	Pressure-balancing valve without screwdriver stops	83.99
124688	K-304-KS-NA	Pressure-balancing valve with screwdriver stops	98.54

#### Rite-Temp Pressure-Balancing Valve - With Diverter

Part #	Mfg #	Description	Price
936027	K-11748-K-NA	Pressure-balancing valve without screwdriver stops	127.82
934459	K-11748-KS-NA	Pressure-balancing valve with screwdriver stops	144.12

#### Rite-Temp Tub & Shower Trims



Part #	Mfg #	Description	Lever	Finish	Price
153486	KT-12007-4-CP	Fairfax Tub & Shower Trim	Metal	Chrome Plated	107.24
929778	KT-13492-4-CP	Kelstone Tub & Shower Trim	Metal	Chrome Plated	114.25
872270	KT-10581-4-CP	Bancroft Tub & Shower Trim	Metal	Chrome Plated	209.94
877151	KT-10581-4P-CP	Bancroft Tub & Shower Trim	Ceramic, White	Chrome Plated	209.94
904721	KT-11077-4-CP	Archer Tub & Shower Trim	Metal	Chrome Plated	116.53
861607	KT-395-4-CP	Devonshire Tub & Shower Trim	Metal	Chrome Plated	97.30
232941	KT-395-4-BN	Devonshire Tub & Shower Trim	Metal	Brushed Nickel	224.24
234589	KT-10274-4-CP	Forte Tub & Shower Trim	Metal	Chrome Plated	95.37

Prices & specifications are subject to change.

Our state of the art pipe shop offers cutting, threading, grooving and make-ons up to 36in!



## Tub & Shower Faucets

### MasterShower Series Tub & Shower Systems

Valve and trim sold separately.

#### MasterShower® Thermostatic Valves

Valve and trim sold separately.

- Forged brass valve body
- Single-handle temperature control
- High-temperature limit setting for added safety
- Temperature-balancing mechanism
- Scald hazard prevention
- Integral stops
- Crossflow prevention
- 1/2" or 3/4" NPT connections (see below for model)
- Filter screens
- Single outlet
- Less volume control



K-2972-KS-NA



K-2975-KS-NA

Part #	Mfg #	Description	Price
953541	K-2972-KS-NA	MasterShower® 1/2" thermostatic valve	206.14
953540	K-2975-KS-NA	MasterShower® XVII 3/4" thermostatic valve	335.12

### Mastershower® 2- or 3-way Transfer Valve

- Brass construction
- Wall-mount
- Brass valve body
- Selection of one or combination of two outlets
- Single-handle control
- One 3/4" NPT inlet connection
- Three 1/2" NPT outlet connections
- Intended for use with Kohler® bath and shower supply valves
- Can be converted from 3 outlets (360° handle rotation) to 2 outlets (120° handle rotation)



Part #	Mfg #	Description	Price
935408	K728-K-NA	Mastershower® 2- or 3-way Transfer Valve	128.10

### Kohler K-2974-K-NA MasterShower 1/2" Volume Control

- This Kohler 1/2" volume control valve allows individualized control of showerheads, handshowers and bodysprays. Choose any combination or experience all of the components at the same time.
- 3/4" inlet 1/4-turn ceramic disc valve
- Volume control enables precise control of amount and intensity of water flow
- Kohler Lifetime Limited Warranty
- Replacement for: Kohler K-681-K-NA
- Mounting Tabs: Allows valve to be mounted Reduced Height & Size (25%-30% mass reduction): Leaves more room to locate valve and plumbing between studs
- Minimizes standing water for faster warm-up



Part #	Mfg #	Description	Price
953542	K-2974-K-NA	1/2" volume control valve - for use on bath and shower outlets	49.05



## Tub & Shower Faucets

### MasterShower Tub & Shower Trims

- Serene and soothing, the Purist® line of faucets is a calming force in any modern bath or powder room. Paired with a KOHLER® volume control valve, this Purist volume control valve trim allows each individual water outlet to have its own flow control. Offered in an array of stain- and corrosion-resistant Vibrant® PVD color finishes, it ensures reliable performance and promises an inviting visual appeal.
- Margaux offers a unique blend of traditional design elements and modern fluidity to complement eclectic design interiors with refreshed sophistication.
- KOHLER finishes resist corrosion and tarnishing, exceeding industry durability standards over two times
- Fluid design lines for ease of cleaning
- Features MasterClean™ spray face that resists mineral buildup and is easy to clean



Margaux Series

Purist Series

### Margaux Series

Part #	Mfg #	Description	Handle	Finish	Price
903746	KT-16233-4-CP	Margaux Tub & Shower Trim	Metal	Chrome Plated	335.37
903747	KT-16234-4-CP	Margaux Shower Trim	Metal	Chrome Plated	250.55

### Purist Series

Part #	Mfg #	Description	Handle	Finish	Price
235510	KT-14420-4-CP	Purist Tub & Shower Trim	Metal	Chrome Plated	382.92
861673	KT-14490-4-CP	Purist Control Trim Only	Metal	Chrome Plated	111.50



### Grohsafe Tub & Shower Systems

Valve and trim sold separately.

#### Grohsaf Universal Pressure Balance Rough - In Valve

- Handle Limit Stop
- Diaphragm Cartridge
- Check Valves
- Built-In By-Pass
- Service Stops
- Includes cap and plug for 3 port installation
- Universal connection is 1/2" male by copper sweat



Part #	Mfg #	Description	Price
911321	35015 000	Universal Pressure Balance Rough-In Valve	114.31



## Tub & Shower Faucets

Plumbing

### Grohsafe Tub & Shower Trims

- Single Lever Handle
- Non-Adjustable Shower Head (28 342)
- Brass Arm (27 414)
- Diverter Tub Spout (13 611)
- For use with Grohsafe® Pressure Balance Rough-In Valve 35 015 (sold separately)



Part #	Mfg #	Description	Handle	Finish	Price
904001	35009 000	Concerto Tub & Shower Trim	Metal	Chrome	163.60
938498	35012 001	Eurosmart Tub & Shower	Metal	Chrome	Call

### Grotherm Tub & Shower Systems

Valve and trim sold separately.

#### Grotherm Thermostatic Rough-In Valve

- Paraffin cartridge
- NPT female connections
- Built-in check valves
- Service stops
- Temperature control only
- GROHE TurboStat® Technology
- Separate volume control required
- Requires Twin Ell for shower/tub combinations with diverter tub spout



Part #	Mfg #	Description	Price
237985	34122 000	1/2" Thermostatic Rough-In Valve	235.72
861580	34124 000	3/4" Thermostatic Rough-In Valve	415.46

### Grotherm Tub & Shower Trims

- Requires separate volume control
- For use with Grotherm 34 122 (1/2") or 34 124 (3/4") thermostat rough-in valve



Part #	Mfg #	Description	Handle	Finish	Price
228985	19615 000	Geneva Thermostatic Trim	Cross, Metal	Chrome	231.77
859809	19616 000	Geneva Thermostatic Trim	Lever, Metal	Chrome	217.30
213227	19612 000	Seabury Thermostatic Trim	Cross, Metal	Chrome	168.54
234750	19614 000	Seabury Thermostatic Trim	Lever, Metal	Chrome	205.00

Prices & specifications are subject to change.



## Tub & Shower Faucets



### Grohe Volume Control Valves

Valve and trim sold separately.  
 Volume Control Rough-In Valve



- Female NPT connections
- Ceramic cartridge

Part #	Mfg #	Description	Price
237990	29273 000	1/2" FNPT Volume Control Rough-In Valve	51.25
857951	29274 000	3/4" FNPT Volume Control Rough-In Valve	82.78

### Grohe Volume Control Handles



19829

19837

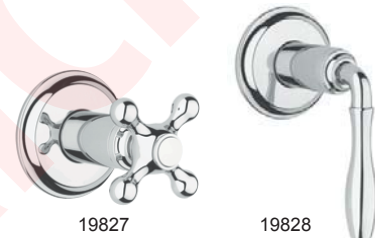

19827

19828

Part #	Mfg #	Description	Handle	Finish	Price
228986	19829 000	Geneva Volume Control Trim	Cross, Metal	Chrome	129.29
859914	19837 000	Geneva Volume Control Trim	Lever, Metal	Chrome	127.73
213228	19827 000	Seabury Volume Control Trim	Cross, Metal	Chrome	89.62
234752	19828 000	Seabury Volume Control Trim	Lever, Metal	Chrome	109.00



### Tub & Shower Faucets

Leg Tub Fittings with Quick-Pression  
 1/4-Turn Stems

- 3/4-14 NPS Male shanks x 2-1/8" long
- Replaceable seats
- PVD Chrome Polished



0210-Q

0211-Q

Part #	Mfg #	Description	Price
12076	0210-Q	3-3/8"cc, 4-Arm Top Handles, CP	64.05
12077	0211-Q	2-1/2"-8-1/2"cc, 4-Arm Top Handles, CP	167.23

## Vendor Managed Inventory Program

Metropolitan Pipe can assist you in setting up your own *stockroom*- complete with barcodes for easy tracking.

 Product ID: 454645

Kohler 4330-0 Kingston elongated wall-hung bowl with top spud



Aisle 7 - Shelf B



## Tub & Shower Faucets

Plumbing

### 1-Handle Self-Closing Shower Stop:

- Self-Closing Cast Brass Shower Stop
- 1/2 - 14 NPS
- With 18-Inch Pull Chain
- Replaceable Seats
- PVD Polished Chrome



Part #	Mfg #	Description	Price
12082	0335-1/2	ADA Lever, Pull Chain, CP	63.58



**\*As of December 31, 2011, The Alsons brand has been integrated into Delta Faucet company.**

### Showerheads

- Utilizes brass ball connector to attach shower head to water supply
- Energy efficient - meets all industry codes

#### Incredible Head® Power Shower™

- Solid brass
- Forceful, full spray
- On/off button slows water to a trickle when in off position



Part #	Mfg #	Description	Price
209067	52652-PK	Chrome	11.73

### 5-Spray Massage Showerhead

- Touch-Clean® Showerhead: Rubber spray holes allows easy cleaning with the touch of a finger.
- 3 1/2" Spray face diameter
- Lifetime Faucet and Finish Warranty



Part #	Mfg #	Description	Price
123436	52635-PK	Chrome	23.45

## Chatham

### Shower Heads

#### Precise Flow Control Showerhead

- Self-cleaning tight spray pattern
- Removable faceplate
- 2.5 gpm @ 10-80 psi

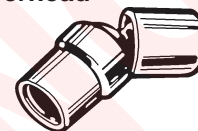

Part #	Mfg #	Description	Price
39808	102S	Forged Brass, CP	30.60



### Shower Heads

#### Wall-Mount Institutional Showerhead

- Solid brass body construction
- 20" - 30" Adjustable spray angle
- 1/2" FNPT Inlet
- Tamper resistant
- Mounting hardware included



Part #	Mfg #	Finish	Price
108756	621-CP	Chrome-Plated	99.79

#### Showerhead with Ball Joint and Pressure Compensating Flow Control

- Solid brass body construction
- 2.5 gpm Max flow rate @ 80 psi
- 1/2" FNPT Inlet
- Mounting hardware included



Part #	Mfg #	Finish	Price
135348	620-CP	Chrome-Plated	45.59



### Shower Heads

#### Act-O-Matic Shower Heads

- 2.5 gpm
- Self-cleaning
- Chrome-plated



AC11



AC450-4

Part #	Mfg #	Mfg Part#	Description	Price
37084	4020100	AC-11	Standard	70.29
38228	4024500	AC-450-A	Institutional-Style	162.88

Prices & specifications are subject to change.





## Shower Fixtures



### Hand Showers

#### Croma E 75 Green Hand Shower

- Features Quiclean cleaning system
- Drenching full spray
- 50 no-clog spray channels
- 1.6 GPM flow (feels like 2.5 GPM)
- EcoAIR technology



Part #	Mfg #	Description	Price
896358	06497000	Chrome	37.32

#### Croma C 75 2-Jet Hand Shower

- Traditional design
- 2 spray modes: full and massage spray
- Features Quiclean cleaning system
- 40 no-clog spray channels



Part #	Mfg #	Description	Price
896359	06127000	Chrome	53.31

#### Green 3-Jet Hand Shower

- Oversized 4" spray face
- Features Quiclean function
- Full spray, massage and intense massage
- EcoAIR technology
- AIR-injection technology
- 75 no-clog spray channels
- Flow 1.75 GPM, 30% savings



Part #	Mfg #	Description	Price
908508	04083000	Chrome	70.96

#### Croma E 75 3-Jet Hand Shower

- 3 spray modes: full, massage and turbo massage
- 40 no-clog spray channels
- Features Quiclean cleaning system



Part #	Mfg #	Description	Price
863667	28573001	Chrome	48.74

#### Croma E 75 3-Jet Sam

- Shower arm mount
- 63" techniflex hose
- Croma 3-Jet hand shower with full, massage and mono sprays
- Replaces shower head



Part #	Mfg #	Description	Price
896360	06495000	Chrome	97.48

### Hand Shower Holders

#### Axor Phoenix Porter'E Holder

- Integrated hose connection
- 1/2" NPT female inlet
- Hand Shower holder adjustable to 6 positions
- Wall mounted
- Fits all hoses with a conical nut



Part #	Mfg #	Description	Price
895392	27508821	Brushed Nickel	135.56

#### Commercial Porter'E Holder

- Wall Mounted, 1 position hand shower holder
- Fits all hoses with a conical nut



Part #	Mfg #	Description	Price
893045	28321003	Chrome	21.33

### Shower Heads

#### Clubmaster Showerhead

- 3 spray modes: full, pulsating massage and soft aerated
- Solid brass shell
- 72 no-clog spray channels
- Features Quiclean cleaning system
- Includes rubber boot



Part #	Mfg #	Description	Price
859919	28496001	Chrome	127.94
890160	28496821	Brushed Nickel	226.94

Prices & specifications are subject to change.

Our faucet parts counter is one of the largest in the Boston area with thousands of parts in stock!



# Shower Fixtures



Plumbing

### Croma C 75 2-Jet Showerhead

- Traditional design
- 2 spray modes: full and massage spray
- Features Quiclean cleaning system
- 40 no-clog spray channels



Part #	Mfg #	Description	Price
896114	06126000	Chrome	50.19

### Croma E 100 Green 3-Jet Showerhead

- Oversized 4" spray face
- Features Quiclean function
- Full spray, massage and intense massage
- EcoAIR technology
- AIR-injection technology
- 75 no-clog spray channels
- Flow 1.75 GPM, 30% savings



Part #	Mfg #	Description	Price
908507	04081000	Chrome	51.79

### Tub Fillers

#### Solaris Trim, 3-Hole Roman Tub Set

- Solid brass spout
- Easy to clean
- ADA compliant

Needs rough # 06607000



Part #	Mfg #	Description	Price
895390	06630000	3-Hole, Chrome	303.10

## SPEAKMAN®

### Anystream® Shower Heads

- 2.5 gpm Flow control
- Brass ball swivel joint, Brass shank
- Self-cleaning Lexan® deposit resisting spray jets
- Meets ANSI standards

#### 6-Jet Anystream® Showerhead

- 2-3/4" Face, 1/2" NPTF inlet
- (48) Spray channels
- Spray adjusting T-handle



Part #	Mfg #	Finish	Price
14318	S-2252-AF	Polished Chrome	63.17

### 5-Jet Anystream® Showerhead

- (50) Powerful full-body sprays
- (8) Center pulsating massage jets
- Spray adjusting T-handle
- Volume & velocity ring
- 3-1/2" face diameter



Part #	Mfg #	Finish	Price
143498	S-2005	Polished Chrome	47.17

### 4-Jet Anystream® Showerhead

- 2-1/4" Face, 1/2" NPTF inlet
- (32) Spray channels
- Chrome plated shank
- Spray adjusting T-handle



Part #	Mfg #	Finish	Price
14320	S-2253-AF	Polished Chrome	38.75

### Brass Shower Heads

#### 2-1/4" Brass Shank

- 2.5 gpm Flow control
- Brass ball swivel joint
- Spray adjusting T-handle
- Brass face, 1/2" NPTF inlet



Part #	Mfg #	Finish	Price
14325	S-2291-AF	Polished Chrome	29.48

#### 1-3/4" Brass Shank

- 2.5 gpm Flow control
- Brass ball swivel joint
- Spray adjusting T-handle
- Brass face, 1/2" NPTF inlet



Part #	Mfg #	Finish	Price
14326	S-2292-AF	Polished Chrome	25.27



### Hand Showers

#### Lady Adjustable Spray Hand Shower

- Adjustable narrow, mixed & full spray settings



Part #	Mfg #	Description	Price
11806	59480	Chrome, Boxed	80.51



# Hand Showers



## Massage Action or Full Spray Hand Shower

- Fast massage & full spray settings



Part #	Mfg #	Description	Price
194265	59465-PK	Chrome, Retail Pkg	25.02

## Massage Action or Full Spray Hand Shower

- Fast & slow massage, full spray with full spray & pause control settings



Part #	Mfg #	Description	Price
123434	59435-PK	Chrome, Retail Pkg	35.96

## Full Spray Hand Shower



Part #	Mfg #	Description	Price
11802	462-PK	White, Boxed	16.42

## Full Spray with Push Button Pause Control Hand Shower

- Full spray & pause control settings



Part #	Mfg #	Description	Price
11803	59462-WHB-PK	White, Boxed	18.76

## Shower Hoses

### Metal/Steel Shower Hoses



- One conical and one hex all-brass nut
- Lifetime Finish Warranty

Part #	Mfg #	Description	Price
11811	U495D-60-PK	60" - 82" Stretchable Metal Shower Hose	28.14
11812	U495S-69-PK	69" Stainless Steel Shower Hose	26.58

## Reinforced Vinyl Shower Hoses



- UltraFlex® Black/Chrome Ribbon Hose
- Two chrome metal conical hose nuts
- Lifetime Finish Warranty

Part #	Mfg #	Description	Price
11807	U490R-60-PK	60" Black/Chrome	21.89
122707	U490R-70-PK	70" Black/Chrome	24.23

## Swivel Connectors

### Handshower Swivel Connectors



- Use with pin-mounts

Part #	Mfg #	Description	Price
11817	U5002-PK	Metal, Chrome Plated	20.33
11799	U4002-PK	Plastic, Chrome Plated	11.73
53530	U4002-WN-PK	Plastic, White	10.17

## Shower Arm Mounts

### Shower Arm Pin Mounts

- Metal construction
- For use with pin-mount swivel connectors
- Lifetime Finish Warranty



Part #	Mfg #	Description	Price
11800	U4301-PK	Chrome Plated	16.42

## Wall Bars

### 24" Adjustable Pin Mount Wall Bar



- Brass construction
- Concealed installation screws
- Lifetime Finish Warranty

Part #	Mfg #	Description	Price
11798	55024	Chrome Plated	84.41



## Shower Accessories

### 30" Adjustable Glide Rail Wall Bar



- With pin mount
- Adhesive or screw installation
- Lifetime Finish Warranty

Part #	Mfg #	Description	Price
55250	55531	Chrome Plated	85.98

### Atmospheric Vacuum Breaker



- Atmospheric design
- Brass shield
- 1/2" connections
- Lifetime Finish Warranty

Part #	Mfg #	Description	Price
11808	U4900-PK	Chrome Plated, Brass Shield	21.11

### Pin Wall Mounts

#### Pin Wall Mounts for Handshowers



U5001-PK

U5001-A-PK

U9501-PK

- Use with pin-mount swivel connectors
- Lifetime Finish Warranty

Part #	Mfg #	Description	Price
45979	U5001-PK	Chrome Plated Plastic, with Mounting Screws - Clear Pin	10.95
35711	U5001-A-PK	Chrome Plated Plastic, Self-adhesive Mount	9.38
183206	U9501-PK	Chrome Plated Brass with Mounting Screws	23.45

### Bar Slides

#### Bar Slide and Knobs



- Chrome plated
- Limited Finish Warranty

Part #	Mfg #	Description	Price
119792	BAS-3-BX	Chrome	21.11
139678	BAS-4-BX	Clear Knob	9.38

### Shower Diverters

#### Shower Arm Diverter for Handshower



- Brass construction
- Lifetime Finish Warranty

Part #	Mfg #	Description	Price
11809	U4922-PK	Chrome Plated Brass	19.54

### Replacement Parts

#### 1/2" Replacement Gasket



- Fits Alsons & Delta shower accessories

Part #	Mfg #	Description	Price
18658	4959B6	1/2" Replacement Gasket	0.55

### 3-Way Shower Arm Diverter

- Diverts water between handshower and showerhead
- Brass construction
- One inlet and two outlets
- Lifetime Finish Warranty



Part #	Mfg #	Description	Price
11810	U4923-PK	Chrome Plated Brass	37.52

### Water Outlet Components

#### Wall Supply Elbow for Handshower

- Replaces standard shower arm
- Brass construction
- 1/2" connections
- Lifetime Finish Warranty



Part #	Mfg #	Description	Price
211095	U4980-PK	Chrome Plated Brass	28.92



# Flush Valves

**SLOAN.**

Plumbing

## Manual Flushometers

### Royal® Diaphragm Type Exposed Parts Flushometers

- Dual filtered by-pass
- Diaphragm, handle packing, stop seat & vacuum breaker molded from PERMEX™ rubber compound for chloramine resistance
- ADA Compliant metal oscillating non-hold-open handle with triple seal handle packing
- Free spinning vandal resistant stop cap
- Adjustable tailpiece
- High back pressure vacuum breaker flush connection with 1-piece bottom hex coupling nut
- Sweat solder adapter with cover tube and case set screw wall flange
- Valve body, cover, tailpiece & control stop manufactured per ASTM alloy class for semi-red brass
- Valve in compliance with applicable sections of ASSE 1037, ANSI/ASME 112.19.6 & military specification V-29193



### Royal® Models 110/111 Exposed Water Closet Flushometers

- Exposed water closet flushometer, for floor mounted or wall hung top spud bowls
- 1" IPS Screwdriver Bak-Chek™ angle stop
- Spud coupling & flange for 1-1/2" top spud

Part #	Mfg #	Model	Description	GPF	Spud	Price
14170	3010100	110	Water Saver	3.5	1-1/2"	133.75
14173	3010000	111	Low Consumption	1.6	1-1/2"	133.75
909029	3910168	111-1.28	Low Consumption	1.28	1-1/2"	133.75
14180	3012400	180	Conventional	3.5	1-1/4"	168.35

### Royal® Model 117 Exposed Service Sink Flushometers

- Exposed service sink flushometer, for use with top spud service sinks
- 1" IPS Screwdriver Bak-Chek™ angle stop
- Spud coupling & flange for 1-1/2" top spud



Part #	Mfg #	Model	Description	GPF	Spud	Price
14176	3010500	117	Standard	6.5	1-1/2"	143.33

### Royal® Model 120 Exposed Water Closet Flushometers

- Exposed water closet flushometer for floor mounted back spud bowls
- 1" IPS Screwdriver Bak-Chek™ angle stop
- Elbow flush connection, spud coupling & flange for 1-1/2" back spud



Part #	Mfg #	Model	Description	GPF	Spud	Price
14179	3010800	120-3.5	Water Saver	3.5	1-1/2"	145.47

Prices & specifications are subject to change.

You can check stock availability, pricing and place orders online at [www.MetPipe.com](http://www.MetPipe.com).



## Flush Valves

**SLOAN.**

Plumbing

### Royal® Model 186 Exposed Urinal Flushometers

- Exposed urinal flushometer, for 3/4" top spud urinals
- 3/4" IPS Screwdriver Bak-Chek™ angle stop
- Spud coupling & flange for 3/4" top spud

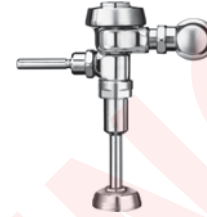

Part #	Mfg #	Model	Description	GPF	Spud	Price
14184	3012600	186	Water Saver	1.5	3/4"	133.75
14185	3012636	186-1	Low Consumption	1.0	3/4"	133.75
907006	3912697	186-0.5	Low Consumption	0.5	3/4"	133.75

### Regal® Diaphragm Type Exposed Flushometers

- ADA Compliant metal oscillating non-hold-open handle
- Vandal resistant stop cap
- Adjustable tailpiece
- Vacuum breaker flush connection
- Low consumption flush accuracy controlled by Para-Flo™ inside parts kit
- Handle packing, stop seat & vacuum breaker molded from PERMEX™ rubber compound for chloramine resistance
- Valve body, cover, tailpiece & control stop manufactured per ASTM alloy class for semi-red brass
- Valve in compliance with applicable sections of ASSE 1037, ANSI/ASME 112.19.6 & military specification V-29193

### Regal® 111 Exposed Water Closet Flushometers

- Exposed water closet flushometer, for floor mounted or wall hung top spud bowls
- 1" IPS Screwdriver Bak-Chek™ angle stop
- Spud coupling, wall & spud flanges for 1-1/2" top spud



Part #	Mfg #	Model	Description	GPF	Spud	Price
232756	3080000	111-1.6	Low Consumption	1.6	1-1/2"	107.77
170782	3080053	111-XL	Low Consumption*	1.6	1-1/2"	120.14

\* XL Variation includes ADA compliant handle, vandal resistant stop cap with set screw & sweat-solder adapter with cover tube & cast set screw wall flange

### Regal® 186 Exposed Urinal Flushometers

- Exposed urinal flushometer, for 3/4" top spud urinals
- 3/4" IPS Screwdriver Bak-Chek™ angle stop
- Spud coupling, wall & spud flanges for 3/4" top spud



Part #	Mfg #	Model	Description	GPF	Spud	Price
176462	3082653	186-XL	Water Saver*	1.5	3/4"	109.22
159585	3082675	186-1-XL	Water Saver*	1.0	3/4"	120.14

\* XL Variation includes ADA compliant handle, vandal resistant stop cap with set screw & sweat-solder adapter with cover tube & cast set screw wall flange

Prices & specifications are subject to change.



## Flush Valves



### Uppercut Dual-Flush Manual Flushometer - Handle Only Kit

- The UPPERCUT® is a manual dual-flush Flushometer that provides two water-efficient flush options DOWN for a regular 1.6 gpf flush or tilt the handle UP for reduced flush of 1.1 gpf. This award-winning product is available as a complete Flushometer or as a retrofit product for converting manual flush valves.
- Retrofits to most any existing valve
- Lifting Handle UP initiates reduced flush, eliminating liquid and paper waste
- Pushing Handle DOWN initiates full flush, eliminating solid waste and paper
- Reduces water volume by up to 30% when activated UPWARDS
- Antimicrobial Coating on Handle protects against germ transmission
- Distinctive Green Handle signifies Water Conserving Device
- Handle Packing molded from PERMEX™ Rubber Compound for
- Chloramine Resistance
- Includes (2) adhesive backed Metal Wall Plates etched w/Instructions



Plumbing

Part #	Mfg #	Model	Description	GPF	Spud	Price
865004	3372003	WES-212-A	Dual Flush Handle	1.6 / 1.1	-	56.84

## Sensor Operated Flushometers

### Royal Optima™ Sensor Operated Exposed Flushometers

- Dual filtered by-pass
- Optima® EL-1500-L self adaptive infrared sensor with indicator light
- Courtesy Flush™ override button
- Non-hold-open integral solenoid operator
- (2) Chrome plated wall cover plates (for 2-gang electrical box) with vandal resistant screws
- Free spinning vandal resistant stop cap
- Adjustable tailpiece
- High back pressure vacuum breaker flush connection with 1-piece bottom hex coupling nut
- Sweat solder adapter with cover tube & case set screw wall flange
- Valve body, cover, tailpiece & control stop manufactured per ASTM alloy class for semi-red brass
- Valve in compliance with applicable sections of ASSE 1037, ANSI/ASME 112.19.6 & military specification V-29193, ADA standards

### G2® OptimaPlus RESS Royal Retro Conversion Kits

- Battery powered, sensor operated G2® Model retrofit conversion kit for Sloan Royal®, Regal Pro® and Regal® flushometers
- Courtesy flush override button & user friendly 3-second flush delay
- Installation tools provided
- Chrome plated metal handle cap



Part #	Mfg #	Model	Description	Price
226471	3325400	RESS-G2-C	ADA 1.6 Closet Retrofit Kit, with (2) Flush Regulators	308.24
226469	3325402	RESS-G2-U	ADA 1.0 Optima Urinal Retrofit Kit, with (2) Flush Regulators	308.24



## Flush Valves

**SLOAN.**

### Royal Optima® Exposed Sensor Operated Water Closet Flushometers

- Exposed sensor operated water closet flushometer, for floor mounted or wall-hung back spud bowls
- 1" IPS Screwdriver Bak-Chek™ angle stop
- Spud coupling & flange for 1-1/2" top spud

**OPTIMA®**



Part #	Mfg #	Model	Description	GPF	Spud	Price
38253	3450047	111ES-S	Low Consumption	1.6	1-1/2"	441.05

### Royal Optima® Exposed Sensor Operated Urinal Flushometers

- Exposed sensor operated water closet flushometer, for floor mounted or wall-hung back spud bowls
- 3/4" IPS Screwdriver Bak-Chek™ angle stop
- Spud coupling & flange for 3/4" top spud

**OPTIMA®**

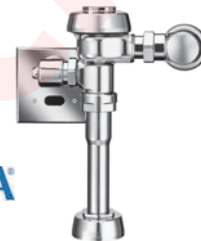

Part #	Mfg #	Model	Description	GPF	Spud	Price
36233	3452673	186-1ES-S	Low Consumption	1.0	3/4"	429.65

### G2 OptimaPlus® Battery Powered Exposed Water Closet Flushometers

- PERMEX™ synthetic rubber diaphragm with dual filtered fixed bypass designed for improved life & reduced maintenance
- ADA Compliant OptimaPlus® battery powered infrared sensor for automatic "No Hands" operation
- Infrared Sensor with multiple-focused, lobular sensing fields for high and low target detection
- Isolated latching solenoid operator, isolates magnetic components from water contact
- Engineered metal cover with replaceable lens window
- Courtesy Flush™ override button & user friendly 3-second flush delay
- Four (4) Size AA batteries factory installed & "Low Battery" flashing LED
- Infrared sensor range adjustment screw
- Initial set-up range indicator light (first 10 minutes)
- Free spinning, vandal resistant stop cap
- Adjustable tailpiece
- High back pressure vacuum breaker flush connection with 1-piece bottom hex coupling nut
- Sweat solder adapter with cover tube and cast set screw wall flange
- High copper, low zinc brass casting for dezincification resistance
- Fixed metering bypass and no external volume adjustment to ensure water conservation
- Flush accuracy controlled by CID™ Technology
- Diaphragm, stop seat and vacuum breaker to be molded from PERMEX™ rubber compound for chloramine resistance

### G2 OptimaPlus® Models 8110/8111 Exposed Water Closet Flushometers

- Exposed, battery powered, sensor operated water closet flushometer for floor mounted or wall hung top spud bowls
- 1" IPS Screwdriver Bak-Chek™ angle stop
- Spud coupling and flange for 1-1/2" top spud



**G2 OPTIMA plus**



Part #	Mfg #	Model	Description	GPF	Spud	Price
227432	3250400	8111	Water Saver	1.6	1-1/2"	402.87
924634	3250289	8111-1.28	Water Saver	1.28	1-1/2"	402.87

Prices & specifications are subject to change.





## Flush Valves

**SLOAN.**

### G2 OptimaPlus® Model 8186 Exposed Urinal Flushometers

- Exposed, battery powered, sensor operated urinal flushometer
- 3/4" IPS Screwdriver Bak-Chek™ angle stop
- Spud coupling and flange for 3/4" top spud
- Supplied less handle opening and metal cap



Plumbing

Part #	Mfg #	Model	Description	GPF	Spud	Price
227431	3250403	8186	Water Saver	1.5	3/4"	402.87
226473	3250401	8186-1	Water Saver	1.0	3/4"	402.87
908472	3250424	8186-0.5	Water Saver	0.5	3/4"	402.87

### Flush Valve Transformers

- Operates up to 10 water closet or urinal (any combination)
- 120 VAC Input, 50/60 Hz Primary
- 24 VAC Output, 50/60 Hz Secondary
- Class II, UL Listed
- 50 VA

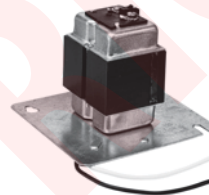

EL-154



EL-208

Part #	Mfg #	Model	Description	Price
36231	0345154	EL-154	120VAC/24VAC, 50/60Hz (50VA), Box-Mount	29.14
36245	0345211	EL-208	120VAC/24VAC, 50/60Hz (100VA), Foot-Mount	91.77

### Side-Mounted Flushometer Operator (with Metal Cover)

- Quiet, Exposed, OPTIMA®, Battery Powered, Sensor Operated Closet and Urinal Flushometer Retrofit Conversion Kit for Sloan Flushometers
- ADA Compliant OPTIMA® Battery Powered Infrared Sensor for automatic "No Hands" operation
- Chrome Plated Infrared Sensor Housing
- Angled Sensor Window
- Manual Override Flush Button
- Four (4) Size C Batteries included
- "Low Battery" Flashing LED with Optional Audio Tone
- "User in View" Flashing LED
- Optional 24 Hour Sentinel Flush
- Infrared Sensor Range Adjustment Screw and Reset Button
- Installation Tools provided
- No External Volume Adjustment to Ensure Water Conservation



Part #	Mfg #	Model	Description	Price
220333	0325105	EBV-89A-M	Side-Mount Operator	253.56

Prices & specifications are subject to change.

Our state of the art pipe shop offers cutting, threading, grooving and make-ons up to 36in!



## Flush Valves

**SLOAN.**

Plumbing

### Solar Powered Sensor Operated Flushometers

#### Sloan SOLIS® Exposed Solar-Powered Dual-Flush Water Closet Flushometers

- Sloan SOLIS® exposed, solar-powered, dual-flush water closet Flushometers, which are part of the Sloan SOLIS Collection, are the industry's first solar-powered, sensor-operated Flushometers.
- The dual-flush model has two flush cycles: Users can choose the full 1.6 gpf/6.0 Lpf flush for solid waste or the reduced flush of 1.1 gpf/4.2 Lpf for liquid waste.
- If the user does not press a button, the Flushometer's Dual-Flush Smart Sense Technology™ takes over and automatically initiates a flush cycle, based on how long the user remains in the sensor range.
- Four (4) Size AA Battery Back-up Power Source
- "Low Battery" Flashing LED
- Flex Tube Diaphragm designed for improved life and reduced maintenance
- ADA Compliant Sloan SOLIS® Electronic Dual Flush Solar Powered Infrared Sensor for automatic "No Hands" operation
- Infrared Sensor with Multiple-focused, Lobular Sensing Fields for high and low target detection
- Courtesy Flush™ Override Buttons for Full and Reduced Flush
- Infrared Sensor Range Adjustment Screw
- 1" I.P.S. Screwdriver Bak-Chek® Angle Stop
- Free Spinning, Vandal Resistant Stop Cap
- Adjustable Tailpiece



Part #	Mfg #	Model	Description	GPF	Spud	Price
906348	8111-1.6/11	8111-1.6/1.1	Solar Water Saver	1.6/1.1	1-1/2"	528.85
919416	8111-1.28	8111-1.28	Solar Water Saver	1.28	1-1/2"	556.69

- Four (4) Size AA Battery Back-up Power Source
- "Low Battery" Flashing LED
- Flex Tube Diaphragm designed for improved life and reduced maintenance
- ADA Compliant Sloan SOLIS® Electronic Dual Flush Solar Powered Infrared Sensor for automatic "No Hands" operation
- Infrared Sensor with Multiple-focused, Lobular Sensing Fields for high and low target detection
- Courtesy Flush™ Override Buttons for Full and Reduced Flush
- Infrared Sensor Range Adjustment Screw
- 3/4" I.P.S. Screwdriver Bak-Chek® Angle Stop
- Free Spinning, Vandal Resistant Stop Cap
- Adjustable Tailpiece



Part #	Mfg #	Model	Description	GPF	Spud	Price
913755	8186-0.5	8186-0.5	Solar Water Saver	0.5	3/4"	528.85
915866	8186-1.0	8186-1.0	Solar Water Saver	1.0	3/4"	502.40

Prices & specifications are subject to change.



## Flush Valves



### Slimline Bedpan Washer Flushometer

- For floor-mount or wall-hung top spud bowls
- Dual filtered by-pass
- Diaphragm, handle packing, stop seat & vacuum breaker molded from PERMEX™ rubber compound for chloramine resistance
- Metal oscillating non-hold-open handle w/triple seal handle packing
- Free spinning vandal-resistant stop cap
- Adjustable tailpiece
- High back pressure vacuum breaker flush connection with 1-piece bottom hex coupling nut
- Sweat solder adapter with cover tube and case set screw wall flange
- Diverter assembly with solid 1-piece body construction, solid brass spray arm, counter balanced pivot assembly, diverter valve wall support
- Valve body, cover, tailpiece and control stop manufactured per ASTM alloy class for semi-red brass
- Valve in compliance with applicable sections of ASSE 1037, ANSI/ASME 112.19.6 & military specification V-29193
- 1" IPS Screwdriver Bak-Chek™ angle stop
- Spud coupling & flange for 1-1/2" top spud



Part #	Mfg #	Model	Description	GPF	Spud	Price
53590	3019700	BPW-1000	Water Saver	3.5	1-1/2"	408.28

### Flushometer Sweat Solder Kits

Part #	Mfg #	Model	Description	Price
14199	3308788	H-636-AA	Sweat Solder Kit 3/4" w/Cast Set Screw Flange (YBYC)	7.12
14200	3308782	H-633-AA	Sweat Solder Kit 1" w/Cast Set Screw Flange (YBYC)	7.12
147181	3308780	H-533-AS	Sweat Solder Kit for 1" Supply Closet & Urinal	7.15

THE BOLD LOOK  
 OF **KOHLER**®

### Touchless DC Urinal Flushometers

#### Touchless DC Battery Powered Flushometer

- Solid metal construction for durability and reliability
- Fixture-mount design
- Includes four 1.5 V AA alkaline batteries
- Electronic infrared sensor with Tripoint™ technology for accurate activation
- Intended for toilet installations with 1-1/2" top spud coupling connection
- Piston valve technology offers reliable and accurate flushing performance across pressures
- Activation distance is factory set - no adjustments on-site
- Chloramine resistance on all rubber exposed to waterway
- Manual courtesy flush button (works without DC power)
- 24 hour sentinel flush operates automatically if unit not flushed for 24 hours
- Includes vacuum breaker and control stop



Retrofit Kit

Part #	Mfg #	Description	GPF	Spud	Price
886082	K10956-CP	Exposed Touchless DC Toilet Flushometer	1.28	1-1/2"	557.20
886084	K10957-CP	Exposed Touchless DC Toilet Flushometer	1.6	1-1/2"	420.29
886086	K10960-CP	Exposed Touchless DC Urinal Flushometer	1.0	1-1/2"	420.29

Prices & specifications are subject to change.

Metropolitan Pipe offers FREE DELIVERY in the Greater Boston area.



## Flush Valves

### Touchless DC Urinal Flushometers (Continued)

#### Touchless DC Battery Powered Flushometer

Part #	Mfg #	Description	GPF	Spud	Price
885994	K10962-CP	Retrofit Kit - Toilet	1.6	1-1/2"	374.66
886484	K10965-CP	Retrofit Kit - Urinal	1.0	1-1/2"	374.66

#### Wave™ Touchless DC Battery Powered Flushometers

- WAVE technology offers hygienic touchless operation on command. Activating only when a hand is waved directly over the flushometer, the sensor eliminates random flushing that can be frightening for children. And by removing false actuations, Wave technology provides even greater water savings.
- Manual override flushes even if the batteries have expired
- 24-hour sentinel flush keeps trapway fresh
- Waterproof shroud protects electronic components
- Serviceable without turning water supply off



Part #	Mfg #	Description	GPF	Spud	Price
923634	K10673-CP	Exposed Wave™ Touchless DC Toilet Flushometer	1.28	1-1/2"	363.57
930376	K10674-CP	Exposed Wave™ Touchless DC Toilet Flushometer	1.6	1-1/2"	363.57
930379	K10675-CP	Exposed Wave™ Touchless DC Urinal Flushometer	0.5	1-1/2"	363.57
930381	K10676-CP	Exposed Wave™ Touchless DC Urinal Flushometer	1.0	1-1/2"	363.57
930380	K10678-CP	Retrofit Kit - Urinal	0.5	1-1/2"	313.03



Low flow aerators, showerheads, low GPF toilets and flushometers, and more - ALL IN STOCK.

Visit our GREEN website:

<http://green.metpipe.com>



# Lavatories

THE BOLD LOOK  
OF **KOHLER**®

Plumbing

## Pedestal Lavatories

### Memoirs™ Fireclay Pedestal Lavatory

**K-2268 Combination:**

K-2269 Stately Lavatory  
 K-2267 Pedestal

**K-2258 Combination:**

K-2259 Classic Lavatory  
 K-2267 Pedestal

**K-2238 Combination:**

K-2239 Classic Lavatory  
 K-2267 Pedestal



THE BOLD LOOK  
OF **KOHLER**®

K-2268-8 Shown with Faucet K-2258-8 Shown with Faucet

Part #	Mfg #	Description	Dimensions	Holes	Color	Price
140429	K-2269-8-0	Stately Lavatory Basin	30" x 21-3/4"	8"	White	516.90
133871	K-2239-8-0	Classic Lavatory Basin	24" x 19-3/4"	8"	White	204.32
135185	K-2259-8-0	Classic Lavatory Basin	27" x 22"	8"	White	426.09
133872	K-2267-0	Pedestal Leg Only	26-1/8"	-	White	167.30

### Mansfield Barrett Pedestal Lavatory

- Classic styling with architectural details that is universally appealing
- 24-3/8" x 19-1/8" pedestal lavatory
- 34" luxury height
- Integral rear overflow
- Basin: 17-5/16" x 11-1/4"
- Outstanding Protection - The Mansfield limited lifetime warranty
- Meets or exceeds ANSI/ASME A112.19.2
- Meets or exceeds Canadian Standards Association CSA B45.3

*mansfield*



Part #	Mfg #	Description	Dimensions	Holes	Color	Price
937260	328-8	Barrett Pedestal Lav	24-3/8" x 19-1/8"	8in	White	109.95
937261	329	Pedestal Only				83.78

### Chablis™ Vitreous China Pedestal Lavatory

**K-2081 Combination:**

K-2138 Lavatory  
 K-2142 Pedestal

THE BOLD LOOK  
OF **KOHLER**®



K-2081 Shown with Faucet

Part #	Mfg #	Description	Dimensions	Holes	Color	Price
47981	K-2138-8-0	Lavatory Basin	24" x 19"	8"	White	205.45

Prices & specifications are subject to change.



## Lavatories

Plumbing

### Sacramento™ Pedestal Lavatory

- Grade A vitreous china
- 34" Height installed
- 5-Year limited warranty

442124 Combination  
 446124 Lavatory  
 448120 Pedestal

442128 Combination  
 446128 Lavatory  
 448120 Pedestal



Faucet Not Included

Part #	Mfg #	Description	Dimensions	Color	Price
241167	446124-0	4"cc Sacramento™ Lavatory Basin	21-1/4" x 18-1/4"	White	99.90
891439	446128-0	8"cc Sacramento™ Lavatory Basin	21-1/4" x 18-1/4"	White	93.96
891440	448120-0	Sacramento™ Pedestal Leg Only		White	76.75

### Southampton™ Deluxe Pedestal Lavatory

- Grade A vitreous china
- 33" Height installed
- 5-Year limited warranty

442428 Combination  
 446428 Lavatory  
 448420 Pedestal

442424 Combination  
 446424 Lavatory  
 448420 Pedestal



Faucet Not Included

Part #	Mfg #	Description	Dimensions	Color	Price
891436	448420-0	Southampton™ Pedestal Leg Only	-	White	88.69
891433	446424-0	4"cc Southampton™ Lavatory Basin	23-3/8" x 18-1/4"	White	108.45
891434	446428-0	8"cc Southampton™ Lavatory Basin	23-3/8" x 18-1/4"	White	108.45

### Portrait™ Vitreous China Pedestal Lavatory

**K-2221 Combination:**

K-2222 Lavatory  
 K-2223 Pedestal



K-2221-8 Shown with Faucet

Part #	Mfg #	Description	Dimensions	Holes	Color	Price
47374	K-2222-8-0	Lavatory Basin	27" x 19-3/8"	8"	White	338.70
47983	K-2223-0	Pedestal Leg Only			White	154.36



# Lavatories

THE BOLD LOOK  
 OF **KOHLER**®

Plumbing

## Cast Iron Countertop Lavatories

### Farmington™ Cast Iron Self-Rimming Countertop Lavatory

- With overflow

THE BOLD LOOK  
 OF **KOHLER**®



K-2905 Shown with Faucet

Part #	Mfg #	Description	Dimensions	Holes	Color	Price
13126	K-2905-4-0	ADA Lavatory Basin	19-1/4" x 16-1/4"	4"	White	114.07
13127	K-2905-8-0	ADA Lavatory Basin	19-1/4" x 16-1/4"	8"	White	114.07

## Vitreous China Countertop Lavatories

### Brookline™ Vitreous China Self-Rimming Countertop Lavatory

- Includes sealant

THE BOLD LOOK  
 OF **KOHLER**®



K-2202-4 Shown with Faucet

Part #	Mfg #	Description	Dimensions	Holes	Color	Price
13096	K-2202-4-0	ADA Lavatory Basin	19" Diameter	4"	White	87.89

### Pennington™ Vitreous China Self-Rimming Countertop Lavatory

- Includes sealant

THE BOLD LOOK  
 OF **KOHLER**®



K-2196-4 Shown with Faucet

Part #	Mfg #	Description	Dimensions	Holes	Color	Price
13093	K-2196-4-0	ADA Lavatory Basin	20-1/4" x 17-1/2"	4"	White	88.60
13094	K-2196-8-0	ADA Lavatory Basin	20-1/4" x 17-1/2"	8"	White	88.60

## Mansfield Maverick II Rimmed Lavatory

- Extra wide, tapered rim highlights the styling with form and function
- 20" x 17" oval, drop-in lavatory
- Concealed front overflow
- Basin: 15-1/2" x 10-31/2"
- Outstanding Protection - The Mansfield limited lifetime warranty
- Meets or exceeds ANSI/ASME A112.19.2
- Meets or exceeds Canadian Standards Association CSA B45.3

*mansfield*



Part #	Mfg #	Description	Dimensions	Holes	Color	Price
936644	267-4	Oval Drop-in Lav	20" x 17"	4in	White	40.41

Prices & specifications are subject to change.

Our faucet parts counter is one of the largest in the Boston area with thousands of parts in stock!



## Lavatories

### Vitreous China Countertop Lavatories (Continued) Mansfield Maverick II Rimmed Lavatory

Part #	Mfg #	Description	Dimensions	Holes	Color	Price
936645	267-8	Oval Drop-in Lav	20" x 17"	8in	White	40.41

### Sanibel™ Self-Rimming Lavatory

- Inconspicuous soap depressions
- 5-Year limited warranty



Part #	Mfg #	Description	Drain	Size/Shape	Color	Price
236890	442004-0	Sanibel	4"	20" x 17" Oval	White	84.18
891432	442008-0	Sanibel	8"	20" x 17" Oval	White	84.18

### Portrait™ Vitreous China Self-Rimming Countertop Lavatory

- Includes sealant



K-2189-8 Shown with Faucet

Part #	Mfg #	Description	Dimensions	Holes	Color	Price
13092	K-2189-8-0	ADA Lavatory Basin	22-5/8" x 18-7/8"	8"	White	205.45

### Vitreous China Undercounter Lavatories

ADA - Compliant when installed according to the requirements of the Accessibility Guidelines, Section 606 Lavatories and Mirrors, of the Act

### Caxton™ Vitreous China Undercounter Lavatory

- With 52047 clamp assembly
- Includes sealed overflow
- Unglazed underside



K-2211 Shown Installed

Part #	Mfg #	Description	Dimensions	Holes	Color	Price
47817	K-2209-0	ADA Lavatory Basin	15" x 12"	Less Holes	White	77.39
13098	K-2210-0	ADA Lavatory Basin	17" x 14"	Less Holes	White	71.26
50613	K-2210-96	ADA Lavatory Basin	17" x 14"	Less Holes	Biscuit	92.59
13099	K-2211-0	ADA Lavatory Basin	19" x 15"	Less Holes	White	77.50





# Lavatories

THE BOLD LOOK  
 OF **KOHLER**®

Plumbing

## Maple Undercounter Lavatory

- Oval design
- 19-1/2" x 16-1/8" outside dimension
- 17" x 14" inside dimension
- Under counter installation
- Concealed front overflow
- Outstanding Protection - The Mansfield limited lifetime warranty
- Meets or exceeds ANSI/ASME A112.19.2
- Meets or exceeds Canadian Standards Association CSA B45.0



Part #	Mfg #	Description	Dimensions	Holes	Color	Price
936647	217NS	Oval Undercounter Lav	19-1/2" x 16-1/8" (Outside)	-	White	36.29

## Cast Iron Undercounter Lavatories Thoreau™ Cast Iron Undercounter Lavatory



K-907-8U Shown Installed

Part #	Mfg #	Description	Dimensions	Holes	Color	Price
177116	K-2907-8U-96	ADA Lavatory Basin	19-1/4" x 16-1/4"	8"	Biscuit	452.90

## Vitreous China Wall-Mount Lavatories

ADA - Compliant when installed according to the requirements of the Accessibility Guidelines, Section 606 Lavatories and Mirrors, of the Act

### Chesapeake™ Vitreous China Wall-Mount Lavatory

- Ledge-back with hanger
- Includes overflow
- Drilled for concealed arm carrier



Shown with Faucet

Part #	Mfg #	Description	Dimensions	Holes	Color	Price
191123	K-1724-0	ADA Lavatory Basin	19-1/4" x 17-1/4"	8"	White	66.09
173651	K-1723-0	ADA Lavatory Basin	20" x 18-1/4"	8"	White	66.09

### Soho™ Vitreous China Wall-Mount Lavatory

- Includes overflow
- Drilled for concealed arm carrier



K-2053-7 Shown with Faucet



K-2084 Shown with Faucet

Part #	Mfg #	Description	Dimensions	Holes	Color	Price
13074	K-2053-0	ADA Lavatory Basin	20" x 18"	8"	White	133.00

Prices & specifications are subject to change.

Our office hours are 7am to 4:30pm and counter hours 6am to 4:30pm Monday through Friday.



## Lavatories

### Vitreous China Wall-Mount Lavatories (Continued)

#### Soho™ Vitreous China Wall-Mount Lavatory

Part #	Mfg #	Description	Dimensions	Holes	Color	Price
180167	K-2084-0	ADA Lavatory Basin	20" x 18"	Single-Hole	White	133.00

#### Willow Run Wall Mount Lavatory

- 19-1/2" x 16-3/4" wall-mount lavatory
- Ledge back design aids in preventing water damage
- Twin soap recesses for added functionality
- Drilled for concealed arm carrier
- Concealed front overflow
- Includes hanger
- Basin: 13-1/2" x 10"
- 4" faucet center
- Outstanding protection - The Mansfield limited lifetime warranty
- Meets or exceeds ANSI/ASME A112.19.2 and ANSI A117.1
- Meets or exceeds Canadian Standards Association CSA B45.0



Part #	Mfg #	Description	Dimensions	Holes	Color	Price
182571	1917C	Willow Run Wall Mount Lav	19-1/2" x 16-3/4"	4in	White	39.59

#### Walnut Knoll Wall Mount Lavatory

- 21" x 18-3/4" wall-mount lavatory
- Wide back ledge for optimum functionality
- Drilled for concealed arm carrier
- Concealed front overflow
- Includes hanger
- Basin: 13-1/2" x 10"
- Outstanding Protection - The Mansfield® limited lifetime warranty
- Meets or exceeds ANSI/ASME A112.19.2 and ANSI A117.1
- Meets or exceeds Canadian Standards Association CSA B45.0
- Complies with ADA requirements for accessibility



Part #	Mfg #	Description	Dimensions	Holes	Color	Price
936657	2008-4	ADA Walnut Knoll Wall Mount Lav	21" x 18-3/4"	4in	White	43.71
936658	2008-8	ADA Walnut Knoll Wall Mount Lav	21" x 18-3/4"	8in	White	43.71



## Lavatories

THE BOLD LOOK  
 OF **KOHLER**®

Plumbing

### Grande Isle Wall Mount Lavatory

- High-back, 22" x 18-1/8" wall-mount lavatory
- Full, 4" high back splash
- Drilled for concealed arm carrier
- Concealed front overflow Includes hanger
- Basin: 16" x 10-5/8"
- Outstanding Protection - The Mansfield limited lifetime warranty
- Meets or exceeds ANSI/ASME A112.19.2 and ANSI A117.1
- Meets or exceeds Canadian Standards Association CSA B45.0
- Complies with ADA requirements for accessibility

*mansfield* 



Part #	Mfg #	Description	Dimensions	Holes	Color	Price
227248	2018-4HBNS	ADA Grande Isle Wall Mount Lav	22" x 18-1/8"	4in	White	49.48
936662	2018-8HBNS	ADA Grande Isle Wall Mount Lav	22" x 18-1/8"	8in	White	49.48

### Chesapeake™ Vitreous China Wall-Mount Lavatory

- Ledge-back with hanger
- Drilled for concealed arm carrier

THE BOLD LOOK  
 OF **KOHLER** 



K-1728 Shown with Faucet

Part #	Mfg #	Description	Dimensions	Holes	Color	Price
13056	K-1728-0	ADA Lavatory Basin	19-1/4" x 17-1/4"	4"	White	66.09
13057	K-1729-0	ADA Lavatory Basin	20" x 18-1/4"	4"	White	66.09

### Greenwich™ Vitreous China Wall-Mount Lavatory

- With back & wall hanger
- Drilled for concealed arm carrier

THE BOLD LOOK  
 OF **KOHLER** 



K-2032-1 Shown with Faucet

Part #	Mfg #	Description	Dimensions	Holes	Color	Price
13063	K-2023-0	Lavatory Basin	18-5/8" x 16"	8"	White	83.60
13068	K-2027-0	Lavatory Basin	18-5/8" x 16"	4"	White	108.50
13064	K-2030-0	ADA Lavatory Basin	20-3/4" x 18-1/4"	8"	White	74.07
13069	K-2032-0	ADA Lavatory Basin	20-3/4" x 18-1/4"	4"	White	74.07

### Kingston™ Vitreous China Wall-Mount Lavatory

- With back & wall hanger
- Drilled for concealed arm carrier

THE BOLD LOOK  
 OF **KOHLER** 



K-2006-8 Shown with Faucet

Part #	Mfg #	Description	Dimensions	Holes	Color	Price
13061	K-2005-0	ADA Lavatory Basin	21-1/4" x 18-1/8"	4"	White	73.07

Prices & specifications are subject to change.

You can check stock availability, pricing and place orders online at [www.MetPipe.com](http://www.MetPipe.com).



## Lavatories

### Vitreous China Wall-Mount Lavatories (Continued)

#### Kingston™ Vitreous China Wall-Mount Lavatory

Part #	Mfg #	Description	Dimensions	Holes	Color	Price
13062	K-2006-0	ADA Lavatory Basin	21-1/4" x 18-1/8"	8"	White	73.07
49947	K-2007-0	ADA Lavatory Basin	21-1/4" x 18-1/8"	Single-Hole	White	124.55

#### Soho™ Vitreous China Wall-Mount Lavatory

- Drilled for concealed arm carrier

THE BOLD LOOK  
 OF **KOHLER**®



K-2054-1 Shown with Faucet

Part #	Mfg #	Description	Dimensions	Holes	Color	Price
13076	K-2054-0	ADA Lavatory Basin	20" x 18"	4"	White	133.00

#### Morningside™ Wheelchair Vitreous China Wall-Mount Lavatory

- Drilled for concealed arm carrier

THE BOLD LOOK  
 OF **KOHLER**®



K-12638 Shown with Faucet

Part #	Mfg #	Description	Dimensions	Holes	Color	Price
13269	K-12634-0	Lavatory Basin	20" x 27"	11-1/2"	White	238.57
13271	K-12636-0	Lavatory Basin	20" x 27"	4"	White	238.57

#### Wheelchair Wall Mounted Lavatory

- 27" x 20" wall-mount lavatory
- Concave front for wheelchair accessibility
- Drilled for concealed arm carrier
- Concealed front overflow
- Basin: 13-1/4" x 12-3/4"
- Outstanding Protection - The Mansfield limited lifetime warranty
- Meets or exceeds ANSI/ASME A112.19.2 and ANSI A117.1
- Meets or exceeds Canadian Standards Association CSA B45.0
- Complies with ADA requirements for accessibility

**mansfield**®



Part #	Mfg #	Description	Dimensions	Holes	Color	Price
936663	315-4	ADA Wheelchair Lav	27" x 20"	4in	White	161.62
132342	315-8	ADA Wheelchair Lav	27" x 20"	8in	White	161.62



## Lavatories

THE BOLD LOOK  
OF **KOHLER**®

### Pamlico Shroud Wall Mounted Lavatory

- Perfect for clinical applications
- 21-1/4" x 22"
- Clean lines for easier cleaning
- ADA Compliant
- Outstanding protection — The Mansfield® limited lifetime warranty



Plumbing

Part #	Mfg #	Description	Dimensions	Holes	Color	Price
937262	2038-4	ADA Pamlico Lav	21-1/4" x 22"	4in	White	102.60
937263	2039	Shroud				68.40

### Cast Iron Wall Mount Lavatories Trailer™ Cast Iron Wall-Mount Lavatory

- Includes overflow
- 3" Shelf-back
- Factory installed K-8046-2A Triton® faucet with grid drain & aerator

THE BOLD LOOK  
OF **KOHLER**®



Part #	Mfg #	Description	Dimensions	Color	Price
13112	K-2753-0	Lavatory Basin with Faucet	13" x 13"	White	434.90

### Hampton™ Cast Iron Wall-Mount Lavatory

- With factory installed K-8040-2A Triton faucet
- With overflow

THE BOLD LOOK  
OF **KOHLER**®



Part #	Mfg #	Description	Dimensions	Holes	Color	Price
13109	K-2705-0	Lavatory Basin	19" x 17"	5-1/2"	White	686.55

### Hudson™ Cast Iron Wall-Mount Lavatory

- With overflow
- Optional soap dispenser hole on left (-L) or right (-R)

THE BOLD LOOK  
OF **KOHLER**®



K-2861 Shown with Faucet

Part #	Mfg #	Description	Dimensions	Holes	Color	Price
13115	K-2861-0	ADA Lavatory Basin	19" x 17"	4"	White	203.26
13117	K-2863-0	ADA Lavatory Basin	19" x 17"	8"	White	346.45

### Marston™ Cast Iron Wall-Mount Lavatory

- Shelf-back corner lavatory
- With factory installed K-8042-2A Triton faucet with pop-up drain and aerator

THE BOLD LOOK  
OF **KOHLER**®



K-2766 Shown with Faucet

Part #	Mfg #	Description	Dimensions	Holes	Color	Price
13113	K-2766-0	Lavatory Basin	16" x 16"	Less Holes	White	494.71

Prices & specifications are subject to change.

We offer a variety of GREEN products such as flush valves, faucets, showerheads & more!



## Lavatories

### Vitreous China Institutional Service Sinks

#### Camerton™ Service Sink - Vitreous China

- 21-1/2"L x 25"W
- No faucet holes
- Constructed of vitreous china



Shown with rim guard - not included

Part #	Mfg #	Description	Dimensions	Holes	Color	Price
13275	K-12867-0	Kohler Service Sink	21-1/2" x 25"	1-1/2" Top Spud	White	746.71
936664	3072	Mansfield Service Sink	21-1/2" x 25"	1-1/2" Top Spud	White	718.06

#### Hollister™ Utility Sink - Vitreous China

- Single center hole drilled back ledge
- Constructed of vitreous china



Part #	Mfg #	Description	Dimensions	Holes	Color	Price
13274	K-12793-0	Utility Sink	28" x 22"	Single	White	1137.05
41559	K-12794-0	Utility Sink	28" x 22"	3	White	1137.05

#### Gilford™ Scrub-up/Plaster Sink - Vitreous China

- Single center hole drilled back
- Constructed of vitreous china



Part #	Mfg #	Description	Dimensions	Holes	Color	Price
13272	K-12784-0	Scrub-up/Plaster Sink	24" x 22-1/8"	Single	White	933.50
76781	K-12781-0	Scrub-up/Plaster Sink	30" x 22"	Single	White	776.15
51910	K-12787-0	Scrub-up/Plaster Sink	30" x 22"	8"	White	776.15

#### Tyrrell™ Service Sink - Vitreous China

- Rim holes provide a uniform cascade of water to keep sides of sink clean
- Siphon jet provides a powerful surge of water to effectively eliminate maximum debris or waste
- 2-1/2" trap way larger than most residential toilet trap ways
- Large basin allows placement of more volume
- Crafted of vitreous china to provide a durable, nonporous product with a hard, glossy finish
- 1-1/2" top spud



Part #	Mfg #	Description	Dimensions	Holes	Color	Price
13257	K-6676-0	Service Sink	21" x 27-1/8"	1-1/2" Top Spud	White	716.85



## Lavatories

THE BOLD LOOK  
OF **KOHLER**®

### Sudbury™ Service Sink - Vitreous China

- 22"L x 20"W
- Back drilled

THE BOLD LOOK  
OF **KOHLER**®



Plumbing

Part #	Mfg #	Description	Dimensions	Holes	Color	Price
13253	K-6650-0	Service Sink	22" x 20"	8"	White	352.03
13254	K-6652-0	Service Sink	22" x 20"	Less Holes	White	600.05

### Cast Iron Institutional Sinks

#### Whitby™ Service Sink - Cast Iron

- 28"L x 28"W
- No faucet holes
- Constructed of KOHLER® Cast Iron

THE BOLD LOOK  
OF **KOHLER**®



Part #	Mfg #	Description	Dimensions	Holes	Color	Price
13260	K-6710-0	Service Sink	28" x 28"	Less Holes	White	659.36

#### Bannon™ Service Sink - Cast Iron

- 22-1/4"L x 18-1/4"W
- Back drilled on 8" centers
- Constructed KOHLER® Cast Iron
- Includes rim guard for added durability

THE BOLD LOOK  
OF **KOHLER**®



Part #	Mfg #	Description	Dimensions	Holes	Color	Price
13261	K-6714-0	Service Sink	22-1/4" x 18-1/4"	8"	White	479.63
13262	K-6716-0	Service Sink	24" x 20-1/4"	8"	White	539.62
13264	K-6718-0	Service Sink	22-1/4" x 18-1/4"	Less Holes	White	479.63
13265	K-6719-0	Service Sink	24" x 20-1/4"	Less Holes	White	539.62

#### Standard Traps for Service Sinks

Part #	Mfg #	Description	Price
13255	K-6672-NA	Kohler Adjustable trap standard for 2" iron pipe connection, with clean out plug & strainer	169.87
196100	T00-002	Jones Stephens Adjustable trap standard for 2" iron pipe connection, with clean out plug & strainer	173.30
13256	K-6673-NA	Kohler Adjustable trap standard for 3" iron pipe connection, with clean out plug & strainer	169.87
209631	T00-003	Jones Stephens Adjustable trap standard for 3" iron pipe connection, with clean out plug & strainer	173.30

Prices & specifications are subject to change.

Our state of the art pipe shop offers cutting, threading, grooving and make-ons up to 36in!



## Lavatories

### Brockway™ Wash Sink - Cast Iron

- The Brockway wash sink offers a classic look with the durability of KOHLER Cast Iron.

THE BOLD LOOK  
 OF **KOHLER**®



Plumbing

Part #	Mfg #	Description	Dimensions	Holes	Color	Price
83518	K-3200-0	Wash Sink	3'	2 Faucet, 1 Soap Dish	White	1409.90
83519	K-3202-0	Wash Sink	4'	2 Faucet, 1 Soap Dish	White	2116.75
41996	K-3203-0	Wash Sink	5'	3 Faucet, 2 Soap Dish	White	2512.90
83520	K-3204-0	Wash Sink	6'	3 Faucet, 2 Soap Dish	White	2778.45



### Durastone® Laundry Tubs

#### 18F & 18W Utilatub® Durastone® Laundry Tubs

- 18 Gallon capacity, 13" deep
- Sturdy, 1-piece, extra deep molded tub
- Made with DURASTONE® — combination of fiberglass and crushed stone blended with special resins for extra strength and durability, marbled white
- Leak proof, integrally molded-in drain with stopper
- Hooks up to standard 1-1/2" P- or S-trap
- Accommodates single or dual-handle faucets with 4" or 8" centers
- Floor model includes adjustable leg levelers
- Wall model includes wall mounting bracket, side supports and hardware for securing tub to concrete or stud wall
- Smooth surface, rust resistant

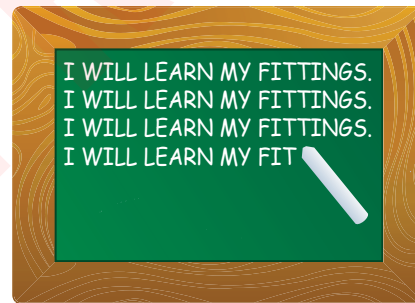

## Product Training

*Met Pipe offers training on every product we sell- from pumps to boilers. Let us organize a group training session for your team today!*

Part #	Mfg #	Size	Mounting	Price
171336	18F	20" x 24"	Floor	86.30
171337	18W	20" x 24"	Wall	86.30





## Laundry Tubs & Basins



### 26F & 26W Utilatwin® Durastone® Laundry Tubs

- 18 Gallon capacity per tub, 13" deep
- Sturdy, 1-piece, extra deep molded tub
- Made with DURASTONE® — combination of fiberglass and crushed stone blended with special resins for extra strength and durability, marbled white
- Includes twin drain waste connector — joins drain assemblies, assures rapid and uniform discharge of waste water, washers, slip nuts and stoppers provided
- Hooks up to standard 1-1/2" P- or S-trap
- Accommodates single or dual-handle faucet with 4" or 8" centers
- Floor model includes adjustable leg levelers
- Wall model includes wall mounting bracket, side supports and hardware for securing tub to concrete or stud wall
- Smooth surface, rust resistant



Part #	Mfg #	Size	Mounting	Price
171341	26F	40" x 24"	Floor	190.56

### Durastone® Mop Basins

- 1-Piece white molded construction
- Integrally molded drain with seal
- 65M Has elevated shelf
- Meets or exceeds ANSI specifications Z124.2 & 124.6

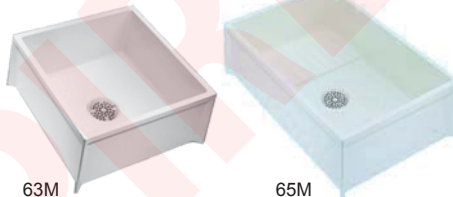

Part #	Mfg #	Size	IPS	Price
171343	63M	24" x 24" x 10"	3"	211.28
171342	65M	24" x 36" x 10"	3"	227.52

### Mop Basin Accessories



Part #	Mfg #	Description	Price
177999	63.401	Bumper Guard 20-3/4" Length Fits 63M	9.63
171345	65.308	2" Drain Seal for 63M	9.65
185431	65.311	3" Jiffy Joint No-Hub	9.65
180852	65.403	Bumper Guard 32-3/4" Length Fits 65M	11.10
171339	65.600	Mop Hanger	57.22
171338	65.700	Hose & Hose Holder	34.07

### Duraguard™ Wall Guard

- Protects wall surfaces 12" height  
 20 gauge, #304 stainless steel

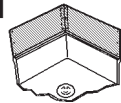

Part #	Mfg #	Size	Price
171344	67.2424	24" x 24"	164.84
180795	67.2436	24" x 36"	164.84







# Toilets & Urinals

Plumbing

## Kohler Toilet Reference Sheet

Combo Model Number	Bowl	Tank	Product Name	GPE	ADA	Bowl Shape	Flush	Rough	Dimensions
<b>K-3489</b>			Cinarron	1.6	Y	Elongated	Single	12"	29-5/16" L x 17-5/8" W x 28-3/4" H
<b>K-3615</b>			Gabriele	1.6	Y	Comp. Elong	Single	12"	28-1/4" L x 18-1/2" W x 28" H
<b>K-3324</b>			Kathryn (Concealed)	1.6	Y	Comp. Elong	Single	12"	27-3/4" L x 17-1/2" W x 28-1/4" H
<b>K-3812</b>			Memoirs w/Classic Design	1.6	Y	Comp. Elong	Single	12"	28-1/8" L x 17-3/4" W x 28-5/8" H
<b>K-3813</b>			Memoirs w/Stately Design	1.6	Y	Comp. Elong	Single	12"	28-1/8" L x 18-1/4" W x 28-1/2" H
<b>K-3386</b>			Rialto	1.6		Round-Front	Single	12"	25-1/4" L x 21-1/8" W x 22-3/4" H
<b>K-3607</b>			San Raphael w/C3 bidet seat	1.4/1.0	Y	Elongated	Power Lite	12"	30" L x 19-1/2" W x 21-1/2" H
<b>K-3466</b>			San Raphael (Concealed trap)	1.6		Elongated	Single	12"	29" L x 20-3/8" W x 23-1/4" H
<b>K-3323</b>			Santa Rosa	1.6		Comp. Elong	Single	12"	27-1/2" L x 18-3/4" W x 26-3/4" H
<b>Two-Piece Toilets</b>	<b>Bowl</b>	<b>Tank</b>	<b>Product Name</b>	<b>GPE</b>	<b>ADA</b>	<b>Bowl Shape</b>	<b>Flush</b>	<b>Rough</b>	<b>Dimensions</b>
<b>K-3551</b>	K-4356	K-4431	Archer	1.28	Y	Elongated	Single	12"	29" L x 17-7/8" W x 30" H
<b>K-3554</b>	K-4327	K-4645	Barrington (rear outlet)	1.6		Elongated	Pressure Lite	4"	28-3/4" L x 21-1/4" W x 29-1/4" H
<b>K-3887</b>	K-4347	K-4166	Cinarron	1.28	Y	Round-Front	Single	12"	27-1/4" L x 17-5/8" W x 30-1/2" H
<b>K-3589</b>	K-4309	K-4418	Cinarron	1.6	Y	Elongated	Single	12"	28-3/4" L x 17-5/8" W x 30-3/4" H
<b>K-3857</b>	K-4397	K-4438	Devonshire	1.28	Y	Elongated	Single	12"	29-1/4" L x 17-1/4" W x 30-3/4" H
<b>K-3979</b>	K-4199	K-4468	Highline Classic	1.6	Y	Elongated	Single	12"	29-3/4" L x 18" W x 31-1/4" H
<b>K-3493</b>	K-4304	K-4645	Highline Classic	1.6	Y	Elongated	Pressure Lite	12"	30-1/8" L x 21-1/4" W x 31-1/4" H
<b>K-3979</b>	K-4199	K-4468	Highline Comfort Height	1.6	Y	Elongated	Single	12"	29-3/4" L x 18" W x 31-1/4" H
<b>K-3999</b>	K-4199	K-4467	Highline Comfort Height	1.28	Y	Elongated	Single	12"	29-3/4" L x 18" W x 31-1/4" H
<b>K-3849</b>	K-4199	K-4841	Highline Comfort Height	1.28	Y	Elongated	Single	14"	TBD
<b>K-3889</b>	K-4373	K-4467	Highline Comfort Height	1.28	Y	Elongated	Single	10"	29-1/2" L x 18" W x 31-1/4" H
<b>K-3816</b>	K-4294	K-4491	Memoirs w/Classic Design	1.28	Y	Elongated	Single	12"	30-3/8" L x 17-1/3/16" W x 31-7/16" H
<b>K-3509</b>	K-4289	K-4491	Memoirs w/Classic Design	1.6/1.28	Y	Round-Front	Single	12"	28-3/8" L x 17-13/16" W x 31-1/2" H
<b>K-3526</b> (Discontinued)	K-4380	K-4434	Memoirs w/Stately Design	1.6	Y	Elongated	Single	12"	30-3/8" L x 18-7/8" W x 31-1/8" H
<b>K-3511</b>	K-4289	K-4492	Memoirs w/Stately Design	1.6/1.28	Y	Round-Front	Single	12"	28-3/8" L x 18-7/8" W x 31-1/8" H
<b>K-3654</b>	K-4322	K-4419	Persuade (Skirted)	1.6/0.8		Elongated	Dual	12"	27-5/8" L x 14-3/16" W x 31-1/2" H
<b>K-3591</b>	K-4317	K-4607	Portrait	1.6		Elongated	Single	12"	30" L x 20-7/16" W x 32-5/8" H
<b>K-3978</b>	K-4198	K-4468	Wellworth	1.6		Elongated	Single	12"	30" L x 18" W x 29-1/4" H
<b>K-3977</b>	K-4197	K-4468	Wellworth	1.6		Round-Front	Single	12"	28-1/2" L x 18" W x 29-1/4" H
<b>K-3948</b>	K-4293	K-4621	Wellworth	1.6		Elongated	Single	14"	31-5/8" L x 18-1/4" W x 28-3/4" H
<b>K-3889</b>	K-4373	K-4467	Wellworth	1.6		Elongated	Single	10"	29-1/2" L x 18" W x 31-1/4" H

Prices & specifications are subject to change.

Metropolitan Pipe offers Vendor Managed Inventory - never run out of that part again!



## Toilets & Urinals

Plumbing

### One-Piece 1.6 Residential Toilets

#### Rialto™ 1-Piece Residential 1.6 Toilet

- 25-1/4"L x 21-1/8"W x 22-3/4"H
- 14-7/8" High bowl
- Rim jet flushing system
- Includes K-4663 French Curve™ seat & cover
- EPDM Flapper

THE BOLD LOOK  
 OF **KOHLER**®



K-3386-0 Shown with Seat

Part #	Mfg #	Description	Rough-In	Color	Price
55274	K-3386-0	Round Complete, CP Trip, Less Supply	12"	White	384.56

### San Raphael™ 1-Piece Residential 1.6 Toilet Concealed Trapway

- 29"L x 20-3/8"W x 23-1/4"H
- 15" High bowl
- Ingenium® flushing system & brass supply shank
- Includes K-4713 French Curve™ Quiet-Close™ seat & cover
- EPDM Flapper

THE BOLD LOOK  
 OF **KOHLER**®



K-3466-0 Shown with Seat

Part #	Mfg #	Description	Rough-In	Color	Price
212832	K-3466-0	Elongated Complete, Trapway, CP Trip, Less Supply	12"	White	678.78

### Santa Rosa™ 1-Piece Compact Residential 1.6 Toilet

- 27-1/2"L x 18-3/4"W x 26-3/4"H
- 15" High bowl
- Gravity-fed siphon jet
- Ingenium® flushing system
- Includes K-4664 Brevia™ seat & cover
- EPDM Flapper

THE BOLD LOOK  
 OF **KOHLER**®



K-3323-0 Shown with Seat

Part #	Mfg #	Description	Rough-In	Color	Price
194702	K-3323-0	Elongated Complete, LH CP Trip, Less Supply	12"	White	336.44

### Two-Piece Toilets

#### Devonshire™ 2-Piece Residential 1.6 Toilet

- 30-7/8"L x 18-1/4"W x 31-1/2"H
- 15" High bowl
- Ingenium™ flushing system
- 2" Glazed trapway
- Less seat

THE BOLD LOOK  
 OF **KOHLER**®



K-3457 Shown with Seat

Part #	Mfg #	Description	Rough-In	Color	Price
191249	K-3457-0	Complete	12"	White	248.18
197361	K-4269-0	Elongated Bowl, Less Supply	12"	White	119.15
197360	K-4619-0	Classic Tank, LH CP Trip	-	White	131.64

Prices & specifications are subject to change.



## Toilets & Urinals

THE BOLD LOOK  
OF **KOHLER**®

### Memoirs® Comfort Height® - Stately Design Toilets

- Following the tradition of elegant architecture, this Memoirs toilet with Stately design merges performance and style. Its round-front seat conveniently fits smaller bath and powder rooms, and is positioned at a comfortable height for ease of use. High-powered flushing ensures cleanliness.
- Round: 28-3/8"L x 18-7/8"W x 31-1/8"H  
 Elongated: 30-3/8"L x 18-7/8"W x 31-1/8"H
- This performance-enhanced, two-piece toilet integrates with the Memoirs Suite
- Class Five® flushing technology
- Two-piece toilet
- Round-front bowl
- 12" rough-in
- Includes Polished Chrome trip lever, less supply



THE BOLD LOOK  
OF **KOHLER**®

#### 1.28 GPF - Round - 12in Rough

Part #	Mfg #	Description	Rough-In	Color	Price
892630	K-3511-0	Complete, Bowl & Tank	12"	White	287.54
945880	K-4434-0	1.28 GPF Tank	-	White	172.76
888935	K-4289-0	Round-front Bowl	12"	White	114.78

#### 1.28 GPF - Elongated - 12in Rough

Part #	Mfg #	Description	Rough-In	Color	Price
879611	K-3526-0	Complete, Bowl & Tank	12"	White	327.79
945880	K-4434-0	1.28 GPF Tank	-	White	172.76
945881	K-4380-0	Elongated Bowl	12"	White	155.03

### Memoirs® Comfort Height® - Classic Design Toilets

- With a design inspired by elegant architecture, this Memoirs toilet with Classic design merges performance and traditional style. Its round-front seat conveniently fits smaller bath and powder rooms, and is positioned at a comfortable height for ease of use. High-powered flushing ensures cleanliness.
- Round: 28-3/8"L x 17-13/16"W x 31-1/2"H  
 Elongated: 30-3/8"L x 17-13/16"W x 31-7/16"H
- This performance-enhanced, two-piece toilet integrates with the Memoirs Suite
- Class Five® flushing technology
- Two-piece toilet
- Round-front bowl
- 12" rough-in
- Includes Polished Chrome trip lever, less supply



THE BOLD LOOK  
OF **KOHLER**®

#### 1.28 GPF - Round - 12in Rough

Part #	Mfg #	Description	Rough-In	Color	Price
888936	K-3509-0	Complete, Bowl & Tank	12"	White	279.71
879616	K-4491-0	1.28 GPF Tank	-	White	164.93
888935	K-4289-0	Round-front Bowl	12"	White	114.78

#### 1.28 GPF - Elongated - 12in Rough

Part #	Mfg #	Description	Rough-In	Color	Price
949739	K-3816-0	Complete, Bowl & Tank	12"	White	319.96

Prices & specifications are subject to change.

Our faucet parts counter is one of the largest in the Boston area with thousands of parts in stock!



## Toilets & Urinals

### Two-Piece Toilets (Continued) Memoirs® Comfort Height® - Classic Design Toilets 1.28 GPF - Elongated - 12in Rough

Part #	Mfg #	Description	Rough-In	Color	Price
949738	K-4433-0	1.28 GPF Tank	-	White	164.93
945881	K-4380-0	Elongated Bowl	12"	White	155.03

### Mansfield Barrett Suite 2-Piece Residential Toilet

- Traditional styling
- Concealed trapway for easier cleaning
- Elongated front, SmartHeight™ (16-1/4" high bowl)
- Chair height for maximum comfort
- High performance MagnaFlush II™ flushing system with 3" flush valve virtually eliminates clogging
- Fill valve: Pilot operated, anti-siphon
- Water usage: 1.6 gpf / 6.0 lpf
- Meets or exceeds ANSI/ASME A112.192
- Meets or exceeds Canadian Standards Association CSA B45.0
- Outstanding protection – The Mansfield® limited lifetime warranty
- Complies with ADA requirements for accessibility

*mansfield*



Part #	Mfg #	Description	Rough-In	Color	Price
938211	115-106	Complete	12"	White	251.79
937258	115	Bowl	12"	White	158.59
937259	106	Tank - White	-	White	93.20

### Portrait™ 2-Piece Residential 1.6 Toilet

- 30"L x 20-7/16"W x 32-5/8"H
- 14-3/4" High bowl
- Ingenium™ flushing system
- 2" Glazed trapway
- Less seat

THE BOLD LOOK  
 OF **KOHLER**®



K-3591 Shown with Seat

Part #	Mfg #	Description	Rough-In	Color	Price
159048	K-3591-0	Complete	12"	White	427.93
159045	K-4317-0	Elongated Bowl, Less Supply	12"	White	171.25
159046	K-4607-0	Traditional Tank, LH CP Trip	-	White	256.69



## Toilets & Urinals

### Wellworth™ 2-Piece Residential Toilet

- *Exceptional Performance. Exceptional Value. Wellworth toilets have been an American benchmark for innovation and performance since 1936. With a new design in 2011, the Wellworth toilet brings an elegant flare that complements a wide range of bathroom designs.*
- *Class Five® - provides tremendous bulk waste flushing performance and best-in-class bowl cleanliness*
- *3-bolt Installation - Three pre-installed tank bolts save installation time*
- *Canister flush valve provides smooth flushing actuation with consistent water usage, flush after flush*
- *Polished chrome trip lever*
- *Less seat and supply*

THE BOLD LOOK  
 OF **KOHLER**®



#### 1.6 GPF - Elongated - 12in Rough

Part #	Mfg #	Description	Rough-In	Color	Price
940017	K-3978-0	Complete	12"	White	206.35
940003	K-4468-0	Tank	-	White	81.68
930257	K-4198-0	Bowl	12"	White	124.68

#### 1.28 GPF - Elongated - 12in Rough

Part #	Mfg #	Description	Rough-In	Color	Price
940019	K-3998-0	Complete	12"	White	206.35
940005	K-4467-0	Tank	-	White	81.68
930257	K-4198-0	Bowl	12"	White	124.68

#### 1.28 GPF - Elongated - 14in Rough

Part #	Mfg #	Description	Rough-In	Color	Price
940020	K-3848-0	Complete	14"	White	292.73
940006	K-4841-0	Tank	-	White	182.91
930257	K-4198-0	Bowl	14"	White	124.68

#### 1.6 GPF - Round - 12in Rough

Part #	Mfg #	Description	Rough-In	Color	Price
940021	K-3977-0	Complete	12"	White	171.48
940003	K-4468-0	Tank	-	White	81.68
934202	K-4197-0	Bowl	12"	White	89.80

#### 1.28 GPF - Round - 12in Rough

Part #	Mfg #	Description	Rough-In	Color	Price
940022	K-3997-0	Complete	12"	White	171.48
940005	K-4467-0	Tank	-	White	81.68
934202	K-4197-0	Bowl	12"	White	89.80

#### 1.28 GPF - Round - 14in Rough

Part #	Mfg #	Description	Rough-In	Color	Price
940023	K-3847-0	Complete	14"	White	258.08
940006	K-4841-0	Tank	-	White	182.91
934202	K-4197-0	Bowl	14"	White	89.80

Prices & specifications are subject to change.

Our office hours are 7am to 4:30pm and counter hours 6am to 4:30pm Monday through Friday.



## Toilets & Urinals

### Wellworth™ Highline™ Comfort Height™ 2-Piece Residential Toilet

- Built on the Wellworth design, the Highline series features a Comfort Height Elongated Toilet bowl - With a seat height comparable to that of a standard chair, Comfort Height toilets make sitting down and standing up easier for people of all ages

THE BOLD LOOK  
 OF **KOHLER**®

#### 1.6 GPF - Elongated - 12in Rough

Part #	Mfg #	Description	Rough-In	Color	Price
940009	K-3979-0	Complete	12"	White	236.15
940003	K-4468-0	Tank	-	White	81.68
940004	K-4199-0	Bowl	12"	White	154.47

#### 1.28 GPF - Elongated - 12in Rough

Part #	Mfg #	Description	Rough-In	Color	Price
940014	K-3999-0	Complete	12"	White	236.15
940005	K-4467-0	Tank	-	White	81.68
940004	K-4199-0	Bowl	12"	White	154.47

#### 1.28 GPF - Elongated - 14in Rough

Part #	Mfg #	Description	Rough-In	Color	Price
940015	K-3849-0	Complete	14"	White	439.55
940006	K-4841-0	Tank	-	White	182.91
940004	K-4199-0	Bowl	14"	White	154.47

#### 1.28 GPF - Elongated - 10in Rough

Part #	Mfg #	Description	Rough-In	Color	Price
940016	K-3889-0	Complete	10"	White	313.00
940005	K-4467-0	Tank	-	White	81.68
940007	K-4373-0	Bowl	10"	White	231.33

### Mansfield Alto™ Two-Piece Residential Toilet

- Traditional design
- SmartFlush gravity-fed system offers a complete flush the first time... every time
- Flapper style valve provides water conservation efficiency
- Anti-siphon ball cock affords efficient toilet tank operation at high or low water pressures
- Adjustment screw allows water level adjustment without bending the float rod
- Three-point cushioned tank-to-bowl connection assures perfect tank alignment and leak proof connections. Can't be rocked loose saves installation time
- Water usage: 1.6 gpf / 6.0 lpf
- Meets or exceeds ANSI/ASME A112.192M and A112.19.6
- Meets or exceeds Canadian Standards Association CSA B45
- Outstanding protection – China limited lifetime warranty / Tank Trim limited one year

*mansfield*



#### 10in Round

Part #	Mfg #	Description	Rough-In	Color	Price
202765	131-160	Complete	10"	White	122.04
937256	131	Bowl Only, Round	10"	White	80.74
922046	160	Tank - White	-	White	41.30





## Toilets & Urinals

### 12in Round

Part #	Mfg #	Description	Rough-In	Color	Price
163575	130-160	Complete	12"	White	78.74
922044	130	Bowl Only, Round	12"	White	37.45
922046	160	Tank - White	-	White	41.30

### 10in Elongated

Part #	Mfg #	Description	Rough-In	Color	Price
938199	138-160	Complete	10"	White	143.51
937255	138	Bowl Only, Elongated	10"	White	102.22
922046	160	Tank - White	-	White	41.30

### 12in Elongated

Part #	Mfg #	Description	Rough-In	Color	Price
163576	135-160	Complete	12"	White	96.20
936617	135	Bowl Only, Elongated	12"	White	54.90
922046	160	Tank - White	-	White	41.30

### 12in Elongated ADA

Part #	Mfg #	Description	Rough-In	Color	Price
132339	137-160	Complete ADA	12"	White	145.16
922047	137	Bowl Only, Elongated ADA	12"	White	103.86
922046	160	Tank - White	-	White	41.30

### 14in Elongated

Part #	Mfg #	Description	Rough-In	Color	Price
163576	135-160	Complete	14"	White	96.20
936617	135	Bowl Only, Elongated	14"	White	54.90
937276	125	Tank - White	-	White	88.89

### Windham™ Low Consumption 1.6 Vitreous China Toilet

- Completely code approved
- 1-Flush performance limited guarantee
- Distinctive tank styling
- (3) Bolt quick connect installation
- Seat not included
- 5-Year limited warranty



402015 - Shown with Seat

### Round - 12in Rough

Part #	Mfg #	Description	Rough-In	Color	Price
914367	402015-0	Complete	12"	White	55.20
941326	403015-0	Bowl Only, Round Front	12"	White	70.17
889174	404515-0	Tank with LH Trip, Lid & Trim	-	White	59.59

Prices & specifications are subject to change.

You can check stock availability, pricing and place orders online at [www.MetPipe.com](http://www.MetPipe.com).



## Toilets & Urinals

Plumbing

### Elongated - 10in Rough

Part #	Mfg #	Description	Rough-In	Color	Price
916794	402210-0	Complete	10"	White	Call
213219	404210-0	Bowl Only, Elongated	10"	White	154.48
889174	404515-0	Tank with LH Trip, Lid & Trim	-	White	59.59

### Elongated - 12in Rough

Part #	Mfg #	Description	Rough-In	Color	Price
236473	402215-0	Complete	12"	White	Call
927904	403215-0	Bowl Only, Elongated	12"	White	95.51
889174	404515-0	Tank with LH Trip, Lid & Trim	-	White	59.59

### Cimarron® Comfort Height® Two-Piece 1.28 GPF Toilet

- This Cimarron toilet combines versatile design with powerful flush performance. A classic two-piece style blends with traditional or contemporary decor, while an elongated bowl offers extra room for comfort. Seating is positioned at the height of a standard chair for ease of use.
- Round: 27-1/4"L x 17-5/8"W x 30-1/2"H  
 Elongated: 28-3/4"L x 17-5/8"W x 30-3/4"H
- Class Five® flushing technology provides tremendous bulk waste flushing performance and best-in-class bowl cleanliness
- Canister flush valve provides smooth flushing actuation with consistent water usage, flush after flush
- Exclusive Dry Lock™ installation system facilitates installation, and keeps floors dry
- With a seat height comparable to that of a standard chair, KOHLER Comfort Height™ toilets make sitting down and standing up easier for people of all ages
- 12"-rough-in
- Elongated bowl



THE BOLD LOOK  
 OF **KOHLER**®

### Elongated - 12in Rough

Part #	Mfg #	Description	Rough-In	Color	Price
906957	K-3589-0	Complete	12"	White	287.84
906954	K-4309-0	Elongated Bowl	12"	White	181.45
949294	K-4166-0	Tank with LH Trip, Lid & Trim	-	White	106.39

### Round - 12in Rough

Part #	Mfg #	Description	Rough-In	Color	Price
949292	K-3887-0	Complete	12"	White	250.89
949293	K-4347-0	Round Bowl	12"	White	144.50
949294	K-4166-0	Tank with LH Trip, Lid & Trim	-	White	106.39



## Toilets & Urinals

### Karsten™ Dual Force™ Low Consumption Toilet

- Dual Force™ flushing system with choice of full flush 1.6 gallons or half flush .8 gallons
- Completely code approved
- 1-Flush performance limited guarantee
- (2) Bolt installation
- Seat not included
- 5-Year limited warranty



Shown with Seat

Part #	Mfg #	Description	Height	Rough-In	Color	Price
888523	402025-0	Complete	-	-	White	209.28
890412	402021-0	Bowl Only, Round Front	15-1/8"	12"	White	140.85
891582	402023-0	Tank Only	14-1/8"	-	White	169.95

### Rockton™ Dual Force™ Low Consumption Toilet

- Dual Force™ flushing system with choice of full flush 1.6 gallons or half flush .8 gallons
- Completely code approved
- 1-Flush performance limited guarantee
- (2) Bolt installation
- Seat not included
- 5-Year limited warranty



Shown with Seat

Part #	Mfg #	Description	Height	Rough-In	Color	Price
822077	402024-0	Complete Toilet, Round Front	29-7/8"	12"	White	272.90
890412	402021-0	Bowl Only, Round Front	15-1/8"	12"	White	140.85
890413	402022-0	Tank Only	14-3/4"	-	White	143.81

## Commercial Toilets

### Highline™ Pressure Lite® 2-Piece Commercial 1.4 Toilet

- 30-1/8"L x 21-1/4"W x 31-1/4"H
- 17-1/8" High bowl is ADA compliant
- Pressure assisted flushing system
- Less seat



K-3493 Shown with Seat

Part #	Mfg #	Description	Rough-In	Color	Price
859553	K-3493-0	Complete	12"	White	352.12
859554	K-4304-0	ADA Elongated Bowl, Less Supply	12"	White	120.01
859556	K-4645-0	Tank, LH CP Trip	-	White	232.12



## Toilets & Urinals

### Mansfield QuantumOne™ High-Efficiency Commercial 2-Piece Toilet

- One gallon. One flush performance.
- Elongated front
- Rear outlet, floor-mount
- Pressure-assist, high efficiency (HET) Sloan Flushmate IV™ flushing system
- Saves up to 40% more water than conventional 1.6 gpf flushing systems
- Save more money! Qualifies for many water district rebate programs
- EPA WaterSense™ Partner - Certified to meet the WaterSense™ criteria for performance and efficiency
- Commercial rated flushing system with Map test results over 600 grams
- Water usage: 1.0 gpf / 3.8 lpf
- Meets or exceeds ANSI/ASME A112.192M and A112.19.6
- Meets or exceeds Canadian Standards Association CSA B45
- Outstanding protection – The Mansfield® ten year vessel limited warranty



#### Floor Mounted

Part #	Mfg #	Description	Rough-In	Color	Price
934603	149-153	Bowl & Tank	12"	White	352.10
937222	149	Bowl - 12in Elongated	12"	White	179.76
937224	153	Tank	-	White	172.34

#### Wall Mounted

Part #	Mfg #	Description	Rough-In	Color	Price
934604	144-153	Bowl & Tank	12"	White	418.07
936650	144	Bowl - Wall Mount	12"	White	245.73
937224	153	Tank	-	White	172.34

### Riverton™ Low Consumption 1.6 Toilet

- Completely code approved
- 1-Flush performance limited guarantee
- Modern styling
- (3) Bolt installation
- Seat not included
- 5-Year limited warranty



Shown with Seat

402502 Combination  
 404215 Elongated Bowl  
 404522 Tank

Part #	Mfg #	Description	Height	Rough-In	Color	Price
941326	403015-0	Bowl Only, Round Front	15"	12"	White	70.17
891778	404522-0	Tank Only	-	-	White	88.22



## Toilets & Urinals

THE BOLD LOOK  
OF **KOHLER**®

### Anglesey™ Commercial 1.6 Toilet - Bowl Only

- 24-1/2"L x 14-1/2"W
- 15" High bowl
- 1-1/2" Spud

THE BOLD LOOK  
OF **KOHLER**®



K-4386 Shown with Seat

Part #	Mfg #	Description	Rough-In	Color	Price
139470	K-4386-0	Elongated Bowl, Top Spud, Angle Back & Wall Outlet	4-1/2"	White	258.96

### Barrington™ Pressure Lite™ Commercial 1.6 Toilet - Bowl Only

- 15" High bowl
- Pressure Assist flushing technology
- Drains horizontally, less sleeving
- Rear-outlet

THE BOLD LOOK  
OF **KOHLER**®



Part #	Mfg #	Description	Rough-In	Color	Price
45161	K-4327-0	Elongated Bowl	4"	White	243.62

### Highcliff™ Commercial 1.6 Toilet - Bowl Only

- 24-5/8"L x 14-1/2"W
- 17-1/2" High bowl is ADA compliant
- 1-1/2" Top spud
- Less seat



THE BOLD LOOK  
OF **KOHLER**®



K-4368 Shown with Seat

K-4368-L Includes bedpan lugs

Part #	Mfg #	Description	Rough-In	Color	Price
13183	K-4368-0	ADA Elongated Bowl, 1-1/2" Top Spud	10" or 12"	White	137.11

### Highcrest™ Commercial 1.6 Toilet - Bowl Only

- 27-5/8"L x 14-1/2"W
- 16-1/2" High bowl is ADA compliant
- Siphon jet flushing technology
- 1-1/2" Top spud
- Less seat

THE BOLD LOOK  
OF **KOHLER**®



K-4302 Shown with Seat

Part #	Mfg #	Description	Rough-In	Color	Price
155891	K-4302-0	ADA Elongated Bowl, 1-1/2" Top Spud	10" or 12"	White	158.90



## Toilets & Urinals

Plumbing

### Baltic Flush Valve Commercial Toilet - Floor Mounted

- Specifically designed for commercial and industrial applications
- Elongated front
- Floor mount
- 1-1/2" top spud provided to accommodate many brands of flush valves
- Convenient maintenance — Easy to clean
- Water usage: 1.6 gpf / 6.0 lpf
- Rough-in: 10"
- Meets or exceeds ANSI/ASME A112.19.2M and A112.19.6M
- Meets or exceeds Canadian Standards Association CSA B45
- Outstanding protection – The Mansfield limited lifetime warranty
- Complies with ADA requirements for accessibility



Part #	Mfg #	Description	Rough-In	Color	Price
936625	1311	ADA Elongated Bowl, 1-1/2" Top Spud	10"	White	77.52

### Kingston™ Commercial 1.6 Toilet - Bowl Only

- 25-5/8"L x 16-3/4"W x 13-1/4"H
- 17" - 19" High installation, floor to top of seat or installed with K-4679-CA toilet seat for ADA compliance
- Less seat

THE BOLD LOOK  
 OF **KOHLER**®



K-4330 Shown with Seat

Part #	Mfg #	Description	Color	Price
13180	K-4329-0	Elongated Bowl, Wall-Mount, 1-1/2" Rear Spud	White	133.50
13181	K-4330-0	Elongated Bowl, Wall-Mount, 1-1/2" Top Spud	White	109.80
13182	K-4330-L-0	Elongated Bowl, Wall-Mount, 1-1/2" Top Spud, Bedpan Lugs	White	121.53

### Erie Flush Valve Commercial Toilet - Wall Mounted

- Specifically designed for commercial and industrial applications
- Elongated front
- Rear outlet, wall-mount
- Exceptional flushing performance siphon jet action
- Engineered to dramatically meet and exceed all ANSI weight/load bearing requirements
- Convenient maintenance — Easy to clean
- 1-1/2" top spud provided to accommodate many brands of flush valves
- Compatible with Sloan Royal 111
- Water usage: 1.6 gpf / 6.0 lpf
- Meets or exceeds ANSI/ASME A112.19.2M
- Meets or exceeds Canadian Standards Association CSA B45
- Outstanding protection – The Mansfield limited lifetime warranty
- Complies with ADA requirements for accessibility



Part #	Mfg #	Description	Color	Price
936627	1300NS	Elongated Bowl, Wall-Mount, 1-1/2" Top Spud	White	81.64



## Toilets & Urinals

THE BOLD LOOK  
OF **KOHLER**®

### Primary™ Child-Size Commercial 1.6 Toilet - Bowl Only

- 30"L x 12-7/8"W x 10-3/4"H
- 10-3/4" High bowl is ADA compliant
- Included Primary™ seat available in white, primary yellow, primary red, or primary blue

THE BOLD LOOK  
OF **KOHLER**®



Part #	Mfg #	Description	Rough-In	Color	Price
42069	K-4321-0	Elongated Bowl, 1-1/2" Top Spud	10"	White	151.34

### Sifton™ Water-Guard® Commercial Toilet - Bowl Only

- 21-1/2"L x 14"W x 15-1/4"H
- 17" - 19" High installation, floor to top of seat for ADA compliance

THE BOLD LOOK  
OF **KOHLER**®



K-4460-0 Shown with Seat

Part #	Mfg #	Description	Color	Price
13191	K-4460-C-0	Elongated Bowl, Wall-Mount, 1-1/2" Rear Spud	White	232.50

### Stratton™ Water-Guard® Commercial 3.5 Toilet - Bowl Only

- 26"L x 14"W x 11-3/4"H
- Blow-out
- 17" - 19" High installation for ADA compliance

THE BOLD LOOK  
OF **KOHLER**®



K-4450 Shown with Seat

Part #	Mfg #	Description	Color	Price
13189	K-4450-C-0	Elongated Bowl, Wall-Mount, 1-1/2" Top Spud	White	238.72

### Suffield™ Water-Guard® Commercial 3.5 Toilet - Bowl Only

- 21-1/2"L x 14"W x 11-3/4"H
- Blow-out
- Includes integral seat
- 17" - 19" High installation, floor to top of seat for ADA compliance

THE BOLD LOOK  
OF **KOHLER**®



Part #	Mfg #	Description	Color	Price
13192	K-4475-C-0	Elongated Bowl, Wall-Mount, 1-1/2" Rear Spud	White	271.90

### Wellcomme™ Commercial 1.6 Toilet - Bowl Only

- 27-5/8"L x 14-1/2" W
- 14-3/4" High bowl
- Sweat extension nipple required for 12" rough-in
- Less seat

THE BOLD LOOK  
OF **KOHLER**®



K4350 Shown With Seat

Part #	Mfg #	Description	Rough-In	Color	Price
161472	K-4349-0	Elongated Bowl, 1-1/2" Rear Spud	11"	White	225.40
13185	K-4350-0	Elongated Bowl, 1-1/2" Top Spud	10" or 12"	White	112.00

Prices & specifications are subject to change.

Metropolitan Pipe offers FREE DELIVERY in the Greater Boston area.



## Toilets & Urinals

### Wellworth™ Pressure-Lite™ Commercial 1.1 Toilet - Bowl Only

- 30-1/4"L x 21-1/4"W x 29-1/4"H
- Equipped with Sloan Flushmate™
- Includes polished chrome trip lever
- Less seat

THE BOLD LOOK  
 OF **KOHLER**®



Part #	Mfg #	Description	Rough-In	Color	Price
859557	K-4303-0	Elongated Bowl, Less Supply	12"	White	74.95

### Vitreous China Commercial Urinals

#### Bardon™ 0.5 - 1.0 Vitreous China Urinal

- Washout stall
- 14" Extended rim
- Includes removable beehive strainer, inlet & outlet spuds, hangers
- 17" High rim from finished floor for ADA compliance

THE BOLD LOOK  
 OF **KOHLER**®



Part #	Mfg #	Description	Color	Price
13221	K-4960-ET-0	Urinal, 3/4" Top Spud	White	217.16
13222	K-4960-ER-0	Urinal, 3/4" Rear Spud	White	217.16

### Mansfield Cascade Urinal 1.0GPF

- Half stall, wall-mount, wash down
- Convenient maintenance
- Easy to clean
- Integral trapway
- Concealed hanger and bolts
- Mounting bracket included
- Includes 3/4" top spud, 2" outlet spud and gaskets, two concealed hangers and bolts
- Water usage: 1.0 gpf / 3.8 lpf
- Meets or exceeds ANSI/ASME A112.19.2
- Meets or exceeds Canadian Standards Association CSA B45
- Outstanding protection
- The Mansfield limited lifetime warranty
- Complies with ADA requirements for accessibility

*mansfield*



Part #	Mfg #	Description	Color	Price
936628	410	Urinal, 3/4" Top Spud	White	163.27





## Toilets & Urinals

THE BOLD LOOK  
OF **KOHLER**®

### Dexter™ 1.0 Vitreous China Urinal

- Siphon jet
- 14-1/2" Extended rim
- Includes inlet & outlet spuds & hangers, anti-back splash wall
- 17" High mount from finished floor for ADA compliance



Part #	Mfg #	Description	Color	Price
13229	K-5016-ET-0	Elongated Urinal, 3/4" Top Spud	White	134.97

### Freshman™ 1.0 Vitreous China Urinal

- Siphon jet
- Includes inlet & outlet spuds, hanger
- 17" High mount from finished floor for ADA compliance



Part #	Mfg #	Description	Color	Price
13227	K-4989-T-0	Urinal, 3/4" Top Spud	White	242.12

### Stanwell™ 1.0 Vitreous China Urinal

- Blow-out
- Includes inlet & outlet spuds, hanger, drain plug
- 17" High mount from finished floor for ADA compliance



Part #	Mfg #	Description	Color	Price
13224	K-4972-T-0	Urinal, 1-1/4" Top Spud	White	519.81

## SLOAN

### WES Waterfree Wall-Hung Urinals

- Touch-free operation
- Uses no water; reduces water & sewer costs; water supply piping not required
- Patented, sealed locking cartridge
- Smooth, non-porous surfaces
- Odor-free & vandal resistant
- Requires minimal maintenance

**SLOAN**



Part #	Mfg #	Model	Size	Includes	Price
241717	1001000	WES-1000	19-1/4" x 14-3/8" x 26-1/4"	(2) Wall Hanger Brackets	408.21



## Toilets & Urinals

**SLOAN.**

### WES Waterfree Urinal Cartridge Kit

- Cartridge is made from recyclable ABS
- Includes:
  - 100% Biodegradable sealant liquid
  - Cartridge installation/removal tool
  - Protective glove
  - Disposal bag



WES150

Part #	Mfg #	Model	Description	Price
242438	1001500	WES-150	6,000 to 7,000 Use Urinal Cartridge Kit	44.93



### External Macerating/Grinding Bathroom Systems

- To "macerate" is to soften and break in pieces. The Saniflo macerating systems use a rotating cutting blade to liquefy human waste and toilet paper. When mixed with flushing water the waste is pumped into a sanitary sewer as a fine slurry.
- The grinder will accept accidental flushing of sanitary items such as feminine hygiene products. It grinds up waste produced in your home (i.e. toilet use, shower, washing machine, etc.) and pumps it into the public sewer system.

#### SANIBEST® Heavy-Duty External Grinding System

- SANIBEST is ideal for situations where you do not control the use; such as a guest bathroom, rental unit or office building. It is designed to handle accidental flushing of sanitary items.
- Build a complete bathroom and more; for residential and commercial applications
- Vertical pumping up to 18 ft. and 150 ft. horizontally
- Designed to work with our rear discharge toilet that only uses 1.6 gallons (6 liters) of water per flush
- Induction motor
- Power supply: 115 V - 60 Hz
- Amperage: 9.0 A
- HP: 0.8
- Discharge pipe diameter: 3/4"
- Temperature: Maximum 104.F (40.C)



Part #	Mfg #	Description	Color	Price
906788	005	Tank - Fits Sanibest & Saniplus	White	111.00
241143	003	Round Bowl - Fits Sanibest & Saniplus	White	132.00
906781	007	Elongated ADA Bowl - Fits Sanibest & Saniplus	White	166.00
906789	013	Pump for 005 tanks & 003/007 Bowls	White	999.00

Plumbing



## Macerating & Grinding Toilets



### SANIPLUS® Quiet External Macerating System

- The SANIPLUS is used to install a complete bathroom. It offers a high level of styling that makes it the ideal centerpiece for a modern bathroom.
- Build a complete bathroom for residential applications
- Vertical pumping up to 15 ft. and 150 ft. horizontally
- Designed to work with our rear discharge toilet that only uses 1.6 gallons (6 liters) of water per flush
- Induction motor
- Power supply: 115 V - 60 Hz
- Amperage: 4.5
- HP: 0.5
- Discharge: Vertically to 15 ft. (4.6m), Horizontally to 150 ft. (50m)
- Discharge pipe diameter: 3/4"
- Temperature Maximum 104.F (40.C)

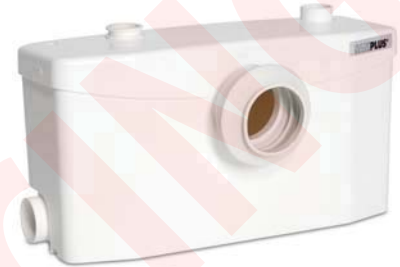

Plumbing

Part #	Mfg #	Description	Color	Price
906788	005	Tank - Fits Sanibest & Saniplus	White	111.00
896783	002	Pump for 005 tanks & 003/007 Bowls	White	790.00
241143	003	Round Bowl - Fits Sanibest & Saniplus	White	132.00
906781	007	Elongated ADA Bowl - Fits Sanibest & Saniplus	White	166.00

### Saniflo Wall Extension Pipe

- An 18" Saniflo extension pipe is available if installing the macerator unit behind a wall. When using the extension pipe, the toilet should be raised 3/8" for additional gravity flow toward the macerator.
- Length: 18"
- Diameter of pipe (smaller end): 4"
- Diameter of bell housing (Large end): 5"



Part #	Mfg #	Description	Color	Price
865671	030	Saniplus/Sanibest Extension Pipe - 18in	White	53.00

### SANISWIFT® Sink/Shower/Washing Machine/Dishwasher External Grinding System

- With unprecedented performance and features, this pump is unmatched in its class. The SANISWIFT can handle multiple fixtures to solve the most difficult installations.
- Discharges 18 gallons per minute thru 1in pipe
- Vertical pumping up to 14 ft. and 140 ft. horizontally
- Ideal for residential applications
- Powerful and economical pump with multiple inlets for various installations
- Dimensions  
83.4"H x 9"W x 101.4"D
- Induction Motor [Power supply: 115 V - 60 Hz, Amperage: 4.5 A, HP: 0.3]
- Temperature: Maximum 140°F (60°C)



Part #	Mfg #	Description	Color	Price
917866	021	Saniswift Complete Undersink Grinding System Package	White	258.00

Prices & specifications are subject to change.

Our faucet parts counter is one of the largest in the Boston area with thousands of parts in stock!



# Metropolitan Pipe & Supply

Plumbing • Heating • PVF • Industrial Supplies



## Toilets

### Qwik Jon® Sewage Removal System 102

- Designed to accommodate a toilet, lavatory and bathtub
- Perfect for basements, family rooms, warehouse, factories, room additions, etc.
- Reduces construction costs - no need to destroy concrete floors
- Toilet, fixtures and piping not included
  - Horsepower: .4, 1/2 HP, Volts: 115V, Hertz: 60 Hz
  - Thermally protected
  - Non-clogging vortex impeller
  - Cord: 10 ft UL listed, 3-wire neoprene cord and plug
- Includes:
  - Qwik Jon tank
  - Lid & gasket
  - 2" Solids-handling pump
  - Floor flange extender kit with wax rings
  - Floor flange extender kit with wax rings
  - Check valve
  - Discharge pipe to lid

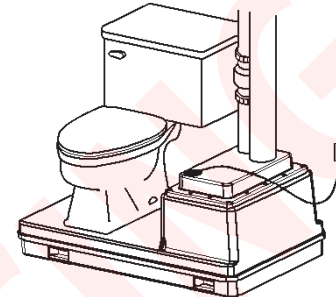

Plumbing

Part #	Mfg #	Model	Volts	Price
15806	102-0011	WM266	115V	848.71

## Minutes from Downtown Boston

Our unique location puts us close to all the action.

**303 Binney Street  
Cambridge, MA 02142**

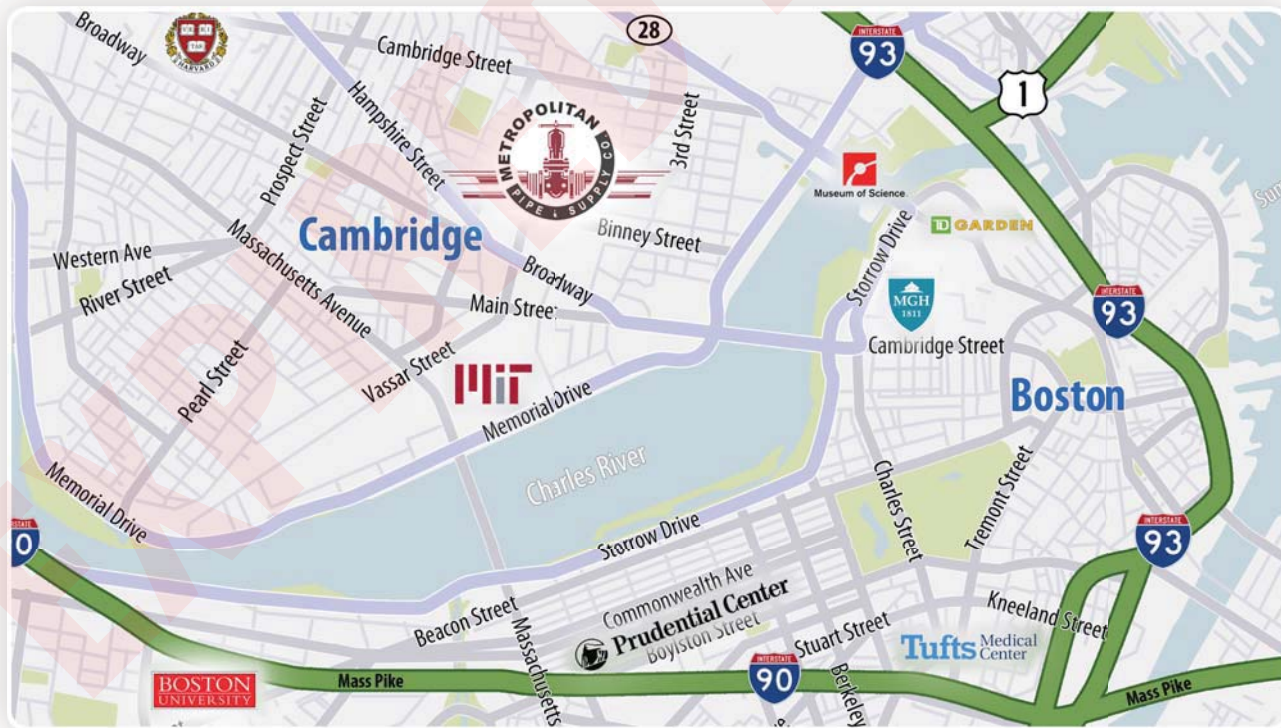



## Toilet Seats



### Premium Molded Wood Seats

#### 540/540EC Closed Front Molded Wood Seat with Cover

540 Discontinued

585TL Discontinued (Replaced by 585EC)

- Top-tightening Ultima™ hinge
- EC - Easy-Clean™ Lift-Off™, commercial

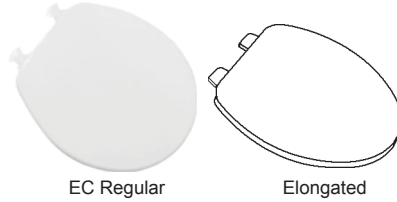

Part #	Mfg #	Style	Color	Price
12236	540-000	Regular	White	13.75
12237	585-000	Elongated	White	16.57

### Residential Plastic Seats

#### 300TC/380TC Closed Front Residential Plastic Seats with Cover

- Heavy-weight
- Top-Loc® hinge

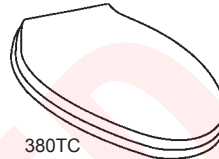

Part #	Mfg #	Style	Color	Price
12230	300TC-000	Regular	White	37.86
12262	300TC-146	Regular	Almond	41.46
12232	380TC-000	Elongated	White	48.00
12253	380TC-047	Elongated	Black	53.77
12261	380TC-146	Elongated	Almond	53.77

#### LC212 Residential Closed Front Plastic Seats with Flush-Fitting Cover

- Fits American Standard Roma, Luxor or Carlisle elongated bowls
- Color-matched plastic hinge with stainless steel posts on 10" centers

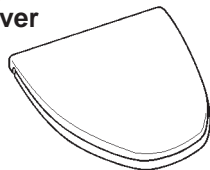

Part #	Mfg #	Style	Color	Price
12364	LC212-000	Elongated	White	182.41

#### 3TT Closed Front Residential Plastic Seats with Cover

Discontinued  
(Replaced by 3EC)

- Residential weight
- Top-Loc® hinge

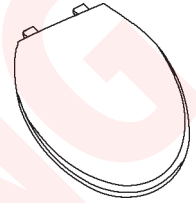

Part #	Mfg #	Style	Color	Price
12222	3TT-000	Regular	White	17.97

#### 70/170 Residential Closed Front Plastic Seat with Cover

- Standard weight
- Molded-in bumpers
- Ring thickness is 3/8"
- Color-matched Top-Tite® hinges with non-corrosive top-tightening bolts & wing nuts
- Height of seat with cover is 1-1/2"



Part #	Mfg #	Style	Color	Price
12224	70TL-000	Regular	White	13.77
12225	170-000	Elongated	White	20.68

### Commercial/Industrial Plastic Seats

#### 9400C Commercial Open Front Plastic Seats

- Posturemold® design
- Extra heavy-weight
- External check hinge with stainless steel post
- Less cover

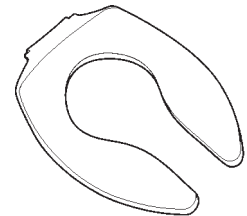

Part #	Mfg #	Style	Color	Price
143242	9400C-000	Elongated	White	34.21

#### 9500 Commercial Open Front Seat

- Extra heavy-weight
- Large molded-in bumpers
- External check hinges feature 300 Series stainless steel posts that stop seat 11° beyond vertical
- Less cover

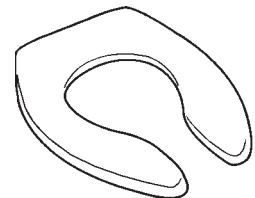

Part #	Mfg #	Style	Color	Price
12244	9500C-000	Elongated	White	41.96
12257	9500C-047	Elongated	Black	41.96
12245	9500SSC-000	Elongated	White	44.89
12258	9500SSC-047	Elongated	Black	44.89

C = Check Hinge SSC = Self-Sustaining Check Hinge



## Toilet Seats

Plumbing

### 295C/397C Open Front Commercial Seats

- Heavy-weight
- External check hinge with stainless steel post
- Less cover

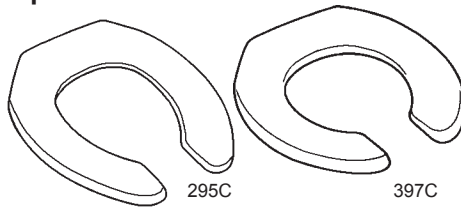

Part #	Mfg #	Style	Color	Price
12228	295C-000	Elongated	White	24.48
12250	295C-047	Elongated	Black	24.48
12234	397C-000	Regular	White	24.48
12254	397C-047	Regular	Black	24.48

SSC = Self-Sustaining and External Check Hinge

### 295SSC Open Front Commercial Seats

- With self sustaining hinges
- Less cover

Part #	Mfg #	Style	Color	Price
12229	295SSC-000	Elongated	White	27.75

SSC = Self-Sustaining and External Check Hinge

### 290TL Light Commercial Open Front Seats with Cover

- Large molded-in bumpers provide easy cleaning
- Color-matched Top-Tite® hinges contain stainless steel pintles and non-corrosive top-tightening wing nut and no-slip washer
- "Locked-in" Top-Tite® hinge design prevents wobbling
- Ring thickness is 3/4"
- Height of seat with cover is 2-1/4"



Part #	Mfg #	Style	Color	Price
12226	290TL-000	Elongated	White	49.71

### Medic-Aid® Lift Seats with Duraguard®

#### 2L2155 Open Front Lift Seats

- Allows an additional 2" of height above the rim of the bowl
- Heavy-weight
- Large molded-in bumpers
- Contains DuraGuard®, an antimicrobial agent
- External check hinge features 300 Series stainless steel posts that stop seat 11° beyond vertical
- Ring thickness is 13/16"
- Ring thickness including bumper is 2"
- Height of the seat is 3-1/4"
- Less cover



Part #	Mfg #	Style	Color	Price
56862	2L2155-000	Elongated	White	67.68

#### 4LR/4LE Lifts

- 3" Lift may be used in combination with most seats
- Allows an additional 4" of height above the rim of the bowl after seat installation
- Seat purchased separately
- Hollow core, heavy-duty plastic
- Duraguard® antimicrobial agent
- Stainless steel offset mounting bracket
- Bracket allows both lift and seat to be raised to vertical position for cleaning

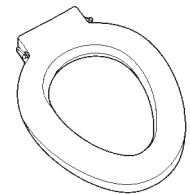

Part #	Mfg #	Style	Color	Price
54271	4LE-000	Elongated	White	142.39



**Metropolitan Pipe** is proud to be a member of the nationwide *Embassy Group*.

Our participation in this group allows us to extend better pricing and stock availability to you.

Prices & specifications are subject to change.

Metropolitan Pipe offers FREE DELIVERY in the Greater Boston area.



## Toilet Seats

### Residential Toilet Seats

#### Cachet™ Residential Seat & Cover - with Quick Release & Quiet Close

- Elongated seat design to fit elongated bowls
- Fits all one- and two-piece toilets
- Exclusive Quiet-Close technology prevents the lid from slamming and increases hygiene and safety
- Quick-Release functionality allows the seat to be removed easily from the toilet for cleaning
- Made of solid polypropylene that is resistant to staining, fading, chipping and peeling.



Part #	Mfg #	Description	Color	Price
790338	K-4636-0	Elongated Seat, Closed Front, Quick Release, Quiet Close	White	39.21
856238	K-4636-96	Elongated Seat, Closed Front, Quick Release, Quiet Close	Biscuit	51.04
242290	K-4688-0	Elongated Seat, Closed Front	White	25.08
242349	K-4688-96	Elongated Seat, Closed Front	Biscuit	28.84
857898	K-4689-0	Round Seat, Closed Front	White	22.49
890113	K-4689-96	Round Seat, Closed Front	Biscuit	25.85

#### Lustra™ Residential Seat & Cover

- Sturdy, chip-resistant polypropylene
- Finish will not stain or peel



Part #	Mfg #	Description	Color	Price
13209	K-4652-0	Elongated Seat, Closed Front	White	63.04
56018	K-4652-96	Elongated Seat, Closed Front	Biscuit	81.96
13211	K-4662-0	Round Seat, Closed Front	White	49.26
86456	K-4662-96	Round Seat, Closed Front	Biscuit	100.35

#### Brevia™ Residential Seat & Cover

- Sleek, low-profile design lines complement all KOHLER® two-piece elongated toilets
- Molded with sturdy, chip-resistant polypropylene with a finish that won't stain or peel
- Resistant to cracking
- Bumpers molded in seat will not detach
- Molded design provides less opportunity for debris to collect in seams, bumpers or hinge attachment for easy cleaning



Part #	Mfg #	Description	Color	Price
220279	K-4664-0	Elongated Seat, Closed Front	White	16.28

#### Primary™ Open Front Toilet Seat

- Solid plastic with smaller opening
- Scalloped side handles for comfort and support of young children
- Less cover
- Includes an anti-microbial agent formed into the plastic which inhibits the growth of bacteria & germs on the toilet seat



Part #	Mfg #	Description	Color	Price
131484	K-4686-A-0	Round Seat, Open Front	White	58.61



## Toilet Seats

Plumbing

### Commercial Toilet Seats

#### Lustra™ Commercial Seat

- Solid polypropylene plastic resistant to staining, fading, chipping peeling
- Open front with check hinge
- Less cover



Part #	Mfg #	Description	Color	Price
13212	K-4670-C-0	Elongated Seat, Open Front	White	22.56

### Select Kohler® Bathtubs Dynametric™ Cast Iron Recessed Bath

- Safeguard® finish
- (1) Person bathing



K-515

Part #	Mfg #	Description	Color	Price
13017	K-515-0	66" x 32" x 16-1/4", LH Drain	White	1524.63
13018	K-516-0	66" x 32" x 16-1/4", RH Drain	White	1524.63

### Mendota™ Cast Iron Recessed Bath

- Safeguard® finish
- (1) Person bathing
- ADA Compliant when installed with seat at head end



K-506

Part #	Mfg #	Description	Color	Price
13015	K-505-0	60" x 32" x 16-1/4", LH Drain	White	873.50
13016	K-506-0	60" x 32" x 16-1/4", RH Drain	White	873.50

### Seaforth™ Cast Iron Recessed Bath

- Safeguard® finish
- (1) Person bathing



K-746

Part #	Mfg #	Description	Color	Price
13023	K-745-0	54" x 30-1/4" x 14", LH Drain	White	1082.33
13024	K-746-0	54" x 30-1/4" x 14", RH Drain	White	1082.33





## Tub & Shower

### Villager™ Cast Iron Recessed Bath

- Safeguard® finish
- (1) Person bathing
- ADA Compliant when installed with seat at head end



K-715



K-716

Part #	Mfg #	Description	Color	Price
13021	K-715-0	60" x 30-1/4" x 14", LH Drain	White	404.53
13022	K-716-0	60" x 30-1/4" x 14", RH Drain	White	404.53



### Vikrell™ Showers - High Gloss Ensemble™ Series Tile Alcove Shower

- Solid Vikrell™, high-gloss finish
- Lightly pebbled, slip-resistant bottom
- Modular 4-piece design
- Tongue-and-groove "snap together" design
- 10-Year consumer, 3-year commercial limited warranty



Part #	Mfg #	Description	Size	Color	Price
892536	72101100-0	Series 7210, Base Only	36"	White	147.06
891487	72105100-0	Series 7210, Tile End Wall Set	36"-60"	White	224.24

### Ensemble™ Series Tile Alcove Shower with Shaving Ledge & Foot Rest

- Solid Vikrell™, high-gloss finish
- Lightly pebbled, slip-resistant bottom
- Shaving ledge and foot rest added for comfort
- Modular 4-piece design
- Tongue-and-groove "snap together" design
- 10-Year consumer, 3-year commercial limited warranty



Part #	Mfg #	Description	Size	Color	Price
873325	72111100-0	Series 7211, Base Only	42"	White	172.28
891490	72112100-0	Series 7211, Tile Back Wall Only	42"	White	156.21
872724	72121100-0	Series 7212, Base Only	48"	White	172.28
891484	72122100-0	Series 7212, Tile Back Wall Only	48"	White	156.21
880117	72131100-0	Series 7213, Base Only	60"	White	219.37
891576	72132100-0	Series 7213, Tile Back Wall Only	60"	White	214.55

Prices & specifications are subject to change.

We offer a variety of GREEN products such as flush valves, faucets, showerheads & more!



## Tub & Shower

Plumbing

### Ensemble™ Series Curve Alcove Shower

- Solid Vikrell™, high-gloss finish
- Lightly pebbled, slip-resistant bottom
- Shaving ledge and foot rest added for comfort
- Modular 4-piece design
- Tongue-and-groove "snap together" design
- 10-Year consumer, 3-year commercial limited warranty



Part #	Mfg #	Description	Size	Color	Price
873329	72205100-0	Series 7220, Curve End Wall Set	36" - 60"	White	217.50
892536	72101100-0	Series 7210, Base Only	36"	White	147.06
892537	72202100-0	Series 7220, Back Wall Only	36"	White	124.29
873325	72111100-0	Series 7211, Base Only	42"	White	172.28
873328	72212100-0	Series 7221, Back Wall Only	42"	White	144.55
872724	72121100-0	Series 7212, Base Only	48"	White	172.28
856143	72222100-0	Series 7222, Back Wall Only	48"	White	144.55
880117	72131100-0	Series 7213, Base Only	60"	White	219.37
891575	72232100-0	Series 7223, Back Wall Only	60"	White	179.78

### Vikrell™ Tub & Showers - High Gloss

#### Series 7109 - Acclaim™ Tub & Shower

- Made with solid Vikrell™ material
- Modular 4-piece design, durable high-gloss finish
- Tongue-and-groove interlocking joints
- 15" Bath depth
- Assembles without the need for caulk or grout for a water tight seal
- Molded-in shelving
- 10-Year consumer, 3-year commercial limited warranty

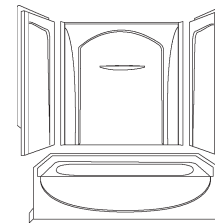

71090110

Part #	Mfg #	Description	Drain	Size	Color	Price
214587	71090110-0	Tub and Shower	Left Hand	60" x 30" x 72"	White	550.40
888630	71090120-0	Tub and Shower	Right Hand	60" x 30" x 72"	White	550.40

#### Series 7112 - Ensemble™ Tub & Shower with Tile Wall Surround

##### Tub & Wall Set Models

- Gentle sloping back, neck, and armrest in bath design
- Compression molded from Sterling's exclusive solid Vikrell™ material
- Modular 4-piece design
- Durable high gloss finish
- 18" Bath depth
- Tongue-and-groove "snap together" design allows for easy installation

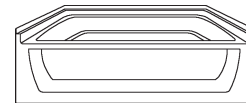

Part #	Mfg #	Description	Drain	Size	Color	Price
864349	71121110-0	Tub with Apron	Left Hand	60" x 32"	White	265.85
890415	71121120-0	Tub with Apron	Right Hand	60" x 32"	White	265.85



## Tub & Shower



### Aquatic Showers

- Aquatic products may be specified as Lasco Bathware.

#### Aquatic Remodeline 1363 Gelcoat Sectional Shower



1363-CSC

1363-2P

1363-TRIO-SC

- Smooth wall
- Molded toiletry shelf
- Requires 52" turning space
- Center drain
- Gelcoat surface
- 3-year limited warranty

Part #	Mfg #	Size	Pieces	Price
211640	1363-CSC	36 x 36	1-Piece	512.15
162754	1363-2P	36 x 36	2-Piece	641.52
905394	1363-TRIO-SC	36 x 36	3-Piece	644.04

#### Aquatic Freedomline 1363BFSC Transfer Shower

- The 1363BFSC transfer shower features innovative installation design, including an engineered leveled base and improved front threshold. A true time and money saver, our pre-leveled base lets you install directly on a level floor. And its front threshold is engineered to keep a constant level without the use of brackets during installation.

- Pre-leveled base
- Gelcoat surface
- 3/4" (20 mm) skirt
- No interior threshold
- Barrier free if properly installed
- Smooth wall
- Center drain
- 3-year limited warranty



Part #	Mfg #	Size	Drain	Price
226944	1363BFSCMA	36 x 36	Left	1473.47
226947	1363BFSCMA	36 x 36	Right	1473.47

#### Aquatic 1483CST Gelcoat Shower

- Shower stall
- Smooth wall finish
- Center drain
- Molded toiletry shelf
- Slip-resistant textured bottom



Part #	Mfg #	Size	Pieces	Price
240966	1483-CSTSC	48 x 33 1/2 x 76	1	616.72

#### Aquatic Freedomline 1603-BFSD Gelcoat Roll-in Shower

- The 1603BFSD roll-in shower features innovative installation design, including an engineered leveled base and improved front threshold. A true time and money saver, our pre-leveled base lets you install directly on a level floor. And its front threshold is engineered to keep a constant level without the use of brackets during installation.

- Pre-leveled base
- Gelcoat surface
- 3/4 (20 mm) skirt
- 1/2 (15 mm) interior threshold
- Barrier free when properly installed
- Smooth wall
- Center drain
- 3-year limited warranty



Part #	Mfg #	Size	Drain	Price
226943	1603-BFSDMA	60 x 34	Left	1546.68
226942	1603-BFSDMA	60 x 34	Right	1546.68



## Tub & Shower

Plumbing

### Aquatic Tub & Shower

- Aquatic products may be specified as Lasco Bathware.

#### Aquatic Freedomline 2603-SG Gelcoat Tub & Shower

- Tub-shower
- Left or right hand drain
- Smooth wall finish
- Ergonomic backrest
- Installed acrylic grab bar
- Molded toiletry shelves
- Slip-resistant textured bottom



Part #	Mfg #	Size	Drain	Price
211642	2603-SGLSC	60 x 32 x 72	Left	541.70
211646	2603-SGRSC	60 x 32 x 72	Right	541.70

#### Aquatic Remodeline 2603-2P 2-Piece Gelcoat Tub & Shower

- 2-piece tub-shower
- Smooth wall
- Molded toiletry shelves
- Installed acrylic grab bar
- Requires 68" turning space
- Left or right hand drain
- Gelcoat surface
- 3-year limited warranty



Part #	Mfg #	Size	Drain	Price
211649	2603-2P-LHSC	60 x 30 x 72	Left	641.16
211651	2603-2P-RHSC	60 x 30 x 72	Right	641.16

#### Aquatic Freedomline 2603-SME Gelcoat Tub & Shower

- Gelcoat surface
- 19" (480 mm) skirt
- Smooth wall
- LH or RH drain
- Partial reinforcement to accommodate standard grab bar locations. Additional reinforcement available.
- 3-year limited warranty



Part #	Mfg #	Size	Drain	Price
223471	2603-SME-L*	56 x 30 3/4 x 80	Left	1580.34
223470	2603-SME-R*	56 x 30 3/4 x 80	Right	1580.34
885245	2603-SMTHL	60 x 33 1/4 x 73 1/4	Left	Call
888716	2603-SMTH-R	60 x 33 1/4 x 73 1/4	Right	Call



**FREE Local Delivery**



## Kitchen Sinks

**ELKAY**

### Stainless Steel Kitchen Sinks

#### Lustertone® SS Self-Rimming Single Bowl Sinks

- Heavy-duty Sound Guard® undercoating
- Type 304 (18-8) nickel bearing stainless steel, 18 gauge



LR-2521 Shown with Faucet

Part #	Mfg #	Overall Size	Depth	Holes	Price
12552	LR-1517-3	15" x 17-1/2"	7-1/2"	3	429.55
12554	LR-1716-3	17" x 16"	7-1/2"	3	435.53
12555	LR-1720-3	17" x 16"	7-1/2"	3	438.19
12559	LR-1918-3	19" x 18"	7-1/2"	3	446.83
12565	LR-2219-3	22" x 19-1/2"	7-1/2"	3	485.40
12569	LR-2222-3	22" x 22"	7-1/2"	3	492.71
12579	LR-2521-3	25" x 21-1/4"	8"	3	505.35
12585	LR-2522-3	25" x 22"	8"	3	505.35
12587	LR-2522-4	25" x 22"	8"	4	505.35
115641	LRAD-1517-60-3	15" x 17-1/2"	6"	3	430.77
178652	LRAD-1720-60-3	17" x 20"	6"	3	404.29
114185	LRAD-1722-60-3	17" x 22"	6"	3	480.77
174604	LRAD-221960-3	22" x 19-1/2"	6"	3	508.67
139308	LRAD-2219-60-4	22" x 19-1/2"	6"	4	508.67
166764	LRAD-2222-60-4	22" x 22"	6"	4	621.15
51214	LRAD-2521-55-3	25" x 21"	5-1/2"	3	621.15
48396	LRAD-252260-3	25" x 22"	6"	3	531.28

#### Lustertone® SS Self-Rimming Deep Single Bowl Sinks

- Fully under coated
- 20 gauge

Type 304 Stainless Steel



DLR252210-3

Part #	Mfg #	Overall Size	Depth	Holes	Price
12561	DLR-1919-10-3	19-1/2" x 19"	10"	3	567.85
40594	DLR-2222-10-1	22" x 22"	10"	1	525.00
12572	DLR-2222-10-3	22" x 22"	10"	3	589.79
12589	DLR-2522-10-3	25" x 22"	10"	3	642.32
12590	DLR-2522-12-3	25" x 22"	12"	3	708.15

Type 316 Stainless Steel

Part #	Mfg #	Overall Size	Depth	Holes	Price
47615	MDLR-2522-10-3	25" x 22"	10"	3	951.51
12592	MDLR-2522-12-3	25" x 22"	12"	3	1049.26

Prices & specifications are subject to change.

Metropolitan Pipe offers FREE DELIVERY in the Greater Boston area.



## Kitchen Sinks

**ELKAY**

Plumbing

### Lustertone® SS Undermount Single Bowl Sinks

- Heavy-duty Sound Guard® undercoating
- Type 304 (18-8) nickel bearing stainless steel, 18 gauge



ELU-2118

Part #	Mfg #	Overall Size	Depth	Price
40433	ELU-2115	21" x 15"	7-1/2"	375.69
114699	ELU-2118	21" x 18"	7-1/2"	332.47
176762	ELU-211810	21" x 18"	10"	417.58

### Lustertone® SS Self-Rimming Double Bowl Sinks

- Fully undercoated
- Model LR has heavy duty Sound Guard® undercoating
- Type 304 (18-8) nickel bearing stainless steel, 18 gauge
- Model LRAD is ADA compliant



Part #	Mfg #	Overall Size	Depth	Holes	Price
12599	LR-3322-3	33" x 22"	8"	3	755.36

### Pacemaker® SS Self-Rimming Single Bowl Sinks

- All sinks have fully undercoated underside, PSR-2521 & PSR-2522 have Heavy duty Sound Guard® undercoating
- Type 304 (18-8) nickel bearing stainless steel, 20 gauge



Part #	Mfg #	Overall Size	Depth	Holes	Price
12560	PSR-1918-3	19" x 18"	7-1/4"	3	287.92
12567	PSR-2219-3	22" x 19-1/2"	7-1/4"	3	318.50
12593	PSR-2522-3	25" x 22"	7-1/2"	3	343.77
12594	PSR-2522-4	25" x 22"	7-1/2"	4	343.77
12601	PSR-3322-4	33" x 22"	7-1/2"	4	500.69

### Celebrity® SS Self-Rimming Single Bowl Sinks

- Fully undercoated
- Type 304 (18-8) nickel bearing stainless steel, 20 gauge

Part #	Mfg #	Overall Size	Depth	Holes	Price
12584	CR-2522-3	25" x 22"	7"	3	222.75
12586	CR-2522-4	25" x 22"	7"	4	222.75

### Celebrity® SS Self-Rimming Single Bowls

- Fully undercoated
- Type 304 (18-8) nickel bearing stainless steel, 20 gauge
- Suffix "L" (left) or "R" (right) denotes drain opening located in left or right rear corner of bowl, no suffix denotes center drain



GECCR2521-L4



GECCR2521-L3

Part #	Mfg #	Overall Size	Depth	Holes	Price
12581	GECCR-2521-L-3	25" x 21-1/4", ADA	5-3/8"	3	262.65
34002	GECCR-2521-L-4	25" x 21-1/4", ADA	5-3/8"	4	262.65
12580	GECCR-2521-R-3	25" x 21-1/4", ADA	5-3/8"	3	262.65



## Kitchen Sinks

**ELKAY**

### Stainless Steel Hospitality Sinks Celebrity® SS Self-Rimming Single Bowl Hospitality Sinks



Shown with faucet

- Fully undercoated
- Type 304 (18-8) nickel bearing stainless steel, 20 gauge

Part #	Mfg #	Overall Size	Depth	Holes	Price
12549	BCR-15-2	15" x 15" Sink Only	6"	2	169.56

### Lustertone® SS Self-Rimming Single Bowl Hospitality Sinks

- Fully undercoated underside
- Type 304 (18-8) nickel bearing stainless steel, 18 gauge
- BLR-15-C Package Includes:
  - BLR-15 Bar Sink
  - LK-2223 Deluxe 2-handle faucet with 9-7/8" high (deck to aerator) traditional swing spout
  - LK-36 Basket Strainer



BLR-15-2

Part #	Mfg #	Overall Size	Depth	Holes	Price
12550	BLR-15-2	15" x 15"	7"	2	410.26
12546	BLR-150-C	15" x 15", Faucet Package	7"	1	902.97

### Kingsford® Stainless Steel Sinks

- Good quality; seamlessly drawn of 23 gauge 300 series, nickel-bearing stainless steel
- Raised faucet deck
- All bowls finished to a buffed finish

#### Kingsford® SS Self-Rimming Single Bowl

- 4" Center set with sound deadened underside
- "J" Denotes J-channel type mounting system



K-12522-4

Part #	Mfg #	Overall Size	Depth	Holes	Pkg Qty	Price
13004	K-12522-3	25" x 22"	6-1/6"	3	1	65.75
13005	K-12522-4	25" x 22"	6-1/6"	4	1	65.75
237715	KJ5012522-3	25" x 22"	6-1/6"	3	50 (Skidded)	Call

THE BOLD LOOK  
 OF **KOHLER**

### Cast Iron Kitchen Sinks

#### Mayfield Self-Rimming Kitchen Sink w/ 4-Hold Drilling

- The compact Mayfield sink is the most popular KOHLER single-basin kitchen offering.
- Limited lifetime warranty against chipping, cracking or burning.



Part #	Mfg #	Overall Size	Depth	Holes	Pkg Qty	Price
13248	K-5964	25" x 22"	8"	4	1	203.34

Prices & specifications are subject to change.

Metropolitan Pipe offers Vendor Managed Inventory - never run out of that part again!



## Sink Accessories



Plumbing

### Badger® Garbage Disposers

- Continuous feed, PVC grind chamber
- Galvanized steel rotating shredder with (2) stainless steel, 360° slotted swivel impellers
- Permanently lubricated upper and lower bearings
- Quick-Lock™ mounting
- Overload protector manual reset
- Dishwasher drain connection
- Exclusive self-service wrenchette
- We Come To You™ service warranty



Part #	Model	HP	Warranty	Price
12990	Badger 5	1/2	2-Year	123.15
878542	Badger 5 *	1/2	2-Year	127.65

\* 3' Heavy-Duty Cord

### Evolution Series™ Residential Grade Garbage Disposers

- Dura-Drive® induction motor gives you the most horsepower of any food waste disposer
- Stainless steel grind chamber and grind component handles
- MultiGrind stages let you quickly grind food waste you wouldn't put in a standard disposer, like celery and potato peels
- 40-Ounce SS grind chamber and grind component handles more volume than standard disposers
- We Come to You™ service warranty

#### Evolution Excel™ Continuous Feed Disposers

- SoundSeal Plus™ makes the Evolution Excel™ at least 60% quieter than standard disposers
- Jam-Sensor Circuit™ automatically increases torque to break through jams



Part #	Model	HP	Grind Stages	Warranty	Price
875708	Pro-XL	1	3	7-Year	444.00

### Evolution Essential™ Continuous Feed Disposers

- SoundSeal™ makes the Evolution Essential™ at least 40% quieter than standard disposers
- 40 oz Stainless steel grind chamber and grind component handles more volume than standard disposers
- Quiet-Collar™ sink baffle ensures quiet operation



Part #	Model	HP	Grind Stages	Warranty	Price
875706	Pro-ES	3/4	2	6-Year	285.45

### Evolution Cover Control™ Batch Feed Disposers

- SoundSeal Plus™, at least 60% quieter than standard disposers
- Magnetic CoverStart™ Activation runs only when the cover is on
- Removable Sink Baffle



Part #	Model	HP	Grind Stages	Warranty	Price
875709	Pro-CC	3/4	2	7-Year	321.60

### Commercial Food Waste Disposers

#### LC-50™ Light Capacity Commercial Disposers

- Food service design with the ease and flexibility of a household unit
- Disposer mounting included, fits standard 3-1/2" - 4" sink opening
- No welding required
- Automatic reversing motor for longer life and trouble-free operation
- Standard wall switch operates the disposer
- Stainless steel grind chamber
- Cast nickel chrome cutting element
- Warranty on parts and labor



Part #	Model	HP	Grind Stages	Warranty	Price
40898	LC-50	1/2	1	1-Year	1006.00





## Sink Accessories



### SS Series Commercial Disposers

- All stainless steel and chrome plated paint-free
- Stainless steel corrosion resistant grind chamber
- 3/4" Rubber mounting above grinding chamber isolates sound & eliminates vibration
- Mounting enclosed in chrome plated covers
- Induction motor
- Stationary & rotating shredding elements made from cast nickel chrome alloy, for reverse-action grinding
- Double-tapered Timken roller bearings
- Triple lip motor seals
- Warranty from date of installation

#### Small Capacity Disposers - 1-Phase UL & CSA



Part #	Model	HP	Voltage	Warranty	Price
160738	SS-50	1/2	115/208/230	1-Year	1328.00
107734	SS-75	3/4	115/208/230	1-Year	1820.00
228425	SS-100	1	208/230/460	1-Year	1916.00

#### Medium Capacity Disposers - 3-Phase UL & CSA

Part #	Model	HP	Voltage	Warranty	Price
241585	SS125-25	1-1/4	115/208/230	1-Year	267.31
241588	SS125-26	1-1/4	208/230/460	1-Year	1919.23
228427	SS150-34	1-1/2	208/230/460	1-Year	2706.00
221695	SS200-27	2	115/208/230	1-Year	2886.00
160022	SS200-29	2	208/230-460	1-Year	2886.00

#### Large Capacity Disposers - 3-Phase UL & CSA

Part #	Model	HP	Voltage	Warranty	Price
119117	SS300-25	3	208/230/460	1-Year	3828.00
209409	SS500-28	5	208/230/460	1-Year	4807.69
187972	SS750	7-1/2	208/230/460	1-Year	9707.69
865448	SS1000	10	208/230/460	1-Year	Call

### Parts & Accessories

#### Disposer Mounting Assemblies

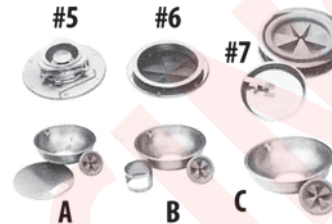

Part #	Description	Price
Call	#5 Sink flange mounting assembly for 3/4" - 4" sink opening	Call
Call	#6 Collar adapter for welding into trough, provides 6-5/8" opening, includes splash baffle	Call
Call	#7 Collar adapter for welding into sink, provides 6-5/8" opening, includes splash baffle and stopper	Call
229056	Type A Sink bowl assembly*	Call
158117	Type B Sink bowl assembly*	Call
818957	Type C Sink bowl assembly*	Call

\* Must specify either a 12", 15" or 18" bowl.

Replacing a Hobart, Waste King, Bus Boy or other similar unit?

See the next page for mounting adapters!



# Sink Accessories



Plumbing

## Adapter Chart

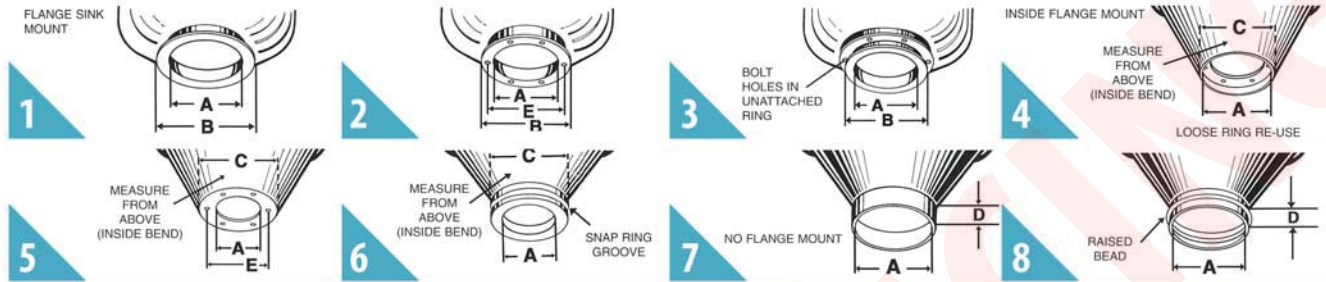

Bowl Type	Used By	"A" Diameter (Sink or bowl opening)	"B" Diameter (Outside flange)	"E" Diameter (Bolt hole circle)	No of Bolt holes (Type 2 only)	Ring Adapter #
1	Waste King, ISE, Toledo, National	4-1/2"	5-1/8"			11327A
2	Waste King, Red Goat	4-1/2"	6-1/2"	5-1/2"	6	11599
1	FMC, Avant	4-5/8"	5-1/8"			11378
1	Bus Boy	6"	6-7/8"			11327K
3	Waste King	6"	6-1/2"			11327D
1	ISE, Toledo	6"	7-3/16"			11327B
2	American Delphi, Atomic	6"	7-1/2"	6-7/8"	6	1137D
1	Standard ISE mounting	6-5/8"	7-1/8"			11599E
1	National, Hobart, Toledo	7"	7-3/8"			11327G
1	Salvajor	7"	7-3/4"			11599A
2	National, Hobart	7"	8-1/2"	8-1/16"	10	11599B
1	ISE, Toledo	8"	9-1/4"			11327
2	Hobart	9"	12-1/8"	11-1/8"	8	11327E
Bowl Type	Used By	"A" Diameter (Sink or bowl opening)	"B" Diameter (Outside flange)	"E" Diameter (Bolt hole circle)	No of Bolt holes (Type 2 only)	Ring Adapter #
5	Hobart	4-1/2"	6-7/8"	5-1/2"	6	11327H
6	Hobart	5"	5-7/8"			11327J
4	Waste King, Bus Boy	5-7/8"	6-1/2"			11327H
4	Waste King, Bus Boy	5-7/8"	6-7/8"			11327H
6	G.E.	6"	6-3/8"			11378E
Bowl Type	Used By	"A" Diameter (Sink or bowl opening)	"D" Diameter (Outside flange)			Ring Adapter #
7	Red Goat, Insinger	4-1/2"	1-1/8"			11378C
7	Waste King	6"	1-1/8"			11378A
7	Red Goat, Insinger	7"	1-1/8"			11378B
7	Master	8"	1"			11599K
8	Salvajor	4-7/16"	1"			11599N
8	Salvajor	6-5/8"	1"			11599H



# Grease Interceptors



## Interceptors

### WD Series PDI Certified Grease Interceptors

- Recess or floor mount
- Epoxy steel coated
- Gasketed solid steel cover with hex head center bolt
- Removable baffle assembly
- Deep seal trap with clean out
- No-hub connections standard
- External cast iron flow control fitting

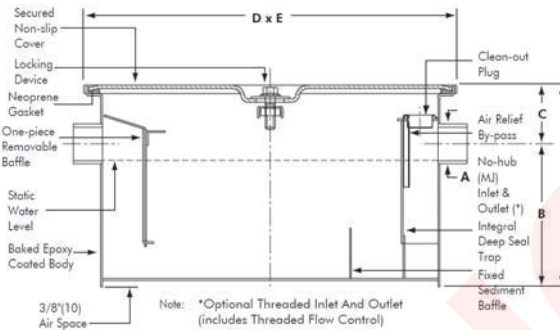

Plumbing

Part #	Mfg #	Model	Flow Rate	Grease Cap	Inlet/Outlet	"B" Base to Center	"C" Tap to Center	D Length	E Width	F Height	Price
867692	8150980	WD-4	4 gpm	7 lb	2"	7-3/4"	3-1/4"	16"	10"	11"	195.00
867691	8150981	WD-7	7 gpm	4 lb	2"	8-1/2"	3-1/2"	18"	13"	12"	198.30
204660	8150982	WD-10	10 gpm	20 lb	2"	8-1/2"	3-1/2"	21-3/4"	14"	12"	260.00
867693	8150983	WD-15	15 gpm	30 lb	2"	10-1/2"	3-1/2"	22"	15"	14"	373.33
867694	8150984	WD-20	20 gpm	40 lb	3"	11-1/2"	3-1/2"	24"	15-3/4"	15"	491.67
867695	8150985	WD-25	25 gpm	50 lb	3"	12"	4-1/2"	26"	16-1/2"	16-1/2"	656.67
867696	8150986	WD-35	35 gpm	70 lb	3"	14"	5"	30"	18"	19"	755.00
867697	8150987	WD-50	50 gpm	100 lb	4"	16"	5-1/2"	32"	22"	21-1/2"	993.33

### WD Series PDI Certified Low-Rough-In Grease Interceptors

- Recess or floor mount
- Epoxy steel coated
- Gasketed solid steel cover with hex head center bolt
- Removable baffle assembly
- Deep seal trap with clean out
- No-hub connections standard
- External cast iron flow control fitting

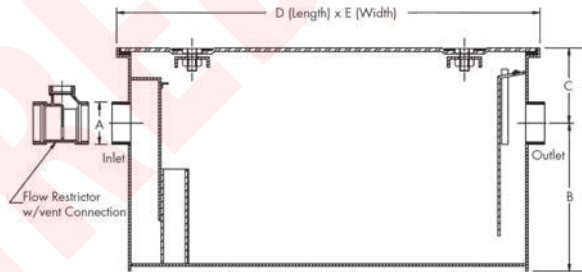

Part #	Mfg #	Model	Flow Rate	Grease Cap	Inlet/Outlet	"B" Base to Center	"C" Tap to Center	D Length	E Width	F Height	Price
867706	8185856	WD-20L	20 gpm	40 lb	3"	7-1/2"	4-1/4"	34-7/8"	22-7/8"	11-3/4"	690.00
867705	8185868	WD-35L	35 gpm	75 lb	4"	7"	4-1/2"	40-7/8"	32-7/8"	11-7/8"	7420.00
867704	8186044	WD-50L*	50 gpm	100 lb	4"	8-1/2"	5-1/2"	55"	33"	14"	2241.67

\* Not PDI Certified

## Grease Interceptor Flow Control Valves

- Tee fitting that regulates flow for grease interceptors.
- For use with: Watts WD4, WD7, WD10 and WD15



Part #	Mfg #	Size	Price
867712	8141518	2"	51.95
867713	8110666	3"	51.95
867714	8141522	4"	51.95

Prices & specifications are subject to change.

Our office hours are 7am to 4:30pm and counter hours 6am to 4:30pm Monday through Friday.



## Emergency Equipment

Plumbing

### Eye Washes

#### Deck-Mount Autoflow™

- 90° Swivel
- (2) GS-Plus spray-type spray heads with "flip top" dust cover
- Eye wash activated by swing head assembly
- 1/2" IPS



Part #	Mfg #	Description	Price
133276	G-1805	Right Hand Mounting	300.13
211144	G-1805-LH	Left Hand Mounting	300.13

#### Deck-Mount

- 90° Swivel
- (2) GS-Plus spray-type spray heads
- Eye wash activated by flag handle
- 1/2" IPS

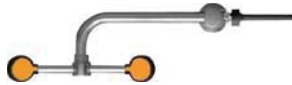

Part #	Mfg #	Description	Price
38727	G-1806	Right Hand Mounting	306.45
46396	G-1806-LH	Left Hand Mounting	306.45

#### Wall-Mount

- (2) GS-Plus spray-type spray heads
- Eye wash activated by flag handle
- 1/2" IPS inlet, 1-1/4" IPS Outlet



G-1814



G-1814-P

Part #	Mfg #	Description	Price
43344	G-1814	Stainless Steel Bowl	291.73
174356	G-1814-P	Orange ABS Plastic Bowl	225.62

### Faucet Mount

- EyeSafe™ faucet-mounted eyewashes convert any faucet into an emergency eyewash station without interfering with normal faucet operation.



G-1100

G-1101

- Forged brass diverter valve. Pull knob to activate eyewash.
- Body has 55/64"-27 female thread. Furnished with three adaptors (15/16"-27, 13/16"-27 and 3/8" IPS) for installing on most commonly used faucets.

Part #	Mfg #	Description	Price
47421	G-1100	Faucet Mount Eye Wash	83.37
145219	G-1101	Faucet Mount Eye Wash	94.77

### Drench Hose Units

#### Deck-Mount Eyewash/Drench Hose Unit

- 8' Reinforced PVC hose
- (2) GS-Plus™ spray heads with flip top dust cover
- Activated by depressing the handle



Part #	Mfg #	Description	Price
138453	G-5022	Brass Squeeze Valve	318.95

#### Speakman Deck-Mount Eyewash/Drench Hose Unit

- Twin aerated sprays
- Stay open valve
- 12' recoiling hose
- Wall mounted flange



Part #	Mfg #	Description	Price
14297	SE-921	Deck Mount Eyewash/Drench Hose Unit	231.90



## Emergency Equipment



### Speakman Eyewash/Drench Hose Wall Mount Unit

- Drench hose/eyewash
- Twin aerated sprays
- Stay open valve
- 12' recoiling hose
- Wall mounted flange.

**SPEAKMAN®**



Part #	Mfg #	Description	Price
871332	SE-925TEW	Wall Mount Eyewash/Drench Hose Unit	393.00

### Emergency Showers

#### Vertical-Mount

- Shower activated by steel pull rod with stay open ball valve
- 10" Head
- 1" Inlet



Part #	Mfg #	Description	Price
136586	G-1635	Orange ABS Plastic Showerhead	190.47

#### Horizontal-Mount

- 10" Diameter orange ABS plastic.
- 1" IPS Chrome plated brass stay-open ball valve
- Furnished with stainless steel actuating a stainless steel pull rod.
- 1" IPS Galvanized steel nipple with orange elbow.
- 1" NPT Female inlet.



Part #	Mfg #	Description	Price
38518	G-1643	Horizontally Mounted Emergency Shower	198.80

#### Recess-Mount

- Shower activated by steel pull rod with stay open ball valve
- 10" Head
- 1" Inlet



Part #	Mfg #	Description	Price
45722	G-1629	Stainless Steel Showerhead	350.21

### Safety Stations

#### Safety Shower Station with Eye Wash

- Orange ABS plastic shower head
- (2) GS-Plus™ spray heads with flip top dust cover
- Eye/face wash activated by flag handle
- Shower activated by steel pull rod
- 1-1/4" supply, 1-1/4" waste
- 10" Head



Part #	Mfg #	Description	Price
35535	G-1902	Stainless Steel Bowl	776.19
42853	G-1902-P	Orange ABS Plastic Bowl	689.37

#### Barrier-Free Safety Shower Station with WideArea™ Eye/Face Wash

- Stainless steel bowl
- (4) GS-Plus™ spray heads with flip top dust cover
- Eye/face wash activated by flag handle
- Shower activated by steel pull rod
- ADA Compliant
- 1-1/4" Supply, 1-1/4" Waste
- 10" Head



Part #	Mfg #	Description	Price
155200	GBF-1909	Plastic Showerhead	922.52

#### Recessed Swing-Down Safety Shower System with Eye/Face Wash

- (2) FS-Plus™ spray heads
- Eye wash is activated by swinging spray head assembly down from vertical to horizontal position
- 1/2" IPS Female inlet
- GBF1735 is furnished with stainless steel cabinet that is recess mounted in finished wall.



Part #	Mfg #	Description	Price
152288	GBF-1735	Wall Mount Face Wash	1203.85

Prices & specifications are subject to change.

You can check stock availability, pricing and place orders online at [www.MetPipe.com](http://www.MetPipe.com).



## Emergency Equipment

Plumbing

### Recessed Barrier-Free Safety Shower Station with Eye/Face Wash

- (2) GS-Plus™ spray heads
- Eye/face wash activated by swinging head assembly
- Shower activated by "panic bar" actuator
- 10" Head
- 1" Supply



Part #	Mfg #	Description	Price
218205	GBF-2100	Stainless Steel Showerhead	2011.56

### Recessed Barrier-Free Safety Shower Station Eye/Face Wash & Drain Pan

- (2) GS-Plus™ spray heads
- Eye/face wash and shower activated by "panic bar" actuator
- 10" Head
- 1" Supply



Part #	Mfg #	Description	Price
200551	GBF-2150	Stainless Steel Showerhead	2247.15



### Emergency Mixing Valves

- Provide tepid water for emergency showers, eye and face wash units
- DURA-trol® solid bimetal thermostatic control
- Locked temperature regulator set for 85°F
- High temperature limit stop set for 90°F
- Internal cold water bypass on failure of hot water supply

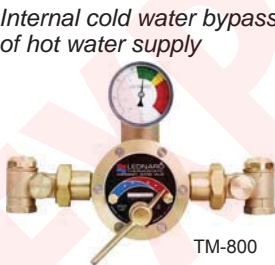

Part #	Mfg #	Description	Price
155553	TM-800-E-RF	Standard System Single or Multiple Drench or Combination Showers	1150.00
176384	TA-300	Standard System Single Eye Wash or Face Wash	648.27

### Mechanical Mixing Valves

- Integral check valves on inlets
- Compression sleeves and nuts included
- Locking dial adjustment with lever
- Brass construction, chrome-plated finish



Part #	Mfg #	Inlet	Outlet	Price
170662	20300	3/8"	3/8"	59.00

### Point-of-Use Valves

#### Model 270 Thermostatic Point-of-Use Mixing Valve (Replaces old model #220) (MIP)

- 1/2" wax type for single or multiple lavatories, sinks, or bathtubs.
- Bronze body with Stainless steel springs
- Locked temperature adjustment cap (vandal resistant)
- Copper encapsulated thermostat assembly with polymer thermoplastic shuttle
- Integral check valves on hot and cold inlets
- Maximum Hot Water temperature: 200°F- (93°C)



Part #	Mfg #	Description	Price
176878	270	1/2" Single Point Mixing Valve	119.17

### Thermostatic Mixing Valves

#### Model 210 Thermostatic Mixing Valves (Sweat)

- Line control for lavatories, showers, baths, sinks, specialized washing applications
- Thermostatic water mixing valve
- DURA-trol® solid bimetal thermostat
- Adjustable high temperature limit stop set for 110°F
- Maximum operation pressure: 125 psi
- Screwdriver-adjustable temperature dial with scale: cold-hot
- Combination straight check stops on inlets, copper tube connections
- Bronze, brass, nylon and SS construction



Part #	Mfg #	Description	Price
108013	210-F	1/2" Water Mixing with Angle Check Stops	252.64



# Mixing Valves



## Model TM Thermostatic Mixing Valves (Sweat)

- Thermostatic water mixing valves
- DURA-trol® solid bimetal thermostat
- Locked temperature adjustment setting
- Adjustable high temperature limit stop
- Union angle check stops
- Maximum operation pressure: 125 psi
- Rough bronze



Part #	Mfg #	Inlet	Outlet	Price
46835	TM-15-E-RF	1/2"	3/4"	562.47
46836	TM-20-E-RF	3/4"	3/4"	562.47
13909	TM-26-E-RF	3/4"	3/4"	619.67
13911	TM-50-E-RF	3/4"	1"	665.50
13912	TM-80-E-RF	1"	1-1/4"	772.29
13914	TM-125-E-RF	1-1/4"	1-1/4"	1004.93
13915	TM-150-E-RF	1-1/4"	1-1/2"	1060.23

## Model LV Thermostatic Mixing Valves

- Integral combination checkstops with strainers
- Models 983 & 984 have wall support
- 125 PSI (8.6 BAR) maximum operating pressure
- Copper encapsulated thermostatic assembly with Teflon coated brass shuttle
- Locking temperature regulating handle
- Top or bottom supply/outlet connections
- Internal parts of bronze, brass, and stainless steel
- Rough Bronze Finish

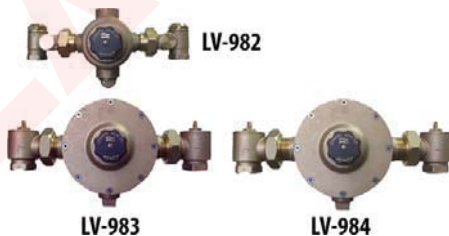

Part #	Mfg #	Inlet	Outlet	GPM	Price
943158	LV-982	1"	1-1/4"	3	786.50
943159	LV-983	1-1/4"	1-1/4"	5	977.17
943160	LV-984	1-1/4"	1-1/2"	6	1167.84

Prices & specifications are subject to change.

We offer a variety of GREEN products such as flush valves, faucets, showerheads & more!

## Leonard Valve Repair Parts

### KIT R/28 REBUILDING KIT



### REPAIR KIT 1/M20 PACKINGS & GASKETS

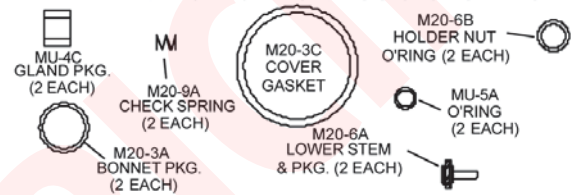

### REPAIR KIT R/M20 REBUILDING KIT

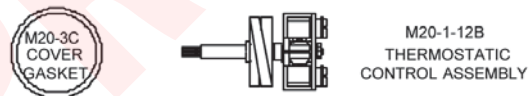

### KIT 4/M20 CHECKSTOP KIT

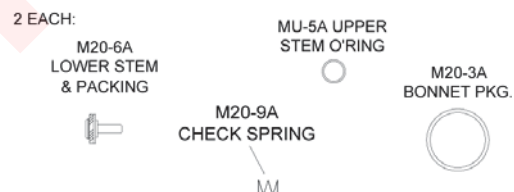

TM-15, 20, 26 Parts

Part #	Mfg #	Description	Price
24614	1/M20	Packing & Gasket Kit	51.45
24612	R/M20	Rebuild Kit	332.88
24802	R/28	Rebuild Kit	346.85
24618	4/M20	Checkstop Kit	41.20

Individual parts also available.



# Mixing Valves

Plumbing

**KIT 1/\_\_\_ PACKING & GASKET KITS**  
 KIT 1/50 FOR TM-30, TM-50, OR TM-80  
 KIT 1/125 FOR TM-125 OR TM-150  
 2 each \*\*

**KIT R/\_\_\_ REBUILDING KITS**  
 R/30 FOR TM-30  
 R/50 FOR TM-50 OR TM-80  
 R/125 FOR TM-125 OR TM-150

**KIT 2/50 CHECKSTOP KITS (ALL VALVES)**  
 2 each

**TM-50, 80, 125, 150 Parts**

Part #	Mfg #	Description	Price
24833	1/50	Packing & Gasket Kit	72.10
24858	1/125	Packing & Gasket Kit	73.60
24831	R/50	Rebuild Kit	439.20
24856	R/125	Rebuild Kit	538.40
24835	2/50	Checkstop Kit	65.20

## Dial Thermometer

- 3-1/2" Dial
- Bi-metal type



37C20A



37C30A

Part #	Mfg #	Range	Bulb	Price
13925	37C20A	20°-240°F	1.12"	71.50
13926	37C30A	0°-140°F	15/16"	71.50

# SLOAN

## Optimix® Below Deck Mixing Valves Thermostatic Tempering Valves

- For use with a multiple (up to 6) faucet installations
- Straight check stops with back checks
- Combination check stops on inlets



Part #	Mfg #	Model	Description	Price
161419	0326008	MIX-70-A	1/2" IPS Inlets & Outlets	213.25



## Water Pressure Regulators

### U5B Series Water Pressure Reducing Valves

- High performance water pressure regulators
- Provides accurate water pressure control for residential, commercial and industrial
- Bronze body construction
- Stainless steel Integral strainer
- High temperature resistant diaphragm
- Renewable stainless steel seat
- Serviceable in-line
- Temperature range: 33° to 160°F
- Maximum working pressure: 300 psi
- Adjustable reduced pressure range: 25 to 75 psi
- Standard reduced pressure setting: 50 psi
- U5B-S-Z3 - Built-in thermal expansion bypass feature
- Prefix Options:
  - LF = Lead free construction
- Suffix Options:
  - LP = Low pressure range, 10-35 psi; set @ 30 psi no-flow, 200 psi max, 180°F max
  - Z3 = Sealed spring cage, corrosion-resistant adjusting & cage screws for waterworks pit installations



### U5B (FNPT Union Inlet x FNPT Outlet)

Part #	Mfg #	Model	Size	Option	Price
16231	0052977	U5BZ3	1/2"	Std	250.72
16237	0059844	U5BLPZ3	1/2"	LP	282.65
16232	0053195	U5BZ3	3/4"	Std	293.64
16238	0059845	U5BLPZ3	3/4"	LP	331.00
16233	0049524	U5BZ3	1"	Std	446.64
16239	0057588	U5BLPZ3	1"	LP	503.30
16234	0054139	U5BZ3	1-1/4"	Std	559.43
16235	0054345	U5BZ3	1-1/2"	Std	640.78
855228	0059847	U5BLPZ3	1-1/2"	LP	626.92
16236	0054350	U5BZ3	2"	Std	1027.30

Prices & specifications are subject to change.





## Pressure Reducing Valves



### DS05 DialSet™ Pressure Regulating Valves

- For new residential and light commercial construction, drip irrigation and other applications requiring highly sensitive and accurate regulation
- Dial is calibrated in 10 psi increments to allow quick and accurate adjustment of outlet pressure
- Flow capacity and accuracy make the DS05 suitable for potable water service
- High pressure inlet rating: 400 psi
- Outlet pressure rating: 15 to 75 psi



**Honeywell**

#### Single Union Connection

Part #	Mfg #	Size		Price
876660	DS05C	1022	1/2" FNPT	61.45
876661	DS05C	1055	3/4" FNPT	65.26
876662	DS05C	1089	1" FNPT	89.87

### 25AUBZ3 Series Water Pressure Reducing Valves

- Used to reduce incoming water pressure in plumbing system components and to reduce consumption.
- Bronze body construction, union inlet connection, integral stainless steel strainer and hightemperature resistant reinforced diaphragm for hot water.
- Adjustable pressure range and is serviceable in-line.
- Maximum Working Pressure: 300psi (21 bar)
- Adjustable Reduced Pressure Range: 25 to 75psi (172 to 517 kPa)
- Standard Pressure Setting: 50psi (344kPa).



Part #	Mfg #	Model	Size		Price
880321	0068524	25AUBZ3	1/2"	Std	96.99
879313	0069717	25AUBZ3	3/4"	Std	100.87
176777	0069974	25AUBZ3	1"	Std	162.45
238715	0070311	25AUBZ3	1-1/4"	Std	303.05
161395	0070322	25AUBZ3	1-1/2"	Std	351.55
895005	0070336	25AUBZ3	2"	Std	484.87

### 223 Series Water Pressure Reducing Valves

- High capacity water pressure regulators
- Provides water pressure control for commercial, institutional and industrial
- High capacity, sealed spring cage
- Serviceable in-line
- Bronze body construction
- Temperature range: 30° to 160°F
- Maximum working pressure: 300 psi
- Adjustable reduced pressure range: 25 to 75 psi
- Standard reduced pressure setting: 50 psi



#### 223 Series (FNPT Inlet x Outlet)

Part #	Mfg #	Model	Size	Option	Price
16195	0296237	223	1/2"	-	347.20
16196	0296430	223	3/4"	-	347.20
16197	0296600	223	1"	-	537.70
16198	0296844	223	1-1/4"	-	679.47
16199	0297254	223	1-1/2"	-	778.25
16200	0297450	223	2"	-	1247.66
16201	0297460	223	2-1/2"	-	1868.60

### N223F Series Water Pressure Reducing Valves

- Super high capacity water pressure regulators
- Provides water pressure control for commercial and industrial
- Iron body, bronze & SS working parts
- Triple coated with special corrosion preventative materials
- Temperature range: 33° to 160°F
- Maximum working pressure: 175 psi
- Adjustable reduced pressure range: 25 to 75 psi
- Standard reduced pressure setting: 50 psi



#### N223F (3" Flanged)

Part #	Mfg #	Model	Size	Option	Price
206962	0306661	N223F	3"	-	1663.76

CELEBRATING  
**75** YEARS  
 1934 • 2010

Metropolitan Pipe recently celebrated 75 years of operation. Our staff, with over a century of combined experience, is always ready to tackle your next job. No one knows the industry better!

Plumbing



## Pressure Reducing Valves

Plumbing

### 26A/263A Series Water Pressure Reducing Valves

- Brass body suitable for water or No. 2 fuel oil
- For use in beverage dispensing, paint spraying equipment, drinking fountains, and more
- Temperature range: 140°F
- Maximum working pressure: 300 psi

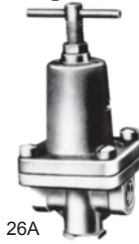

26A

#### 26A 2-Way Small Pressure Regulators (FNPT Inlet & Outlet)

Part #	Mfg #	Model	Size	PSI	Price
151821	0103185	26A "A"	1/4"	1 - 25	105.90
16315	0103187	26A "B"	1/4"	3 - 50	99.90
39930	0103193	26A "D"	1/4"	50 - 175	105.90
16317	0103197	26A "B"	3/8"	3 - 50	99.90
16318	0103200	26A "C"	3/8"	10 - 125	105.90
136813	0103500	26A "B"	1/2"	3 - 50	138.30

#### 263A 3-Way Small Pressure Regulators (FNPT Inlet & Outlet)

Part #	Mfg #	Model	Size	PSI	Price
49207	0335010	263A "B"	1/2"	3 - 50	148.95
36074	0335060	263A "P"	1/2"	20 - 175	330.70
16319	0328000	263A "B"	1/4"	3 - 50	76.65
16320	0328050	263A "B"	3/8"	3 - 50	94.15

### Steam Pressure Regulators

#### 152A Series Steam Pressure Reducing Valves

- For autoclaves, steam tables/irons, vulcanizers and single radiators, also sterilizers, process lines, testing fixtures and oil lines
- Highly sensitive to reduced pressure changes
- Sensitivity adjustment feature for critical flow

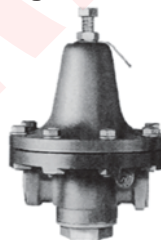

#### 152A Iron Body (FNPT Inlet and Outlet)

- Initial pressures up to 200 psi
- Stainless steel disc, seat & strainer

Part #	Mfg #	Model	Size	PSI	Price
16284	0830886	152A	1/2"	3 - 15	536.40
16285	0830910	152A	1/2"	10 - 50	536.40
16286	0830905	152A	1/2"	30 - 140	510.85
16287	0830918	152A	3/4"	3 - 15	614.90
16289	0830920	152A	3/4"	10 - 50	645.65
16290	0830928	152A	3/4"	30 - 140	645.65
16291	0830946	152A	1"	3 - 15	842.75
16292	0830945	152A	1"	10 - 30	842.75

### Steam Pressure Regulators (Continued)

#### 152A Series Steam Pressure Reducing Valves

##### 152A Iron Body (FNPT Inlet and Outlet)

Part #	Mfg #	Model	Size	PSI	Price
16293	0830950	152A	1"	30 - 140	842.75
16294	0830960	152A	1-1/4"	10 - 30	1164.25

##### Repair Kits for Series 152A

Part #	Mfg #	Model	Size	Price
16454	0875605	152ARK	3/4"	168.35
54367	0875705	152ARK	1" & 1-1/4"	210.70

# STORE HOURS

Monday - Friday  
6AM - 4:30PM

Prices & specifications are subject to change.



## Boiler Relief Valves



### ASME Hot Water Boiler Relief Valves

#### 174A Bronze Body (FNPT Inlet x Outlet - Drain)

- Bronze body construction with NPT threaded female inlet and NPT threaded female outlet (drain) connections
- Non-metallic disc-to-metal seating
- Stainless steel spring and test lever.
- Standard Pressure Setting: 30psi (206.9 kPa)
- Pressure Range: In 5psi (34.5 kPa) increments from 30 to 150psi (2 to 10 bar) with corresponding high ratings from 650,000 to 14,370,000 BTU/hr.

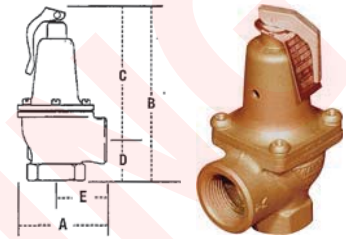

Plumbing

Part #	Mfg #	Model	Size	PSI	Dimensions (In)					Weight (Lbs)	Price
					A	B	C	D	E		
16162	0274428	174A	3/4"	30	2-1/2"	4-7/8"	3-3/4"	1-1/8"	1-5/8"	1.5	103.78
16163	0274479	174A	3/4"	40	2-1/2"	4-7/8"	3-3/4"	1-1/8"	1-5/8"	1.5	119.70
16164	0274513	174A	3/4"	50	2-1/2"	4-7/8"	3-3/4"	1-1/8"	1-5/8"	1.5	119.70
16165	0274598	174A	3/4"	75	2-1/2"	4-7/8"	3-3/4"	1-1/8"	1-5/8"	1.5	119.70
16166	0274683	174A	3/4"	100	2-1/2"	4-7/8"	3-3/4"	1-1/8"	1-5/8"	1.5	119.70
16167	0274751	174A	3/4"	125	2-1/2"	4-7/8"	3-3/4"	1-1/8"	1-5/8"	1.5	119.70
16168	0274836	174A	3/4"	150	2-1/2"	4-7/8"	3-3/4"	1-1/8"	1-5/8"	1.5	119.70
16169	0274934	174A	1"	30	3"	5-7/8"	4-3/8"	1-1/2"	1-7/8"	3.1	231.90
42503	0275022	174A	1"	40	3"	5-7/8"	4-3/8"	1-1/2"	1-7/8"	3.1	255.10
16170	0275054	174A	1"	50	3"	5-7/8"	4-3/8"	1-1/2"	1-7/8"	3.1	255.10
16171	0275174	174A	1"	75	3"	5-7/8"	4-3/8"	1-1/2"	1-7/8"	3.1	255.10
16172	0275264	174A	1"	100	3"	5-7/8"	4-3/8"	1-1/2"	1-7/8"	3.1	255.10
16173	0275404	174A	1"	125	3"	5-7/8"	4-3/8"	1-1/2"	1-7/8"	3.1	255.10
16174	0275464	174A	1"	150	3"	5-7/8"	4-3/8"	1-1/2"	1-7/8"	3.1	255.10
16175	0275600	174A	1-1/4"	30	4-3/4"	8-1/2"	6-3/8"	2-1/8"	2-3/8"	6.3	367.50
16176	0275824	174A	1-1/4"	50	4-3/4"	8-1/2"	6-3/8"	2-1/8"	2-3/8"	6.3	404.25
16177	0275825	174A	1-1/4"	75	4-3/4"	8-1/2"	6-3/8"	2-1/8"	2-3/8"	6.3	404.25
156047	0275950	174A	1-1/4"	100	4-3/4"	8-1/2"	6-3/8"	2-1/8"	2-3/8"	6.3	404.25
48311	0276050	174A	1-1/4"	125	4-3/4"	8-1/2"	6-3/8"	2-1/8"	2-3/8"	6.3	337.15
16178	0276250	174A	1-1/4"	150	4-3/4"	8-1/2"	6-3/8"	2-1/8"	2-3/8"	6.3	404.25
16179	0276500	174A	1-1/2"	30	4-7/8"	9-1/4"	6-3/4"	2-1/2"	2-5/8"	7.3	508.50
16180	0276886	174A	1-1/2"	50	4-7/8"	9-1/4"	6-3/4"	2-1/2"	2-5/8"	7.3	559.35
16181	0276770	174A	1-1/2"	75	4-7/8"	9-1/4"	6-3/4"	2-1/2"	2-5/8"	7.3	559.35
16182	0276890	174A	1-1/2"	100	4-7/8"	9-1/4"	6-3/4"	2-1/2"	2-5/8"	7.3	559.35
113242	0276980	174A	1-1/2"	125	4-7/8"	9-1/4"	6-3/4"	2-1/2"	2-5/8"	7.3	559.20
16183	0277010	174A	1-1/2"	150	4-7/8"	9-1/4"	6-3/4"	2-1/2"	2-5/8"	7.3	559.35
16184	0278030	174A	2"	30	6-1/2"	10-1/4"	7-1/4"	3"	3-3/8"	13.8	734.60
56170	0278328	174A	2"	50	6-1/2"	10-1/4"	7-1/4"	3"	3-3/8"	13.8	808.10
42010	0278330	174A	2"	75	6-1/2"	10-1/4"	7-1/4"	3"	3-3/8"	13.8	741.35
47966	0278450	174A	2"	100	6-1/2"	10-1/4"	7-1/4"	3"	3-3/8"	13.8	808.10
227971	0278480	174A	2"	125	6-1/2"	10-1/4"	7-1/4"	3"	3-3/8"	13.8	741.35
164989	0278510	174A	2"	150	6-1/2"	10-1/4"	7-1/4"	3"	3-3/8"	13.8	808.05

Prices & specifications are subject to change.

Metropolitan Pipe offers FREE DELIVERY in the Greater Boston area.



## Boiler Relief Valves

### 374A Iron Body with Bronze Inlet (FNPT Inlet x Outlet)

- Iron body construction with forged bronze inlet connections
- Non-metallic disc-to-metal seating
- Stainless steel spring and test lever
- Standard Pressure Setting: 30psi (206.9 kPa)
- Pressure range: rated up to 550,000 BTU/hr at a 30psi (2 bar) setting only.

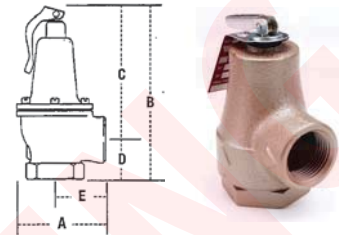

Part #	Mfg #	Model	Size	PSI	Dimensions (In)					Weight (Lbs)	Price
					A	B	C	D	E		
34041	0358553	374A	3/4"	30	2-1/2"	3-5/8"	2-3/8"	1-1/4"	1-1/2"	1.1	32.55

### 740 Series ASME Iron Body Water Pressure Safety Relief Valves

- Iron body construction with expanded outlet drain connections for hot water space heating boilers
- Non-metallic disc-to-metal seating
- Stainless steel spring and test lever.
- Pressure Range: 30 to 75psi (2 to 5 bar) with corresponding high ratings from 925,000 to 10,700,000 BTU/hr.

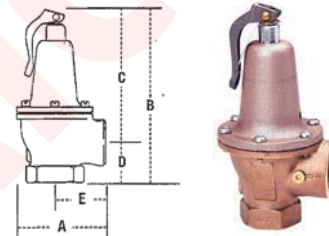

### 740 (FNPT Inlet x Outlet - Drain)

Part #	Mfg #	Model	Size	PSI	Dimensions (In)					Weight (Lbs)	Price
					A	B	C	D	E		
16185	0382008	740M1	3/4" x 1"	30	3"	5-7/8"	4-3/8"	1-1/2"	1-7/8"	1.9	112.00
16186	0382328	740M1	3/4" x 1"	50	3"	5-7/8"	4-3/8"	1-1/2"	1-7/8"	1.9	112.00
16187	0382456	740M1	3/4" x 1"	75	3"	5-7/8"	4-3/8"	1-1/2"	1-7/8"	1.9	112.00
16189	0382820	740M	1" x 1-1/4"	50	3-1/2"	7-1/4"	5-3/8"	1-7/8"	2-1/8"	3.1	195.35
16190	0382821	740M	1" x 1-1/4"	75	3-1/2"	7-1/4"	5-3/8"	1-7/8"	2-1/8"	3.1	195.35
38245	0383020	740M	1-1/4" x 1-1/2"	30	4-5/8"	8-3/4"	6-1/2"	2-1/4"	2-5/8"	6.1	281.65
38970	0383025	740M	1-1/4" x 1-1/2"	40	4-5/8"	8-3/4"	6-1/2"	2-1/4"	2-5/8"	6.1	325.35
42455	0383310	740M	1-1/4" x 1-1/2"	50	4-5/8"	8-3/4"	6-1/2"	2-1/4"	2-5/8"	6.1	295.75
42456	0383484	740M	1-1/4" x 1-1/2"	75	4-5/8"	8-3/4"	6-1/2"	2-1/4"	2-5/8"	6.1	295.75
50056	0383740	740M	1-1/2" x 2"	40	5-1/4"	9-1/4"	7"	2-1/4"	3"	7.5	455.10
42458	0383792	740M	1-1/2" x 2"	50	5-1/4"	9-1/4"	7"	2-1/4"	3"	7.5	413.70
42459	0383942	740M	1-1/2" x 2"	75	5-1/4"	9-1/4"	7"	2-1/4"	3"	7.5	394.00
39986	0384042	740M	2" x 2-1/2"	30	6-3/4"	11-5/8"	8-3/4"	2-7/8"	3-7/8"	16.5	595.35
115270	0384240	740M	2" x 2-1/2"	40	6-3/4"	11-5/8"	8-3/4"	2-7/8"	3-7/8"	16.5	654.90
42460	0384292	740M	2" x 2-1/2"	50	6-3/4"	11-5/8"	8-3/4"	2-7/8"	3-7/8"	16.5	595.35
42461	0384442	740M	2" x 2-1/2"	75	6-3/4"	11-5/8"	8-3/4"	2-7/8"	3-7/8"	16.5	567.00

See the next page for BTU/hr Steam Pressure Discharge Capacities



## Boiler Relief Valves



### BTU/hr Steam Pressure Discharge Capacities

Series 174A					
Set Pressure	3/4"	1"	1-1/4"	1-1/2"	2"
30	650,000	1,005,000	1,682,000	2,020,000	3,815,000
33	695,000	1,075,000	1,788,000	2,150,000	4,080,000
35	725,000	1,125,000	1,877,000	2,250,000	4,250,000
36	740,000	1,145,000	1,916,000	2,310,000	4,344,000
40	800,000	1,240,000	2,071,000	2,490,000	4,690,000
45	875,000	1,355,000	2,265,000	2,720,000	5,130,000
50	950,000	1,470,000	2,459,000	2,950,000	5,575,000
55	1,025,000	1,590,000	2,653,000	3,190,000	6,010,000
60	1,100,000	1,702,000	2,847,000	3,425,000	6,450,000
65	1,170,000	1,820,000	3,041,000	3,660,000	6,890,000
70	1,245,000	1,935,000	3,325,000	3,890,000	7,330,000
75	1,320,000	2,055,000	3,429,000	4,125,000	7,770,000
80	1,400,000	2,166,000	3,605,000	4,260,000	8,215,000
85	1,470,000	2,285,000	3,817,000	4,590,000	8,650,000
90	1,545,000	2,400,000	4,011,000	4,825,000	9,090,000
95	1,620,000	2,520,000	4,205,000	5,060,000	9,530,000
100	1,695,000	2,635,000	4,399,000	5,290,000	9,970,000
105	1,770,000	2,750,000	4,593,000	5,525,000	10,410,000
110	1,845,000	2,865,000	4,787,000	5,760,000	10,850,000
115	1,920,000	2,980,000	4,981,000	5,990,000	11,290,000
120	1,995,000	3,100,000	5,175,000	6,225,000	11,730,000
125	2,070,000	3,215,000	5,370,000	6,460,000	12,170,000
130	2,145,000	3,330,000	5,564,000	6,690,000	12,610,000
135	2,220,000	3,445,000	5,758,000	6,925,000	13,050,000
140	2,295,000	3,565,000	5,952,000	7,160,000	13,490,000
145	2,370,000	3,680,000	6,146,000	7,390,000	13,930,000
150	2,445,000	3,795,000	6,340,000	7,630,000	14,370,000
Series 374A					
Set Pressure	3/4"				
30	550,000				
Series 740					
Set Pressure	3/4" x 1"	1" x 1-1/4"	1-1/4" x 1-1/2"	1-1/2" x 2"	2" x 2-1/2"
30	925,000	1,300,000	2,105,000	2,900,000	5,250,000
33	989,000	1,390,000	2,250,000	3,100,000	5,613,000
35	1,032,000	1,450,000	2,345,000	3,235,000	5,855,000
36	1,053,000	1,480,000	2,395,000	3,300,000	5,975,000
40	1,139,000	1,600,000	2,590,000	3,569,000	6,461,000
45	1,245,000	1,750,000	2,830,000	3,933,000	7,067,000
50	1,352,000	1,899,000	3,075,000	4,237,000	7,672,000
55	1,459,000	2,049,000	3,315,000	4,572,000	8,277,000
60	1,566,000	2,200,000	3,560,000	4,907,000	8,883,000
65	1,672,000	2,349,000	3,800,000	5,241,000	9,488,000
70	1,779,000	2,499,000	4,045,000	5,575,000	10,093,000
75	1,886,000	2,649,000	4,285,000	5,909,000	10,700,000

Plumbing

Prices & specifications are subject to change.



# Relief Valves

Plumbing

## T&P Safety Relief Valves Self-Closing T&P Valves



- For hot water storage tanks and heaters
- Thermo-bonded (non-metallic) protective coating on thermostat
- Fully automatic, includes test levers
- Bronze body with stainless steel spring

**10L, 100XL Series ASME (MNPT Inlet x FNPT Outlet)**

- ASME Section IV

Part #	Mfg #	Model	Size	PSI	Tstat Length	Width	Height (Less Tstat)	CSA Temp Steam Rating BTU/Hr	Weight (Lbs)	Price
16220	0063072	10L2	3/4"	100	2	1-3/4"	3-1/2"	80,000	0.625	36.80
16222	0066100	100XL4	3/4"	150	4"	1-3/4"	3-1/2"	105,000	0.75	11.34
16223	0066110	100XL8	3/4"	150	8"	1-3/4"	3-1/2"	105,000	0.875	21.53

## ASME Automatic Reseating T&P Valves

- ASME Section IV for hot water supply tanks and heaters
- Fully automatic, tamper-resistant bonnet screws
- Series 40 & 140 feature unique thermostat with special thermo-bonded coating
- Bronze body construction
- Suffix Options:
  - XL = Test lever & extension thermostat
  - L = Test lever & short thermostat



340

**ASME (MNPT Inlet x FNPT Outlet)**

Part #	Mfg #	Model	Size	PSI	Tstat Length	Width	Height (Less Tstat)	ASME Pressure Steam Rating BTU/Hr @ 75 PSI	ASME Pressure Steam Rating BTU/Hr @ 150 PSI	Weight (Lbs)	Price
16224	0153614	40L3	3/4"	150	3"	2-5/8"	5-5/8"	777,600	1,437,600	1.75	164.45
16225	0156731	40XL5	3/4"	150	5"	2-5/8"	5-5/8"	777,600	1,437,600	1.75	177.65
16226	0158774	40XL8	3/4"	150	8"	2-5/8"	5-5/8"	777,600	1,437,600	1.75	169.56
16227	0163725	40XL4	1"	150	4"	2-3/4"	6-1/4"	1,555,000	2,134,000	2.25	124.68
16228	0163765	40XL7	1"	150	7"	2-3/4"	6-1/4"	1,555,000	2,134,000	2.25	278.86
16192	0318825*	N241X5	1-1/4"	150	5"	3-3/8"	6-5/8"	2,195,000	4,059,000	2.75	568.95

\* Standard - furnished with stainless steel thermostat tube

## ASME (FNPT Inlet Outlet)

- Suffix Option:
  - X = Long thermostat

Part #	Mfg #	Model	Size	PSI	Tstat Length	Width	Height (Less Tstat)	ASME Pressure Steam Rating BTU/Hr @ 75 PSI	ASME Pressure Steam Rating BTU/Hr @ 150 PSI	Weight (Lbs)	Price
16230	0259930	140X9*	1"	150	9"	3"	5-1/2"	1,670,000	3,085,000	2.25	348.60
49428	0315130	N240X6*	1"	150	6"	3-3/8"	6-5/8"	2,195,000	4,059,000	2.75	520.25
16191	0315180	N240X9*	1"	150	9"	3-3/8"	6-5/8"	2,195,000	4,059,000	2.75	585.55
16193	0344276	340-3*	1-1/2"	150	3"	4-1/2"	9-3/4"	3,450,000	6,379,000	7	998.25
16194	0348470	340X8*	1-1/2"	150	8"	4-1/2"	9-3/4"	3,450,000	6,379,000	8	1156.50

\* Standard - furnished with stainless steel thermostat tube



## Relief Valves & Backflow Preventers



### ASME Steam Boiler Safety Valves

#### ASME Steam Safety Relief Valves

- ASME Section IV
- For low pressure steam heating equipment
- Non-sticking Teflon® disc
- Seat located above drain
- Standard relief set pressure: 15 psi  
(MNPT Inlet x FNPT Outlet - Drain)



Part #	Mfg #	Model	Size	Price
179230	0342608	315-8	3/4" x 3/4"	73.30

### Conbraco 13/14 Series ASME Low Pressure Steam "Pop Safety" Boiler Valve (M x F)

- ASME Section IV LP Steam Code
- 5-15 psig Set Pressures at 250F max
- Corrosion Resistant Construction
- MADE IN THE USA



Part #	Mfg #	Size	Price
15334	13-211-B15	3/4"	55.53
15335	13-202-B15	1"	57.89
15336	13-213-B15	1-1/4"	98.11
15337	13-214-B15	1-1/2"	131.71
15338	14-205-08	2"	334.13
15339	14-206-08	2-1/2"	644.14
15340	14-207-08	3"	763.34

### Water Heater Installation Products

#### N36 Series Water Service Vacuum Relief Valves (MNPT)

- Automatically vents a closed system to atmosphere if vacuum occurs
- Allows air to enter the system and prevent vacuum conditions that could siphon water from the system
- All brass body
- Protective cap
- Suitable for low pressure steam and water service
- 15 cfm Venting capacity
- Opens at less than 1/2" vacuum
- Maximum working pressure: 200 psi
- Maximum temperature: 250°F



Part #	Mfg #	Model	Size	Price
16253	0138457	N36	1/2"	24.32

### Water Heater Installation Products (Continued)

#### N36 Series Water Service Vacuum Relief Valves (MNPT)

Part #	Mfg #	Model	Size	Price
16254	0138458	N36	3/4"	34.19

### Water Heater Pressure Relief Valves for Tankless Water Heaters

#### Poppet Type Water Heater Pressure Relief Valves

- For protection against excessive pressure and pressure emergency conditions
- Fully automatic, includes test levers
- Used in conjunction with Model 210 Gas Shut-off Valve on gas water heaters to shut off gas to heater at 210°F



Part #	Mfg #	Model	Size	PSI	Price
16256	0011917	3L	3/4"	150	21.34

#### 53L (MNPT Inlet x FNPT Outlet)

Part #	Mfg #	Model	Size	PSI	Price
16255	0190482	53L	1/2"	150	50.49
34042	0190575	53L	1/2"	175	50.49

#### 530 with Calibrated Adjustment (MNPT Inlet x FNPT Outlet)

- Ideal for bypass thermal expansion pressure relief



Part #	Mfg #	Model	Size	PSI	Price
16329	0371271	530C	1/2"	50 - 175	47.05

### Bypass Control Relief Valves

- Diaphragm type
- For pumping equipment
- Bronze body construction
- Rubber diaphragm and Teflon® disc
- Maximum temperature: 180°F



#### BP30 (MNPT Inlet x FNPT Outlet)

Part #	Mfg #	Model	Size	PSI	Price
35778	0114039	BP30A	1/2"	10 - 50	172.60

Prices & specifications are subject to change.

Our faucet parts counter is one of the largest in the Boston area with thousands of parts in stock!



# Relief Valves & Backflow Preventers



Plumbing

## Backflow Preventers

### 007 Double Check Valve Assemblies

- Protect potable water supplies in accordance with national plumbing codes
- For non-health hazard cross connections and continuous pressure applications
- Top entry
- Replaceable seats and seat discs
- Modular construction, compact design
- Max working pressure: 175 psi
- 1/2"-1" Tee handles
- Suffix Options:
  - QT = 1/4-Turn ball valves



**007 Temperature Range: 33° to 180°F**

- Cast bronze body

Part #	Mfg #	Model	Size	Option	Price
135874	0062131	007QT	1/2"	QT	154.70
16349	0062020	007M3QT	3/4"	QT	154.70
16350	0062306	007M1QT	1"	QT	186.01
16352	0062427	007M1QT	2"	QT	435.71

### Repair Kits for Series 007



Part #	Mfg #	Model	Size	Part	Price
855852	0887800	RK007UNIRT	3/4"	Univ Rubber	74.60
855853	0887801	RK007UNIRT	1"	Univ Rubber	38.10
855854	0887802	RK007UNIRT	1-1/2"	Univ Rubber	110.25
855855	0887803	RK007UNIRT	2"	Univ Rubber	81.65
144020	0887188	RK007M1RT	1-1/2"-2"	Complete Rubber	30.20

### 709 Series Double Check Backflow Preventers

- Used for non-health hazard cross connections and continuous pressure applications
- Furnished with ball type test cocks standard
- Fused epoxy coated cast iron body
- Replaceable bronze seats
- Captured spring assemblies
- Approved for vertical flow up installation
- Temperature range: 33° to 110°F
- Maximum working pressure: 175 psi
- Suffix Options:
  - OSY = UL/FM Outside stem and yoke resilient seated gate valves

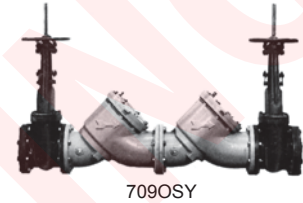

Part #	Mfg #	Model	Size	Option	Price
16355	0387023	709OSYRW	3"	OSY	2781.94
16359	0387048	709OSYRW	4"	OSY	2996.54
16361	0387054	709OSYRW	6"	OSY	4835.27

### Repair Kits for 709 Series

Part #	Mfg #	Model	Size	Part	Price
137739	0887915	RK709RT	2-1/2", 3"	Rubber Parts	129.80
50297	0887916	RK709RT	4"	Rubber Parts	173.20
47186	0887917	RK709RT	6"	Rubber Parts	197.50

### 009 Series RPZ Backflow Preventers

- Protects potable water supplies in accordance with national plumbing codes and water utility authority requirements
- Protection from high hazard cross-connections or containment at the service line entrance
- For continuous pressure use; protects against both back siphonage and back pressure backflow
- Modular construction, replaceable seats
- Captured springs
- (2) In-line independent check valves with intermediate relief valve
- Standard ball type test cocks
- Maximum working pressure: 175 psi
- Suffix Options:
  - QT = 1/4-Turn full port resilient seated bronze valve shutoffs
  - NRS = Non-rising stem resilient seated gate valves



Part #	Mfg #	Model	Size	Option	Price
16332	0062094	009QT	1/2"	QT	293.74





# Relief Valves & Backflow Preventers



## Backflow Preventers (Continued)

### 009 Series RPZ Backflow Preventers

Part #	Mfg #	Model	Size	Option	Price
16334	0063030	009M3QT	3/4"	QT	305.96
16335	0063020	009M2QT	1"	QT	330.44
16335	0063020	009M2QT	1"	QT	330.44
16336	0062920	009M2QT	1-1/4"	QT	538.50
16337	0062921	009M2QT	1-1/2"	QT	599.72
16338	0063010	009M2QT	2"	QT	673.09

### 909 Series RPZ Backflow Preventers - Bronze Sizes 3/4" - 2"

- For health hazard cross connections and continuous pressure applications
- Unique patented "air-in/water-out" design
- Provides protection in cross-connection control and containment for cold and hot water installations
- Bronze body construction
- Replaceable seats
- Ball valve test cocks
- Captured spring assemblies
- Sizes 3/4" - 1", female threaded NPT valve body connections; sizes 1-1/4" - 2", male threaded NPT valve body connections
- 3/4" & 1" Shut-offs have tee handles
- Temperature range: 33° to 110°F continuous, 140°F intermittent
- Maximum working pressure: 175 psi
- Suffix Options:
  - HW = Stainless steel check modules for hot & harsh water conditions -33-210° Range
  - QT = 1/4-Turn full port resilient seated bronze valve shutoffs

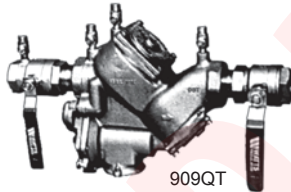

Part #	Mfg #	Model	Size	Option	Price
16374	0387121	909QT	3/4"	QT	904.71
16386	0387145	909QTHW	3/4"	QT,HW	1310.53
16375	0387129	909QT	1"	QT	1067.82
16387	0387127	909QTHW	1"	QT,HW	1551.34
16376	0385717	909M1QT	1-1/4"	QT	1675.96
16388	0385720	909M1QTHW	1-1/4"	QT,HW	2426.69
16377	0385718	909M1QT	1-1/2"	QT	1807.13
16389	0385721	909QTHW	1-1/2"	QT,HW	2633.51
16378	0385719	909M1QT	2"	QT	2081.27
16390	0385722	909M1QTHW	2"	QT,HW	3013.53

### 909 Series RPZ Backflow Preventers - Cast Iron Sizes 2-1/2" - 10"

- Unique patented "air-in/water-out" design
- Body construction of fused, epoxy-coated cast iron
- Replaceable bronze seat
- Captured spring assemblies
- Furnished with non-rising stem (NRS) resilient seated gate valve shut-offs
- Temperature range: 33° to 110°F continuous, 140°F intermittent
- Maximum working pressure: 175 psi
- Suffix Options:
  - LF = Without shutoff valves
  - NRS = Non-rising stem resilient seated gate valves
  - OSY = UL/FM Outside stem & yoke resilient seated gate valves



Shown w/Strainer

Part #	Mfg #	Model	Size	Option	Price
16379	0385811	909NRS	2-1/2"	NRS	2675.95
16391	0384880	909LF	2-1/2"	LF	1696.15
158556	0387152	909OSY	2-1/2"	OSY	6654.85
55397	0385920	909OSY	3"	OSY	3558.20
16381	0387164	909NRS	3"	NRS	3559.23
16393	0384895	909LF	3"	LF	2666.10
16395	0385801	909LF	4"	LF	2519.65
16356	0385681	909OSY	4"	OSY	3542.34
16357	0385682	909OSY	6"	OSY	5595.69

### Repair Kits for Series 909

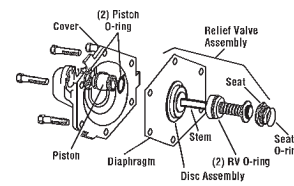

RK909VT  
3/4" to 1"

Part #	Mfg #	Model	Part	Price
34064	0887120	RK909CK1	1st Chk	111.90
56724	0887122	RK909CK1SS	1st Chk	169.85



## Relief Valves & Backflow Preventers



Plumbing

### Backflow Preventers (Continued)

#### Repair Kits for Series 909

##### 3/4" to 1"

Part #	Mfg #	Model	Part	Price
34066	0887121	RK909CK2	2nd Chk	104.80
110302	0887123	RK909CK2SS	2nd Chk	160.25
197477	0887310	RK909RC3HW	Chk Rubber	43.40
34056	0887130	RK909RT	Complete Rubber	69.25
34058	0887126	RK909VT	Total Relief	168.90

##### 1-1/4" to 2"

Part #	Mfg #	Model	Part	Price
40981	0887133	RK909M1CK1	1st Chk	204.50
34067	0887134	RK909M1CK2	2nd Chk	193.25
108057	0887136	RK909M1CK2SS	2nd Chk	276.90
38330	0887141	RK909M1RV Rubber	Relief Valve	70.35
34057	0887144	RK909RT	Complete Rubber	106.80
34059	0887138	RK909VT	Total Relief	314.60

##### 2-1/2" to 3"

Part #	Mfg #	Model	Part	Price
37210	0887210	RK909CK1	1st Chk	376.55
37212	0887211	RK909CK2	2nd Chk	361.60
37215	0887220	RK909RC1	1st Chk Rubber	67.10
34097	0887750	RK909RT	Complete Rubber	306.70
34060	0887231	RK909RV Rubber	Relief Valve	172.80
37213	0887730	RK909S	Seat Kit	143.25
55715	0887235	RK909VT	Total Relief	335.00

##### 4"

Part #	Mfg #	Model	Part	Price
44913	0887212	RK909CK1	1st Chk	609.30
34068	0887216	RK909CK2	2nd Chk	577.15
34071	0887221	RK909RC1	1st Chk Rubber	86.00
34072	0887227	RK909RC2	2nd Chk Rubber	86.00
34098	0887751	RK909RT	Complete Rubber	405.35
113850	0887731	RK909S	Seat Kit	188.75

##### 4" & 6"

Part #	Mfg #	Model	Part	Price
34061	0887232	RK909RV Rubber	Relief Valve	228.10
113851	0887236	RK909VT	Total Relief	625.50

##### 6"

Part #	Mfg #	Model	Part	Price
34099	0887752	RK909RT	Complete Rubber	425.45

### SilverEagle™ 957 Series RPZ Reduced Pressure Zone Assemblies

- Extremely compact design
- 70% Lighter than traditional designs
- 304 (Sch 40) stainless steel housing and sleeve
- Groove fittings allow integral pipeline adjustment
- Patented torsion spring checks provides lowest pressure loss
- Unmatched ease of serviceability
- Available with grooved butterfly valve shutoffs
- May be used for horizontal, vertical, N pattern or Z pattern installations
- Bottom mounted cast stainless steel relief valve
- Replaceable check disc rubber
- Temperature range: 33° to 110°F
- Maximum working pressure: 175 psi
- Suffix Options:
  - OSY = UL/FM Outside stem and yoke resilient seated gate valves



Part #	Mfg #	Model	Size	Option	Price
232908	0111585	957OSY	3"	OSY	2093.00
232736	0111586	957OSY	4"	OSY	2553.10
238673	0111587	957OSY	6"	OSY	4131.20

### Repair Kit for 957

Part #	Mfg #	Model	Size	Part	Price
232910	0899244	RK-957/ 957RPDA-RT	3"	Complete Rubber Parts	244.95
238737	0899245	RK-957/ 957RPDA-RT	2-1/2" - 4"	Complete Rubber Parts	223.75

### N9 Series Dual Check Backflow Preventers (FNPT)

- Atmospheric vent, continuous pressure applications
- Maximum pressure: 125 psi



Part #	Mfg #	Model	Size	Finish	Price
16282	0061886	N9	3/8"	Brass	90.80



## Relief Valves & Backflow Preventers



### NLF9 Series Backflow Preventers (MNPT)

- Non-continuous pressure applications
- Maximum pressure: 150 psi



Part #	Mfg #	Model	Size	Price
16281	0063052	NLF9	3/8"	69.75

### 9D Series Dual Check with Atmospheric Port Backflow Preventers (FNPT Union)

- Continuous pressure applications
- Maximum temperature: 250°F
- Maximum pressure: 175 psi, minimum 25 psi
- Suffix Options:
  - S = For 1.2" union end solder connections



Part #	Mfg #	Model	Size	Option	Price
16257	0061935	9DM3	1/2"	IPS Union	64.18
16259	0061952	9DSM3	1/2"	Solder	56.44
16258	0061888	9DM2	3/4"	IPS Union	56.46

### 9BD Series Dual Check Vending Machine / Beverage Backflow Preventers

- For vending machine water supply lines
- Complies with FDA food additive regulations
- Vented triple check protection
- Temperature range: 33° to 140°F
- Maximum working pressure: 150 psi



Part #	Mfg #	Model	Size	Price
16283	0061913	9BDNPTM	3/8" Male Flare	253.30

### 7 Series Dual Check Backflow Preventers

- For use at the drinking water supply service entrance or with individual outlets
- For non-health hazard residential water system containment and continuous pressure applications
- Brass body construction
- Uses (2) compact replaceable check modules
- Buna-N seals and stainless steel springs
- Can be installed vertically or horizontally
- Suffix Options:
  - C = Chrome nickel plate finish



Part #	Mfg #	Model	Size	Connection	Price
37199	0061856	7C	3/8"	FNPT	111.05
49254	0061783	7U22	1/2"	Union	79.36

### Backflow Preventers (Continued)

#### 7 Series Dual Check Backflow Preventers

Part #	Mfg #	Model	Size	Connection	Price
16274	0061791	7U22	3/4"	Union	85.47
16275	0061793	7U22	1"	Union	94.15

#### Model TK-9A Test Kit

- +/- 2% Accuracy full scale
- Test kit connects to any testable backflow preventer assembly
- Maximum pressure: 175 psi
- Maximum temperature: 210°F



Part #	Mfg #	Description	Price
16397	0385496	TK9A Test Kit	1894.80

#### Repair Kits for Backflow Preventers

Part #	Mfg #	Model	Price
16403	0881240	45BFPRK/900CRK	364.40
16404	0881241	46BFPRK/900CRRK	282.60
16405	0881263	47BFPRK/900FRK	669.90
16406	0881264	48BFPRK/900RUB	462.15

### Vacuum Breakers

#### 008QT Series Anti-Spill, Anti-Siphon Vacuum Breaker (FNPT)

- High hazard backflow preventer for continuous pressure applications
- Indoor point-of-use applications
- To prevent flow of contaminated water into potable water supply
- Internal polymer coating standard
- Temperature range: 33° to 180°F
- Maximum working pressure: 150 psi
- 1/4-Turn tee handles standard



Part #	Mfg #	Model	Size	Price
161042	0385423	008PCQT	1/2"	303.65

#### Repair Kits For Series 008

Part #	Mfg #	Model	Size	Part	Price
143957	0887972	RK008T	3/8" - 1/2"	Check	52.25

Prices & specifications are subject to change.

You can check stock availability, pricing and place orders online at [www.MetPipe.com](http://www.MetPipe.com).



## Relief Valves & Backflow Preventers

Plumbing

### 800M4 Series Irrigation Style Pressure Vacuum Breakers (FNPT)

- For continuous pressure applications
- Health hazard cross-connections subject to continuous pressure
- To prevent back-siphonage of contaminated water into potable water supply
- FNPT Connections
- 1/2"-1" Standard with 1/4-turn tee handle, 1-1/4"-2" standard with lever handle
- Temperature range: 33° to 140°F
- Maximum working pressure: 150 psi
- Suffix Options:
  - QT = 1/2" - 1" Tee handle 1/4-turn shut-offs



Part #	Mfg #	Model	Size	Option	Price
16371	0387096	800M4QT	1/2"	QT	150.35
16372	0388001	800M4QT	3/4"	QT	88.14
16373	0388002	800M4QT	1"	QT	99.68
37208	0387114	800M4QT	1-1/2"	QT	469.69
37211	0387122	800M4QT	2"	QT	537.33

### Universal Rubber Repair Kits

Part #	Mfg #	Model	Size	Price
855873	0887809	RK800UNIRT	1/2"	70.35
855875	0887810	RK800UNIRT	3/4"	68.30
855876	0887811	RK800UNIRT	1"	55.80
855877	0887812	RK800UNIRT	1-1/4"	89.30
855879	0887813	RK800UNIRT	1-1/2"	86.70
855880	0887814	RK800UNIRT	2"	89.30

### 288A Series Anti-Siphon Irrigation Vacuum Breakers (FNPT)

- To prevent back-siphonage of contaminated water into potable water supply
- Health hazard cross-connections not subject to continuous pressure
- Maximum temperature: 180°F
- Maximum working pressure: 125 psi



Part #	Mfg #	Model	Size	Finish	Price
112214	0339985	288AC	3/8"	Pol Chrome	86.30
16265	0336400	288A	1/2"	Plain Brass	65.20
16271	0339980	288AC	1/2"	Pol Chrome	96.05
16266	0336410	288A	3/4"	Plain Brass	77.10
16272	0339990	288AC	3/4"	Pol Chrome	112.15
16267	0336416	288A	1"	Plain Brass	120.40
16273	0340096	288AC	1"	Pol Chrome	181.25
16268	0336500	288A	1-1/4"	Plain Brass	210.90

### Repair Kits For Series 288A

Part #	Mfg #	Model	Size	Price
123532	0887170	RK188/288	1/4" - 3/8"	14.75
53463	0887171	RK288A/388T	1/2"	23.70
75298	0887172	RK188288388T	3/4" - 1"	23.70

### 8 Series Hose Connection Vacuum Breakers

- Health hazard, back siphonage protection, non-continuous supply
- Brass bodies
- For attaching to sill cocks and other hose connections
- 3/4" Hose thread female inlet x 3/4" HT male outlet connection

### 8 Removable Non-Draining Vacuum Breaker (FHT x MHT)

- Secured with Allen wrench



Part #	Mfg #	Model	Size	Finish	Price
92177	0061982	8	3/4"	RB	34.78
16262	0061985	8C	3/4"	Chrome	35.31

### 8A Non-Removable Drainable Vacuum Breaker (FHT x MHT)

- Should only be installed on approved sillcocks containing at least 4 full threads



Part #	Mfg #	Model	Size	Finish	Price
16261	0061877	8A	3/4"	RB	31.40
16263	0063055	8AC	3/4"	Chrome	37.69

### 8B Non-Removable Drainable Vacuum Breaker (FHT x MHT)

- Should only be installed on approved sillcocks containing at least 4 full threads



Part #	Mfg #	Model	Size	Finish	Price
16260	0061983	8B	3/4"	RB	12.75

### NF8 Manual Draining for Freeze Conditions Vacuum Breaker (FHT x MHT)

- Especially made for wall and yard hydrants



Part #	Mfg #	Model	Size	Finish	Price
16264	0061854	NF8	3/4"	RB	63.30

Prices & specifications are subject to change.



## Valves & Backflow Preventers



### Air Gaps

- For use with backflow preventers on horizontal installations
- Can be easily mounted to body
- Provides an unobstructed, physical separation between the discharge end of a potable water supply line and an open receiving vessel. The installation of an air gap and drain line is recommended.



Plumbing

Part #	Mfg #	Model	Series/Size	Width	Height	Weight (Lbs)	Price
16417	0881399	909AGA	1/4" - 1/2" 009, 3/4" 009M2/M3, 1/2" - 1" 995	2-3/8"	3-1/8"	.63	51.60
16418	0881376	909AGC	3/4" - 1" 009/909, 1" - 1-1/2" 009M2, 1-1/4" - 2" 995	3-1/4"	4-7/8"	1.50	63.95
16419	0881378	909AGF	1-1/4" - 3" 009/909, 1-1/4" - 2" 009M1, 2" 009M2	4-3/8"	6-3/4"	3.25	130.05
16420	0881385	909AGK	4" - 6" 909, 8" - 10" 909M1	6-3/8"	9-5/8"	6.25	263.20
858830	0111764	957AG	2-1/2" - 10" 957	7-1/2"	10-3/16"	1.5	168.35

### Bronze Test Cocks

- Facilitate backflow assembly testing or use as isolation valve for gauges or small equipment lines
- For use with backflow preventers, isolation valves for gauges, isolation valves for small equipment lines



Part #	Mfg #	Model	Size	Price
16322	0006630	TC	1/8" NPT	26.55
16323	0006635	TC	1/4" NPT	26.55
115481	0006631	EZ-TC	1/8" SAE	13.10

### Hose Assembly Kit (Sensing Line)

Part #	Mfg #	Model	Size	Price
37551	0881486	AK909	2-1/2" - 4"	147.40

### Iron Commercial Gate Valves

#### #125 CI Flanged Gate Valves - Non-Rising Stem

- Full port, low head loss
- Best suited for service in either fully open or closed position
- Use for irrigation, potable water, water distribution and feed lines, sewage disposal facilities
- Pressure rating: 200 psi CWP
- Maximum Temperature: 140°F



Part #	Mfg #	Model	Size	Price
16340	0700103	405RWNRS	2-1/2"	316.96
16341	0700104	405RWNRS	3"	393.03
16342	0700105	405RWNRS	4"	545.05
16343	0700106	405RWNRS	6"	905.34



**Pipe Fabrication Shop**  
 Cutting, threading, grooving, make-on and welding - on site!



## Strainers, Mixing Valves & Hydronic Valves

Plumbing

### Commercial Iron Gate Valves

#### 408-OS&Y-RW Series Flanged Gate Valves

- Resilient wedge
- Epoxy Coated
- UL/FM Listed
- ASTM A-126 Class B cast iron shut-off valves
- For distribution service and fire main shut-off
- Pressure rated: 175 psi CWP
- Maximum temperature: 140°F
- Outside stem and yoke (OSY)



Part #	Mfg #	Model	Size	Price
16344	0702310	408OSYRW	2-1/2"	334.98
16345	0702315	408OSYRW	3"	767.10
16346	0702320	408OSYRW	4"	456.30
16347	0702325	408OSYRW	6"	681.67

### Commercial Strainers

#### Bronze Y-Type Strainers

- For liquid or steam service
- Sizes 1/4" - 2-1/4" have 20 mesh strainer, 3" has 3/64" perforated screen

#### 777SI - Tapped Retainer Cap & Closure Plug (FNPT)

- 1/2" - 2" Rated 400 psi WOG/125 psi WSP
- 2-1/2" & 3" rated 300 psi WOG/125 psi WSP
- Closure plug included



Part #	Mfg #	Model	Size	Price
233394	0379080	777SI	3/8"	37.80
233397	0379081	777SI	1/2"	13.58
233398	0379082	777SI	3/4"	18.39
233400	0379083	777SI	1"	27.78
233401	0379084	777SI	1-1/4"	42.58
233402	0379085	777SI	1-1/2"	55.81
233403	0379086	777SI	2"	84.36
233404	0379087	777SI	2-1/2"	272.13
233405	0379088	777SI	3"	408.86

#### S777SI - Tapped Retainer Cap & Closure Plug (Sweat)

- 400 psi WOG/125 psi WSP
- Closure plug included

Part #	Mfg #	Model	Size	Price
233411	0379089	S777SI	1/2"	13.58
233412	0379090	S777SI	3/4"	18.39
233414	0379091	S777SI	1"	27.78
233415	0379092	S777SI	1-1/4"	42.58
233416	0379093	S777SI	1-1/2"	55.81

### Commercial Strainers (Continued)

#### Bronze Y-Type Strainers

#### S777SI - Tapped Retainer Cap & Closure Plug (Sweat)

Part #	Mfg #	Model	Size	Price
233417	0379094	S777SI	2"	84.36

#### Iron Body Y-Type Strainers (End Flanged)

- For liquid or steam service to protect valves, backflow preventers and similar controls from foreign matter



#### 77F-DI - ANSI 125 with Tapped Closure Plug (Flanged)

- 125 psi WSP/200 psi WOG

Part #	Mfg #	Model	Size	Price
233446	0825200	77FDI-125	2"	116.24
233447	0825201	77FDI-125	2-1/2"	116.23
233448	0825202	77FDI-125	3"	158.16
233449	0825203	77FDI-125	4"	222.76
233450	0825204	77FDI-125	5"	342.17
233451	0825205	77FDI-125	6"	461.58
233452	0825206	77FDI-125	8"	790.90
233453	0825207	77FDI-125	10"	1452.73
233454	0825208	77FDI-125	12"	2227.69

#### 77F-DI-250 - ANSI 250 with Tapped Closure Plug (Flanged)

- 250 psi WSP/500 psi WOG

Part #	Mfg #	Model	Size	Price
233456	0823041	77FDI-250	3"	474.42
233457	0823042	77FDI-250	4"	511.65

#### 77F-DI - Epoxy Coated FDA Approved - ANSI 125 with Tapped Closure Plug (Flanged)

- 200 psi WOG

Part #	Mfg #	Model	Size	Price
212688	0825210	77FDIFDA125	2-1/2"	216.20
213176	0825211	77FDIFDA125	3"	217.08
232326	0825212	77FDIFDA125	4"	310.63
215308	0825214	77FDIFDA125	6"	718.90

Prices & specifications are subject to change.



## Strainers, Mixing Valves & Hydronic Valves



### Cast Iron Y-Type Strainers

- For liquid or steam service
- Install upstream of equipment that need protection from scale, rust, dirt, etc

#### 77SI - 20 Mesh Screen, Tapped (FNPT)

- 250 psi WSP/400 psi WOG
- 2-1/2" & 3" have 3/64" perforated screen



Part #	Mfg #	Model	Size	Price
233432	0220083	77SI	3/8"	13.02
233433	0220071	77SI	1/2"	7.36
233434	0220073	77SI	3/4"	11.20
233435	0220075	77SI	1"	14.42
233436	0220077	77SI	1-1/4"	20.81
233437	0220079	77SI	1-1/2"	28.74
233438	0220081	77SI	2"	46.43
233439	0220084	77SI	2-1/2"	105.60
233442	0220085	77SI	3"	137.55

### Pipeline "Y" Strainers

#### C531 Cast Carbon Steel Y-Strainer

- Standard screens: 20 mesh of 304 SS
- Pressure drop
- NPT Tapped blow-off connection
- Working pressure non-shock: 600 psi @ 839°F Steam 1480 psi @ 100°F WOG



#### C531-S (FNPT)

Part #	Mfg #	Model	Size	Price
188299	C531S		3/4"	92.26
177524	C531S		1"	117.42
177526	C531S		2"	248.26

#### C531-SW - (Socket Weld)

Part #	Mfg #	Model	Size	Price
188300	C531SW		1/2"	78.81
188301	C531SW		3/4"	92.26
177575	C531SW		1"	117.42
177574	C531SW		1-1/2"	209.69
177571	C531SW		2"	248.26

### Tempering/Mixing Valves

#### 70A Series Hot Water Tempering Valves

- For residential installations, mixes cold and hot water to extend capacity of water heater, storage tanks and hot water boiler tankless heaters
- All brass or bronze construction, high capacity
- Adjustable knob for temperature control
- Low pressure drop



#### 70A - Temperature Range 120° to 160°F

Part #	Mfg #	Model	Size	Connection	Price
16248	0215462	70AF	1/2"	Sweat	66.77
16249	0215500	70A	3/4"	Sweat	76.31

#### Series 70A Repair Kits

Part #	Mfg #	Model	Price
16401	0869100	70ARK for 1/2" & 3/4"	30.65

### N170 Series Hot Water Tempering Valves (FNPT)

- For use in commercial and institutional applicatic
- Rough-in dimensions are identical to earlier N170 models making replacement fast and easy.
- Bronze body construction, a copper/paraffin thermostat assembly and a lockable temperature adjustment for increased safety.
- Poly sulfone internals resist excessive heat, liming and corrosion, and a single-seat design ensures tight shut-off in the event of cold water supply loss.
- Listed to ASSE 1017 and IAPMO cUPC in compliance with CSA B125.3.
- Temperature range is 90 to 180°F (32 to 82°C).
- Maximum pressure is 125 psi.



#### Temperature Range 90° to 180°F

Part #	Mfg #	Model	Size	Connection	Price
926853	0478020	N170M3	3/4"	NPT	654.30
926855	0478026	N170M3	1"	NPT	736.00
925087	0478024	N170M3	1-1/4"	NPT	1138.65
926858	0478022	N170M3	1-1/2"	NPT	1245.60
926860	0478027	N170M3	2"	NPT	1868.40

### Repair Kits for old style N170 & N170L (M1 & M2)

Part #	Mfg #	Model	Size	Price
16425	0877077	N170FRKM2	1-1/4" - 2"	197.15
39600	0877079	N170FLRKM2	1-1/4" - 2"	197.15
16424	0877075	N170CRKM2	3/4" - 1"	165.50
49722	0877076	N170LCRKM2	3/4" - 1"	180.40



# Strainers, Mixing Valves & Hydronic Valves



Plumbing

## Hydronic Valves

### Feed Water Pressure Regulators and Dual Controls for Hot Water Boilers

#### High Capacity Feed Water Regulators

- Used on boiler feed lines to provide make up water
- High capacity fast fill and purge capability
- Unitized construction
- Built-in check and strainer
- Bronze body
- Maximum pressure: 100 psi
- Maximum temperature: 212°F

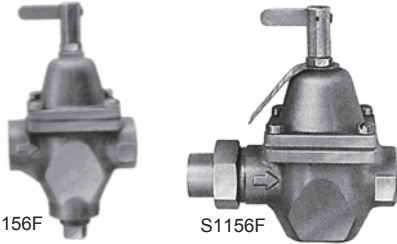

Part #	Mfg #	Model	Size	Price
216618	0386423	B1156F	1/2" FNPT	51.92
16243	0386422	SB1156F	1/2" Union Swt	51.92
16241	0322825	N256	3/4" FNPT	176.40

#### Dual Controls - Regulator and Relief Valve

- Used on boiler feed lines to provide make up water
- High capacity fast fill and purge capability
- Unitized construction
- Built-in check and strainer
- Iron and bronze construction
- Maximum pressure: 100 psi

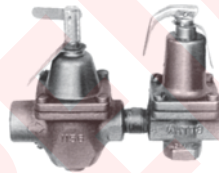

Part #	Mfg #	Model	Size	Price
16245	0388798	1450F	1/2" FNPT	148.91
16244	0388800	S1450F	1/2" Union Swt	148.93

### Combination Backflow Preventer (9D) and Fill Valve (1156F) for Hot Water Boilers - 1/2"

- Used on boiler feed lines to provide make up water to the boiler and prevent backflow when supply pressure falls below system pressure
- High capacity fast fill & purge capability
- Maximum pressure: 100 psi
- Maximum temperature: 212°F
- Suffix Options:
  - 911 = NPT x NPT Connections
  - 911S = Solder x NPT Connections
  - B Prefix indicates bronze body construction



Part #	Mfg #	Model	Description	Price
16247	0386463	B911M3	B1156F+9D Combo	115.42
16246	0386462	B911SM3	B1156F+9D Combo	115.42

## PB56 Model Purge and Balancing Valve

- For exceptionally high capacity purging
- Self-contained, tight-seating ball type
- Balancing adjustment, bronze body
- 3/4" Inlet x outlet solder with 3/4" male hose thread connection for blow-off
- Maximum temperature: 250°F
- Maximum pressure: 50 psi



Part #	Mfg #	Model	Size	Price
16280	0207500	PB56	3/4"	66.35

## P3 Series Multi-Orifice Flow Control For Tankless Heaters (Sweat)

- Designed to limit the flow of water to equipment
- Used for tankless heater installations
- Maximum temperature: 250°F
- Maximum pressure: 150 psi
- Multi-orifice cylinder
- Adjusts to 2-1/2, 3, 3-1/2 or 4 gpm



Part #	Mfg #	Model	Size	Price
16208	0008500	P3	1/2"	36.15

## TWH Series Tankless Water Heater Valves

- Series TWH tankless water heater valves are designed to simplify the installation, maintenance and operation of tankless water heaters.
- 3/4" FPT unions for connection to water heater
- 3/4" FPT/sweat unions for connection to water lines
- Full-port, quarter-turn ball valve with color-coded tee handle and union
- Quarter-turn purge and drain valve with hose connection and tethered brass cap
- Hot and cold valves certified to NSF/ANSI 61
- Staggered connection points for ease of installation and access
- Valves are suitable for most tankless installations
- No additional adapters required
- 600 WOG rated



Part #	Mfg #	Model	Size	Price
937529	0100135	TWH-UTS-HCN	1in Kit	97.56





## Strainers, Mixing Valves & Hydronic Valves



### Test Plugs

#### TP Series Test Plugs

- Temperature and pressure probe inserts into the test plug for test readings
- Economical means of balancing heating and air conditioning systems
- Pressure gauge adapter has 0.076" diameter probe of stainless steel with brass union nut



#### TP-E - Test Plug for Hot & Cold Water Service

- -40° to 275°F Temperature range

Part #	Mfg #	Model	Size	Type/Color	Price
16325	0008501	TPE	1/4"	EPDM/White	8.55
16326	0008502	TPE	1/2"	EPDM/White	8.91

#### Extensions for TP Series Test Plugs

Part #	Order #	Model	Size	Price
136760	0008504	TPX	1/4" M x F	27.10

#### Gauge Adapters - 321 SS Probe

Part #	Order #	Model	Size	Price
16328	0008514	TP-GA1	1/4"	81.30

### Water Hammers

#### 15 Series Water Hammer Arrestors (MNPT)

- Controls water pressure shock
- Commercial and industrial
- Working pressure: 150 psi
- Copper body, EPDM seals & O-rings
- NPT Solid hex brass adapter
- Factory air-charged, permanently capped and epoxy sealed
- Installs in any position



Part #	Mfg #	Model	Size	Price
16155	0750030	15	1/2"	21.38
16156	0750053	15	3/4"	21.55
16157	0750060	15	1"	56.45
16158	0750070	15	1-1/4"	118.16
16159	0750090	15	1-1/2"	175.76

### 150A Series Water Hammer Arrestors

- Controls noise from water hammering
- Maximum working pressure: 150 psi
- Maximum velocity: 10 fps
- Maximum shock pressure: 200 psi
- Pre-charged air chamber, rechargeable
- Sealed-in diaphragm



Part #	Mfg #	Model	Size	Price
16161	0269503	150A	1/2"	43.46

### Trap Primers

#### A200 Series "Flow Through" Trap Primers

- Assures delivery of water to floor drain traps to prevent evaporation of the water seal
- Complete flow cycle operates valve twice
- Built in air gap, bronze body
- Celcon® seat and disc



Part #	Mfg #	Model	Ends	Price
16321	0295121	A200T	1/2" NPT	126.49



### Flippen Float Valves & Components

#### Series ST Standard Duty Mechanical Float Valves

- Bronze body
- Cotter pin pivot arm assembly
- Replaceable seals & plungers
- Maximum pressure: 125 psi
- Maximum temperature: 180°F=

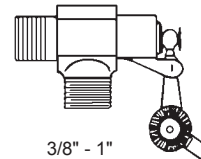

3/8" - 1"

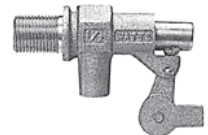

1-1/4" - 2"

Part #	Mfg #	Model	Size	Thread	Price
111035	0770180	ST500	1/2" M	1/4"-20	39.05
111036	0770181	ST750	3/4" M	1/4"-20	48.50
111040	0770182	ST1000	1" M	1/4"-20	76.95
136697	0780282	ST1250	1-1/4" F	3/8"-16	126.90
111042	0780283	ST1500	1-1/2" F	3/8"-16	149.85
111043	0780284	ST2000	2" F	3/8"-16	157.65



## Float Valves

### Stems

- Brass with threads on both ends

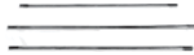

Part #	Mfg #	Model	Size	Price
136698	0780321	13	3/8" x 12"	15.70
18342	1321002	13	1/4" x 8"	2.63
18343	1321004	13	1/4" x 9"	3.16
18344	1321006	13	1/4" x 10"	2.63
18345	1321008	13	1/4" x 12"	3.16

### Copper Floats



Part #	Mfg #	Model	Size	Thread	Price
111029	0780029	C4	4"	1/4"-20	43.20
111030	0780329	C5	5"	1/4"-20	53.80
111031	0780330	C6	6"	1/4"-20	62.50
111033	0780333	C8	8"	3/8"-16	168.55
111034	0780036	C10	10"	3/8"-16	327.40



## Distribution Units

### Trap Primer Distribution Units

- For use in fresh water floor drain trap priming
- DU-U Body, Top, Two Plugs
- Patented Hyperbolic Metering Funnel assures true water distribution even when mounted off plumb.
- Each DU-U has four outlets and will be supplied with two outlet plugs, allowing the unit to evenly redistribute into a two, three or four drain application.
- Tough PVC construction compound utilized is thicker than necessary so the stress points will hold when required.
- 1/2" MNPT composite inlet
- 3/8" FPT Brass discharge fittings



Part #	Mfg #	Description	Price
235690	DU-U	Universal Unit w/(4) Discharges	31.34

## Primer Valves

### P-1 & P-2 Series Adjustable Trap Primer Valve

- The P-1 & P-2 Series of Trap Primer Valve is a precision device designed to deliver potable water to seldom used floor drains.
- Adjustable to line pressure.
- A pressure drop of 10 P.S.I.G. (70 Kpa) is required to activate the priming valve.
- The Trap Primer must be installed on cold fresh water lines of 1 1/2" diameter or less.
- The valves operating range is 20 to 80 PSIG
- 1/2" MNPT inlet, 1/2" FPT outlet



Part #	Mfg #	Description	Price
35447	P1-500	Primes 1-4 Floor Drain Traps	66.03
35448	P2-500	Primes 1-2 Floor Drain Traps	62.33

### Prime-Rite Automatic Trap Primer Valve

- This innovative trap priming system automatically primes up to two floor drain traps.
- The PRIME-RITE requires no adjustment but must be installed on a cold water line of 1 1/2" (38 mm) diameter or less.
- The priming valve is automatically activated when it senses a pressure drop of 10 PSIG
- The valve's operating range is 20 to 80 PSIG (138 to 552 kpa).
- 1/2" MNPT inlet, 1/2" FPT outlet



Part #	Mfg #	Description	Price
39724	PR-500	Primes 1-2 Floor Drain Traps	60.50

### Oregon #1 Diaphragm Automatic Trap Primer Valve

- The OREGON #1 Trap Primer Valve is a diaphragm operated primer which delivers a fresh water prime to seldom used floor drains.
- This primer requires no adjustment but must be installed on a cold fresh water line of 1 1/2" diameter or less.
- The primer valve is automatically activated when it senses a pressure drop of 10 PSIG.
- The valve's operating range is 20 to 80 PSIG.
- Automatically maintains a constant water seal in floor drain traps.
- Best for use with low flow fixtures, when potential pressure drop is reduced.
- Automatically adjusts to line pressure with proper delivery amount.



Part #	Mfg #	Description	Price
35449	PO-500	Primes 1-2 Floor Drain Traps	58.09



# Plumbing Valves, Supplies & Connectors



## Multi-Turn Stop Valves

### Straight Stops (Comp x Comp)

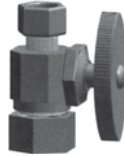

Part #	Mfg #	Nom x OD	Finish	Price
11922	OCR14 C	1/2" x 3/8"	CP	13.94
11923	OCR14 R	1/2" x 3/8"	RB	13.11

### Straight Stops (FIP x Comp)



Part #	Mfg #	FIP x OD	Finish	Price
11915	OR10 C	3/8" x 3/8"	CP	12.73
11926	OR12 C	1/2" x 3/8"	CP	12.73
11916	OR10 R	3/8" x 3/8"	RB	11.97
11927	OR12 R	1/2" x 3/8"	RB	11.97

### Straight Stops (Sweat x Comp)

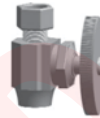

Part #	Mfg #	Nom x OD	Finish	Price
11918	R14 C	1/2" x 3/8"	CP	13.18
11920	R34 C	1/2" x 1/2"	CP	18.09
11917	R04 R	1/2" x 1/4"	RB	16.96
11919	R14 R	1/2" x 3/8"	RB	9.68
11921	R34 R	1/2" x 1/2"	RB	14.58

### Straight Stops (5" Sweat Extension x Comp)

- With bell escutcheon



Part #	Mfg #	Nom x OD	Finish	Price
11949	CS47 C	1/2" x 1/2"	CP	45.36
11945	CS41B C	1/2" Comp w/Ext x 3/8"	CP	26.75

### Angle Stops (Comp x Comp)

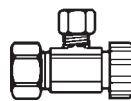

Part #	Mfg #	Nom x OD	Finish	Price
11935	OCR19 C	1/2" x 3/8"	CP	13.18
11936	OCR19 R	1/2" x 3/8"	RB	12.48

### Angle Stops (FIP x Comp)



Part #	Mfg #	FIP x OD	Finish	Price
11928	OR15 C	3/8" x 3/8"	CP	12.11
11930	OR17 C	1/2" x 3/8"	CP	12.11
11929	OR15 R	3/8" x 3/8"	RB	11.31
11931	OR17 R	1/2" x 3/8"	RB	11.31

### Angle Stops (Sweat x Comp)



Part #	Mfg #	Nom x OD	Finish	Price
11934	R19 C	1/2" x 3/8"	CP	12.18
11933	R19 R	1/2" x 3/8"	RB	8.97

### Angle Stops (5" Sweat Extension x Comp)

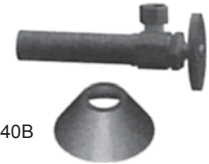

Part #	Mfg #	Nom x OD	Finish	Price
11943	CS40B C*	1/2" x 3/8"	CP	24.17
11947	CS46 C	1/2" x 1/2"	CP	36.99

\* Includes Bell Escutcheon

### Angle Stops (FIP x FIP)

Part #	Mfg #	FIP x FIP	Finish	Price
11942	OR95 C	3/8" x 3/8"	CP	18.60

## Water Ball Stops - 1/4-Turn On-Off

- PTFE Seats provide corrosion resistance and watertight seal
- Blow-out proof stem
- Plated stem
- 100% Leak tested



### Straight Stops (Comp x Comp)

Part #	Mfg #	Nom x OD	Finish	Price
235378	KTCR11 C	1/4" x 3/8"	CP	24.11
235379	KTCR11F-C1	3/8" x 3/8"	CP	20.24

### Angle Stops (FIP x Comp)

Part #	Mfg #	Nom x OD	Finish	Price
200970	KTR15C	3/8" x 3/8"	CP	12.20

Prices & specifications are subject to change.

Metropolitan Pipe offers Vendor Managed Inventory - never run out of that part again!



**Plumbing Valves, Supplies & Connectors**



**Straight Stops  
(Sweat x Comp)**



Part #	Mfg #	Nom x OD	Finish	Price
200966	KTR14 C	1/2" x 3/8"	CP	12.20

**Angle Stops (Sweat x Comp)**

Part #	Mfg #	Nom x OD	Finish	Price
200969	KTR19 C	1/2" x 3/8"	CP	11.51

**Integral Shut-Off Stops**

Less Lock Shield Screwdriver Slot  
(Female Sweat x Male Sweat)



- For diverters and shower mixing valves

Part #	Mfg #	Nom x Nom	Finish	Price
1138	DRS44M R	1/2" x 1/2"	RB	21.06

**Stop Components for Multi-Turn Stops**

Part #	Mfg #	Description	Price
12008	R15-5	Rubber Bibb Washer	0.89

**Lavatory/Sink Supply Kits**

**Lavatory Angle Stop Supply Kits (Sweat x Comp)**

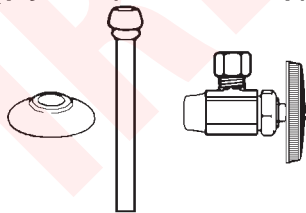

Part #	Mfg #	Nom x OD x Length	Finish	Price
11886	R1912A C	1/2" x 3/8" x 12"	CP	46.92
11887	R1912A R	1/2" x 3/8" x 12"	RB	41.45

**Lavatory Angle Stop Supply Kits  
(5" Sweat Extension x Comp)**



Part #	Mfg #	Nom x OD x Length	Finish	Price
11881	CS400A C	1/2" x 3/8" x 12"	CP	52.12

**Lavatory/Sink Supply Kits (Continued)**

**Lavatory Angle Stop Supply Kits  
(5" Sweat Extension x Comp)**

Part #	Mfg #	Nom x OD x Length	Finish	Price
11882	SCS400A C*	1/2" x 3/8" x 12"	CP	63.69

\* Loose Key

**Closet Supply Kits**

**Closet Angle Stop Kit (5" Sweat Extension x Comp)**



Part #	Mfg #	Nom x OD x Length	Finish	Price
11878	CS401DL C	1/2" x 3/8" x 12"	CP	27.72

**Lavatory/Sink Risers**

- Actual riser length is length to connect less 1/2"

**Lavatory/Sink Risers - 1-Piece with Insert**



Part #	Mfg #	Size	Finish	Price
11892	1-12A C	3/8" x 12"	CP	5.50
11897	1-20A C	3/8" x 20"	CP	8.27
11903	1-30A C	3/8" x 30"	CP	19.44
11905	1-36A C	3/8" x 36"	CP	22.92
11906	3-12A C	1/2" x 12"	CP	12.95
11908	3-20A C	1/2" x 20"	CP	18.56
11894	1-12A R	3/8" x 12"	RB	4.99
11899	1-20A R	3/8" x 20"	RB	8.07
11902	1-30A R	3/8" x 30"	RB	14.75
11904	1-36A R	3/8" x 36"	RB	18.02
11907	3-12A R	1/2" x 12"	RB	10.01
11909	3-20A R	1/2" x 20"	RB	15.00
11910	3-30A R	1/2" x 30"	RB	21.71

**Lavatory/Sink Risers (Comp)**



Part #	Mfg #	OD x Length	Finish	Price
11900	1-20KC C	3/8" x 20"	CP	19.06
11912	1-12KC R	3/8" x 12"	RB	11.31
116895	1-20KC R	3/8" x 20"	RB	17.66

Plumbing



# Plumbing Valves, Supplies & Connectors



## Lavatory/Sink Risers (Sweat)



Part #	Mfg #	OD x Length	Finish	Price
11896	1-12KA R	3/8" x 12"	RB	7.07
11901	1-20KA R	3/8" x 20"	RB	11.14

## Lavatory/Sink Risers (Sweat) - 1-Piece

- With shank nut and 1/2" nominal sweat inlet



Part #	Mfg #	OD x Length	Finish	Price
11913	CS600 R	1/2" x 12"	RB	12.16

## Closet Risers

### Closet Risers (Gasket Nosepiece)



Part #	Mfg #	OD x Length	Finish	Price
11888	1-12DL C	3/8" x 12"	CP	6.15
11890	1-20DL C	3/8" x 20"	CP	12.95
11891	3-12DL C	1/2" x 12"	CP	15.47

## Nosepiece



Part #	Mfg #	Size	Price
11988	1A	3/8"	1.23

## Needle Valves & Kits

### Brass Straight Valves (Comp x Comp)

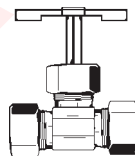

Part #	Mfg #	Size	Price
1136	NV-105-4	1/4" OD x 1/4" OD	8.61
1137	NV-105-6	3/8" OD x 3/8" OD	11.19

## Brass Needle Valve Kit - Self-Piercing

- For 3/8" to 1" OD Tube

- Includes:

- Needle valve
- Saddle clamp
- (2) Nuts
- (2) Bolts
- Washers

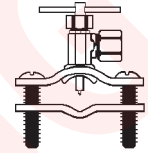

- Brass sleeve for copper tube installation
- Plastic sleeve & brass insert for plastic tube

Part #	Mfg #	Description	Price
1135	PNEV-NCV	1/4" OD Comp Tube	8.43



## Flanged Tailpieces



Part #	Mfg #	Gauge	Size	Finish	Price
14134	142	17	1-1/2" x 8"	Brass	8.54
14133	142	17	1-1/2" x 8"	Chrome	13.33
14136	144	17	1-1/2" x 12"	Brass	10.52
14135	144	17	1-1/2" x 12"	Chrome	13.44
14122	P37028	-	1-1/2" x 12"	PVC	1.47
207490	155	17	2" x 12"	Chrome	29.64

## Slip Joint Extension Pieces



Part #	Mfg #	Gauge	Size	Finish	Price
14142	7903	17	1-1/4" x 12"	Brass	19.08
14141	7903	17	1-1/4" x 12"	Chrome	19.54
14144	7906	17	1-1/2" x 12"	Brass	20.54
14143	7906	17	1-1/2" x 12"	Chrome	22.07
14151	758	17	1-1/2" x 24"	Brass	42.93
14149	757	17	1-1/4" x 24"	Chrome	39.72

## Highway Arms

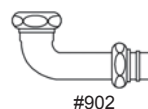

#902

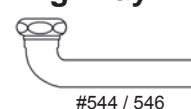

#544 / 546

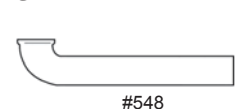

#548

Part #	Mfg #	Gauge	Size	Finish	Price
14044	902	20	1-1/4" x 8"	Chrome	21.80
14130	544	17	1-1/2" x 12"	Brass	19.17
14126	544	17	1-1/2" x 12"	Brass	23.78



# Plumbing Valves, Supplies & Connectors



Plumbing

## Highway Arms (Continued)

Part #	Mfg #	Gauge	Size	Finish	Price
136565	546	17	1-1/2" x 15"	Brass	26.42
14129	548	17	1-1/2" x 24"	Brass	34.20
14128	548	17	1-1/2" x 24"	Chrome	37.76

## Scratch Threaded Tailpieces & Overflows



Part #	Mfg #	GA	Size	Finish	Thrd	Price
14146	1773	17	1-1/4" x 12"	BR	TBE	11.39
14145	1773	17	1-1/4" x 12"	CP	TBE	14.08
14148	1776	17	1-1/2" x 12"	BR	TBE	12.88
14147	1776	17	1-1/2" x 12"	CP	TBE	13.61
14042	803	17	1-1/2" x 1-1/4" x 8"	CP	TOE	20.22
14041	1162	20	1-3/8" x 12"	BR	TBE	11.01
18349	1323012	17	1" x 10"	BR	TBE	8.74
18350	1323004	17	1" x 1-1/8" x 10"	BR	TBE	8.32

## Extension Pieces



Part #	Mfg #	Gauge	Size	Finish	Price
14138	787	17	1-1/4" x 12"	Brass	Call
14137	787	17	1-1/4" x 12"	Chrome	17.37
14140	789	17	1-1/2" x 12"	Brass	12.28
14139	789	17	1-1/2" x 12"	Chrome	13.83

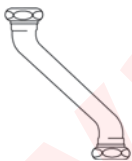



## Double Offsets

Part #	Mfg #	Gauge	Size	Finish	Price
14154	7037	17	1-1/4"	Brass	26.92
14153	7037	17	1-1/4"	Chrome	27.08
14156	7038	17	1-1/2"	Brass	25.27
14155	7038	17	1-1/2"	Chrome	28.82

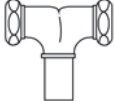
## Elbows & Tees

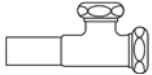
- 

**#538**  
Cast tee with tailpiece, nuts, and washers- center outlet
- 

**#2185**  
Cast tee with Tailpiece, Nuts & Washers - End Outlet
- 

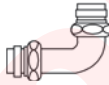
**#674**  
Repair fitting - 90 degrees, with nuts and washers
- 

**#779**  
Tank elbow, nuts, and washers
- 

**#47SN**  
For rubber hose clamp or 3/4" sweat connection

**#47SSN**  
For 1/2" copper tube sweat connection

Part #	Mfg #	Gauge	Size	Finish	Price
14160	538	-	1-1/2"	Brass	32.28
14158	2185	-	1-1/2"	Brass	25.08
14163	47S	-	1-1/2" x 1/2"	Crass	19.44
14164	47SSN	-	1-1/2" x 3/4"	Brass	25.13
14048	779	-	2" x 6" x 8"	Chrome	53.49
877652	674	-	1-1/2"	Chrome	17.31

## Cover Tubes



Flanged Bell Cover Tube  
#1041



Cover Tube  
#1045 / #T73

Part #	Mfg #	Gauge	Size	Finish	Price
14051	1041	-	2" x 6"	Chrome	15.45
14052	1045	-	2" x 6"	Chrome	18.69
855087	T73	-	1-3/8" x 3'	Chrome	34.89
224829	T73	-	2" x 3'	Chrome	47.55
227986	T73	-	1-3/4" x 3'	Chrome	39.54



## Tubular Brass

### Service Sink Accessories

#### Trap Standard

- Cast iron body with white coating
- Chrome plated brass strainer



Part #	Mfg #	Size	Price
209631	T00-003	3" IPS	173.30



#### Brass Plugs

#### Brass Tubular C. O. Plugs - 1-Piece



Part #	Mfg #	Ga	Size	Finish	Price
14054	681PC	22	1-1/4" x 5"	PC	13.53

### Specialty Strainers

Part #	Mfg #	Description	Price
14063	1377PC	Wide Flange Strainer for 3-1/2" Hole w/Brass Body, CP	24.65



### Brass P-Traps

#### Cast Brass Ground Joint Swivel P-Traps

- LA Style
- Includes cast brass ground joint elbow and cast brass slip nuts
- Polished chrome
- 17 Gauge
- 5" Height

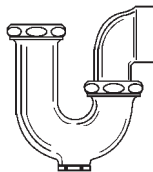

Part #	Mfg #	Size	Price
35993	8090C	1-1/4" x 1-1/2" IPS Outlet	42.19

### Cast Body Boston Traps with Cleanout Plug

- 2" Minimum water seal
- Includes cast brass slip nuts, heavy 17 gauge brass sweat extension, chrome plated steel bell flange
- Polished chrome

Part #	Mfg #	Size	Extension	Price
13950	8090CBOS6CP	1-1/4" x 1-1/2"	6"	43.11

### Brass Nipples

#### Heavy Brass Nipple with Heavy Brass Set Screw Flange

- For use with ground joint swivel traps and NY Reg traps

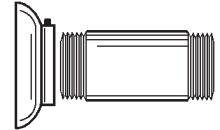

Part #	Mfg #	Size	Finish	Price
13948	2127C	1-1/2" x 6"	CP	38.41

### Flexible Supply Kits

#### Commercial Grade Lavatory Supplies (IPS x Comp)

- 12" Flexible chrome plated riser with (2) chrome plated steel flanges
- Includes (2) chrome plated solid brass angle stops with round wheel handles, all brass stems & replaceable high tech purple washers
- LK Designates loose key

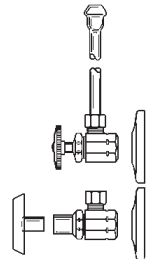

Part #	Mfg #	IPS x OD	Price
13938	165	3/8" x 3/8"	17.44
13939	165-LK	3/8" x 3/8"	19.45
37688	167-LK	3/8" x 1/2"	36.40
13949	2165-LK	1/2" x 3/8"	23.50

#### Commercial Grade Lavatory Supplies with Extension Tube (Sweat x Comp)

- 5" Flexible chrome plated copper extension tube
- 12" Chrome plated riser with (2) chrome plated steel flanges
- Includes (2) chrome plated solid brass angle stops with round wheel handles, all brass stems & replaceable high tech purple washers

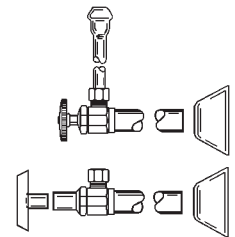

Part #	Mfg #	Sweat x OD	Price
13942	170	1/2" x 3/8"	31.35
13943	170-LK	1/2" x 3/8"	34.98



## Tubular Brass

Plumbing

### ADA Wheelchair Lavatory Supplies (IPS x COMP)

- Includes (2) 3/8" straight chrome plated loose key stops with stuffing box, 3/8" x 1-1/2" & 3/8" x 6-1/2" chrome plated nipples, reducers, elbows & shallow steel flanges chrome plated

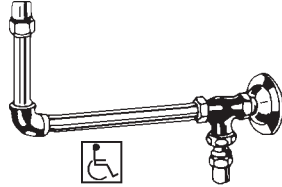

Part #	Mfg #	Description	Price
13937	158WC	3/8" IPS with 3/8" x 1/4" Reducer	89.27

### Premier Line Heavy Lavatory Supplies (IPS x COMP)

- 12" Flexible chrome plated riser with (2) chrome plated steel flanges
- Includes (2) highly polished chrome plated heavy-duty brass angle stops with round wheel handles, all brass stems & replaceable high tech purple washers

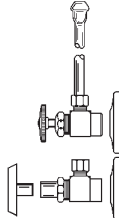

Part #	Mfg #	IPS x OD	Price
111080	H165	3/8" x 3/8"	39.15
35990	H165LK	3/8" x 3/8"	44.88

### Premier Line Heavy Lavatory Supplies with 5" Extension Tube (Sweat x COMP)

- 5" Flexible chrome plated copper extension tube
- 12" Flexible chrome plated riser with (2) chrome plated steel flanges
- Includes (2) highly polished chrome plated heavy-duty brass angle stops with round wheel handles, all brass stems & replaceable high tech purple washers
- LK Designates loose key

Part #	Mfg #	Sweat x OD	Price
35991	H170LK	1/2" x 3/8"	66.72

### Commercial Grade Closet Supplies (Sweat x Comp)

- 5" Chrome plated copper extension tube
- 12" Flexible chrome plated riser with (1) chrome plated steel flanges
- Includes (1) chrome plated solid brass angle stop with round wheel handle, all brass stems & replaceable high tech purple washers

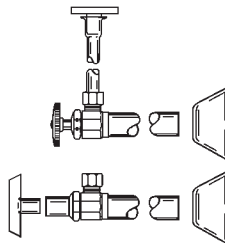

Part #	Mfg #	Sweat x OD	Price
13946	172	1/2" x 3/8"	16.89

### Flanges

#### Heavy Brass Set Screw Flanges

Part #	Mfg #	Size	Finish	Price
47183	127050P	1/2" IPS	Pol Brass	10.42

### Stops

#### Premier Line Heavy Duty Angle (Sweat x Comp)

- 5" Copper extension

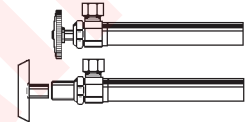

Part #	Mfg #	Sweat x OD	Price
13957	HST082	1/2" x 3/8"	23.72

#### Premier Line Heavy Angle (IPS x Comp)

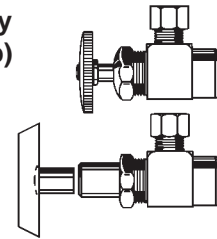

Part #	Mfg #	IPS x OD	Price
13953	HST01	3/8" x 3/8"	14.67

#### Premier Line Heavy Angle (Comp x Comp)

Part #	Mfg #	Nom x OD	Price
13958	HST09	1/2" x 3/8"	17.97





## Lavatory Accessories



### Lav Guard®2 E-Z Pipe Covers

- #100 E-Z Series designed to fit all tubular P-trap assemblies
- Built-in E-Z grip internal fasteners E-Z Tear-to-fit trimming
- Includes:
  - (1) P-Trap cover
  - (2) Angle valve and supply covers
  - (1) 5" Offset tailpiece wheelchair strainer cover



Plumbing

Part #	Mfg #	Description	Price
238471	103EZ	White, Soft, Resilient Molded Vinyl	54.50



### Nuts and Washers Metal Slip-Joint Nuts



Part #	Mfg #	IPS x Slip Tube	Finish	Price
14069	T78-125	1-1/4"	CP Brass	3.00
14075	T78-150	1-1/2" x 1-1/2"	CP Brass	1.87
14071	T78-151	1-1/2" x 1-1/4"	CP Brass	2.17
14079	T78-152	2" x 1-1/2"	CP Brass	2.92
14077	T78-200	2" x 2"	CP Brass	2.27

### Sure Grip Escutcheons Low Pattern - Copper Tube Size

- Chrome-plated steel



Part #	Mfg #	Size	Flange OD	Price
14092	E01-050	1/2" CTS (5/8" OD)	2-1/2"	0.68
14093	E01-075	3/4" CTS (7/8" OD)	2-1/2"	1.40
14094	E01-150	1-1/2"CTS (1-5/8"OD)	2-7/8"	1.40
14081	E02-375	3/8" IPS	2-1/2"	0.68
14082	E02-050	1/2" IPS	2-1/2"	0.68
14086	E02-075	3/4" IPS	2-1/2"	1.11
14087	E02-100	1" IPS	2-7/8"	0.65
14088	E02-125	1-1/4" IPS	2-7/8"	0.69
14089	E02-150	1-1/2" IPS	3"	1.58
14091	E02-200	2" IPS	3-1/2"	2.41



## Custom Reporting

Need a year's worth of your purchase history? No problem! Our custom reporting capabilities allow us to get you the information you need – quickly.



## Slipnuts, Flanges & Escutcheons

Plumbing

### Low Pattern - Tubular

- Chrome-plated steel



Part #	Mfg #	Size	Flange OD	Price
14084	E03-150	1-1/2" Tubular	2-7/8"	0.65

### Box Pattern - Tubular

- Chrome-plated steel



Part #	Mfg #	Size	Flange OD	Price
14103	E04-125	1-1/4"	3"	4.06
14104	E04-150	1-1/2"	3"	4.06
14102	E04-200	2"	3"	2.69

### Bell Pattern - Copper Tube Size

- Chrome-plated steel



Part #	Mfg #	Size	Flange OD	Price
14099	E07-050	1/2" CTS (5/8" OD)	2-3/8"	1.68

### Bell Pattern - Iron Pipe Size

- Chrome-plated steel



Part #	Mfg #	Size	Flange OD	Price
14101	E06-050	1/2" IPS	2-3/8"	1.68
14100	E06-375	3/8" IPS	2-3/8"	0.95

### Escutcheons

#### Chrome-Plated Steel Low Escutcheons



Part #	Mfg #	Size	OD	Price
14090	1611012	2" OD Copper	3"	1.80

### Nuts

#### Solid Brass Slipnuts



Part #	Mfg #	Size	Price
14070	0903002	1-1/4" x 1-1/4"	2.79
14076	0903004	1-1/2" x 1-1/2"	1.61

### Nuts (Continued)

#### Solid Brass Slipnuts

Part #	Mfg #	Size	Price
14072	0903006	1-1/2" x 1-1/4"	2.42

### Flanges

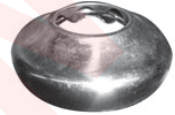

Part #	Mfg #	Description	Price
14083	R398	1-1/4" OD CP Shallow Flange	1.11

### Floor & Ceiling Plates

- Chrome plated



#### Heavy Gauge with Springs - Copper Tube Size

Part #	Mfg #	Size	Price
12612	1731002	3/8" CTS	4.22
12613	F03-050	1/2" CTS	3.78
12614	F03-075	3/4" CTS	4.00
12615	F03-100	1" CTS	6.52
12616	F03-125	1-1/4" CTS	6.52
12617	F03-150	1-1/2" CTS	7.78
12618	F03-200	2" CTS	9.90
12619	F03-250	2-1/2" CTS	17.48
12620	F03-300	3" CTS	21.90

#### Heavy Gauge with Springs - Iron Pipe Size

Part #	Mfg #	Size	Price
12623	F04-025	1/4" IPS	3.58
12624	F04-375	3/8" IPS	3.58
12625	F04-050	1/2" IPS	3.78
12626	F04-075	3/4" IPS	4.00
12627	1729006	1" IPS	4.22
12628	F04-125	1-1/4" IPS	4.22
12629	F04-150	1-1/2" IPS	4.42
12630	F04-200	2" IPS	5.90
12631	F04-250	2-1/2" IPS	8.64
12632	F04-300	3" IPS	9.48
12633	F04-350	3-1/2" IPS	19.78
12634	F04-400	4" IPS	13.14
12635	F04-500	5" IPS	35.16
12636	F04-600	6" IPS	44.00

Prices & specifications are subject to change.



# Bolts, Nuts, Screws & Washers

Radiator Specialty Company

## Faucet Screws Brass Bibb Screws



Part #	Mfg #	Description	Pkg Qty	Price
18355	S-552	1/2" x 8-32	144	0.32
18358	S-555	3/8" x 8-32	144	0.29

## Monel Bibb Screws



- Self-locking

Part #	Mfg #	Description	Pkg Qty	Price
18364	S-1265R	1/2" x 10-32	144	0.07

## Screw Assortments



Part #	Mfg #	Description	Pkg Qty	Price
168162	S-562R	(10) Sizes Brass Bibb	300	52.64

## O-Rings



Part #	Mfg #	OD	ID	Tube	Pkg Qty	Price
173870	R-994R	1-1/16"	15/16"	1/16"	25	4.00
18579	R-1006	1-3/16"	1-1/16"	1/16"	100	0.24

## O-Ring Assortments



Part #	Mfg #	Description	Pkg Qty	Price
18576	R-291	14 Sizes	200	18.23

## Friction Rings



- Brass

Part #	Mfg #	OD	ID	Tube	Pkg Qty	Price
18641	R-507	21/32"	25/64"	3/8"	100	0.34
18642	R-508	13/16"	11/16"	3/8"	100	0.37
18643	R-509	13/16"	25/64"	3/8"	100	12.00
18644	R-510	1-1/2"	1-17/64"	1-1/2"	100	0.40
18646	R-512	1-3/4"	1-33/64"	1-1/2"	100	0.60

## Faucet Washers

### Golden State® Flat Washers



Part #	Mfg #	Size	Pkg Qty	Price
92762	W-145	00	100	0.21
92763	W-145A	0	100	19.00
92765	W-148	1/4" L	100	9.00
92774	W-153	1/2" L	100	7.20
92777	W-156	1"	50	0.34

### Golden State® Washer Assortments



W158R

Part #	Mfg #	Description	Pkg Qty	Price
92757	W-143	Assorted Beveled	100	9.00
18562	W-158R	(10) Sizes Flat	300	42.11
18563	W-159R	(10) Sizes Flat/Beveled	200	42.11

### Golden State® "Handi-Boxes"



Part #	Mfg #	Description	Pkg Qty	Price
135825	W-245	00 Flat	25	7.20
135829	W-248	1/4" Flat	25	7.20
134989	W-257	Assorted Flat	25	8.00

## Faucet Washers



Part #	Mfg #	Size	Price
18566	W-376	00	0.17
18567	W-377	0	0.20

## Polyethylene Slip-Joint Washers



W571P-W572



W-574P

Part #	Mfg #	Size	Pkg Qty	Price
18534	W-571P	1-1/4"	100	0.21
18544	W-572P	1-1/2"	100	0.21

Prices & specifications are subject to change.

We offer a variety of GREEN products such as flush valves, faucets, showerheads & more!



## Bolts, Nuts, Screws & Washers

Plumbing

### Faucet Washers (Continued)

#### Polyethylene Slip-Joint Washers

Part #	Mfg #	Size	Pkg Qty	Price
18545	W-574P	1-1/2" x 1-1/4"	100	0.21

#### Flanged Plastic Tailpiece Washer (High Hat)



Part #	Mfg #	Size	Pkg Qty	Price
18543	W-573P	1-1/2"	100	0.21

#### Square-Cut Slip-Joint Washers

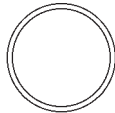

Part #	Mfg #	Size	Pkg Qty	Price
18535	W-520	1-1/4" M	100	0.16
18536	W-522	1-1/2" M	100	0.12
18537	W-523	2"	-	0.20
18541	W-536	1-3/8"	-	0.34
18540	W-535	1-1/4" x 1-1/2"	100	0.24
18539	T79-200	2" x 2"	100	0.17

#### Mack Basin Sink & Bath Gaskets

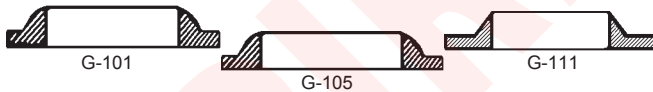

Part #	Mfg #	Description	Pkg Qty	Price
18555	G-101	1-1/4" Washer	12	1.20
18556	G-105	1-1/2" Washer	12	0.92
18557	G-111	1-1/4" Gasket	12	0.81

#### Sink Connection Washers

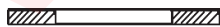

Part #	Mfg #	Size	Pkg Qty	Price
18550	W-831	1-3/4" x 1-5/16" x 1/8"	100	0.32

### Beveled (Cone) Slip-Joint Washers



W-502

Part #	Mfg #	Hold	OD	Ht	Pkg Qty	Price
18546	W-500	1/2"	27/32"	7/16"	100	0.90
18547	W-502	3/8"	23/32"	3/8"	100	0.24
18549	W-510	5/16"	27/32"	3/8"	100	0.24

### Cloth Inserted Hose Washers



Part #	Mfg #	Size	Pkg Qty	Price
115129	W-459	5/8" x 3/4"	100	0.18



## Join our e-mail newsletter!

Receive special deals and promotions, new product announcements, contests and more in your inbox every month!

Prices & specifications are subject to change.



## Sink Strainers



### Kitchen Strainers

#### Basket Strainers



LK-99  
LK-335

LK-35

LK-35L

**ELKAY**



THE BOLD LOOK OF  
**KOHLER**  
K-8801-CP



QUALITY DESIGNED  
**KEENEY**  
PRODUCTS  
151-A

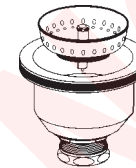

**The Keeney**  
Manufacturing Company  
2443PCBN

Part #	Mfg #	Drain Opening	Top Diameter	Body Finish	Tailpiece Size	Tailpiece Finish	Price
12531	LK-99	3-1/2"	4-1/2"	Stainless Steel	1-1/2"	Chrome/Brass	66.50
12529	LK-35	3-1/2"	4-1/2"	Stainless Steel	1-1/2"	Chrome/Brass	41.23
33994	LK-35B	3-1/2"	4-1/2"	Stainless Steel	1-1/2"	Stainless Steel	53.86
33995	LK-35L	3-1/2"	4-1/2"	Stainless Steel	1-1/2" OD 90-Elbow	Chrome/Brass	76.47
12532	LK-335	3-1/2"	4-1/2"	316 Stainless Steel	1-1/2"	316 Stainless Steel	109.05
13699	K-8801	3-1/2" - 4"	4-1/2"	Chrome/Brass	1-1/2"	Chrome/Brass	48.21
13934	151A	3-1/2"	4-3/8"	Chrome/Brass	1-1/2"	Chrome/Brass	24.99
856639	2433PCBN	3-1/2"	4-1/2"	Chrome/Brass	1-1/2"	Chrome/Brass	23.58

#### Fit-All Strainer Basket

- Stainless steel with metal post
- Fit-all strainer basket



Part #	Mfg #	Description	Price
14065	2104M	Fit-all strainer basket assembly - stainless steel with metal post	8.25

#### Grid Strainers

- 3-1/2" Drain Opening
- 1-1/2" Tailpiece
- 4-1/2" Top Diameter
  - LK-18: Chrome Plated Brass
  - LK-18B: Stainless Steel
  - LK-372: 316 Stainless Steel



Part #	Mfg #	Drain Opening	Top Diameter	Body Finish	Tailpiece Size	Tailpiece Finish	Price
12527	LK-18	3-1/2"	4-1/2"	Chrome/Brass	1-1/2"	Chrome/Brass	35.25
36267	LK-18B	3-1/2"	4-1/2"	Stainless Steel	1-1/2"	Stainless Steel	42.56
33997	LK-372	3-1/2"	4-1/2"	316 Stainless Steel	1-1/2"	316 Stainless Steel	105.73

### Bar Sink Strainers & Tray Plugs

#### Bar Sink Strainers



LK-36 LK-8

**ELKAY**



1377PCB



877PCBN



1370-BN



1371-BN

Part #	Mfg #	Drain Opening	Top Diameter	Body Finish	Tailpiece Size	Tailpiece Finish	Price
12530	LK-36	2"	2-7/8"	Chrome/Brass	1-1/2"	Chrome/Brass	46.55
12526	LK-8	2"	2-13/16"	Chrome/Brass	1-1/2"	Chrome/Brass	43.65

Prices & specifications are subject to change.

Our state of the art pipe shop offers cutting, threading, grooving and make-ons up to 36in!



# Sink Strainers

## Bar Sink Strainers & Tray Plugs (Continued)

### Bar Sink Strainers

Part #	Mfg #	Drain Opening	Top Diameter	Body Finish	Tailpiece Size	Tailpiece Finish	Price
861015	877PCBN	2"	2-7/8"	Chrome/Brass	1-1/2"	Chrome/Brass	19.49
14063	1377PCBN	3"	4-1/2"	Chrome/Brass	1-1/2"	Chrome/Brass	24.65
919777	1370-BN	2" - 2-1/2"	2-7/8"	Chrome/Brass	1-1/2"	Chrome/Brass	9.56
919778	1371-BN	2" - 2-1/2"	2-7/8"	Chrome/Brass	1-1/2"	Chrome/Brass	9.56

### PO Plug & Grid Drains



Part #	Mfg #	Drain Opening	Top Diameter	Body Finish	Tailpiece Size	Tailpiece Finish	Price
13935	155-A	1-1/4"	2-1/4"	Chrome/Brass	1-1/4" x 6"	Chrome/Brass	19.04
13936	155-WC	1-1/4"	2-1/4"	Chrome/Brass	1-1/4" x 8-1/8"	Chrome/Brass	35.71
14056	760-1	1-1/4"	2-3/16"	Chrome/Brass	1-1/4" x 6"	Chrome/Brass	13.64
14055	D70-103	1-1/4"	2-1/8"	Chrome/Brass	1-1/4" x 5"	Chrome/Brass	16.34
36817	LK-174	1-1/2" - 1-5/8"	2-1/4"	Chrome/Brass	1-1/4" x 6"	Chrome/Brass	62.69

### One-Touch Lav Drains & Pop-up Drains



Part #	Mfg #	Drain Opening	Top Diameter	Body Finish	Tailpiece Size	Tailpiece Finish	Price
896653	30-05PC	For vessel lavs without overflow					49.10
896654	30-06PC	For vessel lavs with overflow					30.45
21597	RP5651	Metal pop-up drain					48.82
12763	43-973	Metal pop-up drain					43.23

### Commercial Kitchen Drains

#### Lever Wastes



Part #	Mfg #	Sink Opening	Drain Outlet	Flange Outlet	Strainer/Flange	Body Material	Price
12737	100-1034	3"	2"	4-1/8"	Stainless Steel	Nickel Plated Brass	88.60

Prices & specifications are subject to change.



# Sink Strainers



## Commercial Kitchen Drains (Continued) Lever Wastes

Part #	Mfg #	Sink Opening	Drain Outlet	Flange Outlet	Strainer/Flange	Body Material	Price
12738	100-1035	3-1/2"	2"	4-3/8"	Stainless Steel	Nickel Plated Brass	88.60

### Lever Wastes with 1-1/4" Overflow Outlet

Part #	Mfg #	Sink Opening	Drain Outlet	Flange Diameter	Strainer/Flange	Body Material	Price
12739	100-1036	3-1/2"	2"	4-3/8"	Stainless Steel	Nickel Plated Brass	95.12
12740	100-1037	3-1/2"	2"	4-3/8"	Stainless Steel	Nickel Plated Brass	87.80

## Commercial Kitchen Drains Accessories / Parts



100-1042  
Reducer Coupling



142-1113  
Waste Flange Tool



102-1007  
Cast Drain Assembly

Part #	Mfg #	Description	Price
12744	100-1042	2" FNPT to 1-1/2" MNPT Reducer Coupling; Nickel Plated Brass	26.80
12747	142-1113	For removing or installing lever and twist wastes with 2-3/4" or 3-1/8" slots	48.34
12745	102-1007	Brass heavy cast drain assembly; includes lock nut and washer	17.82

## Specialty Sink Drains Epoxy Resin Sink Outlet



- Includes a plastic disc strainer

Part #	Mfg #	Description	Price
7864	SO3	1-1/2" PO Plug	46.00

## Orion Acid Waste Drain Assemblies

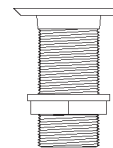

- Designed for use with Orion pipe and fittings for acid waste disposal.
- Please see our other Orion acid waste products.

Part #	Mfg #	Description	Price
54160	WA1	1-1/2" IPS Waste Assembly - 2.5 DIA Top - Use RLNS Adapter	26.70
114527	WA2	1-1/2" IPS Waste Assembly - 3.4 DIA Top - Use RLNS Adapter	29.26
114529	WA3	1-1/2" IPS Waste Assembly - 4.25 DIA Top - Use RLNS Adapter	37.17

## Shower & Floor Drains Solid Heavy-Duty Shower Drains



6410



6420



49871



Part #	Mfg #	Size	Description	Price
200994	6410	2" Caulk	1-3/8" Barrel with Stainless Steel Grate	54.29
200999	6420	2" IPS	1-3/8" Barrel with Stainless Steel Grate	54.29
201000	6425	2" IPS	2-1/2" Barrel with Stainless Steel Grate	58.15

Prices & specifications are subject to change.

Metropolitan Pipe offers FREE DELIVERY in the Greater Boston area.



## Sink Strainers

Plumbing

### Shower & Floor Drains (Continued)

#### Solid Heavy-Duty Shower Drains

Part #	Mfg #	Size	Description	Price
201001	6430	2" Sweat	1-3/8" Barrel with Stainless Steel Grate	54.29
911767	49871	2" x 3" PVC	Low Profile Adjustable, Brass Barrel, Heavy Brass Square Grate	52.50

#### Shower/Urinal Strainers

- Chrome Plated Brass
- Urinal Strainer



0521002



0530002



Part #	Mfg #	Size	Description	Price
18385	0521002	2" IPS	Chrome Plated Brass Urinal Strainer	32.84
18386	0521004	2" DWV	Chrome Plated Brass Urinal Strainer	32.84
18388	0530002	3-1/2"	Chrome Plated Brass Urinal Strainer / Shower Stall Grid	1.26

#### Shower Drain (For Plastic Pipe)

- This KOHLER shower drain features solid brass construction for durability and reliability.
- Resistant to clogs and buildups, it includes a connection gasket and is intended for installations with 2" outlets.
- Perforated strainer shower drain

THE BOLD LOOK  
OF KOHLER.



Part #	Mfg #	Size	Description	Price
13730	K-9132-CP	2"	Chrome Plated Shower Drain (For Plastic Pipe)	56.47
13731	K-9132-PB	2"	Polished Brass Shower Drain (For Plastic Pipe)	94.53

#### Shower Stall Drains



D41-001



D40-101



D40-102

Part #	Mfg #	Size	Description	Price
18387	D41-001	2"	Shower Stall Drain for Schedule 40 PVC Pipe	8.66
114276	D40-101	2"	Shower Stall Drain for Schedule 40 PVC Pipe, No Caulk, Gasket & Wrench Included	8.85
115261	D40-102	2"	Inside Caulk Shower Stall Drain for Schedule 40 PVC or Cast Iron Pipe	16.91

#### Accessories

Part #	Mfg #	Description	Price
860096	D40-008	Copper Tube Size (CTS) Gasket for D40-101 Strainer	8.29
892569	D41-10BN	Brushed Nickel Strainer for D41-001	23.96

### Cast Iron Drain Covers

#### Jumbo Drain Covers Light Cast Iron



Part #	Mfg #	Size	Price
922879	663	4-7/8"	25.20

Prices & specifications are subject to change.





## Sink Strainers



### Cast Iron Drain Covers (Continued)

#### Jumbo Drain Covers Light Cast Iron

Part #	Mfg #	Size	Price
922880	663A	5"	22.92
917153	664A	5-1/2"	26.44
922881	665A	5-7/8"	27.36
862929	665B	6"	29.64
922887	666A	6-1/2"	30.96
916402	667B	6-3/4"	31.96
922882	669	6-7/8"	31.96
865598	669C	7-1/4"	46.36
922883	671	7-7/8"	49.96
856892	671A	8"	49.96
812020	672B	8-5/8"	57.32
858596	673	9"	57.32
922884	673C	9-1/2"	62.88
922886	675A	9-7/8"	62.88

## GERBER.

### Brass Drains

#### Pop-Up Brass Drains

- Pre-adjustable linkage
- Fits most tubs 14" to 16"
- Roman fits most tubs 24"
- Chrome-plated



Part #	Mfg #	Description	Price
12752	41-801	Fit-All Drain in Shoe, 17ga, Brass Nuts	92.70
12754	41-806-91	Fit-All Drain in Shoe, 20ga, Brass-Plated Zinc Nuts	80.90
12755	41-807	Fit-All Side Outlet, 20ga, Brass-Plated Zinc Nuts	87.88

#### Trip Lever Brass Drains

- Pre-adjustable linkage
- Fits most tubs 14" to 16"
- Roman fits most tubs 24"
- Chrome-plated



Part #	Mfg #	Description	Price
12756	41-812	All-Tub Drain in Tee, 17ga, Brass Nuts (Gerber)	72.71
900769	1430G17	All-Tub Drain in Tee, 17ga, Brass Nuts (American Brass)	61.67

### Brass Drains (Continued)

#### Trip Lever Brass Drains

Part #	Mfg #	Description	Price
12757	41-813	Roman, 9" Shoe, 17ga, Brass Nuts (Gerber)	86.24
888111	1430G17	Roman, 9" Shoe, 17ga, Brass Nuts (American Brass)	71.67
12758	41-818-91	All-Tub Drain in Tee, 20ga, Brass-Plated Zinc Nuts (Gerber)	70.75
232774	1430G20	All-Tub Drain in Tee, 20ga, Brass-Plated Zinc Nuts (American Brass)	56.67

### Drain Exposed Parts Trim Kits

#### Trip Lever Trim Kit

- Lever/Faceplate
- (2) 2-1/4" Faceplate screws
- Strainer with screw



Part #	Mfg #	Finish	Price
40335	86-867	Polished Brass	45.23



### Drain Bodies

#### "Code Blue" No-Hub Drain Bodies

- Tapped for 3-1/2" spud
- 1/2" Primer tapped with brass plug
- Supplied with stainless steel bolts



Part #	Mfg #	Size	Pan	Price
213260	D65-102	2"	7"	48.63
213261	D66-103	3"	9"	67.11
213262	D66-104	4"	9"	67.11

#### No-Hub Base

- Use with CI strainers or covers for heavy trucking traffic
- Use with PB, NB, SS or CP strainers and covers for heavy pedestrian traffic
- 4-1/4" Height



Part #	Mfg #	No Hub Base x Spud	Price
922349	D63-349	3" NH Base for 3-1/2" IPS Spud	11.60
922350	D63-350	4" NH Base for 3-1/2" IPS Spud	19.14

Prices & specifications are subject to change.

Metropolitan Pipe offers Vendor Managed Inventory - never run out of that part again!



## Drains, Wastes, Cleanouts & Strainers

Plumbing

### Gasket Connection Base

- Supplied with Multi-Tite gasket
- Use with CI strainers and covers for heavy trucking traffic
- Use with PB, NB or CP strainers and covers for heavy pedestrian traffic
  - -349: 5-1/4" Height
  - -350: 5-1/2" Height



Part #	Mfg #	S.V. Base x Spud	Height	Price
922351	D62-349	3" SV Base for 3-1/2" IPS Spud		20.42
922353	D62-350	4" SV Base for 3-1/2" IPS Spud		35.05

### Drain Cleanout Spuds

**3-1/2" Metal Spud  
with 5" Square Strainer**

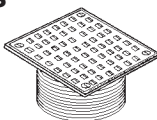

Part #	Mfg #	Strainer	Price
213255	D60-962	NB Square	67.43

### 3-1/2" Cast Iron Spuds and Strainers for Drain Bodies

- Tailpieces are cast brass
- For use with heavy duty floor drains

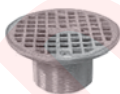

Part #	Mfg #	Strainer	Price
213253	D60-996	5" NB Cover	65.68

### Cleanout Spuds

**3-1/2" IPS Metal Spuds  
with 5" Round Covers**

- Supplied with 3-1/2" IPS countersunk plug

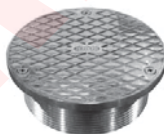

Part #	Mfg #	Description	Price
922347	C37-810	5" Brass Cover	102.17



### Aerators

**Spring-Flo® Aerators**

- 3-Screen slotted aerator



Part #	Mfg #	Description	Quantity	Price
18402	171-4	Small Male	1/Pk	2.60
237001	171-4	Small Male	50/Pk	2.59

### Additional Aerators

Part #	Mfg #	Description	Price
156485	620	Tap End 1.5 GPM Slotless	1.28
237003	101-4	15/16m Slotted Aerator Lg-Male	3.00



### Faucet Accessories

#### Combo Aerator to Male Garden Hose Adapter

- Nickel-plated brass

Part #	Mfg #	Description	Price
18434	2313005	15/16" Dual Aerator Thread to 3/4" Male Garden Hose	3.16

#### Imported Combination Aerators

- Fits both male and female conventional threads

Part #	Mfg #	Description	Price
18405	2305004	Regular 15/16", Chrome-Plated	1.58



### Ice Maker Water Supply

#### PEX Water Supply Tubing Kit

- Includes all necessary hardware for installation



Part #	Mfg #	Description	Price
17980	34015	25' x 1/4" OD Polyethylene Tubing	16.31



### Ice Maker Connectors (Comp x Comp)

- Sleeve packaged



Part #	Mfg #	Length	Fittings	Price
162187	12IM120	120"	1/4" x 1/4"	20.96



## Shower Accessories



### Chloroloy® 240 Shower Pan Liner

- Made from durable CPE (chlorinated polyethylene)
- Absolute waterproofing - lowest permeability
- Lifetime guarantee

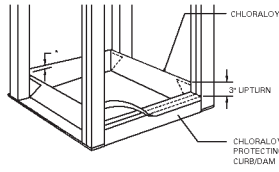

Part #	Mfg #	Description	Price
12217	240	5' x 40' Roll	3.55

### Preformed Dam Corners

- Protects against water leakage at the junction of the shower opening and the dam

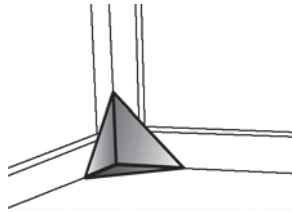

Part #	Mfg #	Description	Price
197214	240-CORNER	Inside Corner	7.70

### Nobleweld 100 Cement

- Chemically fuses (2) sheets of Noble sheet membranes
- Provides permanent, watertight seal

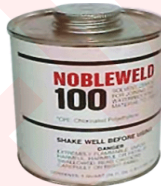

Part #	Mfg #	Size	Price
12218	NOBLEWELD100	1 pt	18.81



### Bathtub Protectors

- Offers protection against tub damage during home construction
- Semi-flexible heavy high-impact plastic with deep-fluted sidewall
- Includes a non-skid foam pad to absorb shock and prevent scratched and dented tub finish
- Nests for space-saving storage

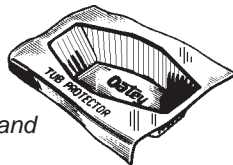

Part #	Mfg #	Description	Price
949013	34125	14 - 16" Multi-size adjustable bath tub protector	16.90

## Chatham

### Shower Arms

- Full weight, full thread
- Solid brass
- .064 Wall, polished before plating, tapered thread and chambered ends



Part #	Mfg #	Description	Price
18393	6F	6" Rigid Shower Arm & Flange, CP	7.01



### Shower Rods

#### Aluminum Shower Rods

- 1" OD - .025 Wall



Part #	Mfg #	Size	Pkg Qty	Price
14108	S02-055	5'	50	3.84



### Shower Accessories

#### Straight Shower Rods with Wrought Flange

Part #	Mfg #	Size	Finish	Price
204015	1837PC	1" x 5'	Brass PC	36.76

#### Shower Rods Less Flange

Part #	Mfg #	Size	Material	Price
211177	1845ALLF	1" x 5'	Aluminum	6.62
208927	1847ALLF	1" x 6'	Aluminum	4.39

### Shower Rod Flanges

- "Jiffy" Adjustable

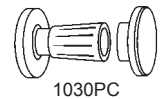

Part #	Mfg #	Description	Finish	Price
208928	1030PC	Plastic	Chrome	2.59
204017	1031PC	Die-Cast	Chrome	7.06

Prices & specifications are subject to change.

Our faucet parts counter is one of the largest in the Boston area with thousands of parts in stock!



## Tub & Shower Accessories

Plumbing

### Decorative Strainers

#### Strainer with Screws for Fiberglass Shower Stalls

- Fits D41-001 & D41-600
- Tapping screws included



Part #	Mfg #	Description	Price
892569	D41-10BN	4-1/4" Diameter, Brushed Nickel	23.96

### Basin & Tub Drain Stoppers

#### Hollow Basin and Tub Stopper

- White rubber with rustproof ring



Part #	Mfg #	Size	Pkg Qty	Price
189071	P35-125	1-1/4"	25	1.25
184636	P35-150	1-1/2"	25	0.52
181593	P35-175	1-3/4"	25	0.58
189073	P35-158	1-5/8"	25	0.56

### Radiator Specialty Company

### Drain Plugs

#### Solid Basin & Bath Stoppers



Part #	Mfg #	Size	Color	Pkg Qty	Price
18513	S-210	1"	White	12	2.14
18514	S-211	1-1/8"	White	12	1.85
18515	S-212	1-1/4"	White	12	2.36
18517	S-214	1-1/2"	White	12	2.44
18518	S-215	1-5/8"	White	12	2.36
18519	S-216	1-3/4"	White	12	2.32
18521	S-218	2"	White	12	2.32



### Tub Spouts & Accessories

#### #10 Nickel-Plated Brass Beaded Chain

Part #	Mfg #	Description	Price
36450	1616006	100' Roll	0.79

### Coupling for #10 Bead Chain

Part #	Mfg #	Description	Price
36453	1617002	Type A	0.17
36454	1617004	Type B	0.13

### Grab Bars with Exposed Flanges



- 18 gauge stainless steel
- Meets 900 lb. downward pull when installed properly
- Meets federal specifications for FHA, VA hospital, private construction
- Individually bagged with stainless steel mounting screws

Part #	Mfg #	Size	Price
12974	12518CSG	18"	30.31
12975	12524CSG	24"	35.35
12977	12536CSG	36"	40.89
12978	12542CSG	42"	47.44
218501	12548CSG	48"	51.30



### Flip-It® Replacement Tub Stoppers

- Fits over 90% of all tub drain openings
- 1-Piece construction
- Unique toggle system - flip left to close, right to open



Part #	Mfg #	Description	Price
18525	P-100	Chrome-Plated, w/(5) Sets of O-Rings	11.40

QUALITY DESIGNED



PRODUCTS

### Diverter Tub Spouts

- Cast brass
- Chrome plated

Part #	Mfg #	Description	Price
39055	1222DS	1/2" or 3/4" IPS Flush Connection	40.43



## Tub Spouts

### Tub Spouts

#### Chrome Plated Tub Spout

- Includes hex key



Part #	Mfg #	Size	Conn	Material	Price
40357	D01-020	1/2" FIP	Nose	CP Zamack	14.12



### Burlington Anti-Siphon Brass Ballcock

- Flow regulator/silencer
- Pressure relief by design
- Soft, positive closure
- Fits all standard tanks
- Compact profile
- High critical level
- Limited lifetime warranty

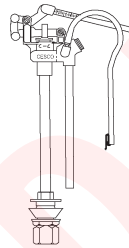

Part #	Mfg #	Description	Price
129134	20A	10" Total Height	35.60

### Douglas Brass Flush Valve

- 2-1/2" All brass
- Tank ball sold separately



Part #	Mfg #	Description	Price
18288	40B	10-5/8" Total Height	24.53

### Curtin Toilet Accessories

Part #	Mfg #	Description	Price
21407	50	Curtin Flush Valve (1-Pc Closet)	80.49
21411	120	Curtin Back Supply Ballcock	98.00
21412	160	Curtin Top Supply (Hi Tank)	68.00
21434	10-50	Curtin Seat Washer	3.01
21439	15-50	Curtin Brass Bolt & Nut Set	5.45

## Fluidmaster

### Toilet Tank Fill Valves

- Fits most toilet tanks
- Saves water
- Easy to install
- Replaces old-fashioned units
- Corrosion-resistant materials



#### Pro Series™ Fill Valve

- Heavy-duty shank manages water flow, eliminating water hammer by 99% and delivering tank refill at half the noise level of other valves
- Adjustable height for a universal fit and a float screw for fine tuning
- Extremely durable

Part #	Mfg #	Description	Price
876636	PRO45B	Anti-Siphon Fill Valve w/Brass Shank	19.98
876632	PRO45C	Anti-Siphon Fill Valve w/Adj Flapper	15.96
876635	PRO45K	Complete Kit Includes Fill Valve, Flush Valve, Bowl Gasket, Bolts, and Tank Lever	33.39

### Anti-Siphon Fill Valve

- Adjusts water level for best flush
- Anti-siphon operation - code approved
- Adjustable height 9" - 14"
- Signals water waste



Part #	Mfg #	Description	Price
18290	400A	Anti-Siphon Fill Valve	13.74

### Leak Sentry™ Pro Fill Valve

- Locking action forces users to repair leaks fast
- Anti-siphon operation - code approved
- Ideal for multi-housing applications
- Bowl refill adjustment
- Fits most toilets including 1.6 gpf
- 5-Year warranty



Part #	Mfg #	Description	Price
146625	400LS	Leak Sentry™ Pro Fill Valve	17.92



## Toilet Accessories

## Fluidmaster

### Fill Valve Repair Parts Replacement Seals



- Easy repair, extends valve life

Part #	Mfg #	Description	Price
18296	242	Seal for: Pro 45, 400A Fill Valve	1.99

### Pro Series™ PRO57 Flush Valve



- Adjustable flapper
- Kink-free stainless chain
- Ends leaks at the drain
- Fits most tanks

Part #	Mfg #	Description	Price
92106	PRO57	Flush Valve w/PRO55 Flapper, Includes bolts & gaskets	7.47
876637	PRO57K	Flush Valve w/PRO55 Flapper	15.96

### Pro Series™ Ballcocks



- Solid brass arm
- 3-Year warranty

Part #	Mfg #	Description	Price
876638	PRO15	12" Ballcock less Flapper	7.58
876639	PRO15C	12" Ballcock with PRO53 Flapper	9.24

### Flappers PRO53 Flappers

- Professional grade material
- Kink-free heavy duty metal chain
- Replaces most worn flapper or tank ball units



Part #	Mfg #	Description	Price
876640	PRO53	Heavy-Duty Flapper	3.53

### PRO54 Flappers

- Chlorine resistant material
- Kink-free heavy-duty metal chain
- Won't rot, great for harsh water situations



Part #	Mfg #	Description	Price
876642	PRO54	Chlorine Resistant Heavy-Duty Flapper	4.62

### PRO55 Flappers

- Adjustable volume for optimal flushes every time
- Chlorine resistant
- Heavy-duty metal chain with float
- Fits most flapper or tank ball units



Part #	Mfg #	Description	Price
876643	PRO55	Flapper w/Adjustable Float	5.43
876644	PRO55R	Flapper w/Adjustable Float - 3/Pk	13.85

### Seal-O-Matic® Toilet Flappers



Part #	Mfg #	Description	Price
18319	B-260B	Seal-O-Matic®	1.55
883525	B-260V	Seal-O-Matic®	2.47

### Sealmaster® Toilet Flappers



Part #	Mfg #	Description	Price
18320	B-264V	Sealmaster® Standard	2.53

### Korky® Toilet Flappers



2001BP



54BP

Part #	Mfg #	Description	Price
138152	2001BP	Red Korky® Plus	3.84
18315	54BP	Korky®	2.92
18316	57	Korky® OEM Fit for Crane Old Style Toilets	2.95



## Toilet Accessories

### Bull's Eye® Flappers

- Basic repair for average conditions
- Replaces old tank ball or worn flapper
- Easy to install
- Hinged to rigid frame

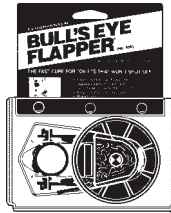

Part #	Mfg #	Description	Price
18291	500	Fits Most Tanks	3.79

### Flusher Fixer® Kit - 555C

- Includes new drain seat for repairing older, corroded tank drains
- Adjustable timing cup
- Chlorine resistant flapper for harsh water
- 5-Year warranty



Part #	Mfg #	Description	Price
18293	555C	Fits Most Tanks	8.91



### Speedy® Tank Cover

- High tension spring adjusts cover to fit round or beveled corner tanks, wall-hung or free-standing
- Top has recess styling



Part #	Mfg #	Description	Color	Price
17979	4211	High-Impact Plastic	White	16.87



### Tank Trip Levers



Part #	Mfg #	Description	Price
187630	T01-001	Chrome Fit-All, 9" Brass Arm	4.72

### Chrome-Plated Crown Tank Levers

- Flat brass arm with score line for easy trimming to American Standard size



Part #	Mfg #	Description	Price
18347	1318002	Domestic	10.42

## Fluidmaster

### Fluidmaster

#### Tank Levers

##### Sure-Fit® Tank Levers



- Trims/bends to fit most front, side and angle-mounted tanks
- No pre-measuring required - easy to install
- Self-tightening lock-nut won't loosen over time
- Durable, non-corroding plastic
- Fits most American Standard®, Eljer®, Kohler® Wellworth® brand toilets and more

Part #	Mfg #	Description	Price
881393	680	White	3.79
37765	681	Chrome	4.73

##### PRO64 Tank Lever



- Direct replacement tank lever
- European style chrome finished handle
- Self-Tightening lock nut (won't loosen over time)
- Fits most Eljer®, American Standard®, Kohler® Wellworth®, and Mansfield® toilets

Part #	Mfg #	Description	Price
876645	PRO64	Euro Style, Chrome	9.27

### No-Burst® Braided Stainless Steel Toilet Water Supply Connectors

- Nickel-plated brass water supply hex nut
- 250' Stainless steel wire per foot
- Extra long stainless ferrules
- 10-Year warranty



#### Toilet (Fem Comp x Fem Ballcock)

Part #	Mfg #	Length	Fittings	Price
18302	B1T06	6"	3/8" x 7/8"	3.19
18303	B1T09	9"	3/8" x 7/8"	3.19
18304	B1T12	12"	3/8" x 7/8"	3.38
18305	B1T16	16"	3/8" x 7/8"	3.89
18306	B1T20	20"	3/8" x 7/8"	4.21

Prices & specifications are subject to change.

You can check stock availability, pricing and place orders online at [www.MetPipe.com](http://www.MetPipe.com).



## Toilet Accessories

## Fluidmaster

Plumbing

### No-Burst® Braided Stainless Steel Toilet Water Supply Connectors (Continued)

#### Toilet (Fem Comp x Fem Ballcock)

Part #	Mfg #	Length	Fittings	Price
18308	B3T09	9"	1/2" x 7/8"	3.47

### No-Burst® Braided Stainless Steel Faucet Hot/Cold Water Supply Connectors

- Non-toxic polymer inner core surrounded by braided stainless steel
- Captured cone washers for perfect seal
- IAPMO Listed
- 10-Year warranty



#### Faucet (Fem Comp x FIP)

Part #	Mfg #	Length	Fittings	Price
18298	B1F09	9"	3/8" x 1/2"	3.31
18299	B1F12	12"	3/8" x 1/2"	3.55
18300	B1F16	16"	3/8" x 1/2"	3.89
18301	B1F20	20"	3/8" x 1/2"	4.21
56931	B1F30	30"	3/8" x 1/2"	5.02

#### Faucet (FIP Comp x FIP)

Part #	Mfg #	Length	Fittings	Price
45187	B3F12	12"	1/2" x 1/2"	3.93
52070	B3F20	20"	1/2" x 1/2"	4.43

#### Faucet (FIP Straight x FIP)

Part #	Mfg #	Length	Fittings	Price
137356	B4F12	12"	1/2" x 1/2"	4.02
213811	B4F20	20"	1/2" x 1/2"	4.43

#### Faucet (Fem Comp x Fem Comp)

Part #	Mfg #	Length	Fittings	Price
155556	B6F12	12"	3/8" x 3/8"	4.27
161137	B6F20	20"	3/8" x 3/8"	5.93

#### Faucet (Fem Comp x OD Copper Tubing Cplg)

Part #	Mfg #	Length	Fittings	Price
18311	B8F12	12"	3/8" x 3/8"	4.00

### No-Burst® Braided Stainless Steel Faucet Hot/Cold Water Supply Connectors (Continued)

#### Faucet (Fem Comp x OD Copper Tubing Cplg)

Part #	Mfg #	Length	Fittings	Price
18312	B8F20	20"	3/8" x 3/8"	5.05

### No-Burst® Braided Stainless Steel Appliance Water Supply Connectors

- Non-toxic polymer inner core surrounded by braided stainless steel
- Captured cone washers for perfect seal
- IAPMO Listed
- 10-Year warranty



#### Dishwasher Connector (Fem Comp x Fem Comp)

- Includes elbow

Part #	Mfg #	Length	Fittings	Price
18310	B6W48	48"	3/8" x 3/8"	9.83
804239	B6W72	72"	3/8" x 3/8"	13.57

### Washing Machine Water Supply (Hose Fitting x Hose Fitting)

- SS Flex WashMachine Supply Line
- 3/4"Hose x3/4"Hose x48"
- No Burst® Braided Stainless Steel
- 10 Year Warranty



Part #	Mfg #	Length	Fittings	Price
18313	B9WM72	72"	3/4" x 3/4"	14.02



### Wax Toilet Bowl Gaskets & Kits

- Conforms to TT-P-1536A Federal Specifications
- Fits 3" and 4" lines
- For floor closet bowls only

#### No-Seep No. 1 Wax Gasket with Polyethylene Flange



Part #	Mfg #	Description	Price
224696	001005	#1 Standard Wax	2.14





## Toilet Accessories

### No-Seep No. 3 Urethane Wax Gasket

- Fits 3" and 4" lines
- For floor & most wall bowls
- 10-Year guarantee



Part #	Mfg #	Description	Price
856186	004305-24	#3 Urethane	2.80

### Bol-Wax No. 5 Specialty Urethane Wax Gaskets

- Fits 3" and 4" lines
- For wall or floor bowls
- 10-Year guarantee



Part #	Mfg #	Description	Price
39597	011005	#5 Extra Thick Gasket	4.76

### Bol-Wax No. 6 Specialty Urethane Wax Gaskets

- Fits 2" outlet
- For urinals
- 10-Year guarantee



Part #	Mfg #	Description	Price
45630	011305	#6 Urinal Gasket	5.47

### Sponge Rubber Closet Gasket for Wall Hung Closet Bowls

- Dua-Cell no-wax
- Fits 3" and 4" waste lines
- Fits Zurn system



Part #	Mfg #	Description	Price
891400	071070	5-3/8"OD x 3-1/4"ID x 3/4" Thick	21.00



### Bowl Setting Bolts

#### Johni-Bolt®

- Original, patented, solid brass closet bolt with time saving snap-off slot and captive washer
- 2-1/4" Long
- Includes:
  - (2) Bolts
  - (2) Washers
  - (2) Brass cap nuts



Part #	Mfg #	Size	Price
12385	90124	5/16"	4.78

#### Johni Quick Bolt®

- Push-down and twist to tighten
- Includes a pair of each:
  - Solid brass bolts
  - Cap nuts
  - Stainless steel washers
  - Heavy-duty plastic washers



Part #	Mfg #	Size	Price
236496	90904	1/4" x 2-1/4"	2.91

### SetFast™ Self-Adjusting Closet Bolt

- No cutting
- Solid brass
- 9/16 Nut
- The true innovation behind this extraordinary fastener is in how it works! At first, the Hex Nut threads freely onto the bolt stud. After a number of turns the
- Hex Nut engages the Thread locker creating interference. Now when the Hex Nut turns so does the Bolt Stud. With each turn the Bolt Stud becomes shorter as it threads down into the Anchor Nut.



Part #	Mfg #	Size	Price
905205	42443	1/4" x 2-1/4"	3.33



## Toilet Accessories

Plumbing

### Bowl Setting Gaskets

#### Johni-Ring® Plus

- 100% No-leak special blend golden wax gasket for installing closet bowls
- Contains 40% more wax than standard bowl rings
- Makes positive, permanent, sanitary closet bowl seal
- Bacteria-free and won't dry or deteriorate



Part #	Mfg #	Description	Price
236984	90210	Wax Gasket (Plain)	1.69

#### Johni-Ring® Plus with Plastic Horn

- 100% No-leak special blend golden wax gasket for installing closet bowls
- Horn fits 3" and 4" waste lines
- Makes positive, permanent, sanitary closet bowl seal
- Bacteria-free and won't dry or deteriorate



Part #	Mfg #	Description	Price
236985	90220	Wax Gasket w/Horn	2.18

#### Johni-Ring® Plus for Back Outlet Toilets

- No-leak high quality golden wax gasket with sturdy felt core
- Fits most 4" hung and wall mounted toilets
- Makes permanent gas and water tight sanitary closet bowl seal
- Won't dry or deteriorate



Part #	Mfg #	Description	Price
871567	90270	Wax Gasket/Toilet	2.71



### Closet Flange Extensions

#### CF300 Closet Flange Extension Kits

- Stackable and self-sealing
- Includes:
  - (3) 1/4" Self-sealing extender
  - (2) 3-1/2" Closet bolts with washers and nuts
  - (1) 1-1/2 oz Tube of sealant (for use on old flange only)

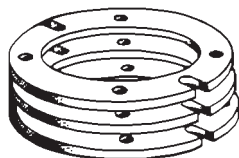

Part #	Mfg #	Description	Price
18523	CF300P	For Use with PVC	7.90

### 4" Closet Flange Replacement

- Allows up to 3" of adjustment to riser
- Compression joint
- Slides into 4" cast iron

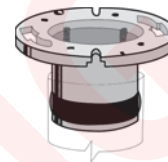

Part #	Mfg #	Description	Price
18524	GH950P	For Use with PVC	19.90

## PASCO

### Closet Rings

#### Quick Ring

- Replaces any and all closet rings
- Unique screw tabs attach to wood or concrete
- Plastisol coat provides corrosion protection
- Slotted for 1/4" or 5/16" closet bolt
- Old closet ring does not need to be present

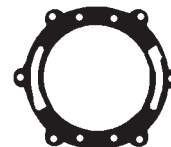

Part #	Mfg #	Description	Price
35788	21013	Quick Ring Closet Ring	7.45

### Spanner Flange - Repair



Part #	Mfg #	Description	Price
18522	1354002	Spanner Repair Flange	5.10

### Radiator Specialty Company

### Toilet Parts

#### Bowl Rings



Part #	Mfg #	Description	Pkg Qty	Price
12383	G-227	Rubber Bowl Ring	12	3.32

### Kant-Leak® Flanged Bowl Rings



Part #	Mfg #	Description	Price
12381	G-237-D	Standard Wax Ring with Flange	0.95

Prices & specifications are subject to change.



## Toilet Accessories

Radiator Specialty Company

### Triple Seal Tank Balls



B-251/B-252

Part #	Mfg #	Description	Pkg Qty	Price
18314	B-251B	2-5/8" Standard	100	1.36
18317	B-252	3" Standard	12	2.30

### TITE-SEAL® Tank Balls

- Designed to fit the curvature of all flush valves



Part #	Mfg #	Description	Pkg Qty	Price
18318	B-254-12	Standard	12	2.48

### Spud Washers

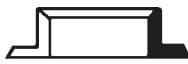

Flanged



Beveled



Reducing

Part #	Mfg #	Description	Pkg Qty	Price
18528	W-300	For 3/4" Urinal	12	1.40
18529	W-301	1-1/4" Flanged	12	0.93
18530	W-302	1-1/2" Flanged	12	1.24
18531	W-303	2" Flanged	12	1.07
18532	W-305	2" x 1-1/4"	12	1.42
18533	W-306	2" x 1-1/2"	12	1.42

### Flush Valve Shank Washers

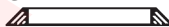

Part #	Mfg #	Description	Pkg Qty	Price
18553	W-856	Beveled - Heavy	12	1.30

### Closet Bolt Sets

- Includes:
  - (2) Solid brass bolts
  - (2) Solid brass hex nuts
  - (4) Solid brass washers
  - (4) Cloth-inserted washers
  - (2) Wing nuts



Part #	Mfg #	Description	Price
946173	1338000	Close-Coupled Tank-to-Bowl	5.37

### Closet Tank Bolt Gasket



Part #	Mfg #	Description	Pkg Qty	Price
234288	G-206	Closet TB Gaskets	100	14.00

### Close Couple Gaskets

#### Tank-to-Bowl



Part #	Mfg #	Description	Pkg Qty	Price
18323	G601	Standard Size	12	1.24
18322	G603	For Eljer	12	2.16
18324	G604	For Gerber & Crane	12	1.65
18325	G605	For Am Std & Crane	12	1.37



### PVC DWV Closet Flanges With Stainless Steel Ring (Hub)



- Fits into 4" and over 3" pipe

Part #	Mfg #	Size	Price
856705	PVC4325SS	4" x 3" x 2-1/2"	13.34
856709	PVC436SS	4" x 3" x 6"	21.80

### Street Flanges (Spigot)

- Fits into 3" hub

Part #	Mfg #	Description	Price
856707	3ST6 PVC	3" Street Flange, 6" Long with Stainless Ring	22.31



### Toilet Supplies Plastic Float Ball



Part #	Mfg #	Diameter	Price
18328	1332002	4"	1.01

### Brass Combination Overflow Tube

- 10in Length



Part #	Mfg #	Size	Gauge	Price
18350	1323004	1" x 1-1/8"	17	8.32
18349	1323012	1"	17	8.74

Prices & specifications are subject to change.

Our state of the art pipe shop offers cutting, threading, grooving and make-ons up to 36in!



## Toilet Accessories

Plumbing

### Closet/Urinal Spuds with Washer

- Includes washer



Part #	Mfg #	Description	Price
18327	1309016	1" x 3/4" Urinal Spud	5.58
18330	1309014	1-1/4" x 3/4" Urinal Spud	6.42
18331	1309012	1-1/4" x 1-1/4" Closet Spud	8.00
18332	1309010	1-1/2" x 1-1/4" Closet Spud	8.74
18333	1309008	1-1/2" x 1-1/2" Closet Spud	8.74
18336	1309006	2" x 1-1/4" Closet Spud	10.84
18335	1309004	2" x 1-1/2" Closet Spud	11.26
18334	1309002	2" x 2" Closet Spud	12.11

### Brass Ballcock Rods



Part #	Mfg #	Size	Price
18342	1321002	8"	2.63
18343	1321004	9"	3.16
18344	1321006	10"	2.63
18345	1321008	12"	3.16

### Refill Tubes



Part #	Mfg #	Description	Price
18340	1322002	Brass	6.21

### Brass Lift Wire



Part #	Mfg #	Description	Price
18338	1320004	5" Lower Lift Wire	0.95
18337	1319002	8" Upper Lift Wire	1.26

### Toilet Paper Roller



Part #	Mfg #	Description	Price
14909	1363002	Plastic	0.53

### Couplings

#### Chrome-Plated Brass Bathcock Coupling



Part #	Mfg #	Size	Price
12507	0625002	1/2"	15.79

### Brass Closet Screws

- Includes:

- (2) Screws
- (2) Nuts
- (2) Washers

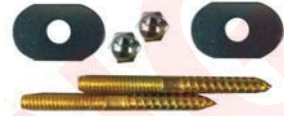

Part #	Mfg #	Size	Description	Price
152216	C02-300	1/4" x 2-1/2"	Oval	1.57
152219	C02-303	1/4" x 3-1/2"	Round	1.69

### Closet Spud Friction Ring

- Zinc-plated



Part #	Mfg #	Size	Price
18654	9360185	1" x 3/4"	0.51
18655	2710502	1-1/2" x 1-1/2"	0.53
18657	9362086	2" x 1-1/2"	0.93
18656	9360197	2" x 2"	0.85



### Closet Carrier Trim

- (4) Nuts and washers
- 5/8" nut - 11 threads



Part #	Mfg #	Description	Price
39119	Z1203	Trim Kit, 4-Pk	34.00

### "Neo-Seal" Closet Gasket Kit

- Includes:

- Neo-Seal gasket made from expanded closed-cell Dupont Neoprene
- Adhesive
- Instructions



- For carrier style closets

Part #	Mfg #	Description	Price
12379	Z1210-57	Kit	29.00
891400	Z1210-57-01	Gasket Only, Install using silicone caulk or ABS cement	21.00

Prices & specifications are subject to change.



## Pipe Plugs & Test Plugs

### Retrofit Trap Guard® Inserts

- Easy retrofit for problem drains
- Prevents sewer gas emission and raw sewage backflow
- Blocks insects and vermin
- Can be used above or below ground floor



Part #	Mfg #	Description	Price
855298	TG22IP	2" Fits Inside 2" CI Pipe	30.00
858504	TG33IP	3" Fits Inside 3" PVC or CI Pipe	34.00
809823	TG3H	3" Fits Inside 3" Hub	40.00
858502	TG33-ZURN	3" Fits Inside Zurn Z415 Tailpiece	38.00

### Closet Flange Spacers

#### Closet Bend Spacer

- Keeps poured concrete away from waste lines and closet bends
- Replaces Styrofoam, styrene coverings, coffee cans and duct tape

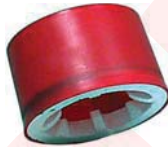

Part #	Mfg #	Size	Price
9930	S12-005	One Size Fits All	6.74

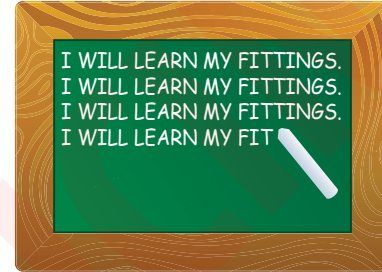

## Product Training

*Met Pipe offers training on every product we sell- from pumps to boilers. Let us organize a group training session for your team today!*



## Appliance Accessories



Plumbing

### Dormont Supr-Safe® Quick Disconnect Gas Appliance Connector Assemblies



- Annealed, 304 stainless steel (ASTM A240) tubing
- Approved for indoor and outdoor use
- Temperature rating with adapters: -40°F to 150°F
- Temperature rating with valves: -32°F to 125°F
- 100% Factory leak tested
- Code requires that a new gas appliance connector must be used for a new appliance, when moving an appliance to a new location, or as a result of damage.
- Avoid repeated bending, flexing, or extreme vibration. Do not use on generators due to excessive vibration.

Part #	Mfg #	Size	Price
139328	1650-BPQR-36	1/2" x 36"	183.75
139329	1675-BPQR-36	3/4" x 36"	240.35
139330	16100-BPQR-36	1" x 36"	303.93
139331	16125-BPQR-36	1-1/4" x 36"	467.64

### Brasscraft ProCoat Coated Stainless Steel Gas Connectors

- The ProCoat coating helps protect the stainless steel connector from corrosion due to prolonged exposure to harsh chemicals found in common household cleaning, plumbing repair and building products (ammonia, chlorine, solder flux and muriatic acid).
- Resistant to the harsh effects of UV rays and salt.
- Superior Corrosion Resistance
- Greater Strength & Flexibility
- Approved for Indoor and Outdoor Use
- 100% Leak Tested



Part #	Mfg #	Size	Price
15189	CSSC55-12	1/2" x 1/2" x 12"	11.59
15190	CSSC55-18	1/2" x 1/2" x 18"	14.37
15191	CSSC55-24	1/2" x 1/2" x 24"	17.00
15193	CSSC55-36	1/2" x 1/2" x 36"	20.29

### Brasscraft ProCoat Coated Stainless Steel Gas Connectors (Continued)

Part #	Mfg #	Size	Price
15194	CSSC55-48	1/2" x 1/2" x 48"	25.74
15185	CSSC22-18	3/4" x 3/4" x 18"	11.50
15186	CSSC22-24	3/4" x 3/4" x 24"	17.00
15188	CSSC22-36	3/4" x 3/4" x 36"	20.29
15195	CSSC22-48	3/4" x 3/4" x 48"	25.74



### Washing Machine Pans

- Provides lasting protection from washing machine overflow or hose failure
- Made from high impact plastic
- Will not rust or corrode
- Pans have formed hole to punch out for the furnished, 1" PVC plastic fitting



Part #	Mfg #	Description	Price
14916	34067	28" x 30" Plastic	26.31



### Washing Machine Valves

#### 2-M2 Series Washing Machine Water Shut-Off Valves

- Manually eliminates water pressure on supply hoses & prevents catastrophic water damage
- Controls hot & cold simultaneously
- Maximum pressure: 150 psi
- Maximum temperature: 180°F
- Bronze body, single lever on-off
- Dual copper adapters



#### Dual Elbow Adapters for 1/2" Sweat or 1/2" Compression

Part #	Mfg #	Model	Size	Price
16279	0006644	2M2	1/2"	52.72

#### Repair Kit For Series 2-M2 Valve

Part #	Mfg #	Model	Size	Price
16400	0862000	2M2RKT	1/2"	14.95



## Appliance Accessories



### Oatey Quadro® Washing Machine Outlet Boxes

- Patented, versatile design allows for right, left, or center drain and bottom or top mount valves
- "Lock and Load" valve mounting system for quick and easy positioning
- Single lever valve mounting hub locks into position in seconds
- Unique, easily installed and removed test cap that does not fall into drain
- Simplified and more efficient inventory
- A singular solution that benefits each level of the supply chain



Part #	Mfg #	Description	Price
871575	38535	2" Single lever ball valve, copper sweat	51.22



### Valves

#### Laundry-Mate® Washing Machine Valves



Part #	Mfg #	Description	Price
14476	W-400	Automatic, OFF & ON settings, 1/2" Sweat Union EII Connections	52.55
14477	W-500-B	Automatic, OFF & ON settings, Decorative Plastic Cover, 1/2" Sweat Union EII Connections	63.50
14478	W-600	Supply & Drain Fixture with 1/2" Sweat Union EII Connections & 1-1/2" Drain Connections	108.65
14479	W-602	Supply & Drain Fixture with 2" Drain Connections	111.90
36471	W-602-X	Laundry-Mate Supply & Drain Fixture, Service Stops, 2" Drain Connections	165.60



## Electronic Billing

Save time and get your invoices faster online, by email or fax!

Sign up today:

<http://ebilling.metpipe.com>



## Pipe Plugs & Test Plugs

Plumbing

### Mechanical Pipe Plugs

#### Iron Grip™ Mechanical By-Pass Plugs

- Neoprene rubber O-ring
- Cast-iron, by-pass design
- Large wing nut ensures easy installation
- Can be a permanent or temporary plug



Part #	Mfg #	Size	Max Air Pressure	Bypass Dia	Price
18482	268-028	2"	13 psi	3/8" MNPT	12.08
18483	268-038	3"	11 psi	1/2" MNPT	13.81
18484	268-048	4"	8.7 psi	1/2" MNPT	18.65
18485	A-05	5"	4.3 psi	1/2" MNPT	24.78
18486	268-068	6"	4.3 psi	1/2" MNPT	27.92
18487	268-088	8"	4.3 psi	1/2" MNPT	61.95
18488	268-108	10"	3.5 psi	1/2" MNPT	104.93
18489	268-128	12"	2.6 psi	1" MNPT	214.57
18490	A-15	15"	-	1" MNPT	394.34

### Mechanical Pipe Plugs

#### Kwik'N Sure® Plug

- Works in all types of pipe
- Ideal for plugging water line stub-outs
- Designed for high pressure applications
- Equipped with:
  - Natural rubber o-ring
  - Wing nut



Part #	Mfg #	Size	Price
38893	269-883	1-1/4"	5.22
17035	269-891	1-1/2"	5.73

### Gripper® Test Plugs

- Original Gripper® Plug
- Ideal for sewer testing and long-term applications
- Made with glass-reinforced ABS plastic
- End-of-pipe design seals only at the end of a pipe
- Inside-of-pipe design seals inside pipe as far as needed
- Equipped with:
  - Easy to install extra large zinc wing nut – won't rust
  - Natural rubber o-ring
  - Galvanized carriage bolt to prevent corrosion
- 17 PSI max back pressure



Part #	Mfg #	Size	Price
17029	270-210	1-1/2"	3.96
17030	270-229	2"	4.55
17031	270-237	3"	6.14

### Mechanical Pipe Plugs (Continued)

#### Gripper® Test Plugs

Part #	Mfg #	Size	Price
17032	270-245	4"	7.50
44994	271-551	5"	8.50
17033	270-261	6"	20.37
176261	270-270	8"	38.64

### Clean Seal Plugs

- Designed for stack testing of drain, waste, and vent plumbing systems, Clean-Seal® plugs thread into a standard test tee. The bladder is inflated and then water is introduced into the pipe. Upon test completion, deflate the bladder; water travels down the pipe, eliminating test water back splash.
- Works in both plastic and cast-iron test tees
- Natural rubber body provides a leak-free seal
- High-impact ABS threads for maximum durability
- Removable/replaceable tire inflation valve fitting
- 13 PSI max back pressure



Part #	Mfg #	Size	Price
34144	271-705	2"	34.68
34145	271-713	3"	37.70
34146	271-721	4"	43.62
881527	271-758	6"	109.15

### Pneumatic Pipe Plugs

#### Single-Size TEST-BALL®



Part #	Mfg #	Size	Price
17008	270-016	1-1/4" - 1-1/2"	29.47
17009	270-024	2"	31.44
17010	270-032	3"	33.99
17011	270-040	4"	39.44
17012	270-059	5"	74.82
17013	270-067	6"	98.48
17014	041-386	8"	155.93
17015	041-394	10"	252.95

Prices & specifications are subject to change.





## Pipe Plugs & Test Plugs

### Long TEST-BALL®

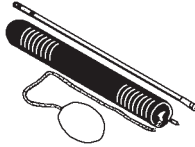

Part #	Mfg #	Size	Price
17017	271-020	2"	54.78
17018	271-039	3"	70.42
17019	271-047	4"	90.24
17021	271-063	6"	193.71

### Economy Test Plugs

- Fits cast iron and plastic pipe
- Molded rubber gasket
- Galvanized steel flanges



Part #	Mfg #	Pipe Size	Price
200581	T31-002	2"	3.05
200583	T31-003	3"	3.60
200584	T31-004	4"	4.35



### Plugs Lead Fit-All Plug



Part #	Mfg #	Size	Price
18465	2424002	2"	6.66
18466	2424004	2-1/2"	6.76
18467	2424006	3"	8.88
18468	2424008	3-1/2"	10.62
18469	2424010	4"	12.35
18470	2424012	4-1/2"	15.63
18471	2424014	5"	20.56
18472	2424016	5-1/2"	23.26
18473	2424018	6"	26.06



### No-Calk® Roof Flashing Aluminum Base No-Calk®

- Slides over pipe - for pitch to 40°
- Rustproof .032 stamped aluminum standard base
- Non-fading, sealing collar
- 18" x 18" Bases for code required areas
- Rated 180°F continuous heat
- Approved for Type B installations
- Not for hot-mopped or built-up roofs
- Soft aluminum base (18" x 18") allows for easy molding to tile roofing
- Do not use petroleum based products on collars



### Standard Base Flashing

Part #	Mfg #	Size	Price
9066	12933	2"	5.78
9067	12946	3"	6.32
9068	12959	4"	7.75

### Flex-Flash® Roof Flashing

- Slides over pipe - for pitch to 45°
- 100% Completely flexible/foldable
- Do not use petroleum based products on rubber bases or rubber collars
- Non-fading TPR base and collar
- No caulking needed
- Rated 180°F continuous heat
- Not for hot-mopped or built-up roofs

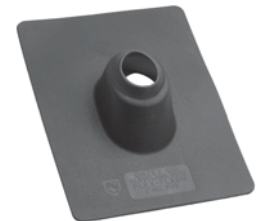

Part #	Mfg #	Size	Price
9071	14041	4"	10.20



### PROVENT Automatic Plumbing Vents

- BOCA and SBCC Approved
- Eliminates secondary stack for tubs, sinks, basins, showers and washing machines



Part #	Mfg #	Description	Price
18390	2430002	1-1/2" Female Waste Line Adapter	2.00



## Fire Equipment

Plumbing

### Fire Hose Fittings

#### Single Clapper Siamese - Straight

- UL Listed and FM approved
- Cast finish



Part #	Mfg #	Size	Price
177154	SCS4025F	4" FNPT x 2-1/2" FNST	173.51

#### Brass Hex Nipples (FNPT x MNST)



Part #	Mfg #	Size	Price
227030	FM1515F	1-1/2" FNPT x 1-1/2" MNST	24.38

#### (MNPT x MNST)



Part #	Mfg #	Size	Price
214402	DMH1515F	1-1/2" MNPT x 1-1/2" MNST	28.04
208525	DMH2525F	2-1/2" MNPT x 2-1/2" MNST	56.52

#### Brass Male Swivel Adapters with Pin Lugs

- Cast brass finish



Part #	Mfg #	Size	Price
193431	SM150F	1-1/2" FNST x 1-1/2" MNPT	26.99
219038	SM250F	2-1/2" FNST x 2-1/2" MNPT	58.23

#### Brass Plugs with Chain

- Cast brass finish
- Pin lug



Part #	Mfg #	Size	Price
875761	FP150F	1-1/2" MNST	34.59
166248	FP250F	2-1/2" MSNT	45.47

#### Brass Caps with Chain

- Cast brass finish
- Pin lug



Part #	Mfg #	Size	Price
220187	FC150F	1-1/2" FNST	17.46
872428	FC250F	2-1/2" FSNT	28.97

### Universal Hose Cap

- Not intended to be pressurized



Part #	Mfg #	Size	Price
166009	PFC250U	2-1/2"	16.46

### Breaker Cap

- Molded red thermoplastic
- Used on pin lug females



Part #	Mfg #	Size	Price
38971	PBC250	2-1/2"	7.07

### Rubber Fire Host Gaskets



Part #	Mfg #	Size	Price
885863	KRW20	1-1/2"	1.47
885862	KRW30	2-1/2"	3.23



### Hydrant Key

- Key for Z1300 wall hydrant

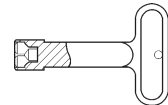

Part #	Mfg #	Description	Price
12380	59546-001	Key Only	20.00



### Fire Sprinklers & Parts

#### Sprinkler Head Cabinets

- Heavy gauge metal enclosure with hinged covers for on-site storage
- Painted red with knock-outs



Part #	Mfg #	Description	Price
871244	1119	(6) Head	41.00



## Fire Protection



### TY-B Series Sprinklers

- Special response - standard coverage, decorative 4 mm glass bulb sprinklers Intended to be installed either pendent or upright, and in either position,
- they produce a spherical water discharge pattern with approximately
- 50% of the discharge directed upwards and approximately 50% of the discharge directed downwards.
- 5MM Bulb
- 5.6 K-Factor



### TY-B 1/2" Upright Sprinklers

Part #	Mfg #	Temp Rating	Finish	Price
870663	57-570-1-155	155°F/68°C	Brass	9.86
870666	57-570-9-155	155°F/68°C	Chrome	11.66

### TY-B 1/2" Pendent Sprinklers

Part #	Mfg #	Temp Rating	Finish	Price
870662	57-571-1-155	155°F/68°C	Brass	9.86
870665	57-571-9-155	155°F/68°C	Chrome	11.66

### TY-B 1/2" Sidewall Sprinklers

Part #	Mfg #	Description	Price
870668	57-578-9-155	155°F/68°C Chrome	20.47

### Royal Flush II Concealed Pendent Sprinklers

- 5.6 K-Factor
- Quick and standard response
- Standard coverage
- Order cover separately



Part #	Mfg #	Part	Temp Rating	Price
870669	51-790-1-155	TY3551	155°F/68°C	28.07

### Cover Plate for Royal Flush II Sprinkler

Part #	Mfg #	Description	Price
859535	56-792-0-135	Cover Plate for Use with 155°F Sprinkler, Flat White	14.48

### Royal Flush II Parts



56-938-1-001

Part #	Mfg #	Description	Price
870681	56-938-1-001	G1 Sprinkler Guard, Red Painted	8.15

### Style 65 1-Piece Sprinkler Escutcheon



Part #	Mfg #	Size	Price
870672	1153	1/2"	1.31

### Tools

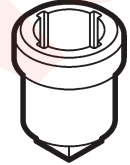

Part #	Mfg #	Description	Price
870670	56-000-1-075	Wrench for Royal Flush Sprinklers	77.00



### Grooved Fire Protection Fittings



VdS



501 - 45° Cast Elbows

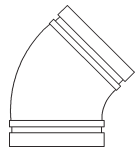

Part #	Mfg #	Size	Price
873776	501	2"	11.68
873774	501	2-1/2"	15.92
873777	501	3"	21.95
873778	501	4"	30.93
873779	501	6"	86.76
873821	501	8"	173.25

510 - 90° Cast Elbows

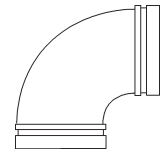

Part #	Mfg #	Size	Price
873768	510	2"	11.30
873773	510	2-1/2"	15.92
873770	510	3"	22.46
873771	510	4"	31.70
873772	510	6"	89.32
873822	510	8"	178.90

Prices & specifications are subject to change.

Our office hours are 7am to 4:30pm and counter hours 6am to 4:30pm Monday through Friday.



## Fire Protection

### 519 - Cast Tees

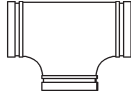

Part #	Mfg #	Size	Price
873783	519	2"	19.64
873784	519	2-1/2"	25.93
873782	519	3"	36.45
873781	519	4"	56.21
873780	519	6"	151.69
873819	519	8"	321.86

### 577 - Rigid Coupling

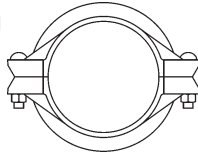

Part #	Mfg #	Size	Price
873766	577	2"	12.06
873767	577	2-1/2"	14.07
873765	577	3"	16.46
873764	577	4"	21.48
873763	577	6"	37.55

### 705 - Flexible Coupling



Part #	Mfg #	Size	Price
873758	705	2"	14.57
873762	705	2-1/2"	17.08
873757	705	3"	19.09
871624	705	4"	25.63
873760	705	6"	47.22
873823	705	8"	63.80



### Brass Hose Fittings

#### Brass Adapters (MHT x MIP)



Part #	Mfg #	Size	Price
16813	G20-003	3/4" MHT x 3/4" MIP (1/2" FIP Tap)	3.31
16812	G20-004	3/4" MHT x 1/2" MIP (1/2" Sweat)	3.51

#### Brass Adapters (MHT x MHT)



Part #	Mfg #	Size	Price
16814	G20-008	3/4" MHT x 3/4" MHT (1/2" FIP Tap)	3.52

#### Brass Adapters (MHT x FIP)



Part #	Mfg #	Size	Price
16809	G20-010	3/4" MHT x 1/2" FIP	2.85
16810	G20-011	3/4" MHT x 3/4" FIP	3.97

#### Brass Adapters (FHT x MIP)



Part #	Mfg #	Size	Price
16811	G20-016	3/4" FHT x 3/4" MIP (1/2" FIP Tap)	3.97

#### Brass Adapters (FHT x FIP)



Part #	Mfg #	Size	Price
16807	G20-020	3/4" FHT x 1/2" FIP	3.74
16808	G20-021	3/4" FHT x 3/4" FIP	4.56

#### Brass Swivel Adapter (Swivel FHT x FHT)



Part #	Mfg #	Size	Price
16806	G20-030	3/4" FHT x 3/4" FHT	4.14

#### Brass Swivel Adapter (Swivel FHT x FIP)



Part #	Mfg #	Size	Price
16804	G20-031	3/4" FHT x 1/2" FIP	3.71
16805	G20-032	3/4" FHT x 3/4" FIP	4.65

#### Brass Hose Wye (FHT x MHT)



Part #	Mfg #	Size	Price
16823	G20-050	3/4" FHT x 3/4" MHT	8.74

Plumbing



## Garden Hose, Fittings & Accessories

### Brass Garden Hose Cap (FHT)



Part #	Mfg #	Size	Price
40785	G20-055	3/4" FHT	2.23

### Brass Hose Barbs Hose Barb to Male Pipe



- Barb refers to hose ID

Part #	Mfg #	Size	Price
215564	G25-022	1/8" Barb x 1/8" MPT	1.26
16826	G25-042	1/4" Barb x 1/8" MPT	4.65
16828	G25-044	1/4" Barb x 1/4" MPT	1.04
16827	G25-062	3/8" Barb x 1/8" MPT	0.96
16829	G25-064	3/8" Barb x 1/4" MPT	1.07
55505	G25-068	3/8" Barb x 1/2" MPT	3.33
200735	G25-121	3/4" Barb x 3/4" MIP	5.69
192097	G25-169	1" Barb x 1" MIP	13.27

### Hose Barb to Female Pipe

Part #	Mfg #	Size	Price
16835	G26-044	1/4" Barb x 1/4" FPT	2.19
182819	G26-046	1/4" Barb x 3/8" FPT	1.74
16836	G26-064	3/8" Barb x 1/4" FPT	3.49
114411	G26-066	3/8" Barb x 3/8" FPT	6.73
182820	G26-068	3/8" Barb x 1/2" FPT	3.33
16837	G26-084	1/2" Barb x 1/4" FPT	2.03
182821	G26-086	1/2" Barb x 3/8" FPT	1.67
114413	G26-088	1/2" Barb x 1/2" FPT	9.15

### Garden Hose

- 300 psi Burst strength
- Solid brass couplings
- Green nylon construction
- Nylon reinforced



Part #	Mfg #	Description	Price
216873	G04-002	General Purpose 50' Hose	34.76
204440	SNCHW58050	Hot Water 50' Hose	62.81

### Hose Nozzle

- 4in Brass Hose Nozzle



Part #	Mfg #	Description	Price
16799	2608002	3/4" Hose Thread, Brass	9.77

### Pistol Grip Hose Nozzle

- Chrome plated economy pistol grip hose nozzle



Part #	Mfg #	Description	Price
16800	2609002	3/4" Hose Thread, Chrome-Plated	6.11

### Rubber Hose Washers

Part #	Mfg #	Description	Price
18558	2724002	Rubber Hose Washer	0.08

### Hose Stations

#### 102 Series Wall-Mounted Hose Stations

- Color coded control handles, check valves, hose outlet
- Stainless steel hose rack
- Heat-proof, stainless steel nozzle
- Double banded, cast bronze couplings
- Rubber hose
- 102-A: 1-1/2" x 50' hose, plastic adjustable nozzle
- 102-B: 3/4" x 50' hose, grip nozzle stainless steel
- 102-C: 3/4" x 50' hose, grip nozzle stainless steel
- Custom made per order - please call for more information.



Part #	Mfg #	Description	Price
Call	102-A	Hot/Cold Supplies - 3/4"	Call
Call	102-B	Single Supply - 3/4"	Call
Call	102-C	Single Supply - 1-1/2"	Call

### Safety Sign

- "CAUTION - Water is unsafe and is not to be used for drinking, washing, or cooking purposes"

Part #	Mfg #	Description	Price
133680	B120	7" x 10" Sign	Call



## Pumps

Little **GIANT**

### Laundry Tray Style Pumps

#### Little Giant Compact Drinosaur® Water Removal Systems

- Compact unit includes 3-1/2 gallon tank, only 10-1/2" high. Automatic submersible pump with mid-level activating switch and 8' power cord..
- Pre-assembled for easy installation
- Cylindrical polypropylene tank
- UL / CSA Listed
- IAPMO approved basins
- ~45 gpm at 5' Head



Little **GIANT**

Part #	Mfg #	Horsepower	Voltage	Width	Height	Weight	Cord Length	Price
40686	WRSC-6	1/3	115	14"	10.5"	24 Lbs	8'	311.39

#### Liberty 404 Compact/Low Profile Drain Pump

- Compact design for tight areas.
- Factory pre-assembled.
- Fully automatic operation.
- QuickTree® technology allows quick inspection and removal of float switch without disconnecting the plumbing.
- Integrally molded rubber gaskets for a superior gas-tight seal.
- Oil-filled, hermetically sealed motor with thermal-overload protection
- Corrosion-resistant poly olefin basin with molded-in connections.
- Maintenance-free, permanently lubricated sealed bearings.
- 3/8" Solids-Handling
- 1-1/2" FPT inlet, discharge, vent
- ~35 gpm at 5' Head



Liberty **Pumps**

Part #	Mfg #	Horsepower	Voltage	Width	Height	Weight	Cord Length	Price
15816	404	1/3	115	13-3/4"	11-1/8"	13 Lbs	10'	302.00

#### Liberty 405 Commercial-Grade Drain Pump

- Factory pre-assembled.
- Fully automatic operation.
- QuickTree® technology allows quick inspection and removal of float switch without disconnecting the plumbing.
- Oil-filled motor with thermal-overload protection.
- Corrosion-resistant polyolefin basin with integrally molded rubber gasket for a superior gas-tight seal.
- Maintenance-free, permanently lubricated sealed bearings.
- 10' power cord with ground plug
- 3/8" Solids-Handling
- 1/2 hp
- ~56 gpm at 5' Head



Part #	Mfg #	Horsepower	Voltage	Width	Height	Weight	Cord Length	Price
890207	405	1/2	115	13-3/4"	14-1/8"	16 Lbs	10'	436.00



## Pumps

Little **GIANT**

### Zoeller Model 105 Laundry Tray Pump

- No inlet filters or screens to clean
- Polypropylene basin and lid
- Internal discharge pipe to lid (trap supplied by others)
- Check valve (30-0181)
- Easy installation, no need to dig a sump
- Automatic, float operated mechanical switch
- Passes 1/2" spherical solids
- 1-1/2" NPT discharge
- Non-clogging vortex impeller
- Glass-filled, polypropylene base with built in strainer on M53 and M55.
- Temperature rated 130°F
- UL Listed pump
- ~43 gpm @ 5' Head



Plumbing

Part #	Mfg #	Horsepower	Voltage	Width	Height	Weight	Cord Length	Price
15807	105 (M53)	0.3	115	14-1/2"	12-1/2"	30 Lbs	9'	249.04

### Transfer Pumps

#### Little Giant Non-Submersible, Self-Priming Plated Brass Transfer Pump

- Self-priming for instant delivery or de-watering up to 6'
- Non-submersible plated brass pump body
- Rugged metallic handle for easy portability
- Dual threaded intake and discharge with both 3/4" male garden hose thread and 3/8" FNPT
- Includes pump, hose, strainer and suction adapter
- ~342 gph @ 5' Head



Little **GIANT**

Part #	Mfg #	Horsepower	Voltage	Width	Height	Weight	Cord Length	Price
912681	360-K	1/10	115	4"	3.38"	N/A	6'	153.84

#### Liberty 331 Portable Transfer Pump

- One-piece cast aluminum pump and motor housing with integral carry handle
- Durable epoxy powder coat finish
- Convenient On/Off switch
- 3/4" brass garden hose connectors
- Glass reinforced thermoplastic impeller
- Permanently lubricated ball bearings
- Large prime plug with internal funnel design for easy priming
- Easily replaced motor brushes
- Maximum discharge head of 105'
- Maximum suction lift of 15'
- ~900 gph at 5' Head



**Liberty Pumps**

Part #	Mfg #	Horsepower	Voltage	Width	Height	Weight	Cord Length	Price
927702	331	1/2	115	4-1/2"	7"	10-1/2 Lbs	20'	281.00

Prices & specifications are subject to change.

We offer a variety of GREEN products such as flush valves, faucets, showerheads & more!



## Pumps

Little **GIANT**

### Floor Sucker Style Pumps Zoeller 42 Floor Sucker Indoor/Outdoor Utility Pump

- Use fully or partially submerged
- Durable polypropylene housing
- High quality sealed motor
- Thermal overload protected motor
- Adaptable for use with standard garden hose (fitting included), 1" NPT pipe, or 1-1/4" slip fit (use discharge hose kit P/N 1010-0117)
- Screened bottom may be removed to allow easy cleaning
- Oil free
- Removes water from any flat surface down to 1/8"
- Lightweight and portable; will fit in a 7" opening
- Non automatic
- ~900 gpm at 5' Head



Part #	Mfg #	Description	Cord						Price
55293	42	1/6	115	6"	9-1/2"	7.3 Lbs	9		90.79

### Little Giant 5-MSP Permanently Lubricated Utility Pump

- 1/6 HP shaded pole motor with overload protection
- Designed for continuous duty
- Pumps down to 1/8"
- Garden hose adapter
- Removable inlet screen for easy cleaning
- Epoxy coated cast aluminum housing
- Viton shaft seal
- ~1100 gph at 5' Head



Little **GIANT**

Part #	Mfg #	Horsepower	Voltage	Width	Height	Weight	Cord Length	Price
15818	5-MSP-10	1/6	115	4.31"	7.75"	8.25 Lbs	10'	120.26
111390	5-MSP-18	1/6	115	4.31"	7.75"	8.25 Lbs	18'	125.91

### Liberty 260 Submersible Utility Pump

- Thermoplastic body resists impact, stress, and corrosion
- Self-cleaning trash-type impeller
- 1/6 hp air cooled PSC motor
- Shaft seal and lip seal
- Thermal overload protection
- Pumps down to 1/8"
- Completely submersible
- Removable bottom screen for easy cleaning
- 3/4" Garden Hose Discharge
- ~960 gpm at 5' Head



Liberty **Pumps**

Part #	Mfg #	Horsepower	Voltage	Width	Height	Weight	Cord Length	Price
184346	260	1/6	115	7"	9.5"	7.5 Lbs	8'	112.00

Plumbing





## Pumps

Little **GIANT**

### Sump Pumps - Effluent Zoeller Effluent Sump, Dewatering Pumps

- Float operated, submersible
- Corrosion resistant powder coated epoxy finish
- Watertight neoprene square ring between motor and pump housing
- Solid buoyant polypropylene float
- Oil-filled, hermetically sealed, automatic reset thermal overload protected motor
- Passes 1/2" spherical solids
- 1-1/2" NPT discharge
- Stainless steel guard and handle
- Lower and upper bearings, oil fed, cast iron
- Model 53:
  - Cast iron switch case, motor and pump housing
  - Engineered, glass filled, plastic impeller with metal insert
- Model 57:
  - All cast iron construction
  - Cast iron impeller
- Model 59:
  - All bronze construction
  - Stainless steel guard and handle
  - Lower and upper bearings, oil fed, bronze
  - Bronze impeller
- ~2580 gph at 5' Head



Plumbing

Part #	Mfg #	Horsepower	Voltage	Width	Height	Weight	Cord Length	Price
75347	M53	3/10	115	10-3/32"	10-1/16"	23 Lbs	9'	164.33
15797	M57	3/10	115	10-3/32"	10-1/16"	28.5 Lbs	9'	180.99
15798	M59	3/10	115	10-3/32"	10-1/16"	30 Lbs	9'	1015.29

### Liberty 250 Series Sump/Effluent Professional Pump

- Rugged 1/3 hp motor, oil filled with thermal overload protection.
- 1/2" solids handling.
- 1-1/2" discharge.
- Hermetically sealed motor and switch cavities, and permanently lubricated bearings.
- Liberty's UNI-BODY casting – a solid, one piece housing that eliminates the lower motor seal ring found on other pumps.
- Epoxy powder coat finish
- Vortex style impeller for superior solids-handling.
- Fasteners – all non-corrosive stainless steel.
- 416 stainless steel rotor shaft.
- 2-Year limited warranty
- ~2700 gph at 5' Head



**Liberty Pumps**

Part #	Mfg #	Horsepower	Voltage	Width	Height	Weight	Cord Length	Price
875655	257	1/3	115	9.6"	10.5"	20 Lbs	10'	191.00

Prices & specifications are subject to change.

Our state of the art pipe shop offers cutting, threading, grooving and make-ons up to 36in!



## Pumps

Little **GIANT**

### Zoeller 98 Cast Iron Sump Effluent Dewatering Pump

- Corrosion resistant powder coated epoxy finish
- Durable cast iron construction
- Cast iron switch case, motor, pump housing and base
- All casting's are cast iron class 25-30 25000# tensile strength
- Float operated submersible (NEMA 6) 2 pole mechanical switch
- Permanent split capacitor motor, oil filled and hermetically sealed, automatic reset thermal overload protection
- Passes 1/2" spherical solids
- 1-1/2" NPT discharge
- ~4320 gph at 5' Head



**ZOELLER**  
PUMP CO.

Part #	Mfg #	Horsepower	Voltage	Width	Height	Weight	Cord Length	Price
15804	M98	1/2	115	10-1/8"	12"	39 Lbs	15'	249.04

### Zoeller 137 Series Cast Iron Sump Effluent Dewatering Pump

- Casting's - Model 137, all cast iron ASTM class 25, 2500# tensile strength.
- Corrosion resistant powder coated epoxy finish
- Durable cast iron construction - switch case motor and pump housing, base and impeller
- Float operated 2 pole mechanical switch
- Oil filled and hermetically sealed, automatic reset thermal overload protected (1 Ph) motor
- Passes 5/8" spherical solids
- 1-1/2" NPT discharge
- ~5580 gph @ 5' Head



**ZOELLER**  
PUMP CO.

Part #	Mfg #	Horsepower	Voltage	Width	Height	Weight	Cord Length	Price
15805	M137	1/2	115	12-1/4"	12-3/4"	47 Lbs	10'	373.97

### Zoeller 161 Cast Iron Sump Effluent Dewatering Pump

- Durable cast iron constructed switch case, base, motor and pump housing
- Cast iron class 25-30 (25,000X tensile strength)
- Impeller, bronze class 85-5-5-5
- Corrosion resistant powder coated epoxy finish
- Oil filled, hermetically, automatic reset thermal overload protected (single phase only) sealed motor
- Passes 3/4" spherical solids
- 1-1/2" NPT discharge
- Automatic units available with float operated, submersible (NEMA 6) 2 pole mechanical switch
- 3600 gph at 5' Head



**ZOELLER**  
PUMP CO.

Part #	Mfg #	Horsepower	Voltage	Width	Height	Weight	Cord Length	Price
15809	M163	1/2	115	12-3/4"	18-9/16"	80 Lbs	25'	857.87



## Pumps

Little **GIANT**

### Sump Pumps - Diaphragm Style

#### Little Giant Big John™ Submersible Sump Pump

- For residential and light commercial
- Cast iron motor housing is oil-filled for lifetime lubrication and excellent heat dissipation.
- Poly carbonate cover and polypropylene volute-base.
- 1/3 HP shaded pole motor with overload protection
- Designed for continuous duty
- Epoxy coated cast iron housing
- 1-1/2" discharge with an 18' maximum head
- Carbon/ceramic shaft seal
- Upper and lower sintered sleeve bearings
- UL / CSA listed
- 2760 gph at 5' Head



Little **GIANT**

Plumbing

Part #	Mfg #	Horsepower	Voltage	Width	Height	Weight	Cord Length	Price
15819	6-CIA	1/3	115	8-1/2"	6"	17.5 Lbs	8'	163.82

### Sump Pumps - Pedestal Style

#### Zoeller Dewatering and Sump Pedestal Pumps

- Metal enclosed, 115 V split phase motor, permanently lubricated, thermal overload protected
- Heavy duty thermoplastic or cast iron constructed pump housing and base
- Top intake strainer is part of pump housing, passes lint
- No strainer to deteriorate, replace or periodically clean
- High impact PVC (1-1/2" OD) column
- Non corrosive shaft
- Reliable positive displacement switch
- Chemically resistant polyethylene float
- Plated steel float rod
- Nylon guide
- Permanently lubricated upper sleeve bearing
- Durable lower bronze bushing
- Adjustable 12" cycle, factory set at 9"
- Model 81 - Plastic Construction
  - 1-1/4" FPT discharge
  - Thermoplastic, .3 HP
  - 3000 gph at 5' Head
- Model 82 - Cast Iron Construction
  - 1-1/2" FPT discharge
  - Cast Iron, 1/3 HP
  - 3120 gph at 5' Head



**ZOELLER**  
PUMP CO.

Part #	Mfg #	Horsepower	Voltage	Width	Height	Weight	Cord Length	Price
15801	M81	3/10	115	9.55"	31-1/4"	15 Lbs	7-1/2'	118.27
15802	M82	1/3	115	9.55"	31-3/4"	18 Lbs	7-1/2'	148.26

Prices & specifications are subject to change.

Metropolitan Pipe offers FREE DELIVERY in the Greater Boston area.



## Pumps

Little **GIANT**

Plumbing

### High Temperature Pumps

#### 3000 Series Cast Iron High-Temperature Submersible Dewatering Pump

- A high temperature submersible pump series with electrical components meeting the National Electrical Code requirements for 200° F service
- Comprehensive line of models, styles and modes
- Conduit length is 3 feet
- Power cord length is 15 feet for automatic models and supplied by others for non automatic models
- High temperature liquid-tight conduit used with high temperature cable
- High temperature motor windings
- High temperature Viton® gaskets
- High temperature thermal overload protected
- All control components in contact with water are high temperature rated
- All models have stainless steel screws, guards, handles and control arm and seal assemblies
- Float operated mechanical switch box which is mounted on the discharge pipe above the operating level (switch box is not intended to come in continuous contact with 200° F water)
- Mechanical seal has NI-Resist rotary face and Viton® elastomer
- Corrosion resistant powder coated epoxy finish
- 1-1/2" discharge
- ~3960 gph @ 5' Head



**ZOELLER**  
PUMP CO.

Part #	Mfg #	Horsepower	Voltage	Width	Height	Weight	Cord Length	Price
15812	3098-0001	1/2	115	N/A	N/A	52 Lbs	15'	659.65

#### Little Giant HT-10E Oil-Filled High Temperature Effluent Pump

- Specifically engineered to handle the tough, demanding tasks of wastewater and effluent waste efficiency and long-term dependability. For dewatering, effluent waste and wastewater where s. moved upward from a collection area to sewer or septic lines, or drainage areas.
- 1/2 HP split phase motor
- Designed for continuous duty
- Epoxy-coated cast iron housing
- Carbon/Ni-Resist & Viton shaft seal
- Upper and lower ball bearings
- CSA listed
- ~4800 gph @ 5' Head



Little **GIANT**

Part #	Mfg #	Horsepower	Voltage	Width	Height	Weight	Cord Length	Price
167111	511700	1/2	115	9.2"	9.6"	38 Lbs	10'	693.17



## Pumps

Little **GIANT**

Plumbing

### Sewage Pumps

#### Zoeller 267 "Waste Mate" Submersible Sewage Pump

- Float operated, submersible (NEMA 6) 2-pole mechanical switch
- Durable cast construction, ASTM Class 25 cast iron, switch case and pump housing, base
- Non-Clogging Vortex Impeller Design. Engineered plastic impeller with metal inserts
- Not effected by materials normally found in drainage and sewage pumps
- Passes 2" spherical solids
- Combination 2" NPT female 3" NPT male discharge
- Corrosion resistant powder coated epoxy finish
- Completely submersible- watertight and dust tight
- Automatic and non-automatic models available
- Automatic reset thermal overload protection (1 Phase only)
- ~7680 gph @ 5' Head



Part #	Mfg #	Horsepower	Voltage	Width	Height	Weight	Cord Length	Price
15811	M267	1/2	115	11-1/4"	14-9/32"	50 Lbs	10'	389.79

#### Zoeller 910 Series Sewage Package System

- Ideal for homes, farms, trailer courts, motels, restaurants and institutions where drain facilities are below existing sewer lines
- Maximum temperature rated at 130°F (54°C)
- Basins: Polyethylene structural foam, polyethylene or fiberglass
- Check valves: 2" cast iron and 2" PVC full flow design



Part #	Mfg #	Pumps	Volts	Basin & Cover	Unicheck	Weight	Price
199364	910-0005	M267	115	Poly-Foam-18X30-2V2D	2" C.I.	77	573.03

### Condensate Pumps

#### Little Giant 3-ABS Shallow Pan Condensate Removal Pump

- Designed for in-pan placement, the 3-ABS shallow pan pumps offer next generation technology for air conditioner condensate removal.
- Totally submersible pump with built-in, advanced non-mercury mechanical switch that automatically triggers operation when condensate in the pan or reservoir reaches a preset level.
- Automatic shutoff occurs when the condensate level drops.
- 1/12 HP oil filled motor
- Epoxy coated cast aluminum housing and motor cover
- Galvanized steel tank cover
- ABS tank, 1 gallon tank capacity
- Nylon volute, stainless steel shaft
- 1/2" MNPT discharge with brass check valve for 1/2" OD, rigid plastic or copper
- Viton shaft seal
- Advanced non-mercury mechanical switch
- Thermal overload protection
- 280 gph @ 5' Head



Little **GIANT**

Part #	Mfg #	Horsepower	Voltage	Width	Height	Weight	Cord Length	Price
904407	3-ABS	1/12	115	6"	6-1/2"	11-1/2 Lbs	9'	248.88

Prices & specifications are subject to change.

Metropolitan Pipe offers Vendor Managed Inventory - never run out of that part again!



## Pumps

Little **GIANT**

### Little Giant Automatic Condensate Removal Pump - VCMA Series

- 1/30 HP high performance motor
- ABS tank, motor cover, and volute
- 1/2 gallon tank capacity
- Stainless steel shaft
- Removable 3/8" barbed check valve
- 3 inlet drain holes
- Thermal overload protection
- Safety switch
- UL / CSA listed
- 70 gph @ 5' Head

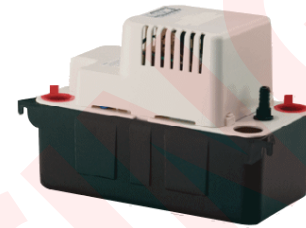

Little **GIANT**

Part #	Mfg #	Horsepower	Voltage	Width	Height	Weight	Cord Length	Price
188822	554425	1/30	115	5"	7"	5 Lbs	6'	60.45

### Little Giant Automatic Condensate Removal Pump - VC Series

- Low profile for limited space applications
- 1/30 HP motor
- ABS tank, motor cover, and volute
- 3/10 gallon tank capacity
- Stainless steel shaft
- Removable 3/8" barbed check valve
- Thermal overload protection
- Safety switch
- UL / CSA listed
- 70 gph @ 5' Head



Little **GIANT**

Part #	Mfg #	Horsepower	Voltage	Width	Height	Weight	Cord Length	Price
112570	VCC-20ULS	1/30	115	5"	5.12"	5.4 Lbs	6'	76.53



### "Full-Flow" Unichucks Cast Iron Slip x Slip Unions

- Checks backflow of water and sewer gas
- Neoprene gasket and flapper, weighted with heavy stainless steel metal backing plates and stainless steel rivet
- Reduces motor and pump noise
- Stops electrolysis
- Vertical or horizontal installation



Part #	Mfg #	Size	Price
15813	30-0151	2"	36.65

## Vendor Managed Inventory Program

Metropolitan Pipe can assist you in setting up your own **stockroom**- complete with barcodes for easy tracking.



Product ID: 454645

Kohler 4330-0 Kingston elongated wall-hung bowl with top spud



Aisle 7 - Shelf B



## Pumps

### PVC Slip x Slip Union

- Checks backflow of water and sewer gas
- Flapper bends over radius - no sharp 90° edges - lengthens life of flapper hinge
- PVC Plastic check body bolted together
- Vertical or horizontal installation



Part #	Mfg #	Size	Price
15814	30-0181	1-1/2" or 1-1/4"	10.83

### Sewage Basins



Part #	Mfg #	Size	Price
199355	31-1367	18" x 30"	49.15
199360	17-0419	18" PSF Lid for Basin	39.98

### Pump Parts

#### Universal Combo Hub

- Gasketed inlet for basin



Part #	Mfg #	Size	Price
199363	012094	4"	39.48

## Little GIANT

### Piggyback Diaphragm Switches

- 115V



Part #	Mfg #	Model	Description	Price
15827	599008	RS-5	10' Cord	46.46

### Sump Pump Drain Hose

- Includes:
  - 24' Corrugated plastic hose
  - 1-1/4" Plastic male adapter & stainless clamp



Part #	Mfg #	Description	Price
15815	0810002	Hose Kit	10.99



### Laundry Pumps

#### LTA Direct Mount Laundry Pump

- Pressure activated switch turns pump on when water enters tub
- Fits inside 24" base cabinet
- ABS High impact, corrosion resistant, plastic construction
- Mounts directly to sink tailpiece
- No traps required
- Integral junction box
- 8' Cord & plug
- 1/8 hp @ 1670 rpm Motor
- 1-Year warranty

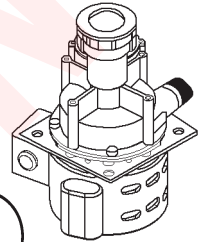

Part #	Mfg #	Model	Description	Price
53670	802210	LTA-1	115VAC, 2.2A	252.96

#### LTS High Capacity Laundry Reservoir Pump

- Heavy-duty pump used in commercial & industrial air-conditioning systems and large refrigeration unit
- Fits inside 24" base cabinets or under utility sinks
- Snap-action switch
- Suds-proof reservoir made of structural foam polypropylene
- 1-1/2" FNPT Inlet, 1" FNPT outlet
- 14" Maximum head, 180°F maximum temperature
- Sealed switch assembly
- Integral junction box
- 8' Cord & plug
- 1/3 hp @ 1750 rpm Motor
- 1-Year warranty



Part #	Mfg #	Model	Description	Price
15790	801285	LTS-1	115VAC, 5.6A	368.55

### Laundry Pump Switches

- Replacement switch and float assembly
- Use on Hartell pump models L-4, SC-1A and older LTS & LTP models



Part #	Mfg #	Model	Description	Price
15791	610053	L-111-A	Switch Replacement	97.40



## Water Heaters

### Ariston Pro Ti Point-of-Use Tankless Water Heaters

- Point-of-use hot water heaters can supply up to 2 sinks at a time and provide endless hot water and energy savings. These water heaters are easy to install and you will never have to worry about heat loss from long pipe runs. A point-of-use water heater is the perfect solution for home and office sinks... hot water without the wait.
- Ariston ProTi point-of-use electric mini tanks are designed with titanium for longer life. The "Titanium Plus Inside" glass lining protects the tank against leakage. These units can be installed independently or in-line with a larger hot water source eliminating long waits for hot water.
- Adjustable thermostat with thermal cut-out
- Dielectric isolation on inlet/outlet connections
- Units can be wall hung (bracket included) or floor mounted
- Durable poly-composite housing will not dent and resists corrosion
- Temperature/pressure relief valve included (plumb correctly for discharge)
- Simple 120V plug-in connection
- 8-year residential or commercial warranty
- Built with titanium for longer life
- Meets ASHR 90.1 standard
- Mounts on wall or floor
- Recovery at 90°F Rise - 6.8 gph
- T&P Relief valve installed on GL2.5Ti & GL4Ti, included on GL8Ti



### Eemax

#### "Single Point" Code Compliant Tankless Electric Hand Washing Heaters

- Cut energy costs - flow switch activates heater only on demand (no standby heat loss)
- 99% Energy Efficient - The power you use goes into the water, not up the chimney
- Compact Design - fits virtually below any sink
- Ease of installation - No T&P valve needed - Only bring one cold water line to lavatory
- Cold water feed only
- On demand hot water - never run out
- Complies with Handicap Requirements
- Compatible with Hands-Free, Sensor, and Metering Faucets
- Limited warranty: 1 year parts, 5 year leaks
- Voltage: 120V, Power: 3.5kW, Amperage: 30A
- Dimensions: 10.75" W x 5.25" H x 3" D
- Turn-on: 0.5 GPM
- Temperature rise at 0.5GPM = 48°F
- Connections: 3/8" compression fittings at top of unit
- Field Replaceable Element
- Weight: 4 lbs
- Proudly made in USA



Part #	Mfg #	Description	Price
798924	GL2.5Ti	2.5 gal	239.07
798929	GL4Ti	4.0 gal	250.82
798931	GL8Ti	8.0 gal, Can Supply (2) Sinks, Mounts Horizontally or Vertically	329.20

Part #	Mfg #	Volts	kW	Amps	Price
34038	SP3512	120	3.5	29	215.00





## Water Heaters



### Residential Gas Water Heaters

#### PowerVent™ Induced Draft Residential Gas Water Heater with The Guardian System™ 6-Year Limited Tank and Parts Warranty

- Silicon nitride igniter (HSI)
- Guardian System™ - air/fuel shut-off system offers double protection & no filter maintenance free
- Flammable vapor detection sensor
- PVC, ABS or CPVC Venting up to 100' with vertical or horizontal termination
- Integrated self-diagnostic system
- Low NOx design for low nitrous oxide emissions
- High altitude compliant
- EverKleen™ patented self-cleaning system on 40 - 60 gal models
- Patented magnesium anode rod design
- Standard 110V electrical connection
- Exceeds National Appliance Energy Conservation Act (NAECA) and ASHRAE requirements

T&P Valve Included



Heating

Part #	Mfg #	Type Gas	Gal Cap	Gas Input BTUH	Height to Top of Assembly	Jacket Dia	Vent Size	Energy Factor	Approx Ship Weight	Price
895993	PVP40FW	NG	40 gal	40,000	69-1/4"	19-3/4"	2" - 3"	0.64	140 lbs	970.43
895994	PVP50FW	NG	50 gal	42,000	68-1/4"	21-3/4"	2" - 3"	0.64	170 lbs	1019.75
895684	PVP75FW	NG	75 gal	75,000	69-1/2"	26-1/4"	3" - 4"	0.53	325 lbs	1438.31

#### Pacemaker® Residential Gas Water Heaters w/ The Guardian System™ 6-Year Limited Tank and Parts Warranty

- Guardian System™ - air/fuel shut-off system offers double protection & no filter maintenance free
- Low NOx design for low nitrous oxide emissions
- EverKleen™ patented self-cleaning system
- Easy to light - no matches required
- High altitude compliant
- Energy efficient
- Patented magnesium anode rod design
- Brass drain valve included
- Meets or exceeds National Appliance Energy Conservation Act (NAECA) requirements

T&P Valve Included



Part #	Mfg #	Type Gas	Gal Cap	Gas Input BTUH	Height to Top of Assembly	Jacket Dia	Vent Size	Energy Factor	Approx Ship Weight	Price
236047	P2-30S-30F	NG	30 gal	30,000	49-3/4"	19-3/4"	3"	0.61	98 lbs	483.88
876139	PH2-40SF	NG	40 gal	40,000	53-7/8"	20-1/8"	3"	0.59	130 lbs	435.90
859528	P2-50F1	NG	50 gal	38,000	61-1/2"	20-1/8"	3"	0.58	130 lbs	530.54
895681	PH2-75F	NG	75 gal	75,000	64"	26-1/4"	4"	0.53	320 lbs	933.10



## Water Heaters



**Pacemaker® Heavy-Duty Gas Water Heaters w/ The Guardian System™**  
**6-Year Limited Tank and Parts Warranty**

- Designed for high volume applications
  - High BTU input for fast recovery
  - Heat saving flue baffle design
  - Extra durable high temperature dip tube to meet the most stringent plumbing codes
  - Extra durable brass drain valve included
  - Meets or exceeds National Appliance Energy Conservation Act (NAECA) requirements
- T&P Valve Included**



Heating

Part #	Mfg #	Gas Type	Capacity	Gas Input BTUH	Height to Top of Assembly	Jacket Diameter	Vent Size	Energy Factor	Approx Ship Wt	Price
922119	P100F	NG	100 gal	75,000	68"	26-1/4"	4"	0.48	350 lbs	1699.58

### Residential Electric Water Heaters

**Pacemaker® Energy Miser® Electric Water Heaters**  
**6-Year Limited Tank and Parts Warranty**

- EverKleen™ patented self-cleaning system
  - Isolated tank design
  - High efficiency resistored heating elements
  - Electric junction box located above heating elements
  - Anode rod equalizes aggressive water action
  - Brass drain valve included
  - Automatic thermostat and over-temperature protector
  - 240V
  - Meets or exceeds National Appliance Energy Conservation Act (NAECA) requirements
- T&P Valve Included**



Part #	Mfg #	Capacity	Tank Height	Jacket Diameter	Energy Factor	Approx Ship Wt	Price
236059	PE2-30-2	30 gal	45-3/4"	19-3/4"	0.93	80 lbs	370.58
237161	PE2-40-2	40 gal	46-1/2"	19-3/4"	0.92	95 lbs	373.24
236061	PE2-52-2	50 gal	57"	21-3/4"	0.90	117 lbs	393.24
236062	PE2-66-2	65 gal	58-1/2"	21"	0.89	150 lbs	647.84
236063	PE2-80-2	80 gal	59"	23"	0.86	177 lbs	715.83
236064	PE2-120-2	120 gal	62-1/2"	28-1/4"	0.85	324 lbs	1416.98



## Water Heaters



**Point-of-Use Pacemaker® Energy Miser® Electric Water Heaters**  
**6-Year Limited Tank and Parts Warranty**

- Space-saving design for installation in limited spaces
- High efficiency heating elements
- Automatic thermostat and over-temperature protector
- Meets or exceeds National Appliance Energy Conservation Act (NAECA) requirements

**T&P Valve Included**

**6 Through 30 Gallon Point-of-Use Models**

- 3/4" NPT Outlet and inlet
- Anode rod
- Patented R-Foam® Insulation process
- Not available with 3-phase wiring
- Standard with 120V, 2000W single element



Part #	Mfg #	Capacity	Tank Height	Jacket Diameter	Approx Ship Wt	Price
16114	PEP-6-1	6 gal	15-1/4"	15-3/4"	36 lbs	258.61
16115	PEP-10-1	10 gal	23"	15-3/4"	46 lbs	325.26
16116	PEP-15-1	15 gal	24-1/4"	17-3/4"	54 lbs	365.25
16117	PEP-20-1	20 gal	25-1/4"	19-3/4"	69 lbs	405.24

Heating

**1•800•MetPipe**  
**www.MetPipe.com**



## Water Heaters

### Commercial Gas Water Heaters

#### Armor™ Condensing Commercial Water Heater

- Up to 98% Thermal Efficiency
- SMART SYSTEM Digital Operating Control Multi Color Graphic LCD Display
- Modulating Burner with 5:1 Turndown
- Direct-Spark Ignition
- Low NOx Operation
- Sealed Combustion
- Low Gas Pressure Operation
- Vertical & Horizontal Direct-Vent
- PVC, CPVC or SS Venting up to 100 Feet, PVC/CPVC Sidewall Vent Termination
- Stainless Steel Heat Exchanger
- All Welded Construction, Gasketless Design
- 160 psi Working Pressure
- ASME Construction (AW 286-800)
- All Bronze Circulating Pump
- Flow Switch
- ASME Temperature & Pressure Relief Valve (286-801)
- Temperature & Pressure Gauge (AW 501-801)
- Downstream Test Valves (AW 501-801)
- Adjustable Leveling Legs
- Adjustable High Limit w/ Manual Reset, Automatic Reset High Limit
- Zero Clearances to Combustible Material
- 5 Year Limited Warranty (See Warranty for Details) 1 Year Parts Warranty (See Warranty for Details)



Heating

Part #	Mfg #	BTU/Hr Input	GPH @ 100° Rise	Height	Width	Length	Vent Size	Weight	Price
944080	AWN151PM	150,000	174	33-1/4"	15-1/2"	18"	3"	165 lbs	6478.00
944081	AWN200PM	199,999	235	33-1/4"	15-1/2"	22-1/4"	3"	185 lbs	6799.00
938636	AWN286PM	285,000	339	42-1/2"	15-1/2"	19-3/4"	4"	235 lbs	9856.00
942396	AWN400PM	399,999	475	42-1/2"	15-1/2"	27"	4"	295 lbs	13813.00
942346	AWN501PM	500,000	594	42-1/2"	15-1/2"	31-1/2"	4"	335 lbs	16316.00
944051	AWN601PM	600,000	713	42-1/2"	15-1/2"	36-1/4"	4"	380 lbs	20525.00
944082	AWN701PM	700,000	832	42-1/2"	15-1/2"	40-1/4"	6"	461 lbs	23848.00
944083	AWN801PM	800,000	950	42-1/2"	15-1/2"	45-1/4"	6"	527 lbs	27747.00

Prices & specifications are subject to change.



## Water Heaters



### Shield™ Condensing Commercial Gas Water Heater

- 96% Thermal Efficiency
- Modulating Burner with 5:1 Turndown
- Operates at Temperatures up to 180°F for Sanitizing Applications
- Stainless Steel Heat Exchanger
- Glass-Lined Steel Tank
- 150 PSI Working Pressure
- ASME Tank Construction (SNA285–500)
- Zero Clearances to Combustible Material
- PVC, CPVC and Stainless Steel Venting up to 100 Equivalent Feet
- Direct-Vent Sealed Combustion
- Brass Drain Valve Rooftop and Sidewall Venting, Sidewall Vent Terminal
- Room Air Venting up to 100 Equiv. Feet
- Advanced Electronic Control, with 2-Line, 16-Character LCD Display
- Low-NOx Operation, Low Gas Pressure Operation
- Direct-Spark Ignition
- Certified for Installation on Combustible Floors
- ASME Temperature and Pressure Relief Valve
- 8-Foot Power Cord
- 3-Year Limited Warranty, 1-Year Parts Warranty



Heating

Part #	Mfg #	BTU/Hr Input	Capacity (Gallons)	GPH @ 100° Rise	First Hour GPH	Height	Diameter	Vent Size	Approx. Ship Wt	Price
944084	SNA285125*	150,000	93 gal	175	249	80"	28"	3"	620 lbs	17689.00
932315	SNA400125*	199,999	93 gal	233	307	80"	28"	3"	640 lbs	21692.00
920604	SNA500125*	285,000	125 gal	332	432	80"	34"	4"	835 lbs	25110.00
925633	SNR150100	399,999	125 gal	465	565	80"	34"	4"	855 lbs	11323.00
925680	SNR200100	500,000	125 gal	582	682	80"	34"	4"	895 lbs	11597.00

\* ASME Series

### Universal Gas Water Heaters - Commercial 3-Year Limited Tank Warranty

- Spark-to-pilot ignition system
- 80% Thermal efficiency
- Small jacket diameters
- Short floor-to-vent heights
- System Sentinel™ LED diagnostic system
- 180° Maximum operating temperature
- Patented multi-flue design
- Low profile automatic flue damper
- Stainless steel burners
- Full port, full flow brass drain valve

T&P Valve Included



Part #	Mfg #	Gas Type	Capacity	Input BTUH	Height To Top of Flue	Diameter	Flue	Approx Ship Wt	Price
118281	G50-98	NG	50 gal	98,000	62-3/4"	22-1/2"	5"	270 lbs	4051.00

Prices & specifications are subject to change.

We offer a variety of GREEN products such as flush valves, faucets, showerheads & more!



# Water Heaters

## Commercial Gas Water Heaters (Continued)

### Universal Gas Water Heaters - Commercial

Part #	Mfg #	Gas Type	Capacity	Input BTUH	Height To Top of Flue	Diameter	Flue	Approx Ship Wt	Price
118278	G75-75	NG	75 gal	75,100	64"	26-1/4"	4"	320 lbs	2012.00
171310	G75-125	NG	75 gal	125,000	65-1/2"	26-1/4"	5"	480 lbs	4198.00
118293	G76-200	NG	76 gal	199,900	68-13/16"	26-1/4"	6"	540 lbs	5010.00
118286	G82-156	NG	82 gal	156,000	68-13/16"	26-1/4"	6"	490 lbs	4829.00
118294	G91-200	NG	91 gal	199,900	76-5/16"	26-1/4"	6"	600 lbs	5120.00
118296	G72-250A	ASME NG	72 gal	250,000	71-1/16"	26-1/4"	8"	590 lbs	7273.00
818765	G85-300A	ASME NG	85 gal	300,000	78-7/16"	26-1/4"	8"	640 lbs	7879.00
159292	G65-360A	ASME NG	65 gal	360,000	70-11/16"	26-1/4"	8"	640 lbs	8763.00

## Commercial Electric Water Heaters

### Point-of-use Commercial Electric Water Heaters 3-Year Limited Warranty (Tank) 1-Year Limited Warranty (Parts)

- Porcelain enamel lined tank
- Heavy duty anode rod
- Rigid polyurethane foam insulation provides superior insulating qualities resulting in reduced operating costs.
- Baked enamel steel jacket
- Patented resistor heating element
- A surface mounted thermostat automatically cycles on and off to maintain the water temperature at a desired preset level.
- Manual reset high limit control
- Factory installed AGA/ASME rated Temperature and Pressure relief valve



		Capacity	Wattage	Volts	Cycles	Phases	Height	Diameter	Weight	
167496	EGSP-6	6 gal	3KW	208	60	1	15-1/8"	15-3/4"	41 lbs	508.00
180962	EGSP-6	6 gal	2KW	277	60	1	15-1/8"	15-3/4"	41 lbs	508.00
860170	EGSP-6	6 gal	3KW	277	60	1	15-1/8"	15-3/4"	41 lbs	508.00
890452	EGSP-6	6 gal	3KW	480	60	1	15-1/8"	15-3/4"	41 lbs	508.00
218843	EGSP-6	6 gal	6KW	277	60	1	15-1/8"	15-3/4"	41 lbs	508.00
856212	EGSP-10	10 gal	3KW	208	60	1	22-7/8"	15-3/4"	53 lbs	542.00
908894	EGSP-10	10 gal	3KW	277	60	1	22-7/8"	15-3/4"	53 lbs	542.00
146498	EGSP-10	10 gal	3KW	480	60	1	22-7/8"	15-3/4"	53 lbs	542.00
856503	EGSP-10	10 gal	4.5KW	208	60	1	22-7/8"	15-3/4"	53 lbs	542.00
861441	EGSP-10	10 gal	6KW	208	60	1	22-7/8"	15-3/4"	53 lbs	542.00
206523	EGSP-10	10 gal	6KW	277	60	1	22-7/8"	15-3/4"	53 lbs	542.00
163110	EGSP-15	15 gal	3KW	208	60	1	24-1/4"	17-3/4"	65 lbs	575.00
139614	EGSP-15	15 gal	3KW	277	60	1	24-1/4"	17-3/4"	65 lbs	575.00
218836	EGSP-20	20 gal	3KW	208	60	1	25-1/8"	19-3/4"	76 lbs	616.00
139432	EGSP-20	20 gal	3KW	277	60	1	25-1/8"	19-3/4"	76 lbs	616.00
904602	EGSP-20	20 gal	4.5KW	208	60	1	25-1/8"	19-3/4"	76 lbs	616.00
136109	EGSP-20	20 gal	6KW	480	60	1	25-1/8"	19-3/4"	76 lbs	616.00
176211	EGSP-30	30 gal	3KW	208	60	1	30in	21-3/4"	115 lbs	1301.00

Prices & specifications are subject to change.



## Water Heaters



### Light Duty Commercial Electric Water Heaters 3-Year Limited Warranty (Tank) 1-Year Limited Warranty (Parts)

- Porcelain enamel lined tank
- Heavy duty anode rod
- 2-1/2" of rigid polyurethane foam insulation provides superior insulating qualities resulting in reduced operating costs
- Baked enamel steel jacket
- Patented resistor heating elements
- Surface mounted thermostat
- Manual reset high limit control
- Durable brass drain valve
- Factory installed AGA/ASME rated Temperature and Pressure relief valve



		Capacity	Wattage	Volts	Cycles	Phases	Height	Diameter	Weight	
215400	ELDS-30	30 gal	3KW	208	60	3	29-1/2"	22-1/4"	105 lbs	1755.77
914773	ELDS-30	30 gal	4.5KW	480	60	3	29-1/2"	22-1/4"	105 lbs	1385.00
146303	ELDS-30	30 gal	6KW	480	60	3	29-1/2"	22-1/4"	105 lbs	1385.00
883779	ELDS-40	38 gal	4.5KW	480	60	3	31-1/2"	23"	135 lbs	1500.00
198027	ELD-120	119.9 gal	3KW	480	60	3	62-1/2"	28-1/4"	330 lbs	3628.85
874738	ELD-120	119.9 gal	5KW	208	60	3	62-1/2"	28-1/4"	330 lbs	3069.23

### Heavy-Duty Commercial Electric Hot Water Heaters 3-Year Limited Warranty (Tank) 1-Year Limited Warranty (Parts)

- System Sentinel™ L.E.D. diagnostic system
- Surface mounted and immersion thermostat models available
- Lifeguard stainless steel elements
- Manual reset high limit control
- Magnetic contacts and integral fusing
- Hot outlet and cold inlet are 1-1/2" NPT dielectric nipples which prevent excessive turbulence of heated water and results in optimum tank draw.
- 3" Rigid foam insulation.
- Heavy duty anode rods
- Full port, full blow, brass drain valve
- Factory Installed AGA/ASME rated Temperature and Pressure relief valve



		Capacity	Wattage	Volts	Cycles	Phases	Height	Diameter	Weight	
141139	ES-50-9-G	50 gal	9KW	480	60	3	43-5/8"	26-1/4"	270 lbs	2457.00
153461	ES-50-18-G	50 gal	18KW	480	60	3	43-5/8"	26-1/4"	270 lbs	2558.00
862958	ES-120-15-G	120 gal	15KW	480	60	3	67-5/8"	30-1/4"	430 lbs	3644.00
206098	ES-120-24-G	120 gal	24KW	480	60	3	67-5/8"	30-1/4"	430 lbs	5688.46
214536	ES-120-54-G	120 gal	54KW	480	60	3	67-5/8"	30-1/4"	430 lbs	6223.00

Prices & specifications are subject to change.

Our state of the art pipe shop offers cutting, threading, grooving and make-ons up to 36in!



# Water Heaters



## Commercial Storage Tanks

### Lochinvar Round Jacketed ASME Storage Tanks

- Energy Saving Performance
- ASME Construction
- Standard Durable Fused Glass Lining
- Horizontal & Vertical Configuration
- Lock-Temp Baffle
- 80 - 1000 Gallon Capacities
- 80% Draw Factor
- Five-Year Limited Warranty (See warranty for details)
- Lock-Temp Baffle
- Magnesium Anode



Part #	Mfg #	Capacity	Jacket Height	Diameter	Top Outlet/Front Side Connections	Max Working Pressure	Approx Ship Wt	Price
115716	RJA-120	119 gal	62-1/2"	28"	2" NPT	150 psi	365 lbs	4219.00
241710	RJA-175	175 gal	67-1/4"	32"	2-1/2" NPT	150 psi	578 lbs	5537.00

## Storage Tanks - Commercial

### 5-Year Limited Warranty Against Tank Leaks

- Meets or exceeds thermal efficiency & standby loss requirements of current ASHRAE standard
  - Installed individually, or in parallel manifold
  - Steel tank with two coats of high temperature porcelain enamel
  - (2) Magnesium anode rods
  - 2" Rigid polyurethane foam insulation
- Order T&P Valve Separately



Part #	Mfg #	Capacity	Jacket Height	Diameter	Top Outlet/Front Side Connections	Max Working Pressure	Approx Ship Wt	Price
118315	ST80	80 gal	58-1/2"	24-1/2"	2" NPT	150 psi	220 lbs	1294.00
118316	ST120	115 gal	59-1/4"	28-1/4"	2" NPT	150 psi	300 lbs	1362.00
118317	ST120A*	115 gal	59-1/4"	28-1/4"	2" NPT	160 psi	300 lbs	2713.00

\* ASME Construction

Heating





# Water Heaters



## Commercial Water Heaters

### ELECTRIC

Model	Cap. Gal.	Wattage	100° F Rise GPH	Ship Weight (LBS)
<b>Immersion Thermostat Models – 208/240V</b>				
E50-6-G	50	6 KW	25	270
E50-9-G	50	9 KW	37	270
E50-12-G	50	12 KW	49	270
E50-15-G	50	15 KW	61	270
E50-18-G	50	18 KW	74	270
E50-24-G	50	24 KW	98	270
E50-27-G	50	27 KW	111	270
E50-30-G	50	30 KW	123	270
E50-36-G	50	36 KW	147	270
E50-45-G	50	45 KW	184	270
E50-54-G	50	54 KW	221	270
E85-6-G	85	6 KW	25	350
E85-9-G	85	9 KW	37	350
E85-12-G	85	12 KW	49	350
E85-15-G	85	15 KW	61	350
E85-18-G	85	18 KW	74	350
E85-24-G	85	24 KW	98	350
E85-27-G	85	27 KW	111	350
E85-30-G	85	30 KW	123	350
E85-36-G	85	36 KW	147	350
E85-45-G	85	45 KW	184	350
E85-54-G	85	54 KW	221	350
E54A-81-GS <sup>1</sup>	85	81 KW	335	350
E120-6-G	120	6 KW	25	430
E120-9-G	120	9 KW	37	430
E120-12-G	120	12 KW	49	430
E120-15-G	120	15 KW	61	430
E120-18-G	120	18 KW	74	430
E120-24-G	120	24 KW	98	430
E120-27-G	120	27 KW	111	430
E120-30-G	120	30 KW	123	430
E120-36-G	120	36 KW	147	430
E120-45-G	120	45 KW	184	430
E120-54-G	120	54 KW	221	430
E120A-81GS <sup>1</sup>	120	81 KW	335	430

<sup>1</sup> 81 kW models available in 480V only.

Model	Cap. Gal.	Wattage	100° F Rise GPH	Ship Weight (LBS)
<b>Surface Mount Models – 208/240V</b>				
ES50-6-G	50	6	25	270
ES50-9-G	50	9	37	270
ES50-12-G	50	12	49	270
ES50-15-G	50	15	61	270
ES50-18-G	50	18	74	270
ES50-24-G	50	24	98	270
ES50-27-G	50	27	111	270
ES50-30-G	50	30	123	270
ES50-36-G	50	36	147	270
ES50-45-G	50	45	184	270
ES50-54-G	50	54	221	270
ES85-6-G	85	6	25	350
ES85-9-G	85	9	37	350
ES85-12-G	85	12	49	350
ES85-15-G	85	15	61	350
ES85-18-G	85	18	74	350
ES85-24-G	85	24	98	350
ES85-27-G	85	27	111	350
ES85-30-G	85	30	123	350
ES85-36-G	85	36	147	350
ES85-45-G	85	45	184	350
ES85-54-G	85	54	221	350
ES120-6-G	120	6	25	430
ES120-9-G	120	9	37	430
ES120-12-G	120	12	49	430
ES120-15-G	120	15	61	430
ES120-18-G	120	18	74	430
ES120-24-G	120	24	98	430
ES120-27-G	120	27	111	430
ES120-30-G	120	30	123	430
ES120-36-G	120	36	147	430
ES120-45-G	120	45	184	430
ES120-54-G	120	54	221	430

Heating



## Water Heaters

### Commercial Water Heaters

#### GAS

Heating

Model	Cap. Gal.	Input BTU/HR	100 F Rise GAL/HR <sup>2</sup>	Vent Size (Inches)	Height to Draft Hood	Jacket Diameter	Ship Weight (LBS)
<b>Heavy Duty Storage Models (with Sentinel™ Diagnostic System)</b>							
G50-98	50	98,000	95	5	62-3/4	22-1/2	270
G75-125	75	125,000	121	5	65-1/2	26-1/4	480
G82-156	82	156,000	151	6	68-13/16	26-1/4	490
G76-180	76	180,000	175	6	68-13/16	26-1/4	540
G37-200	37	199,900	194	6	49	26-1/4	450
G76-200	76	199,900	194	6	68-13/16	26-1/4	540
G91-200	91	199,900	194	6	76-5/16	26-1/4	600
G100-200	100	199,900	194	6	73-1/16	30-1/4	780
G100-200A <sup>1</sup>	100	199,900	242	6	73-1/16	30-1/4	820
G72-250	72	250,000	242	6	71-1/16	26-1/4	590
G72-250A <sup>1</sup>	72	250,000	242	6	71-1/16	26-1/4	630
G100-250	100	250,000	242	8	73-1/4	30-1/4	795
G100-250A <sup>1</sup>	100	250,000	242	8	73-1/4	30-1/4	835
G100-270	100	270,000	262	8	73-7/8	30-1/4	805
G100-270A <sup>1</sup>	100	270,000	262	8	73-7/8	30-1/4	845
G72-300	72	300,000	291	8	71	26-1/4	590
G72-300A <sup>1</sup>	72	300,000	291	8	71	26-1/4	630
G85-300	85	300,000	291	8	78-7/16	26-1/4	640
G85-300A <sup>1</sup>	85	300,000	291	8	78-7/16	26-1/4	680
G100-310	100	310,000	301	7	75	30-1/4	770
G100-310A <sup>1</sup>	100	310,000	301	7	75	30-1/4	870
G65-360	65	360,000	349	8	70-11/16	26-1/4	640
G65-360A <sup>1</sup>	65	360,000	349	8	70-11/16	26-1/4	680
G65-400	65	399,900	388	8	70-11/16	26-1/4	640
G65-400A <sup>1</sup>	65	399,900	388	8	70-11/16	26-1/4	680
G85-400	85	399,900	388	10	78-13/16	26-1/4	640
G85-400A <sup>1</sup>	85	399,900	388	10	78-13/16	26-1/4	680
G100-400	100	399,900	388	8	76	30-1/4	770
G100-400A <sup>1</sup>	100	399,900	388	8	76	30-1/4	810

<sup>1</sup> ASME

<sup>2</sup> Tested at or above 80% thermal efficiency.



## Water Heaters



### Indirect Water Heaters

#### SuperStor Ultra Stainless Steel Indirect Water Heaters Limited Lifetime Warranty

- Low energy costs – when used in conjunction with an HTP high-efficiency boiler, operating costs decrease even further
- Appropriate for both residential and commercial applications – available in seven models (ranging from 20 to 119 gallons)
- Low standby losses – the tank loses only 1/2 degree Fahrenheit per hour, thanks to 2" of environmentally safe foam insulation
- Virtually maintenance free operation – the simple design of the heat exchanger eliminates the need for costly scheduled maintenance services
- Installation flexibility – can be linked to a boiler using either a zone valve or a circulated pump
- Quality construction – an extremely durable kupfer-nickel heat exchanger boasts excellent heat transfer properties and resists corrosion, while the robust 316L stainless steel tank eliminates the need for anode rods
- Aesthetically pleasing – the attractive and durable silver plastic jacket ensures a rustproof finish, even in moist environments
- Limited lifetime warranty – covered by the industry's strongest protection plan



Heating

Part #	Mfg #	Boiler Model	Circulator Rate	Tank Capacity	Boiler Side Capacity	Height to Top of Tank	Tank Diameter	Approx Ship Wt	Price
208785	SSU45LC	-	20 gpm	45 gal	3/4"	42"	23-1/4"	84 lbs	1090.85
210059	SSU60LC	-	22 gpm	60 gal	1"	52-1/2"	23-1/4"	106 lbs	1568.31
208948	SSU80-LC	-	24 gpm	80 gal	1-1/2"	72"	23-1/4"	141 lbs-	1839.15

### Accessories

#### Honeywell Aquastat Control for SuperStor

- Immersion type Aquastat with 100 F to 200 F

Part #	Mfg #	Description	Price
871158	L4080B-1352	Aquastat for SuperStor Indirect Heater	59.37



# Water Heaters

## Indirect Water Heaters

### Weil-McLain Aqua Plus Indirect Fired Water Heaters

- 316L Stainless Steel tank welded with "TIG and Plasma" technology coil tank
  - Higher tolerance against corrosion vs. carbon steel tanks
  - 100% air pressure/water testing of tank and coil
- High output over 1" diameter 304 stainless steel heat exchanger
  - Superior 1st hour rating and recovery
  - Large diameter heat exchanger allows for low pressure drop
- Temperature and pressure relief valve standard equipment
- Thermostat connections already installed for quick and easy wiring
- All connections including boiler supply and return, domestic water and domestic recirculation are on the side of the tank
- Magnesium Anode installed in all tanks
- Inspection port on ever tank located near the bottom of the tank
  - Hatch provides easy access for tank cleaning and inspection
- Exceptional "R Value" with 2" of dense foam insulation
  - CFC-free and environmentally safe
  - Low off cycle losses
- Adjustable feet for uneven floors



Part #	Mfg #	Model	Boiler Out MBH	200°F Boiler Water		Height	Diameter	Weight	Price
				115° DHW GPH	140°F DHW GPH				
947705	633-500-000	35	170	337	223	36-3/8"	21-7/8"	94 lbs	1113.70
947706	633-500-001	45	190	363	243	46-1/4"	21-7/8"	111 lbs	1120.25
947707	633-500-002	55	210	443	302	60"	21-7/8"	122 lbs	1514.66
947708	633-500-003	85	300	551	374	59-1/2"	26"	223 lbs	1863.26
947709	633-500-004	105	350	715	483	59-3/4"	30"	238 lbs	2666.82

Heating



### Squire™ Stainless Steel Indirect Water Heater

- The Squire Indirect Water Heater was designed to use the power and efficiency of a residential boiler to generate domestic hot water, consuming fuel more efficiently than a direct-fired water heater and significantly reducing operating costs.
- 100% Stainless Steel Construction
- 316L Passivated Stainless Steel Tank
- Fully Welded Construction
- Factory Supplied Tank Sensor, ASME T&P Relief Valve
- High Density CFC/HCFC Free Polyurethane Foam
- Tank Sensor Included for use with KNIGHT Heating Boiler



### Double Wall, Stainless Steel Indirect Water Heater

Part #	Mfg #	Capacity (Gallons)	1st Hour Delivery	Continuous Delivery	Height	Diameter	Approx Ship Wt	Price
944119	SDT065	65 gal	205 gal	175 gal	60"	24"	158 lbs	2588.00
944121	SDT080	79 gal	207 gal	175 gal	69-1/2"	24"	188 lbs	3035.00
944123	SDT119	119 gal	301 gal	250 gal	68-1/4"	28"	224 lbs	4620.00



## Water Heaters



### Single Wall, Stainless Steel Indirect Water Heater

Part #	Mfg #	Capacity (Gallons)	1st Hour Delivery	Continuous Delivery	Height	Diameter	Approx Ship Wt	Price
943774	SIT030	27 gal	183 gal	160 gal	39-1/2"	20"	79 lbs	1271.00
943287	SIT040	40 gal	208 gal	181 gal	55-1/2"	20"	105 lbs	1416.00
931794	SIT050	51.6 gal	255 gal	209 gal	47"	24"	131 lbs	1706.00
935772	SIT065	67 gal	327 gal	263 gal	60"	24"	147 lbs	2129.00
944117	SIT080	81.5 gal	347 gal	266 gal	69-1/2"	24"	177 lbs	2356.00
944118	SIT119	113.4 gal	459 gal	349 gal	68-1/4"	28"	213 lbs	3596.00

### Instantaneous Indirect Water Heaters

#### Turbomax Instantaneous Indirect Water Heater

- TURBOMAX heats water instantaneously, only when needed and keeps energy consumption to a minimum.
- Heat transfer efficiency reaching 99%
- Reduces and scrubs the accumulation of scale deposits that diminish the efficiency of traditional water heaters.
- Adapts to all thermal energy sources (gas, oil, electricity, wood, solar and recuperated heat)
- Reduces heating costs by up to 30%.
- Resists corrosion and thermal stress.
- Covered by a 10-year warranty
  - Standby loss < 1/2°F per hour
  - Heat Transfer Efficiency = 99%
  - Output Temperature up to 200°F
  - Coil Test Pressure = 700 PSI
  - Tank Test Pressure = 300 PSI
  - Rated Pressure = 150 PSI



Heating

Part #	Mfg #	Tank Volume	Heat Transfer Area (Sq. Ft.)	Utility Connection	Boiler Connection	Height	Diameter	Weight (Lbs)	Price
897397	T23	26 Gal.	19.6ft <sup>2</sup>	1-1/4" Sweat M	1-1/4" MNPT	49"	18"	150	911.00
936096	T44	48 Gal.	26.2ft <sup>2</sup>	1-1/2" Sweat M	1-1/4" MNPT	55"	22"	210	1552.00
903268	T45	48 Gal.	32.7ft <sup>2</sup>	1-1/2" Sweat M	1-1/4" MNPT	55"	22"	235	1634.00
228593	T65	72 Gal.	32.7ft <sup>2</sup>	1-1/2" Sweat M	1-1/2" MNPT	67"	24"	250	2050.00
935341	T65A*	72 Gal.	32.7ft <sup>2</sup>	1-1/2" Sweat M	1-1/2" MNPT	67"	24"	250	3565.00
193702	T109	119 Gal.	58.9ft <sup>2</sup>	2" Sweat M	2" MNPT	74"	29"	555	3677.00
887669	T109A*	119 Gal.	58.9ft <sup>2</sup>	2" Sweat M	2" MNPT	74"	29"	555	4985.00

\* ASME Certified



## Water Heaters



### Condensing Tankless Water Heaters

- Navien Condensing 98% Tankless Water Heaters provide an unlimited amount of hot water at a steady temperature, whenever you need it, for as long as you need it.
- Because this product boasts the industry's highest efficiency rating (98%) means customers can cash in on low annual operating costs as well as receive the best pay back, compared with conventional tankless or tank-type water heaters. Navien also enjoys the highest gallons-per-minute (GPM) when comparing input BTU's.
- Navien utilizes condensing technology, which uses less gas, resulting in less CO2 emissions than conventional water heaters.
- Navien utilizes dual stainless-steel heat exchangers, providing 3.8 to 4.5 times longer life-expectancy and superior resistance to corrosion over the copper exchangers used in other brands. Navien heat exchangers operate with low-to-mid temperature water, minimizing possible damage caused by lime build-up, making the whole unit more efficient.
- The high efficiency of Navien heaters results in lower exhaust temperatures, allowing for the use of PVC venting.
- A Navien occupies approximately 90% less space than a tank-type water heater. In addition, a Navien mounts on your wall freeing up 100% of traditionally lost floor space.



#### Residential Condensing Tankless Water Heaters

Part #	Mfg #	Gas Type	Min Input BTUH	Max Input BTUH	Dimensions	Vent Size	Energy Factor	Approx Ship Wt	Price
931315	NR-180-NG	NG	15,000	150,000	17" x 28" x 14"	3"	0.96	67 lbs	1144.45
931243	NR-210-NG	NG	17,000	185,000	17" x 28" x 15"	4"	0.97	77 lbs	1308.34
935032	NR-240-NG	NG	17,000	199,000	17" x 28" x 15"	3"	0.97	77 lbs	1470.84

#### Commercial Condensing Tankless Water Heaters

Part #	Mfg #	Gas Type	Min Input BTUH	Max Input BTUH	Dimensions	Vent Size	Energy Factor	Approx Ship Wt	Price
919763	NP-240-NG	NG	17,000	199,000	17" x 28" x 15"	3"	0.95	77 lbs	1618.06

#### Models w/ Built-In Circulation Pump & Mini Buffer Tank

- Based on the standard Navien models, these also feature a Built-in Circulation Pump with Mini Buffer
- Delivers hot water to fixtures quickly resulting in water conservation.
- No minimum flow rate: get hot water even at very low flow rates of 0.1 or 0.2 GPM
- Eliminates any hot/cold/hot stacking, the so-called "Cold Water Sandwich".
- Saves additional money and time by eliminating the pump purchase cost and on-site installation costs.
- Prevents heat exchanger from freezing.



#### Residential Condensing Tankless Water Heaters w/ Built-In Circulation Pump & Mini Buffer Tank

Part #	Mfg #	Gas Type	Min Input BTUH	Max Input BTUH	Dimensions	Vent Size	Energy Factor	Approx Ship Wt	Price
935031	NR-180A-NG	NG	15,000	150,000	17" x 28" x 14"	3"	0.94	77 lbs	1291.67
931555	NR-210A-NG	NG	17,000	175,000	17" x 28" x 15"	4"	0.94	86 lbs	1455.56
932541	NR-240A-NG	NG	17,000	199,000	17" x 28" x 15"	3"	0.95	86 lbs	1618.06

#### Commercial Condensing Tankless Water Heaters w/ Built-In Circulation Pump & Mini Buffer Tank

Part #	Mfg #	Gas Type	Min Input BTUH	Max Input BTUH	Dimensions	Vent Size	Energy Factor	Approx Ship Wt	Price
919757	NP-240-A-NG	NG	17,000	199,000	17" x 28" x 15"	3"	0.95	86 lbs	1716.67

Heating



## Water Heaters



### Combination Heaters

#### Navien Condensing Combination Natural Gas Water/Space Heater

- Endless hot water supply (2~3 showers at the same time)
- Ultra condensing efficiency (CAFUE=0.91)
- Space saving design
- 3" SCH 40 PVC venting up to 100' with a maximum of 6 elbows
- Optimal and stable operation
- Eco friendly Navien technology
- Easy installation
- Intelligent Remote Control System (include in every unit)
  - Aesthetic Appearance Suitable for Any Household's interior Design
  - High-Precision Water Temperature Control in 1-Degree Increments
  - 24 Hour Time Scheduling for Space Heating
  - Easy-to-Use Button Type Control
  - Easy to read LCD display



Heating

Part #	Mfg #	Gas Type	Min Input BTUH	Max Input BTUH	Dimensions	Vent Size	CAFUE %	Approx Ship Wt	Price
934625	CH-180-NG	NG	17,000	150,000	17" x 28" x 12"	3"	91%	74 lbs	1861.12
937209	CH-210-NG	NG	20,000	175,000	17" x 28" x 12"	3"	92%	84 lbs	2019.45
937210	CH-240-NG	NG	20,000	199,000	17" x 28" x 12"	3"	91%	84 lbs	2179.17
951343	CH-240-NG*	NG	20,000	199,000	17" x 28" x 12"	3"	91%	84 lbs	Call

\* ASME Series

### Tankless Water Heater Accessories

#### Watts TWH Series Tankless Water Heater Valves

- Series TWH tankless water heater valves are designed to simplify the installation, maintenance and operation of tankless water heaters.
- 3/4" FPT unions for connection to water heater
- 3/4" FPT/sweat unions for connection to water lines
- Full-port, quarter-turn ball valve with color-coded tee handle and union
- Quarter-turn purge and drain valve with hose connection and tethered brass cap
- Hot and cold valves certified to NSF/ANSI 61
- Staggered connection points for ease of installation and access
- Valves are suitable for most tankless installations
- No additional adapters required
- 600 WOG rated



Part #	Mfg #	Model	Size	Price
934521	0100132	TWH-FT-HCN-RV	3/4in Kit, with Relief Valve - Domestic Water Side Only	69.10
937529	0100135	TWH-UTS-HCN	1in Kit, less Relief Valve	97.56
946618	0100136	TWH-UTS-HCN-RV	1in Kit, with Relief Valve	144.80

Prices & specifications are subject to change.

Our office hours are 7am to 4:30pm and counter hours 6am to 4:30pm Monday through Friday.



# Water Heaters



## Noritz Tankless Commercial Water Heaters

### Noritz NC380 Series ASME Tankless Commercial Water Heater

- *Standard Input - gas consumption ranges from 22,500 BTU/h to 380,000 BTU/h*
- *Compact Design - ANSI Z21.10.3/CSA 4.3 certified design that can be wall-mounted indoors or installed outdoors using optional Vent Cap*
- *Durable Stainless Steel Casing*
- *Heat Exchanger - manufactured with commercial grade copper, 25% thicker piping than standard models*
- *Venting - available in standard power vent model that requires 5" Category III stainless steel pipe*
- *Direct Electronic Ignition*
- *Multi-System Capability - units can be linked together by using either the optional 2-unit Quick Connect or multi-unit System Controller for up to 24 units.*
- *Fully Modulating - BTU input can range from 22,500 to 9.1 million BTU/h (for 24-unit Multi-System)*
- *Thermal Efficiency - 80% efficient for use with natural gas and 84% for propane*
- *Temperature Controls - includes remote thermostat that can precisely adjust the output temperature from 100°F to 180°F*
- *Safety Devices - Flame Sensor, Overheat Prevention Device, Lightning Protection Device, Freeze Protection*
- *Five Year Limited Heat Exchanger Warranty for Commercial Use, Five Year Limited Parts Warranty*
- *ASME Certified - all models are certified by ASME and the National Board*



Heating

Part #	Mfg #	Flow Rate (GPM)	Flow Rate (GPH)	Power Supply	Temperature Settings	Price
933504	NC380-SV-ASME	8.9 @ 70°	534 @ 70°	120VAC (60Hz)	100-150°F (In 5°F intervals), 160, 170, *180°F (14 Options)	5249.00

### Noritz NC250 Series ASME Tankless Commercial Water Heater

- *Standard Input - gas consumption ranges from 11,000 BTU/h to 250,000 BTU/h*
- *Durable Stainless Steel Casing*
- *Heat Exchanger - manufactured with commercial grade copper, 25% thicker piping than standard models*
- *Venting Options - available in power or direct vent model that requires 4" Category III stainless steel pipe*
- *Direct Electronic Ignition*
- *Multi-System Capability - units can be linked together by using either the optional 2-unit Quick Connect or multi-unit System Controller for up to 24 units.*
- *Fully Modulating - BTU input can range from 11,000 to 6 million BTU/h (for 24-unit Multi-System) with stable combustion provided by the industry's 1st Dual-Flame Burner*
- *Thermal Efficiency - 84% efficient for use with natural gas or propane*
- *Temperature Controls - includes remote thermostat that can precisely adjust the output temperature from 100°F to 180°F*
- *Safety Devices - Flame Sensor, Overheat Prevention Device, Lightning Protection Device, Freeze Protection*
- *Five Year Limited Heat Exchanger Warranty for Commercial Use, Five Year Limited Parts Warranty*
- *ASME Certified - all models are certified by ASME and the National Board*



Part #	Mfg #	Flow Rate (GPM)	Flow Rate (GPH)	Power Supply	Temperature Settings	Price
946602	NC-250-DV-ASME	6.0 @ 70°	360 @ 70°	120VAC (60Hz)	100-150°F (In 5°F intervals), 160, 170, *180°F (14 Options)	3359.00





## Water Heaters



### Noritz NCC199 Series Condensing Tankless Commercial Water Heater

- Standard Input - gas consumption ranges from 11,000 BTUh to 199,900 BTUh
- Durable Stainless Steel Casing
- Heat Exchanger - manufactured with commercial grade copper, 25% thicker piping than standard models
- Venting Options - available in Standard (-SV) or Direct Vent (-DV) model that can use either Schedule 40 PVC/CPVC or Category III stainless steel pipe
- Direct Electronic Ignition
- Multi-System Capability - units can be linked together by using either the optional 2-unit Quick Connect or multi-unit System Controller for up to 24 units.
- Fully Modulating - BTU input can range from 11,000 to 4.8 million BTUh (for 24-unit Multi-System) with stable combustion provided by the industry's 1st Dual-Flame Burner
- Thermal Efficiency - fully condensing, 93% efficient for use with natural gas and propane
- Temperature Controls - includes remote thermostat that can precisely adjust the output temperature from 100°F to 180°F
- Safety Devices - Flame Sensor, Overheat Prevention Device, Lightning Protection Device, Freeze Protection, Neutralizer Overfill
- Five Year Limited Heat Exchanger Warranty for Commercial Use, Five Year Limited Parts Warranty



Heating

Part #	Mfg #	Flow Rate (GPM)	Flow Rate (GPH)	Power Supply	Temperature Settings	Price
946608	NCC199-DV	5.3 @ 70°	318 @ 70°	120VAC (60Hz)	100-150°F (In 5°F intervals), 160, 170, *180°F (14 Options)	3199.00

### Noritz NC199 Series Commercial Tankless Water Heater

- Standard Input - gas consumption ranges from 11,000 BTUh to 199,900 BTUh
- Durable Steel Casing with Acryl Coating - manufactured with commercial grade copper, 25% thicker piping than standard models
- Venting Options - available in Outdoor (-OD) or Concentric Direct Vent (-DVC) model that requires 5/3 in. Noritz concentric stainless steel pipe.
- Direct Electronic Ignition
- Multi-System Capability - units can be linked together by using either the optional 2-unit Quick Connect or multi-unit System Controller for up to 6 units.
- Fully Modulating - BTU input can range from 11,000 to 1.2 million BTUh (for 6-unit Multi-System) with stable combustion provided by the industry's 1st Dual-Flame Burner
- Thermal Efficiency- 84% efficient for use with natural gas or propane
- Temperature Controls - includes remote thermostat that can precisely adjust the output temperature from 100°F to 180°F
- Safety Devices - Flame Sensor, Overheat Prevention Device, Lightning Protection Device, Freeze Protection
- Five Year Limited Warranty



Part #	Mfg #	Flow Rate (GPM)	Flow Rate (GPH)	Power Supply	Temperature Settings	Price
946611	NC199-DVC	4.8 @ 70°	288 @ 70°	120VAC (60Hz)	100-150°F (In 5°F intervals), 160, 170, *180°F (14 Options)	1999.00

Prices & specifications are subject to change.

You can check stock availability, pricing and place orders online at [www.MetPipe.com](http://www.MetPipe.com).



# Water Heaters

## Noritz Accessories

### Wall Kits for NC199 Water Heaters

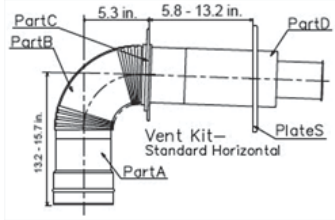

- Push-on connection.
- Single-wall penetration.
- No need to cut- adjustable for easy installations.
- Zero clearance to combustibles.
- Use of superior anti-corrosion material 316L for outlet port.
- Heat and chemical resistant fluorine rubber O-ring for secure sealing.

Part #	Mfg #	Description	Price
946612	CVK-H	Wall Kit for 5" - 13" Walls	89.83
946808	CVK-H2	Wall Kit for 10.3" - 17.8" Walls	Call

### Noritz SC-201-6M Tankless Water Heater System Control

- The System Controller is necessary when you're connecting 3 or more identical units together.
- This controller allows multiple heaters to communicate off of one remote controller (up to 6 units)



Part #	Mfg #	Description	Price
946817	SC-201-6M	For NC380, NC250 or NCC199	Call
946818	SC-201-6M-EXT-PVC	For NC199	433.33

### PVC Adapter for NC199 Heaters

- When attaching 3" PVC piping to a Noritz tankless water heater, a PVC adapter must be used. This adapter is not supplied with the water heater and must be purchased separately. It is not necessary to use cement or silicone on this adapter as it is self-sealing.



Part #	Mfg #	Description	Price
946614	VP4X3	4" x 3" Adapter	74.39
946616	VP4X4	4" x 4" Adapter	86.34

### Plastic Vent Termination Hood Kit



- 3" and 4" in one design
- Hood / Louver Convertible
- Fits Schedule 40 PVC & CPVC
- Direct connection to PVC pipe

Part #	Mfg #	Description	Price
946814	PVT-HL	Termination hood & louver kit (Fits 3" & 4" PVC)	25.83



**FREE Local Delivery**

Heating



## Water Heater Accessories



### Potable Water Expansion Tanks

#### Series PLT Potable Water Expansion Tanks

- Designed to absorb the increased volume of water created by thermal expansion and to maintain balanced pressure throughout the potable water supply system
- Tanks feature a pre-pressurized steel tank with an expansion membrane that prevents contact of the water with the air in the tank.
- May be used with all types of Direct Fired Hot Water Heaters (gas, oil or electric) and hot water storage tanks
- IAPMO listed and ANSI/NSF 61 certified
- Maximum Pressure: 150psi (10 bar)



Part #	Mfg #	Volume	Width	Height	Price
876646	PLT-5	2.1 gal	8"	11"	35.20
898391	PLT-12	4.5 gal	10.5"	13-1/2"	44.29

### Non-Potable Water Expansion Tanks

#### Series ETX Non-Potable Water Expansion Tanks

- For use in commercial and residential closed loop hydronic heating system piping to control the thermal expansion of hot water and maintain system pressure below the relief setting of the relief valve.
- The pre-pressurized steel tank features a durable expansion membrane that prevents contact of the water with the air in the tank
- This rugged diaphragm minimizes loss of the air change and ensures long and trouble-free life for the system
- Maximum Pressure: 75psi (5.3 bar) for ETX and 100psi (6.9 bar) for ETSX



Part #	Mfg #	Volume	Width	Height	Price
931006	ETX-15	2.1 gal	8"	12-1/2"	28.86
931008	ETX-30	4.5 gal	11"	14"	30.79
931011	ETX-60	6 gal	11-3/8"	17-3/16"	63.96
931012	ETX-90	15 gal	16"	20-13/16"	98.61
937738	ETSX-30	15 gal	16"	21-11/16"	240.42
931014	ETSX-40	20 gal	16"	28-13/16"	245.82
931015	ETSX-60	33 gal	16"	42-13/16"	368.94
931016	ETSX-90	44 gal	21"	36-3/16"	670.74
931021	ETSX-110	62 gal	21"	47-7/8"	726.65

### Air Purgers

#### Cast Iron Air Separators / Air Purgers

- Series AS Air Separator is designed for efficient separation of air from water in Hydronic Heating Systems
- 1/2" (15mm) tapings on each side for fill valve piping
- Heavy cast iron construction
- Furnished with tapings for expansion tank and air vent



Part #	Mfg #	Size	Price
902989	AS-M1	1"	16.68
903164	AS-M1	1-1/4"	16.69
932278	M1	1-1/2"	43.42
932280	M1	2"	43.45
932281	M1	2-1/2"	185.43



### FloodStopper™ System

- Fully automated water leak detection & control system
- Provides 24/7 protection
- Can reduce insurance premiums
- Includes:
  - Honeywell 3/4" valve & actuator
  - Hardwired sensors
  - Wireless transmitter with 4 sensors



Part #	Mfg #	Description	Price
180046	FSS-1ZMAS	Single-Zone Control Panel	495.00



## Water Heater Accessories

### Water Heater Electric Alarm/Shut-Off System

- FloodMaster's FM-094 Water Heater Alarm/Shut-Off System is ideal for minimizing water damage when hot water heater or water tank failures occur. This is accomplished by simply installing the FM-094 to the feed water line for the water tank.
- Easy installation
- All corrosion-free materials
- Can be reinstalled tank to tank
- Automatic shut-off and audible alarm
- AC power
- Transformer cUL listed; actuator CE listed
- Reduce/eliminate water damage and insurance claims
- Turns off water source automatically, even if you aren't home to hear the alarm
- When alarm sounds, fix problem and reset unit for continued protection
- Can interface into a home security alarm system
- Power cord: 12 feet; Sensor cord: 8 feet
- Transformer, 120 VAC



Part #	Mfg #	Description	Price
236267	FM-094	Electric Alarm/Shut-Off System	277.04



### Water Heater Pans Aluminum Water Heater Pans

- Manufactured from .032 prime aluminum & are expertly worked to exact specifications under strict quality control
- Exposed edges have been rolled to protect the installer from injury
- Meets requirements of Southern Building Code
- Recommended for gas or electric heaters
- Includes 1in CPVC fitting



Part #	Mfg #	Size	Fitting	Price
114013	34153	24"	1" CPVC	28.10
860183	34085	30"	1" CPVC	44.68

### Plastic Polymer Water Heater Pans

- Manufactured from semi-flexible, tough & durable .0625" plastic polymer
- Will not rust or corrode
- Meets requirements of Southern Building Code
- Pans pre-drilled to accommodate fittings
- Recommended for electric water heaters
- Includes 1in PVC fitting



Part #	Mfg #	Size	Fitting	Price
14911	34060	18"	1" PVC	11.71
14912	34061	20"	1" PVC	9.01
14913	34062	22"	1" PVC	9.31
14914	34063	24"	1" PVC	10.19
159764	34064	26"	1" PVC	10.75
14915	34065	30"	1" PVC	19.69

Heating

# STORE HOURS

Monday - Friday

6AM - 4:30PM

Prices & specifications are subject to change.



# Boilers



## CG Series Gas Boilers

- Limited lifetime warranty on cast iron sections
- Designed for forced hot water heating systems
- 20' Chimney recommended; chimney height may be reduced to 10' in special cases where surrounding conditions permit
- Cast iron sections with elastomer sealing rings
- Combination pressure-temperature gauge
- Temperature & pressure gauge installed
- Jacket is 23-1/4" front-to-back
- 30 psi ASME Relief valve (boiler sections tested for 50 psi working pressure)

### CGa Series - Natural Draft - Spark Ignition Natural Gas Only - Water Only

- Automatic vent damper
- Electronic pilot control system
- Weil-McLain control module and ignition control with indicator/diagnostic lights
- Plug-in connector and wiring



Heating

Part #	Mfg #	Boiler Model	AGA Input BTUH	% DOE Seasonal Efficiency (AFUE)	DOE Heating Capacity BTUH	Net I=B=R Rating BTUH	Approx Ship Wt	Chimney Size	Price
190120	381-357-308	CGa-3-PIDN	70,000	84.0	59,000	51,000	200 lbs	4" ID x 20'	1684.05
190119	381-357-309	CGa-4-PIDN	105,000	84.0	88,000	77,000	240 lbs	5" ID x 20'	1843.62
189464	381-357-310	CGa-5-PIDN	140,000	83.5	117,000	102,000	280 lbs	6" ID x 20'	2075.20
190118	381-357-311	CGa-6-PIDN	175,000	83.2	146,000	127,000	325 lbs	6" ID x 20'	2385.33
189463	381-357-313	CGa-8-PIDN	245,000	82.7	204,000	177,000	425 lbs	7" ID x 20'	2938.49

### CGi - Series 2 - Direct Exhaust (Induced Combustion) - Natural Draft - Spark Ignition

- Electronic pilot control system
- Weil-McLain control module and ignition control with indicator/diagnostic lights
- High-grade stainless steel burners



### Natural Gas Only - Water Only

Part #	Mfg #	Boiler Model	AGA Input BTUH	% DOE Seasonal Efficiency (AFUE)	DOE Heating Capacity BTUH	Net I=B=R Rating BTUH	Approx Ship Wt	Minimum Vent Size	Price
140621	381-355-045	CGi-3-PIN	60,000	85.1	51,000	45,000	200 lbs	4" ID	1792.07
140622	381-355-046	CGi-4-PIN	100,000	84.0	85,000	74,000	240 lbs	5" ID	1963.91
140623	381-355-047	CGi-5-PIN	120,000	83.3	100,000	87,000	280 lbs	5" ID	2208.58
140624	381-355-048	CGi-6-PIN	167,000	83.3	140,000	122,000	325 lbs	5" ID	2490.07
196687	381-355-050	CGi-8-PIN	233,000	82.7	194,000	169,000	425 lbs	5" ID	3065.33

Prices & specifications are subject to change.



# Boilers

## GV90+ Series Gas Boilers

### Weil-McLain GV90+ High Efficiency Gas Power Vented Boiler (Water)

- 91% AFUE efficient
- Durable cast iron primary heat exchanger
- Condensing stainless steel secondary heat exchanger
- Unique 7 pass heat exchanger design maximizes heat transfer
- Vents with PVC
- Multiple venting options (direct vent, direct exhaust, concentric)
- Easy conversion to propane (kit included)



Part #	Mfg #	Boiler Model	AGA Input MBH	DOE Heating Capacity MBH	Net I=B=R Rating MBH	Vent Size	Approx. Ship Weight	Price
955204	382-200-601	GV90+4	105,000	97,000	84,000	3"	353 lbs	Call
951318	382-200-602	GV90+5	140,000	130,000	113,000	3"	423 lbs	Call

Heating

## Ultra Series 3 - High Efficiency Gas Boilers with 20-100% Modulation

- 15-Year warranty on heat exchanger
- 5-Year warranty on parts and labor
- Direct spark ignition
- PhD Technology® - Precision Hydronic Data
- Cast aluminum block
- Drain valve
- Stainless steel burner with woven steel fiber mesh
- Variable speed blower assembly
- Gas/air ratio venturi with air silencer
- Negative pressure regulation gas valve
- 50VA Transformer
- Combination temperature and pressure gauge
- Temperature sensors for outdoors, flue gas and outlet & return water
- 30 psi ASME Relief valve



## Natural Gas Boilers

Part #	Mfg #	Boiler Model	AGA Input BTUH	DOE Heating Capacity BTUH	Net I=B=R Rating BTUH	DOE AFUE	Approx Ship Wt	PVC/ABS Vent Size	Price
906909	383-500-700	U-80	80,000	71,000	62,000	95.2	149 lbs	3"	3625.04
232333	383-500-702	U-105	105,000	94,000	81,000	95.3	154 lbs	3"	4017.00
219831	383-500-703	U-155	155,000	139,000	123,000	95.6	193 lbs	3"	4068.40
219836	383-500-704	U-230	230,000	207,000	183,000	95.4	204 lbs	3" or 4"	5097.15
234201	383-500-705	U-310	310,000	289,000	252,000	96.4	254 lbs	4"	6496.43

Prices & specifications are subject to change.



## Boilers



### Oil Boilers Ultra Oil-Fired Water Boiler

- Limited lifetime warranty on boiler sections
- 86+ AFUE
- Reversible swing away burner door
- 3-Pass cast iron heat exchanger with captured elastomer seals
- Chimney vent with no external draft inducer needed
- EnviraCOM™ ready Honeywell L7248 electronic oil aquastat
- Beckett NX burner with Weil-McLain designed burner cover
- Standard equipment Includes:
  - Service switch
  - Temperature/pressure gauge
  - Boiler drain
  - Barometric damper
  - 30 psi Relief valve



#### Ultra Oil Boiler Less Burner - Chimney Vent

Part #	Mfg #	Boiler Model	I=B=R Burner Capacity	CSA Input BTUH	DOE Heating Capacity BTUH	Net I=B=R Rating BTUH	Approx Shp Wt	Price
861883	386-901-000	UO-3-CV	1.00 gph	140,000	122,000	106,000	636 lbs	1694.69
861885	386-901-002	UO-5-CV	1.40 gph	196,000	172,000	150,000	852 lbs	2296.95

#### Ultra Oil Parts

Part #	Mfg #	Description	Price
861896	386-902-007	UO-3 Low Firing Rate Kit for 0.80 gph Only (Includes Blanket, Water Glass and Nozzle)	14.73
861894	386-902-010	Vent Termination Kit	369.87
861895	386-902-012	Flexible Vent Pipe	292.95

Heating

## Custom Pipe Labels WHILE YOU WAIT!

See page 362 for more details.





## Boilers

### WGO Gold Series 3 - Oil-Fired Water Boiler

- Limited lifetime warranty on boiler sections
- Factory water tested
- Jacketed block assembly
- Cast iron sections with Weil-McLain captured seals
- Refractory combustion chamber with high temperature target wall
- Convertible flue (rear or top)
- Full swing-away burner door
- Insulated jacket with quick inspection opening cover
- Drain valve
- Combination pressure-temperature gauge
- Electrical junction box with wiring harnesses
- Service switch mounted on junction box cover plate
- High limit temperature control with circulator relay
- Balanced draft damper
- I=B=R Chimney size: 8" x 8" x 15'
- 30 psi ASME Relief valve

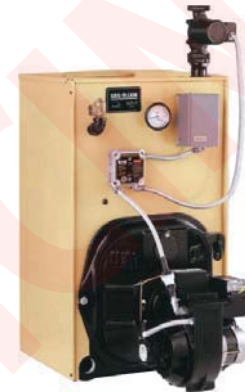

### Packaged Boiler Less Burner and Burner Controls

- Factory assembled and wired with jacket, circulator and controls.
- Circulator included and shipped loose for mounting on supply or return

Part #	Mfg #	Boiler Model	I=B=R Burner Capacity	DOE Heating Capacity BTUH	Net I=B=R Ratings BTUH	DOE Seasonal Efficiency % AFUE	Approx Ship Wt	Price
203513	386-700-827	P-WGO-2	0.70 gph	86,000	75,000	85.4	472 lbs	1456.57
172730	386-700-828	P-WGO-3	0.95 gph	115,000	100,000	85.3	525 lbs	1791.25
172732	386-700-829	P-WGO-4	1.20 gph	145,000	126,000	85.0	568 lbs	2089.92
172733	386-700-830	P-WGO-5	1.45 gph	175,000	152,000	85.0	683 lbs	2403.33
172734	386-700-831	P-WGO-6	1.75 gph	212,000	184,000	85.0	712 lbs	2647.18

### Beckett AFG Oil Burners

Part #	Mfg #	Model	Description	Price
52692	386-700-396	GO-3	For WGO-3 Oil Boiler	410.79
52696	386-700-400	GO-4	For WGO-4 Oil Boiler	410.79
52697	386-700-404	GO-5	For WGO-5 Oil Boiler	410.79
52698	386-700-408	GO-6	For WGO-6 Oil Boiler	410.79

Heating





## Boilers



### WTGO Gold Series 3 - Oil-Fired Water Boiler with Tankless Heater Opening

- Limited lifetime warranty on boiler sections
- Jacketed block assembly
- Refractory combustion chamber with height temperature target wall
- Convertible flue (rear or top)
- Full swing-away burner door
- Insulated jacket with quick inspection opening cover
- Cast iron sections with Weil-McLain captured seals
- Drain valve
- Pressure/temperature gauge
- Electrical junction box with wiring harnesses
- Service switch mounted on junction box cover plate
- Applicable temperature control with circulator relay
- I=B=R Chimney size: 8" x 8" x 15'
- Balanced draft damper
- 30 psi ASME Relief valve



### Packaged Boiler with Tankless Heater - Less Burner & Burner Controls

- Circulator included and shipped loose for mounting on supply or return
- High-low limit control with circulator relay
- Factory assembled and wired with jacket, circulator and controls

Part #	Mfg #	Boiler Model	I=B=R Burner Capacity	DOE Heating Capacity BTUH	Net I=B=R Ratings BTUH	DOE Seasonal Efficiency % AFUE	Approx Ship Wt	Price
172718	386-700-832	P-WTGO-3	0.95 gph	115,000	100,000	85.3	542 lbs	2021.19
165509	386-700-807	P-WTGO-3L	0.95 gph	114,000	99,000	84.5	542 lbs	2026.92
172722	386-700-833	P-WTGO-4	1.20 gph	145,000	126,000	85.0	583 lbs	2321.50
172725	386-700-834	P-WTGO-5	1.45 gph	175,000	152,000	85.0	683 lbs	2632.45
172729	386-700-835	P-WTGO-6	1.75 gph	212,000	184,000	85.0	718 lbs	2908.22

Heating

CELEBRATING  
**75** YEARS  
 1934 • 2010

Metropolitan Pipe recently celebrated 75 years of operation. Our staff, with over a century of combined experience, is always ready to tackle your next job. No one knows the industry better!



## Boilers

### SGO Gold Series 3 - Oil-Fired Steam Boiler with Tankless Heater Opening

- 10-Year limited warranty on boiler sections
- Cast iron sections with Weil-McLain capture seals
- Jacketed block assembly
- Refractory combustion chamber with high temperature target wall
- Convertible flue (top or rear) & greater opening cover plate
- Full swing-away burner door
- Insulated jacket with quick inspection opening cover
- Steam pressure gauge, siphon & drain valve
- Gauge glass, cocks and guard
- Electrical junction box with wiring harness & service switch mounted on junction box cover plate
- Balanced draft damper
- I=B=R Chimney size: 8" x 8" x 15'
- 15 psig ASME Safety valve (boiler sections tested for 15 psig steam working pressure)



#### Packaged Boiler Less Burner

- Factory assembled and wired with jacket and controls
- Low water cut-off (float or probe type)

Part #	Mfg #	Boiler Model	I=B=R Burner Capacity	DOE Heating Capacity BTUH	Net I=B=R Rating - Steam Sq Ft/ BTUH	DOE Seasonal Efficiency % AFUE	Approx Ship Wt	Price
192374	386-700-819	P-SGO-3-S	0.95 gph	114,000	354/85,000	84.1	535 lbs	1892.72
174723	386-700-820	P-SGO-4-S	1.25 gph	144,000	450/108,000	84.0	640 lbs	2194.67
174724	386-700-821	P-SGO-5-S	1.50 gph	174,000	546/131,000	83.9	735 lbs	2504.80
172738	386-700-822	P-SGO-6-S	1.80 gph	210,000	658/158,000	83.7	830 lbs	2748.65

#### Carlin Oil Burners

Part #	Mfg #	Description	Price
134779	386-700-428	Carlin Oil Burner	515.00
134780	386-700-432	Carlin Oil Burner	515.00
134803	386-700-436	Carlin Oil Burner	515.00
134804	386-700-440	Carlin Oil Burner	515.00

Heating



**Metropolitan Pipe** is proud to be a member of the nationwide *Embassy Group*. Our participation in this group allows us to extend better pricing and stock availability to you.

Prices & specifications are subject to change.



# Boilers



## Knight™ Wall Hung High Efficiency Condensing Natural Gas Boiler

- Energy Star™ Qualified§
- SMART SYSTEM Digital Operating Control
- Multi-Colored Graphic LCD Display with Navigation Dial and Soft Keys
- 96% DOE AFUE Efficiency
- Modulating Burner with 5:1 Turndown
- Direct-Spark Ignition
- Low-NOx Operation
- Field Convertible from Natural to LP Gas
- ASME Stainless Steel Heat Exchanger
- 30 psi ASME Relief Valve
- Vertical & Horizontal Direct-Vent
- PVC, CPVC or SS Venting up to 100 feet
- Factory Supplied Sidewall Vent Termination
- Smart System Control
- Condensate Trap
- Adjustable High Limit w/Manual Reset
- Wall-Mount Bracket
- Zero Clearances to Combustible Materials
- 12-Year Limited Warranty

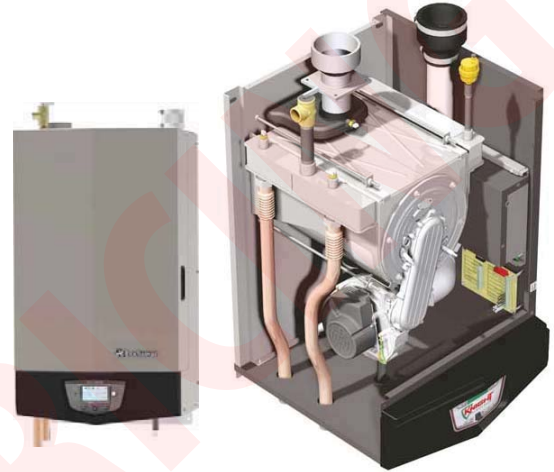

Heating

Part #	Mfg #	Input MBH Min	Input MBH Max	AFUE %	Heating Capacity MBH	Net I=B=R MBH	Vent Size	Ship Weight	Price
944343	WHN055	11,000	55,000	96%	51,000	44,000	2"	139 lbs	3868.00
944344	WHN085	17,000	85,000	96%	79,000	69,000	2"	142 lbs	4278.00
944345	WHN110	22,000	110,000	96%	102,000	89,000	3"	159 lbs	4726.00
944346	WHN155	31,000	155,000	96%	144,000	125,000	3"	166 lbs	5384.00
944347	WHN199	40,000	199,000	96%	186,000	162,000	3"	175 lbs	6077.00
944348	WHN285	57,000	285,000	96%	265,000	230,000	3"	184 lbs	8404.00
944349	WHN399	80,000	399,000	95%	379,000	330,000	4"	213 lbs	11070.00



Prices & specifications are subject to change.

Our faucet parts counter is one of the largest in the Boston area with thousands of parts in stock!



## Boilers

### Knight XL™ High Efficiency Commercial Gas Boiler

- Up to 94.6% Thermal Efficiency
- Modulating Burner with 5:1 Turndown
- SMART SYSTEM Digital Operating Control
- Multi-Colored Graphic LCD Display w/ Navigation Dial
- Direct-Spark Ignition
- Low NOx Operation
- Sealed Combustion
- Low Gas Pressure Operation
- ASME Certified, "H" Stamped, Stainless Steel, Gasketless Heat Exchanger
- 160 psi Working Pressure, 50 psi ASME Relief Valve
- Vertical & Horizontal Direct-Vent
- PVC, CPVC or AL29-4C Category IV venting up to 100 feet
- Factory Supplied Sidewall Vent Termination
- Smart System Control
- Adjustable High Limit w/ Manual Reset
- Zero Clearances to Combustible Material
- 10 Year Limited Warranty (See Warranty)



Heating

Part #	Mfg #	Input MBH Min	Input MBH Max	Thermal Efficiency	Output MBH	Net I=B=R MBH	Vent Size	Ship Weight	Price
940529	KBN400	80,000	399,000	93.3%	372,000	324,000	4"	280 lbs	11071.00
938969	KBN501	100,000	500,000	93.3%	467,000	406,000	4"	310 lbs	14378.00
938166	KBN601	120,000	600,000	94.6%	567,000	493,000	4"	340 lbs	17384.00
942962	KBN701	140,000	700,000	94.3%	660,000	574,000	6"	370 lbs	20450.00
943064	KBN801	160,000	800,000	94.0%	752,000	654,000	6"	405 lbs	23896.00



### Refined Design Puts More Control and Information at your Fingertips

- Multi-Color Graphic LCD Display
- Navigation Dial
- USB Port
- Ability to control up to three different setpoint temperatures
- Modbus Capability (Optional)
- DHW Modulation Limiting
- DHW Night Setback\*



## Boilers



### Sync™ High Efficiency Commercial Condensing Gas Boiler

- Up to 96.2% Thermal Efficiency
- SMART TOUCH™ Touchscreen Operating Control
- Full-Color Touchscreen LCD Display
- Modulating Burner with 10:1 Turndown
- Direct-Spark Ignition
- Low NOx Operation
- Sealed Combustion
- Low Gas Pressure Operation
- Vertical & Horizontal Venting
- Category IV Venting up to 100 Feet PVC, CPVC or AL29-4C Vent Material
- Sidewall Vent Terminations Provided
- ASME Stainless Steel Heat Exchanger, "H" Stamped
- Gasketless Design
- 160 psi Working Pressure
- Adjustable High Limit with Manual Reset
- Low Water Cutoff with Manual Reset & Test
- Low Air Pressure Switch
- High & Low Gas Pressure Switches with Manual Reset
- Two Easy Access Terminal Strips
- Zero Clearance to Combustible Material
- Approved for Combustible Floor Installation
- 1 Year Warranty on Parts, 10 Year Limited Warranty



**SMART TOUCH™**

Heating

Part #	Mfg #	Input MBH Min	Input MBH Max	AHRI Thermal %	Output MBH	Net I=B=R MBH	Vent Size	Ship Weight	Price
929619	SBN1000	100,000	999,000	94.1%	941,000	818,000	6"	786 lbs	34130.00
925682	SBN1300	130,000	1,300,000	95.4%	1,240,000	1,078,000	6"	856 lbs	39239.00
931187	SBN1500	150,000	1,500,000	96.2%	1,443,000	1,255,000	6"	926 lbs	42233.00



**SMART TOUCH™**



# Boilers

## Crest™ High Efficiency Commercial Condensing Gas Boiler

- 92% Thermal Efficiency (AHRI)
- Up to 99% Thermal Efficiency in Low Temperature Applications
- SMART TOUCH™ Touchscreen Operating Control
- Full-Color 8" Touchscreen LCD Display
- Direct-Spark Ignition
- Low-NOx Operation
- Sealed Combustion
- Low Gas Pressure Operation
- Vertical or Horizontal Venting Category IV up to 100 Feet
- ASME "H" Stamped Heat Exchanger
- 316L Stainless Steel Fire Tubes
- 160 psi Working Pressure
- Adjustable High Limit with Manual Reset
- Low Water Cutoff with Manual Reset & Test
- High & Low Gas Pressure Switches w/Manual Reset
- Low Air Pressure Switches
- Inlet & Outlet Temperature Sensors
- High & Low Voltage Terminal Strip
- 50 psi ASME Relief Valve
- Temperature & Pressure Gauge
- Zero Clearances to Combustible Materials
- 10-Year Limited Warranty, 1-Year Warranty on Parts



**SMART TOUCH™**

Heating

Part #	Mfg #	Input MBH Min	Input MBH Max	AHRI Thermal %	Output MBH	Net I=B=R MBH	LP Gas Turndown	Vent Size	Ship Weight	Price
944127	FBN1500	60,000	1,500,000	92.0%	1,380,000	1,200,000	25:1	7"	1,900 lbs	40873.00
944128	FBN2000	80,000	1,999,000	92.0%	1,840,000	1,600,000	25:1	8"	2,150 lbs	49444.00
944129	FBN2500	125,000	2,500,000	92.0%	2,300,000	2,000,000	20:1	9"	2,560 lbs	64892.00
944130	FBN3000	150,000	3,000,000	92.0%	2,760,000	2,400,000	20:1	10"	2,920 lbs	72557.00
944131	FBN3500	200,000	3,500,000	92.0%	3,220,000	2,800,000	18:1	10"	3,225 lbs	90865.00



**SMART TOUCH™**



# Boilers



## Commercial Boilers Ultra Commercial Boilers

- 93.9% Thermal Efficiency
- 94% Combustion Efficiency
- CSD-1 Compliant is Standard
- Lightweight and Requires Minimal Clearance
- Fast & Easy Out of the Box Installation
- Low NOx Certified
- PVC Venting for Direct Vent and Direct Exhaust
- Compact Design Packaged Boiler
- 20% - 100% Modulation
- U-Control Flexibility



### Efficiency Rating Chart

Part #	Mfg #	CSA Input Max (MBH)	CSA Gross Output	Net I=B=R	IBR Thermal	IBR Combustion	Min. Gas Pressure	Price
923252	550	550	517	445	93.90%	94.70%	3.5"	12474.06
923263	750	750	702	605	93.60%	94.00%	3.5"	14978.85

## 80 Series Gas/Oil Boiler, Forced or Balanced Draft (Steam or Water)

- Field convertible flue
- Available as knockdown or packaged, water or steam and with or without a burner
- Jacket side panels lift off for easy installation - no tools needed
- Commercial light oil, gas and gas-light oil boiler
- 80% Thermal Efficiency



### Efficiency Rating Chart

Part #	Mfg #	Light Oil (GPH)	Gas Input (MB)	DOE Heating Capacity (MBH)	Net I=B=R Ratings			Min. Chimney Size	Price
					Steam (Sq Ft)	Steam (MBH)	Water (MBH)		
Call	380	2.4	346	278	867	208	242	6"	Call
Call	480	3.4	491	396	1238	297	344	7"	Call
Call	580	4.5	639	515	1608	386	448	8"	Call
Call	680	5.5	787	634	1983	476	551	8"	Call
Call	780	6.5	935	753	2354	565	655	9"	Call
Call	880	7.5	1082	872	2725	654	758	10"	Call
Call	980	8.5	1230	991	3096	743	862	10"	Call
Call	1080	9.6	1378	1110	3471	833	965	10"	Call
Call	1180	10.6	1526	1229	3842	922	1069	10"	Call
Call	1280	11.6	1674	1348	4242	1018	1172	12"	Call

Heating

Prices & specifications are subject to change.



## Boilers

### 88 Series Gas/Oil Boiler, Forced or Balanced Draft (Steam or Water)

- 85.6% Thermal efficiency
- On/Off, Low/High/Off, Low/High/Low, or Full Modulation
- With or without tankless heater
- Packaged or knock-down
- Gas, Oil or Gas/Oil
- Complies to LEED
- Water or Steam
- 1010 - 5845 MBH Input
- 24-145 H.P.
- Single or multiple boiler systems



Efficiency Rating Chart

Part #	Mfg #	Light Oil (GPH)	Gas Input (MB)	Steam (Sq Ft)	Net I=B=R Ratings		Price
					Steam (MBH)	Water (MBH)	
Call	488R	6.9	996	2583	620	719	Call
Call	488	7	1010	2621	629	730	Call
Call	588	9.4	1356	3521	845	979	Call
Call	688	11.8	1701	4469	1072	1229	Call
Call	788	14.2	2046	5463	1311	1478	Call
Call	888	16.6	2382	6427	1543	1728	Call
Call	988	18.8	2737	7358	1766	1977	Call
Call	988R	20	2887	7763	1863	2086	Call
Call	1088R	20	2887	7763	1863	2086	Call
Call	1088	21.5	3082	8283	1988	2227	Call
Call	1188	23.5	3428	9213	2211	2477	Call
Call	1288	26	3773	10147	2434	2726	Call
Call	1388	28.5	4119	11071	2657	2976	Call
Call	1488	31	4464	12000	2880	3225	Call
Call	1588	33	4809	12925	3102	3475	Call
Call	1688R	34.5	4979	13383	3212	3597	Call
Call	1688	35.5	5155	13854	3325	3724	Call
Call	1788	38	5494	14783	3548	3974	Call
Call	1888	40.5	5845	15713	3771	4123	Call

**Call 1-800-MetPipe today to spec out your Weil-McLain commercial boiler!**

Heating





## Boilers



### 94 Series Gas/Oil Boiler, Forced or Balanced Draft (Steam or Water)

- Hydro-wall design with water circulating completely around the combustion area - no refractory combustion chamber or separate base
- Designed for easy maintenance - all heating surfaces can be cleaned from the left side of the boiler
- Cast iron sections are made gastight with patented sealing rope design
- Short draw rods permit faster, easier assembly of boiler sections
- Simplified piping reduces installation time- no return header and fewer risers
- Light oil, gas and gas-light oil forced draft firing water boiler with cast iron sections
- Burner mounting plate furnished as standard equipment for most models
- H and T-shaped cross sections provide maximum design strength, 80 lbs working pressure available
- 80% Thermal Efficiency



### Efficiency Rating Chart

Part #	Mfg #	Light Oil (GPH)	Gas Input (MB)	DOE Heating Capacity (MBH)	Net I=B=R Ratings			Min. Chimney Size	Price
					Steam (Sq Ft)	Steam (MBH)	Water (MBH)		
Call	H-894	17.6	2540	2028	6563	1575	1763	14	Call
Call	H-994	20	2887	2320	7504	1801	2017	14	Call
Call	H-1094	22.5	3247	2612	8450	2028	2271	16	Call
Call	H-1194	25	3608	2904	9396	2255	2525	16	Call
Call	H-1294	27.5	3969	3190	10321	2477	2774	16	Call
Call	H-1394	30	4330	3480	11258	2702	3026	18	Call
Call	H-1494	32.5	4691	3770	12196	2927	3278	18	Call
Call	H-1494	32.5	4691	3770	12196	2927	3278	18	Call
Call	H-1594	35	5052	4070	13167	3160	3539	18	Call
Call	H-1694	37.5	5412	4360	14104	3385	3791	18	Call
Call	H-1794	40	5773	4650	15042	3610	4043	20	Call
Call	H-1894	42.5	6134	4940	15979	3835	4296	20	Call
Call	H-1994	45	6495	5230	16921	4061	4548	20	Call
Call	H-2094	47.5	6856	5520	17858	4286	4800	20	Call
Call	H-2194	50	7216	5810	18796	4511	5052	20	Call
Call	H-2294	53	7649	6100	19733	4736	5304	22	Call
Call	H-2394	55	7938	6390	20671	4961	5557	22	Call
Call	H-2494	58	8371	6680	21608	5186	5809	22	Call
Call	H-2594	60	8660	6970	22546	5411	6061	22	Call

Heating

**Call 1-800-MetPipe today to spec out your Weil-McLain commercial boiler!**



## Boilers

### LGB Series Atmospheric Gas Boiler (Water or Steam)

- Short draw rods permit faster, easier assembly of boiler sections
- Includes factory-assembled base and burners, and simplified piping for quick and easy installation
- Compact design allows for more piping and venting headroom
- The highest efficiency commercial cast iron atmospheric gas boiler available by Weil-McLain
- Built-in air separator diverts air to the expansion tank
- Gas natural draft water and steam boiler with cast iron sections



### Efficiency Rating Chart

Part #	Mfg #	A.G.A. Input	DOE Heating Capacity (MBH)	Net I=B=R Ratings		Min. Chimney Size	Price	
				Steam (Sq Ft)	Steam (MBH)			Water (MBH)
Call	LGB-4	400	324	1013	243	282	10	Call
Call	LGB-5	520	421	1317	316	366	12	Call
Call	LGB-6	650	527	1645	395	458	12	Call
Call	LGB-7	780	632	1975	474	549	12	Call
Call	LGB-8	910	737	2305	553	641	14	Call
Call	LGB-9	1040	842	2635	632	733	14	Call
Call	LGB-10	1170	948	2965	711	824	16	Call
Call	LGB-11	1300	1053	3290	790	916	16	Call
Call	LGB-12	1430	1158	3620	869	1007	16	Call
Call	LGB-13	1560	1264	3955	949	1099	16	Call
Call	LGB-14	1690	1369	4313	1035	1190	16	Call
Call	LGB-15	1820	1474	4679	1123	1282	17	Call
Call	LGB-17	2080	1685	5408	1298	1465	17	Call
Call	LGB-18	2210	1790	5775	1386	1557	18	Call
Call	LGB-19	2340	1895	6125	1470	1648	18	Call
Call	LGB-20	2470	2001	6471	1553	1740	19	Call
Call	LGB-21	2600	2106	6813	1635	1831	19	Call
Call	LGB-22	2730	2211	7155	1717	1923	19	Call
Call	LGB-23	2860	2317	7496	1799	2014	20	Call
Call	LGB-16	1950	1580	5046	1211	1373	17	Call

Heating

**Call 1-800-MetPipe today to spec out your Weil-McLain commercial boiler!**

Prices & specifications are subject to change.



## Boiler Accessories



### Trufin Tube Internal Tankless Heaters Weil-McLain Tankless Coils

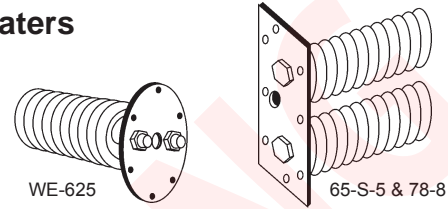

Part #	Mfg #	Capacity	Boiler Series	Notes	Price
38107	WE-625	5 gpm	65-66-68--EG, 42-62 Water Boilers	7" Diameter - 6 BH	279.64
38333	65-S-5	5 gpm	65-66-68--EG--GOLD Steam Boilers	6" x 10" - 8 BH	303.81
195068	78-8	8 gpm	78 Series Steam Boilers	5-1/4" x 10" - 8 BH	484.48

### Condensate Acidic Neutralizing Tubes

#### JM Series Condensate Acidic Neutralizing Tubes

- Residential and commercial flue side neutralizing tubes are designed to raise the PH level of the condensate discharged by high efficiency boilers and warm air furnaces. The condensate traveling through the JJM tubes has it's PH level increased by approximately 10-1,000 times higher towards a more neutral point.
- Channel Strut Base Mounted
- PVC Tubing
- Nylon Barbed Fitting
- Galvanized Strut Clamps, Bolts, and Nuts
- 1/2" and 3/4" Aggregate Calcium Carbonate
- Includes: Mounting brackets, strut clamps, fully charged units, inlet & outlet nylon fittings, and clean-out cap.

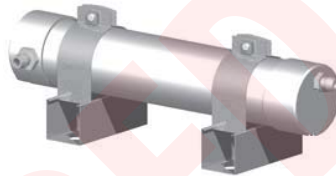

Part #	Mfg #	MBH	GPH	Price
913824	JM-2	200	2	56.00
899515	JM-6	600	6	128.00
920128	JM-10	1,000	10	134.00
902741	JM-20	2,000	20	155.00
912419	JM-30	3,000	30	207.69
925799	JM-40	4,000	40	Call
922324	JM-50	5,000	50	Call

#### Neutralizer Refill Kit

Part #	Mfg #	Description	Price
937995	#2	#2 Neutralizer Refill	Call



**Pipe Fabrication Shop**  
Cutting, threading, grooving, make-on  
and welding - on site!

Heating



## Boiler Controls



### tekmar® Boiler/DHW Controls

#### 260 Boiler Controls

- Microprocessor-based (PID) control
- Regulates supply water temperature from a single boiler based on either outdoor temperature or a DHW demand

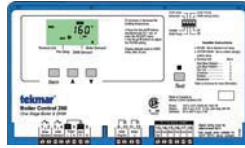

Part #	Mfg #	Description	Price
193282	260	1-Stage Boiler & DHW	437.99

#### 261 Boiler Controls

- Microprocessor-based (PID) 2-stage control
- Regulates supply water temperature from a single 2-stage boiler or (2) 1-stage boilers based on either outdoor air temperature or a setpoint demand

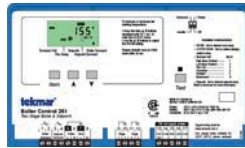

Part #	Mfg #	Description	Price
200741	261	2-Stage Boiler & Setpoint	465.93

#### 264 Boiler Controls

- Microprocessor-based (PID) 4-stage boiler control
- Can provide either outdoor reset and setpoint operation or outdoor reset and DHW operation

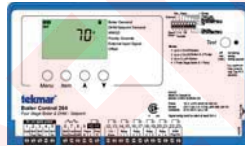

Part #	Mfg #	Description	Price
225036	264	4-Stage Boiler & DHW/Setpoint	752.65

#### 265 Boiler Controls

- Microprocessor-based (PID) boiler control
- Can provide either outdoor reset and setpoint operation or outdoor reset and DHW operation



Part #	Mfg #	Description	Price
236778	265	3-Modulating Boiler & DHW/Setpoint	1191.85

#### 268 Boiler Controls

- Microprocessor-based (PID) 9-stage boiler control
- Can provide either outdoor reset and setpoint operation or outdoor reset and DHW operation

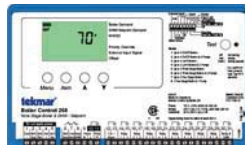

Part #	Mfg #	Description	Price
223413	268	9-Stage Boiler & DHW/Setpoint	1282.97

### 274 Boiler Controls

- Microprocessor-based (PID) outdoor reset control
- This control regulates a single heating water temperature through Outdoor Temperature Reset and/or setpoint/DHW target control. It is capable of controlling (stage and rotate) up to 4 on/off boilers as well as the system pump (pump sequencing option).
- Replacing model #262

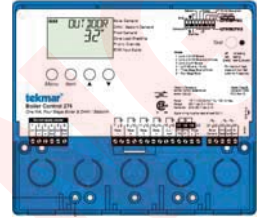

Part #	Mfg #	Description	Price
915394	274	4-Stage Boiler & DHW/Setpoint	770.87

### Sensors



Part #	Mfg #	Description	Price
135299	071	Universal Sensor	26.73

Heating

Check stock, pricing and place orders online at <http://woe.metpipe.com!>



## Boiler Controls



### Switching Relays

#### Taco SR Series Switching Relays



- Taco Switching Relays combine clearly-labeled PC board layouts with advanced features that allow you to completely customize your system.
- External indicator lights give you instant diagnostic feedback, making service calls or new installation start-ups a snap.
- All switching relays are UL listed, use standard "ice cube" replaceable relays and are compatible with conventional and programmable thermostats.
- For larger jobs, switching relays can be expanded up to 20 zones with priority.
- Mix-and-match as needed to customize the system.
- External Indicator Lights
- Switchable Priority
- Simplified Wiring
- Fully Enclosed Snap-Out Relays
- Compact Design
- Fuse Protected
- 100% Factory Tested
- Isolated End Switch
- Universal Thermostat Compatibility
- 24 Volt Power Input or Output Terminal
- Extended 3 Year Warranty
- Made in the USA

Part #	Mfg #	Zones	Voltage	Max Load	Price
191459	SR501-2	1	120V	5 Amps	63.29
228493	SR502-2	2	120V	15 Amps	142.79
163894	SR503-2	3	120V	15 Amps	154.76
909185	SR504-2	4	120V	20 Amps	236.85
787792	SR506-2	6	120V	20 Amps	257.81

### Zone Valve Controls

#### Taco ZVC Series Zone Valve Controls

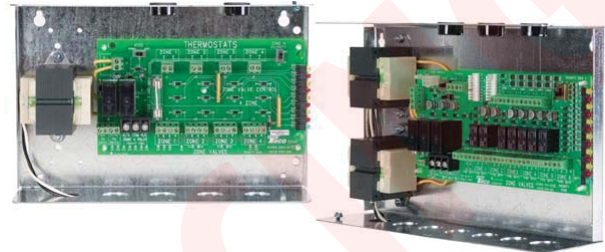

- Fully fuse protected, they also include two isolated end switches and a built-in priority switch.
- The contractor friendly PC board layout eliminates the problems caused by incorrect wiring and the "unfinished" look of conventional zone valve installations.
- The sturdy screw connections add additional reliability, while the external indicator lights provide instant diagnostic feedback, reducing installation time. All Taco Zone Valve Controls are UL and CSA listed and carry an extended 3 year warranty.
- External Indicator Lights
- Switchable Priority
- Simplified Wiring
- Works with 2, 3, or 4-Wire Zone Valves
- Compact Design
- Two Isolated End Switches
- Extra Set of Dry Contacts
- Universal Thermostat Compatibility
- Sturdy Screw Connections
- Made in the USA
- Features Priority zones

Part #	Mfg #	Zones	Transformer Rating	Price
167819	ZVC4042	4 w/Priority	40 VA, 120 VAC	136.59
932968	ZVC4063	6 w/Priority	80 VA, 120 VAC	176.46



## Boiler Controls

### Low Water Cut-Offs

#### 150S Series Mechanical LWCO for Steam Boilers

- For commercial and industrial low or high pressure boiler application
- Maximum pressure: 150 psi
- 120 or 240VAC



Part #	Mfg #	Model #	Description	Price
124634	171802	150S-MD	150S w/Maximum Differential	591.94

#### PS 800 Series Electronic LWCO for Steam Boilers

- For residential and commercial applications
- 15 Seconds delay on make
- 10 Seconds delay on break
- 3500 Ohms probe sensitivity
- Maximum ambient temperature: 120°F
- Maximum steam pressure: 15 psi
- Maximum water temp: 250°F



Part #	Mfg #	Model #	Description	Price
43973	153875	PS-801-120	120V Auto Reset	182.88
118857	153880	PS-801-M-120	120V Manual Reset	206.94
168437	153917	PS802-24	24V Auto Reset	182.88

#### 67 Series Float Type LWCO for Steam Boilers

- For residential and commercial applications
- For boilers of any steaming capacity
- Quick hook-up fittings provided
- Dual precision switches
- Large float chamber
- Maximum steam pressure: 20 psi
- 120 or 240VAC



Part #	Mfg #	Model #	Description	Price
15502	149400	67	Low Water Cut-Off	293.57
15503	149600	67-G	For Millivolt Service	293.57

#### 63 Series Float Type LWCO for Hot Water Boilers and Steam Boilers

- For residential, commercial and industrial applications
- Heavy duty construction
- Includes No. 2 switch
- Maximum boiler pressure: 50 psi



Part #	Mfg #	Model #	Description	Price
15507	142400	63	120 or 240VAC	404.25
15508	143100	63-M	Manual Reset	404.25

#### 42 Series Combination Low Water Cut-Off/Pump Controllers for Steam Boilers

- For residential, commercial and industrial low and medium pressure steam boilers with a separate water column
- For boilers of any steaming capacity
- Monel bellows for corrosion resistance
- Single pole, single throw mercury switches
- Enclosed junction box protects switches
- Maximum pressure: 50 psi



Part #	Mfg #	Model #	Description	Price
890910	129302	42S	120 or 240VAC	529.38

#### 51-S-2 Series Combination Mechanical Water Feeder/Low Water Cut-Offs

- For high capacity (up to 35000 sq ft) low pressure steam & hot water boilers with cold water feed
- Integral strainer
- Maximum water supply pressure: 100 psi
- Maximum pressure: 35 psi



Part #	Mfg #	Model #	Description	Price
15493	135600	51-S	Combination	924.00



## Boiler Controls



### Electronic Low Water Cut-Offs

#### 751 Series Electronic LWCO for Hot Water or Steam Boilers

- For commercial or industrial applications
- Primary or secondary control on hot water boilers
- Secondary control (manual reset models only) on steam boilers
- Manual reset models meet the requirements of ASME Standard CSD-1.
- Green power in on indicating LED
- Red low water indicating LED
- Test button
- No lock out with loss of power if probe is in water
- 20,000 ohms sensitivity



Part #	Mfg #	Model #	Description	Price
225502	176234	751P-MT-120	120V w/probe	192.50

#### RB24 Series Electronic Low Water Cut-Offs

- Brass threads enable a secure and trouble-free installation
- Test button to confirm proper operation
- Universal wiring harness fits 100% of today's gas boilers
- Compact size
- Easy to install and wire
- Automatic reset feature resumes operations after a power outage when water is on probe
- Green LED indicating power is on
- Red LED indicating low water condition
- Solid state operation
- 15,000 ohms probe sensitivity
- Maximum ambient temperature 120°F (49°C)
- Maximum water temperature 250°F (121°C)
- Maximum water pressure of 160 psi (11.2 kg/cm<sup>2</sup>)



Part #	Mfg #	Model #	Description	Price
945083	144690	RB-24E-L	Probe LWCO with burner cntrl harness	111.65

### Water Feeders

#### WFE Series Uni-Match® Electric Water Feeders

- Field-adjustable dwell-feed cycles
- Multi-color LED status indicator
- Manual feed button
- Hard-stop limit to minimize chances of flooding the boiler
- Compatible with all electronic & mechanical Low Water Cut-Offs
- Includes adaptors for connection to 1/2" copper tubing
- Removable strainer (replace after cleaning)
- Maximum water pressure 150 psi (10.5 kg/cm<sup>2</sup>)
- Maximum boiler pressure 15 psi (1 kg/cm<sup>2</sup>)
- Maximum water temperature 120°F (49°C)
- Maximum ambient temperature 100°F (38°C)
- Maximum power consumption (during feed cycle)
- 15 VA @ 24VAC
- 20 VA @ 120 VAC (50 or 60 Hz)



Part #	Mfg #	Model #	Description	Price
925528	169550	WFE-24V	24VAC	264.69
925529	169560	WFE-120V	120VAC	264.69

#### 47 Series Mechanical Water Feeders

- For steam and hot water boilers with cold water feed
- Proportional feed action
- Quick hook-up fittings provided
- Quick-change replaceable cartridge valve and strainer
- Maximum water supply pressure: 150 psi
- Maximum boiler pressure: 25 psi



Part #	Mfg #	Model #	Description	Price
15489	132700	47	120 or 240VAC	611.19

#### 51 Series Mechanical Water Feeders

- For low pressure steam and hot water boilers larger than 5000 sq ft capacity with cold water feed
- Quick-change replaceable cartridge valve and strainer
- Proportional feed action
- Maximum water supply pressure: 150 psi
- Maximum pressure: 35 psi



Part #	Mfg #	Model #	Description	Price
15490	134700	51	120 or 240VAC	779.63



## Boiler Controls

### 247 Series Mechanical Water Feeders

- For steam and hot water boilers with cold water feed
- Quick-change replaceable cartridge valve and strainer
- Proportional feed action
- Quiet, durable operation
- Maximum water supply pressure: 150 psi
- Maximum pressure: 30 psi



Part #	Mfg #	Model #	Description	Price
15496	133700	247	120 or 240VAC	577.50

### 21 Series Make-Up Water Feeders

- For boiler receiver tanks
- Direct mounting eliminates equalizing connections
- Proportional feed action
- Mounting flange: (6) 17/32" bolt holes on a 5-3/4" bolt circle
- Soft seat provides positive seal
- Maximum water supply pressure: 150 psi
- Maximum pressure: 35 psi



Part #	Mfg #	Model #	Description	Price
15487	126400	21	5.75" Bolt Feeder	514.94

### 25-A Series Make-Up Water Feeders

- For boiler receiver tanks
- Proportional feed action
- Soft seat provides positive seal
- Maximum water supply pressure: 100 psi
- Maximum pressure: 35 psi



Part #	Mfg #	Model #	Description	Price
15488	126800	25-A	Float Operated	760.38

## Boiler Control Switches

### No. 2 Switches

- For Series 47, 247, 51, 51-S, 53, 63 & 847 water feeders to add low water cut-off function
- Provides flexibility for selection of functions desired



Part #	Mfg #	Model #	Description	Price
15485	110000	2	Low Water Cut-off Switch	119.35
15486	110100	2-M	No. 2 w/Manual Reset	119.35

## Blow Down Valves

### 14-B Series Full Port Ball Type

- Teflon seats provide bind free, leak tight ball movement
- Easy open handle keeps hands away from hot water and steam
- Gasket and mounting screws included
- Maximum pressure: 30 psi



Part #	Mfg #	Model #	Description	Price
15528	310447	14-B	For 47, 67 & 70	93.00

## Liquid Flow Switches

- Do not use liquid flow switches on systems with flow greater than 10' per second

### FS4-3 Series Liquid Flow Switches

- Universal design serves the widest variety of applications
- For starting or stopping electrically operated equipment
- (2) Electrical knock-outs
- Single pole, double throw snap switch
- Sealed Monel bellows
- (4) Stainless steel paddles included: 1", 2", 3" & 6"
- Minimum temperature (fluid or ambient): 32°F
- Maximum temperature: 300°F
- Maximum pressure: 150 psi



Part #	Mfg #	Model #	Description	Price
15521	114400	FS4-3	1" NPT Connection	127.00

### FS254 Series Liquid Flow Switch

- 1" NPT pipe connection
- Adjustable flow set points
- Brass body
- EPDM O-ring sealed
- Brass paddle arms
- Four Stainless steel paddles included 1", 2", 3" & 6"
- SPDT switch
- NEMA 4 enclosure
- Minimum temperature (fluid or ambient) 32°F (0°C)
- Maximum temperature (fluid) 250°F (121°C)
- Maximum pressure 160 psig (11.2 kg/cm)
- Replaced old model #FS4-3



Part #	Mfg #	Model #	Description	Price
924172	120610	FS254	1" NPT Connection	175.00





## Boiler Controls

### FS1 Series High Sensitivity Liquid Flow Switches

- For general purpose applications where high sensitivity is required and moderate or low flow rates are encountered
- For applications requiring water-tight, dust-tight or NEMA 4X rated flow switch
- Single pole, double throw snap switch
- Minimum temperature (fluid or ambient): 32°F
- Maximum temperature: 225°F
- Maximum operating pressure: 100 psi



Part #	Mfg #	Model #	Description	Price
15520	113200	FS1	1/2" NPT Connection	225.00

### Replacement Parts

#### Gaskets

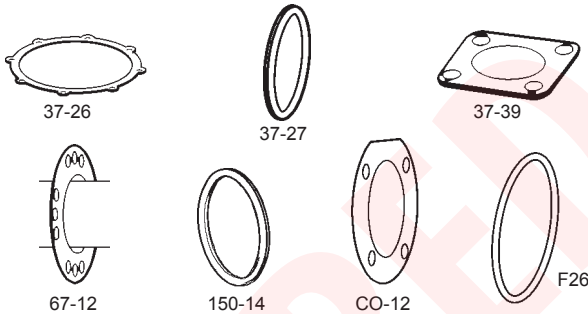

Part #	Mfg #	Model #	Used With	Price
15532	312700	37-26	47	8.15
15533	312800	37-27	47, 51, 53, 3155	4.60
15534	312900	37-28	53, 3155, 21, 25A, 51	4.60
15535	313200	37-39	47, 53, 67, 70	4.60
15536	318800	67-12	61, 64, 67, 70, 80	4.60
15538	325400	150-14	93, 193, 150	6.15
15540	302600	CO-12	42,61,63,64, 65, 42S	6.15
15541	304100	F26	221, 25A, 51, 53, 3155	8.55
15531	311100	21-27	21	4.95
43974	335400	847-26	851-S	5.95

#### Body Gaskets

Part #	Mfg #	Model #	Used With	Price
214307	230-39A	230-39A	230-1, 240-1	5.19



### Head Mechanisms

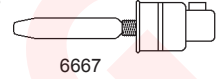

Part #	Mfg #	Model #	Used With	Price
15501	127100	25-A-HD	25A Series	659.32
15499	134900	51-HD	51 Series	700.00
15492	135800	51-S-HD	51-S Series	820.00
15515	153825	6667	61, 67, 69, 70, 767 Series	226.19

### Strainer Basket Assembly

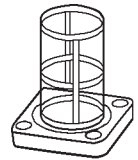

Part #	Mfg #	Model #	Used With	Price
15551	347100	SA101-38	47, 51, 101	43.00
15544	340700	SA37-38	851S	43.00

### Valve & Strainer Assembly Kits



Part #	Mfg #	Model #	Used With	Price
15546	341600	SA47-101-102	47, 247, 847	270.00
15549	342500	SA51-101-102	51, 851	270.00



### Headers

#### Hydronic Heating Headers



- Tested to 100 PSI
- Can be used with zone valves or pumps
- For hot water heating systems
- Less chance of leaks
- Allows ability to add a future zone off end of header
- All zones line up perfectly every time
- ASTM A53 Schedule 40

Part #	Mfg #	Zones	Size	Price
134373	H-3	3 Zone	1-1/4" x 3/4"	25.78
134374	H-4	4 Zone	1-1/4" x 3/4"	33.00



## Boiler Feed Units

### HBF™ Series Boiler Feed Units

- Returns condensate to the boiler
- Steel received with HoffGuard™ corrosion resistant coating
- Low height NPT inlet for easy return line piping
- NPT Connections for drain and secondary vent
- Float operated internal water make-up water feeder
- Includes water level gauge with protective brass rods and shut-off valves
- Pump seal maximum temperature: 250°F
- Pump maximum temperature: 210°F
- Open drip-proof motors only 115/230-1-60



#### Simplex Pumps

Part #	Mfg #	Model	Sq Ft EDR	Boiler	Price
124679	161051	50HBFS	7,000	50 hp	2592.50
112946	161053	100HBFS	13,800	100 hp	3618.52

### Boiler Make-Up Valve



- Float operated make up water valve for many Hoffman boiler feeds.
- 2-1/2 inch NPT
- Maximum inlet pressure 30 PSI.

Part #	Mfg #	Description	Price
41161	DL1634	Roberts Boiler Make-Up Valve	350.00

### Watchman® Condensate Pumps

- Low height NPT inlet
- Separate NPT connections for secondary vent
- NPT Drain connections



#### Watchman® WC® Series Simplex Condensate Units

- Cast iron receiver
- 1/3 hp Motor
- 20-Year warranty against corrosion

Part #	Mfg #	Model	Pump Cap	Receiver Cap	Price
41163	160029	WC6-20B	9 gpm	6 gal	1555.50
43835	160031	WC12-20B	18 gpm	14 gal	2060.49

### Watchman® Replacement Parts

Part #	Mfg #	Description	Price
36628	180001	1/3 HP Pump & Motor Assy for Watchman series	1155.00
39763	180013	Mechanical Seal Kit for A & B Units	94.00

### Parts

Part #	Mfg #	Description	Price
44250	DG0060	Gasket	2.55
36629	DA0393	Float Switch	285.00

### Dura-Stat® Replacement Module

- To upgrade thermostatic steam traps
- Stainless steel
- Durable and water hammer resistant
- Hoffman Specialties service pkg

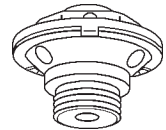

Part #	Mfg #	Size	Use With	Price
15432	600084	1/2" NPT	17C	52.87

### Float & Thermostatic 55' Cover Assembly

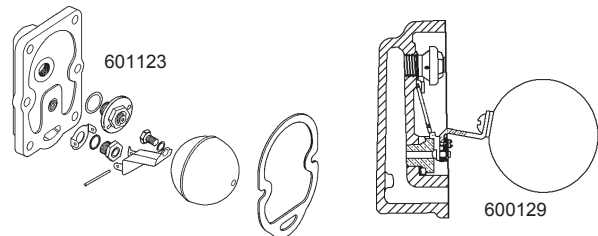

Part #	Mfg #	Size	PSI	Price
15425	600129	3/4"	15 psi	201.69
15426	601114	1"	15 psi	213.24
15427	601117	1-1/4"	15 psi	293.20
15428	601120	1-1/2"	15 psi	422.02
15429	601123	2"	15 psi	710.77

### 8C & 9C Service Packages

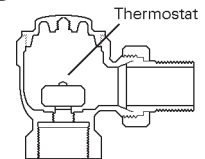

Part #	Mfg #	Description	Price
50493	600205	Thermostat Service Pack	69.30



## Steam Traps

### Steam Traps

#### Inverted Bucket for Horizontal Installation - Cast Iron

- Stainless steel internal check valve
- For pressures to 250 psig capacities to 4,400 lb/hr
- Thermal vent bucket
- Stainless steel pop drain
- Probe connection
- Thermo drain
- Scrub wire
- Connections: screwed NPT and screwed BSPT



#### 800 Series (with Integral Strainer)

- Maximum operating pressure: 150 psig
- Cannot be furnished with both thermic vent bucket and check valve

Part #	Mfg #	Pipe Conn	Pressure	Price
124288	800	1/2"	20 psi	137.00
145444	800	1/2"	80 psi	142.00
139721	800	1/2"	125 psi	142.00
124314	800	3/4"	20 psi	142.00
224668	800	3/4"	80 psi	142.00
787938	800	3/4"	125 psi	142.00
179518	800	3/4"	150 psi	142.00

#### 811 Series

- Maximum operating pressure: 250 psig

Part #	Mfg #	Pipe Conn	Pressure	Price
168897	811	3/4"	15 psi	188.00
47206	811	3/4"	30 psi	188.00
50576	811	3/4"	70 psi	188.00
118132	811	3/4"	125 psi	188.00
178467	811	3/4"	250 psi	188.00
141379	811	1"	15 psi	188.00
152153	811	1"	125 psi	188.00

#### 814 Series

- Maximum operating pressure: 250 psig



Part #	Mfg #	Pipe Conn	Pressure	Price
191752	814	1-1/4"	15 psi	732.00
787906	814	1-1/4"	125 psi	732.00

#### 1800 Series - Inverted Bucket for Horizontal Installation - Stainless Steel

- Stainless steel pop drain for Models 1811/1822
- For pressures to 650 psig capacities to 2,380 lb/hr
- Insu-Pak™ insulation
- Bucket vent wire
- Probe connection
- Connections:
  - Screwed NPT
  - Screwed BSPT
  - Socket weld
  - Flanged (consult factory)



Part #	Mfg #	Pipe Conn	Pressure	Price
166796	1811	3/4"	15 psi	299.00
203230	1811	3/4"	70 psi	299.00
221422	1811	3/4"	125 psi	299.00
203231	1811	3/4"	200 psi	299.00

#### CD-33 Series - Thermodynamic Disc Steam Traps for Horizontal Installation - Stainless Steel

- For steam service up to 600 psig capacities to 2,500 lb/hr
- (3) Discharge port design
- Minimum wear with controlled cycling
- Freeze-resistant
- Hardened seat and disc
- S Suffix = With integral strainer

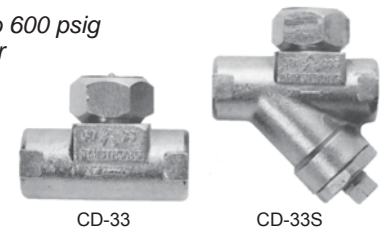

Part #	Mfg #	Pipe Conn	Price
194952	CD-33	1/2"	179.31
194954	CD-33	3/4"	200.12
194955	CD-33	1"	320.19
180395	CD-33S	3/4"	248.95



# Steam Traps

## Float and Thermostatic Steam Traps for Horizontal Installation with Thermostatic Air Vent - Cast Iron

- For pressures from vacuum to 30 psig capacities to 8,900 lb/hr
- Connections: screwed NPT and screwed BSPT

- Standard connection

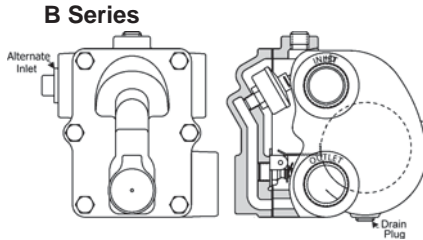

Part #	Mfg #	Pipe Conn	Pressure	Price
119029	15B-3	3/4"	15 psi	156.37
176175	15B-4	1"	15 psi	188.36
157086	15B-5	1-1/4"	15 psi	228.34
115590	15B-6	1-1/2"	15 psi	332.29
235591	15B-8	2"	15 psi	611.27
119409	30B-3	3/4"	30 psi	183.92

- In-line connection

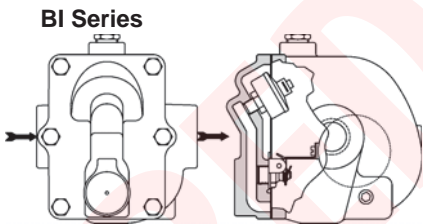

Part #	Mfg #	Pipe Conn	Pressure	Price
199268	15BI-3	3/4"	15 psi	156.37
887159	15BI-4	1"	15 psi	188.36

## A Series - Float and Thermostatic Steam Traps for Horizontal Installation with Thermostatic Air Vent - Cast Iron

- For pressures to 175 psig capacities to 8,600 lb/hr
- Standard connection
- Optional integral vacuum breaker: add VB as suffix
- Connections: screwed NPT and screwed BSPT

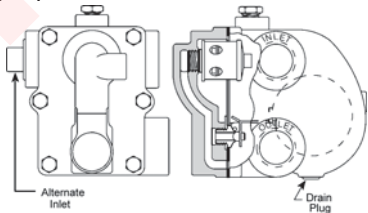

Part #	Mfg #	Pipe Conn	Pressure	Price
216022	125A-3	3/4"	125 psi	300.00
804218	125A-4	1"	125 psi	334.00

## Parts Body Gaskets

Part #	Mfg #	Description	Price
190057	A21348	For B3 F&T Steam Trap	6.80
822367	A21446	For 312 Inverted Bucket Steam Trap, 21-312 & 32-LD Liquid Drainer, 32-AV Air Vent & 370 Series Purger	7.30
36333	A21825	For 800, 811, 880 & 881 Inverted Bucket Steam Trap	5.80
181307	A22181	For 812, 882 & 82-DC Inverted Bucket Steam Trap	6.10
213174	A22182	For 813, 883, 983 & 83-DC Inverted Bucket Steam Trap	8.70
236680	A22284	For 213, 313, 413, Inverted Bucket Steam Trap; 3-AV & 33-AV Air Vent; 2313HLS, 2413HLS, 3-LD & 33-LD Liquid Drainer	7.40

## Vendor Managed Inventory Program

Metropolitan Pipe can assist you in setting up your own **stockroom**- complete with barcodes for easy tracking.



Product ID: 454645

Kohler 4330-0 Kingston elongated wall-hung bowl with top spud



Aisle 7 - Shelf B



# Steam Traps



## Steam Traps - Pressure Change & Repair Kits

### PCA Repair Kits

- The bucket trap's Valve Mechanism (often referred to as a PCA — Pressure Change Assembly) is the bucket trap component subject to the most wear and tear. The mechanism is opening and closing against the trap's discharge seat hundreds of times a day. You should replace the valve mechanism every three to six years.
- You may change the pressure differential in an existing trap by changing the PCA.



Part #	Mfg #	Description	Price
179933	A23239	#38 For 800, 880, 211, 811, 881, 310 & 981	82.00
191621	B1669-1	1/4" For 211, 811, 881, 981, & 310	82.00
118883	B1669-2	3/16" For 800, 880, 211, 811, 881, 981 & 310	82.00
224311	B1669-3	5/32" For 211, 811, 881, 981 & 310	82.00
144039	B1669-4	1/8" For 800, 880, 211, 811, 881, 981 & 310	82.00
229189	B1669-5	7/64" For 800, 880, 211, 811, 881, 981 & 310	82.00
229213	B1670-1	5/16" For 212, 812, & 882	153.00
164129	B1671-6	7/32" For 213, 813, 883, 312, 313 & 983	198.00
139788	B1671-7	3/16" For 213, 813, 883, 312, 313 & 983	198.00

Heating

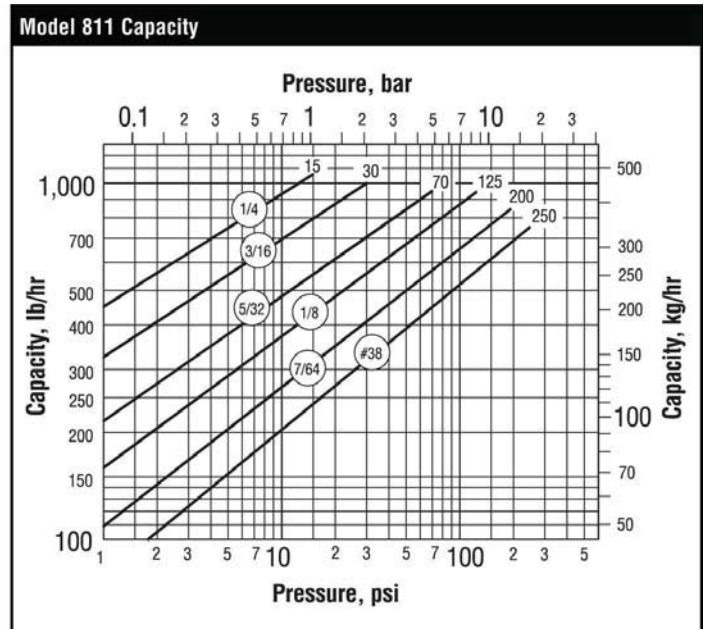
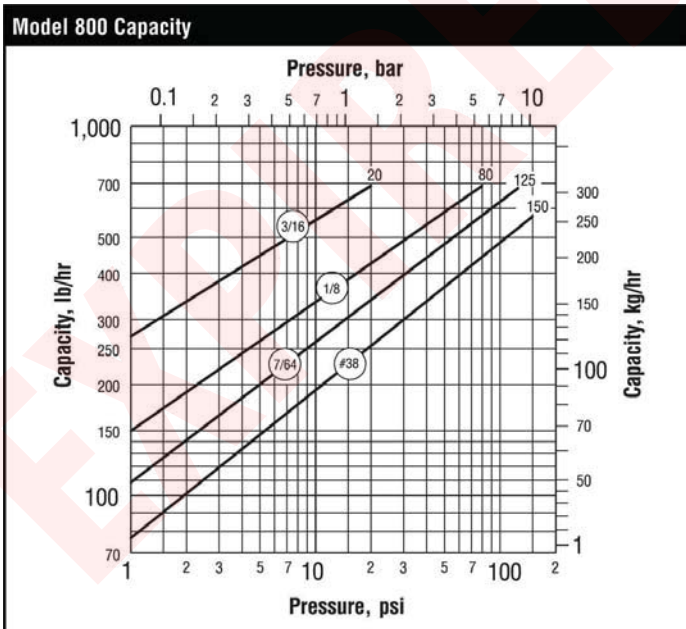

Prices & specifications are subject to change.

You can check stock availability, pricing and place orders online at [www.MetPipe.com](http://www.MetPipe.com).



# Steam Traps

## Thermostatic Steam Traps

### Steam Traps for Low & Moderate Pressure Service

- For all models VAC 25 psig; VAC 65 psig
- Heavy-duty cast bronze or forged brass body
- Forged brass cover, union nut and tailpiece
- Corrosion-resistant seat and plug with stainless steel option
- Working parts factory calibrated within the cage unit
- 100% Factory tested under live steam and condensate



Part #	Mfg #	Pipe Size	Type	Price
15069	12A	1/2" x 3/4"	Angle	87.82
15070	122A	1/2"	Angle	54.94
15071	122S	1/2"	Straight	77.52
15073	134A	3/4"	Angle	92.31
15074	134S	3/4"	Straight	100.19

### Steam Trap Repair Elements (Cage Units)

- For all makes and models VAC to 300 psig
- 1-Piece repair
- Factory tested under live steam
- Diaphragm type, 25 psig

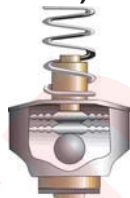

Part #	Mfg #	For Models	Price
15044	1721	Barnes & Jones 12, 12C, 12, 122A, 122S, 122G, 1253 & 3045	39.59
15047	1764	Warren & Webster 712, 712HB, 712GS, 712T, 723A, 764A, & 12H7	39.59
15049	1929	Barnes & Jones 123, 124, 134A & 134S	39.59
15052	1950	Durham-Bush 1, 1A, 1B, 1C, 1D, 1E, V1A, V1B, V1R, 1A, 16, 1EVS1FT8, 20-5, 23-E, 30-1, 30-1A, 30-2, 30-2A, 30-3, 30-4 & 30-5	39.59
15054	1955	Barnes & Jones 3FT, 4FT, 5FT, 63FT, 64FT & 65FT	39.59
15056	1972	Warren & Webster 03HT, 702, 703, 713A726A, 764A, 902A, 902V-1, 903H1, 903HT, 913H, 913A and Series 02 and 502	39.59
56587	1998	Warren & Webster 512, 512HB & 513	38.82
15065	3500	Hoffman 17C, 17D & 17K,	39.59
45341	4177	4117 Cage Unit	37.82

## In-Line Float & Thermostatic Steam Traps

### Series 2000 (VAC-30 psig)

- Variety of hook-up combinations
- Unaffected by sudden or wide pressure changes
- Responds quickly to condensate load changes
- Continuous discharge
- Condensate discharge temperature closely follows the saturated steam curve
- Energy efficient, simple construction, on-line repair



Part #	Mfg #	Pipe Size	Price
15086	FT2015-3	3/4"	140.06
15088	FT2015-4	1"	158.80
15090	FT2015-5	1-1/4"	245.87
15092	FT2015-6	1-1/2"	322.71
15093	FT2015-8	2"	579.29

### Repair Kits for 2000 Series Traps

Part #	Mfg #	Fits Trap	Pipe Size	Price
15076	RK2015-3	FT2015-3	3/4"	111.39
15078	RK2015-4	FT2015-4	1"	124.28
15080	RK2015-5	FT2015-5	1-1/4"	196.06
15082	RK2015-6	FT2015-6	1-1/2"	266.55
15084	RK2015-8	FT2015-8	2"	490.36

## Series 40 "Old Style" Float & Thermostatic Traps

- Heavy duty semi steel body
- Stainless steel valve plug
- Stainless steel seat
- Corrosion resistant float
- One piece thermostatic "Cage Unit"
- Water sealed, float operated valve for immediate discharge of condensate
- All parts easily accessible with trap online



Part #	Mfg #	Sarco #	Pipe Size	Price
15085	41T	1FT	3/4"	211.26
15087	42T	2FT	1"	221.28
15089	43T	3FT	1-1/4"	360.31
15091	44T	4FT	1-1/2"	426.17

### Repair Kits for Series 40 Traps

Part #	Mfg #	Fits Trap	Pipe Size	Price
15075	1FT	41T	3/4"	116.59
15077	2FT	42T	1"	133.37
15079	3FT	43T	1-1/4"	183.13
15081	4FT	44T	1-1/2"	203.04
15083	5FT	457T	2"	406.09

Heating



## Steam Traps

### Float & Thermostatic Steam Trap Repair Kits

- For all common F and T models
- Stainless steel valve plug
- Brass or stainless steel seat
- 1-Piece cage unit
- Water sealed, float operated valve
- Stainless steel, corrosion-resistant float



### Sarco Repair Kits

Part #	Mfg #	Description		Price
39692	FT15	FT-15	3/4"	112.70
39695	FT15-1	FT-15	1"	112.70
41231	FT15-2	FT-15	1-1/4"	174.74
41235	FT15-3	FT-15	1-1/2"	253.29
39696	FT15-4	FT-15	2"	391.95

### Tools

Part #	Mfg #	Description	Price
227594	3892	Cover Wrench	21.71



### Float & Thermostatic Steam Traps

#### H Series BearTrap®

- Universal 4-port tappings, (2 inlets, 2 outlets) that provide versatility
- Stainless steel internal components
- Resistant to water hammer and corrosion
- Below condensate level seat design prevents steam leakage
- Maximum operating pressure: 175 psig
- Maximum body design pressure:  
250 psig (3/4" - 1-1/4")  
175 psig (1-1/2" - 2")
- Maximum temperature:  
406°F (3/4" - 1-1/4")  
377°F (1-1/2" - 2")



Part #	Mfg #	Model	Size	PSI	Price
47787	404200	FT015H	3/4"	15 psi	210.00
47214	404210	FT015H	1"	15 psi	245.00
47789	404220	FT015H	1-1/4"	15 psi	315.00
47791	401626	FT015H	1-1/2"	15 psi	495.00
47792	401629	FT015H	2"	15 psi	815.00

### Cover Assembly

- Includes cover casting, all internal components and cover gasket

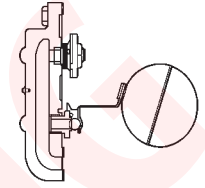

Part #	Mfg #	Size	Fits Traps	Price
118510	604001	3/4" & 1"	FT015H	165.26
15425	600129	3/4"	55	201.69
15426	601114	1"	55	213.24
123924	604006	1-1/4"	FT015H	205.24
15427	601117	1-1/4"	55	293.20
15428	601120	1-1/2"	55 & FT015H	422.02
15429	601123	2"	55 & FT015H	710.77

### 17C Series Balanced Pressure BearTrap®

- For institutional, commercial, and residential heating system applications where low or moderate water hammer may occur
- Sub cooling
- Replaceable Dura-Stat® module
- Stainless steel components
- Resistant to moderate water hammer and chemical attack
- Maximum operating pressure: 25 psig
- 3-Year warranty



Angle w/Short Nipple



Swivel



Vertical

Part #	Mfg #	Size	Description	Price
15394	401536	1/2" MNPT	Angle	76.00
15396	401551	1/2" MNPT	Vertical	89.74
15395	401545	1/2" MNPT	Swivel	106.00



# Vents

## Air/Gas Vents

### 1-AV Series - Free Floating Lever - Cast Iron

- For pressures to 300 psig or specific gravity > 0.80
- Positive-closing, free-floating lever for leak tight closing



Part #	Mfg #	Pipe Conn	Price
45051	1-AV	1/2"	150.00
171831	1-AV	3/4"	150.00



## Vent-Rite Convector & Riser Air Valves

- Straight vent
- Balances the steam radiation by controlling venting on convector & risers

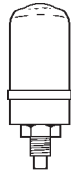

Part #	Mfg #	Connection	Vent Port	PSI	Price
15042	31	1/8" M	1/16"	6 psi	26.00

## Dole Flow Regulators

### Air Valves

- For 1-pipe systems
- Adjustable angle vari-vent



Part #	Mfg #	Size	Price
15166	1A	1/8"	30.01

### Air Vents



Part #	Mfg #	Description	Price
15174	1701202	1/8" Vent	2.88
15176	1701208	Key for Air Vents	0.41
14982	417-3	1/8" Coin Air Vent	7.76

## Dole Vents



#15180      #15178      #15181      #909447

Part #	Mfg #	Description	Price
15180	1933	1/8" Male Angle Vent	33.21
15178	1933	1/8" Male Straight SS Vent	55.86
15181	1933	3/4" Male x 1/2" Female Straight SS Vent	50.91
909477	90-1	3/4" x 1/2" Straight SS Vent	39.39

## HEAT-TIMER®

### VariValve® Radiator Air Vents

- Provides a means for air to be driven out of the radiator as steam enters, allowing main lines to fill quicker
- Fingertip lever allows adjustment of venting rate
- Phosphor bronze bellows insures positive shutoff
- Quiet operation, no clicking or hissing
- 1/8" Pipe thread



Part #	Mfg #	Configuration	Price
15342	925005-00	90° Angle	25.42
15341	925006-00	Straight	25.42

## Hoffman SPECIALTY

### Vacuum Breakers

- For use on closed vessels & piping systems to control induced vacuum within safe limits
- Adjustable from 1/4" - 20" Hg vacuum
- Maximum operating temperature: 366°F
- Maximum operating pressure: 150 psig
- Adjustable temperature range: 100° to 140°F



#### Model 62

Part #	Mfg #	Description	Price
15402	62	3/4" MNPT Shank	92.00

Heating





# Vents

## Special Steam Vents

### Model 74 Steam Unit Heater Air Valve - Straight Shank

- Float-type thermostatic vent & single non-adjustable port
- Install 6-10" above horizontal return and 18" above the boiler water line
- Maximum operating pressure: 35 psig
- Maximum pressure: 25 psig



Part #	Mfg #	Size	Price
15403	74	1/2" FNPT x 3/4" MNPT	110.17

## Main Steam Vents

### Model 75 Air Valve (Non-Vacuum) - Straight Shank

- For medium & large systems
- Float-type thermostatic vent & single non-adjustable port
- Maximum operating pressure: 3 psig
- Maximum pressure: 15 psig



Part #	Mfg #	Size	Price
15404	75	1/2" FNPT x 3/4" MNPT	113.00

## Water Main Vents

### Model 78 Water Main Vent Valve - Straight Shank

- For use on high pressure hot or cold water or glycol mains & process applications with specific gravity > 0.7
- Cast brass body & built-in check valve
- Tapped at top for 1/8" NPT safety drain connection
- Maximum operating pressure: 150 psig
- Maximum hydrostatic pressure: 450 psig
- Maximum temperature: 250°F



Part #	Mfg #	Size	Price
15405	78	3/4" NPT	159.93

### Model 79 Water Main Vent Valve - Straight Shank

- For use on hot or cold or glycol water mains and process applications with specific gravity > 0.7
- Tapped at top for 1/8" NPT safety drain connection
- Removable top & built-in check valve
- Maximum operating pressure: 75 psig
- Maximum hydrostatic pressure: 200 psig
- Maximum temperature: 250°F



Part #	Mfg #	Size	Price
15406	79	1/2" FNPT x 3/4" MNPT	102.18



## Hydronic Valves

### Automatic Air Vents

- Brass body with non-ferrous internals
- Maximum operating temperature: 240°F
- Maximum operating pressure: 150 psi



Part #	Mfg #	Model #	Connection	Price
43757	113021	#87	1/2" FPT/3/4" MPT	63.89



## Automatic Air Valves

### No. 7 Auto-Vent®

- Continuous venting of hot water heating systems & chilled water cooling systems
- For installation on mains, pipe lines, unit heaters, chillers, convectors, radiant panels and coils
- Vertical mounting



Part #	Mfg #	Size	PSI	Price
15480	#7	1/8" FIP	75	26.99

### No. 67 Auto-Vent®

- Continuous venting of hot water heating systems & chilled water cooling systems
- For installation on convector radiators, baseboard radiation and radiant panels
- Float operated & vertical mounting



Part #	Mfg #	Size	PSI	Price
15481	#67	1/8" MIP	50	7.12



## SPIROTOP®

### Brass Quick Air Releasers

- 20-Year limited warranty
- Continuous air venting & reliable vacuum breaker for system draining
- Standard working pressure: 150 psig
- Maximum operating temperature: 270°F



Part #	Mfg #	Size	Price
56640	VTP-050FT	1/2" FNPT	52.38

Heating

Prices & specifications are subject to change.

Our state of the art pipe shop offers cutting, threading, grooving and make-ons up to 36in!



# Air Vents



## SPIROVENT® JUNIOR

### Brass Air Eliminators

- 20-Year limited warranty
- With 1/2" tank-mount
- Maximum working pressure: 150 psig
- Maximum operating temperature: 270°F



#### Threaded

Part #	Mfg #	Size	Rec Flow	Price
41493	VJR-075FT	3/4" FNPT*	6 gpm	100.24
34023	VJR-100TM	1" FNPT	10 gpm	112.88
34024	VJR-125TM	1-1/4" FNPT	15 gpm	156.22
34025	VJR-150TM	1-1/2" FNPT	30 gpm	203.18

#### Sweat

Part #	Mfg #	Size	Rec Flow	Price
935211	VJS-100-TM	1" FNPT	10 gpm	112.88
935210	VJS-125-TM	1-1/4" FNPT	15 gpm	156.22

## SPIROVENT® SENIOR

### Steel Air Eliminators

- 20-Year limited warranty
- Maximum working pressure: 150 psig
- Maximum operating temperature: 270°F



Part #	Mfg #	Size	Rec Flow	Price
51156	VSR-200MT	2" MNPT	45 gpm	254.65



## Ventrite - Air Valves for Steam Systems

### Non-Vacuum Vents

#### Free-Standing Radiator Air Valves

- Angle vent
- Vent 1 is adjustable
- Balances the steam radiation by controlling venting on free-standing radiators

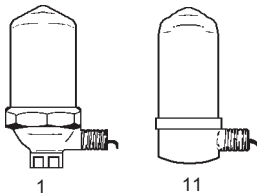

Part #	Mfg #	Connection	Vent Port	Operating Pressure	Price
15040	1	1/8" M	3/32"	3 psi	26.95

## Ventrite - Air Valves for Steam Systems (Continued)

### Free-Standing Radiator Air Valves

Part #	Mfg #	Connection	Vent Port	Operating Pressure	Price
15041	11	1/8" M	1/16"	6 psi	15.21

### Convactor & Riser Air Valves

- Straight vent
- Balances the steam radiation by controlling venting on convactor & risers



Part #	Mfg #	Connection	Vent Port	Operating Pressure	Price
15042	31	1/8" M	1/16"	6 psi	26.00

### Main Vent Air Valves

- Balances the steam radiation by controlling venting on main vents

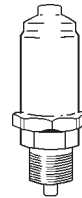

Part #	Mfg #	Connection	Vent Port	Operating Pressure	Price
41040	75	3/4" M x 1/2" F	3/32"	5 psi	62.34



## Automatic Air Vents

- Purge unwanted air from any hydronic installation

### Hy-Vent®

- Place on boiler or at high points throughout the system
- High capacity float-style vents
- Brass body, nickel plated vents
- No bubble breaker
- Maximum pressure: 150 psi
- Maximum temperature: 240°F



Part #	Mfg #	Connection	Max Venting	Price
36780	418	1/2" x 3/4" NPT	50 psi	44.99



## Vents



### Taco 417 Coin Vent

- Installed on water or steam radiators the Taco automatic coin vent is the ideal air purging device. The coin vent features special hygroscopic cellulose discs in the valve body. When dry the discs allow air to be released from the system. Once all the air is purged the discs would then come in contact with system water, where upon they would swell to create a positive shut-off. This continuous cycle prevents the radiators from becoming air bound and speeds the process of filling the system. The vent can also be manually shut-off by means of an internal ball check. The 417 coin vent is suitable for use in water and low pressure steam applications.
- Material: Brass
- Mount: Straight
- Non-Adjustable
- Temperature Range (F): 140°-240°F



Part #	Mfg #	Connection	Max Venting	Price
14982	417-3	1/8"	150 psi	7.76



### Radiator Coin Key Air Valve



Part #	Mfg #	Description	Price
15174	R20-003	Valve Only	2.88

## Electronic Billing

Save time and get your invoices faster online, by email or fax!

Sign up today:  
<http://ebilling.metpipe.com>

Heating



# Oil Tanks

## Residential Oil Tanks

- Steel ASTM A-569
- Female threaded openings
- Pressure tested at 5 to 7 psig
- Operation at atmospheric pressure only
- External finish: black or grey electrostatic powder paint
- External surface: washed & phosphated



### UL-80 Standard Vertical Tanks

Part #	Mfg #	Capacity	Dimensions	Price
15369	204201	275 gal	44" x 27" x 60"	492.80
15370	205201	330 gal	47" x 27" x 72"	510.40



## Steel Tank Flanges

- UL & ASME Boiler and pressure code section II, IV & VII compliant
- ASTM A105/ASME SA105
- ASTM A181-70/ASME SA 181-70

### Standard Flat-Type

- 100 Series - tapped from the hub side

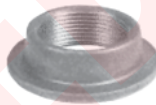

Part #	Mfg #	Size	Price
197041	103	1/2"	4.14
197042	104	3/4"	3.81
204432	105	1"	4.21
204433	106	1-1/4"	5.83
197043	107	1-1/2"	5.43
209788	108	2"	6.19
221598	109	2-1/2"	18.14
214167	110	3"	23.31

### Extra-Heavy Flat-Type

- 175 Series



Part #	Mfg #	Size	Price
31270	175	1/2"	2.75
31271	176	3/4"	3.00
31272	177	1"	3.38
31273	178	1-1/4"	4.01
31274	179	1-1/2"	4.26
31275	180	2"	5.29

## Standard Flat-Type with Pilot

- 250 Series with new forging technology



Part #	Mfg #	Size	Price
31257	250	1/8"	1.89
31258	251	1/4"	1.94
31259	252	3/8"	1.96
31260	253	1/2"	2.07
31261	254	3/4"	2.25
31262	255	1"	2.68
31263	256	1-1/4"	3.18
31264	257	1-1/2"	3.56
31265	258	2"	4.19
31266	259	2-1/2"	7.14
31267	260	3"	8.49
31268	261	3-1/2"	10.17
31269	262	4"	11.66



## SpeedFiLL® Caps & Connectors

- Rust-proof zinc castings
- 100% Interchangeable with Industry Standard Oil Fill-Pipe Nozzle Adapters
- Economical
- Part No. on each Casting for easier re-ordering



3212 3312 3412 3100

### SpeedFiLL® Straight Connectors

Part #	Mfg #	Size	Price
145199	3212	1-1/4" Female	7.94
39839	3312	1-1/4" Male	7.05

### SpeedFiLL® 45° Connectors

Part #	Mfg #	Size	Price
940798	3412	1-1/4" Female	10.47

### SpeedFiLL® Caps

Part #	Mfg #	Description	Price
15372	3100	Universal Cap	4.82

Heating



## Vent Accessories



### Fire Safety Valves

- *Fusible Fire Safety Valves are designed to reduce fire damage by shutting off the flow of oil from the oil tank in the event of a fire. These valves conform to UL/ULC 842 and are listed in the US and Canada. They are required by code in residential oil heating installations in conformance with NFPA 31.*
- *All valves are embossed with the direction of oil flow and include unique part number identification ring or each valve. The seal stem uses a double seal washer/ o-ring system with high grade Viton® equivalent materials suitable for No. 2 fuel oil, Kerosene and up to 20% Biodiesel blend.*

#### Fusible Inline Valves

- *Ideal for use when Fusible Tank Valve cannot l*
- *Heavy duty high quality Brass design*



Part #	Mfg #	Size	Price
15352	2110	3/8" FNPT	18.69
39689	2130	1/2" FNPT	45.15

#### Fusible Burner (Angle) Valves

- *Used at Burner as secondary protection*
- *Heavy duty high quality Brass design*
- *1/4" NPT to burner*
- *Three lengths available to handle any installation situation*



Part #	Mfg #	Size	Price
39665	2230	3/8" Flare, 1-1/4" Long	19.74
34029	2270	3/8" Flare, 2" Long	25.41

#### Fusible Tank Valves

- *Can be fastened directly to bottom or end of most residential tanks*
- *Heavy duty Bronze casting*
- *Male nibble included*
- *Sludge bypass versions available*



Part #	Mfg #	Size	Price
237914	2340	1/2" MNPT In x 3/8" MNPT (Nipple) Out	37.17

#### Check Valves

- *Used to prevent "back-flow" in fuel oil lines*
- *UL/ULC listed design*
- *Uses Viton® equivalent seal*



Part #	Mfg #	Size	Price
15354	2410	3/8" FNPT	18.27

### Fire Safety Valves (Continued)

#### Check Valves

Part #	Mfg #	Size	Price
51233	2430	1/2" FNPT	37.17

#### Vent Caps

- *Available in threaded and slip-on designs*
- *Slip-On design solves clearance problems*
- *Rust-resistant zinc-plated cast iron, as-well-as rust-proof aluminum and Zinc castings*
- *Available sizes from 3/4" to 4"*
- *Each cap includes a screen to prevent debris from entering the vent pipe*

#### Mushroom Vent Caps



- *This popular style is used in the majority of installations in the United States, Alaska, and Canada*
- *Rust-resistant zinc-plated cast iron design is available in female NPT sizes from 3/4" to 4"*
- *Each cap is designed with a 30 mesh screen, to prevent debris from entering the vent pipe*

Part #	Mfg #	Size	Price
44018	4021	3/4" FNPT	6.20
114578	4022	1" FNPT	8.00
114579	4023	1-1/4" FNPT	9.20
44020	4024	1-1/2" FNPT	11.13
114582	4025	2" FNPT	16.36

#### Slip-on Vent Caps

- *Zinc-plated steel with screen*
- *Lightweight and economical*



Part #	Mfg #	Size	Price
15371	4037	1-1/4"	2.43

Prices & specifications are subject to change.

Metropolitan Pipe offers Vendor Managed Inventory - never run out of that part again!



## Vent Accessories

### Alarms & Gauges

#### KING® Combination Fill Alarm & Gauge

- Float is impervious to petroleum products
- Tangle-Free "Solid Link" hinge withstands rough handling
- Durable cast iron with corrosion-resistant powder coating
- New whistle is 5-10 db louder than competitive models (U.S. Patent No. 7,497,185)
- Large, easy-to-read, plastic vial includes UV inhibitors, and is the most break resistant on the market
- Two rubber gaskets enable the gauge to meet up to 5 psi air test requirement
- Double seal with exterior O-ring
- Raised pipe wrench grips
- Fits Vertical Tanks with 42-44" Dia



#4530  
Pictured

Part #	Mfg #	Color	Bottom MNPT	Top FNPT	Price
43095	4523	Red	2"	1-1/4"	38.14

#### KING® Leakproof Tank Gauges

- Molded Float is impervious to petroleum products
- Tangle-Free "Solid Link" hinge withstands rough handling
- Large, easy-to-read, plastic vial includes UV inhibitors, and is the most break resistant on the market
- A new flanged vial provides double seal including exterior O-ring
- Rustproof zinc bushing
- Float assembly can be removed without removal of zinc tank bushing; allowing insertion of measuring stick
- Fits vertical tanks with 42-44" Dia



Part #	Mfg #	Size	Price
166657	4504	1-1/2" & 2"	26.92

### Oil Filters

#### Westwood F84 High Capacity Cast Iron Top Fuel Filter - Epoxy Coated

- Exact Replacement for popular CAST IRON top filters!
- Heavy gage canister with EPOXY COATING on the inside.
- UL GPH and pressure ratings EXCEED comparable OEM filters
- 360 screwdriver slot makes disassembly for element changing easy



Part #	Mfg #	GPH	PSI	Element Type	Price
945387	F84	30	52	CLASSIC YARN™	29.84

#### Replacement Filter Cartridges

Part #	Mfg #	Description	Price
945961	F84-36	CLASSIC YARN™ with Replacement Gasket - For F84	2.99

#### Westwood F100-10 Residential Spin-on Filter

- Residential - 17 GPH, 40 PSI
- 3/8" NPT pipe connection
- 1/8" NPT bleeder/gauge port
- Ultra-10™ 10 micron filter media
- Boxed with o-ring
- Bio-fuel compatible



Part #	Mfg #	Description	Price
51897	F100-10	10 Micron Spin-on Filter	6.48



### Thermal Switches

- UL Listed



Part #	Mfg #	Description	Price
34030	TS-150-B	For 3" & 4" Round Junction Box, Red	10.74



## Vent Accessories

### Gas Combustion Air Systems

#### Fan in a Can

- For 24V gas appliances
- Designed for use when direct connection is not possible or for multiple appliances
- Designed for optimum safety & includes a proving device that won't allow the burner to engage without incoming air flow



Part #	Mfg #	Includes	Price
117467	CAS-4	4" Intake Air Hood, Fan-In-a-Can Assy, 6" - 4" Reducer, Restrictor Plate	385.47



### Hydronic Products Gas Vent Warning Sign



- Yellow gas notification sign

Part #	Mfg #	Description	Price
863900	SGN1	Plastic Direct Vent Sign	13.65



### Flexible Aluminum Duct



Part #	Mfg #	Description	Price
111389	302	4" - 8' Compressed	13.62
113552	334	4" - 25' Compressed	33.02

### Flexible Dryer Kits

- Includes:
  - Aluminum flex duct
  - Vent hood
  - (2) Clamps



Part #	Mfg #	Description	Price
92809	349	4" x 8' Duct, All Aluminum Hood	16.75

### Vent Parts



Vent Hood

Vent Clamps



Part #	Mfg #	Description	Price
113849	1484	4" Dryer Vent Hood	6.15
118832	DVCS-4	4" Clamp for Dryer Vent Kit	0.85

Heating

# 1•800•MetPipe

## www.MetPipe.com



## Venting

### Protech FasNSeal® AL29-4C® Direct Vent System Stainless Steel Chimney Relining Parts

- Built-in gasket & locking band

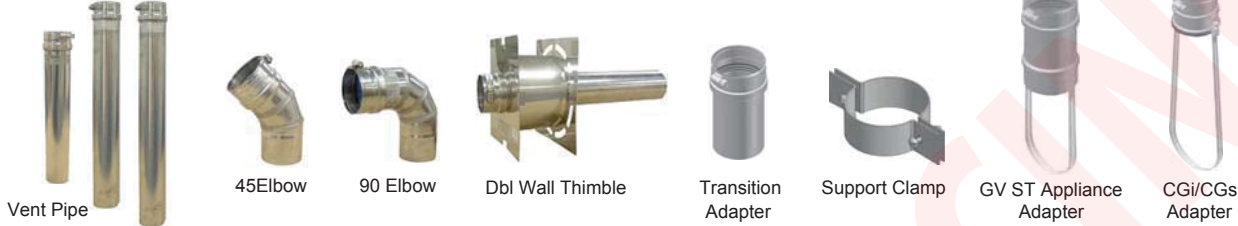

Vent Pipe

45 Elbow

90 Elbow

Dbl Wall Thimble

Transition Adapter

Support Clamp

GV ST Appliance Adapter

CGI/CGs Adapter

Part #	Mfg #	Part#	Diameter	Description	Price
194125	300001	FSVL603	3"	6" Vent Pipe	17.87
194167	300045	FSVL1803	3"	18" Vent Pipe	34.94
194168	300060	FSVL2403	3"	24" Vent Pipe	44.34
194216	300075	FSVL3603	3"	36" Vent Pipe	55.27
863184	300090	FSVL6003	3"	60" Vent Pipe	96.70
194132	300018	FSVL1206	6"	12" Vent Pipe	23.71
194219	300250	FSAVL3	3"	18" Adjustable 2" to 14" Vent Pipe	36.32
194217	300130	FSELB4503	3"	45° Elbow	53.50
194218	300160	FSELB9003	3"	90° Elbow	62.84
194220	300280	FSWT3	3"	Double Wall Thimble	75.31
194221	300236	FSHDT3	3"	Horizontal Drip Tee	47.44
194222	300187	FSBS4	4"	Bird Screen	22.00
194224	300360	FSCL3	3"	Support Clamp	18.21
194225	300349	FSA-WEIL-CGI3	3"	Weil McLain CGI/CGs Adapter	42.47
197301	300355	FSA-WEIL-GV3	3"	Weil McLain GV Gold Series 3 GV ST Adapter	39.57
194226	300358	FSA-WEIL GVTEE3	3"	Weil McLain GV Gold Series 3 GV Tee	30.43

### Smoke Pipe



1/2 Length (24in)

Part #	Size	Gauge	Price
9648	3"	26	3.82
9649	4"	26	4.67
9650	5"	26	5.92
9651	6"	26	6.32
9652	7"	26	7.23
9653	8"	26	8.00
52009	9"	26	9.58
45520	10"	26	11.12

Full Length (60in)

Part #	Size	Gauge	Price
9654	3"	26	5.50
9655	4"	26	6.46



## Custom Reporting

*Need a year's worth of your purchase history? No problem! Our custom reporting capabilities allow us to get you the information you need – quickly.*

Prices & specifications are subject to change.

Our state of the art pipe shop offers cutting, threading, grooving and make-ons up to 36in!

Heating





## Smoke Pipe

### Smoke Pipe (Continued) Full Length (60in)

Part #	Size	Gauge	Price
9656	5"	26	7.87
9657	6"	26	8.75
9658	7"	26	10.46
9659	8"	26	11.15
41798	9"	26	14.35
42962	10"	26	15.28

### Smoke Pipe Fittings

#### Smoke Caps



Part #	Size	Gauge	Price
124541	3"	26	10.46
53420	4"	26	10.46
124542	5"	26	10.46
111404	6"	26	10.46
42847	7"	26	12.48
38122	8"	26	13.39
52226	9"	26	14.83
52228	10"	26	17.23

#### Smoke 45-Elbows



Part #	Size	Gauge	Price
9666	3"	26	4.99
9667	4"	26	5.42
9668	5"	26	6.14
9669	6"	26	6.78
9670	7"	26	8.40
9671	8"	26	9.23
41797	9"	26	12.11
42961	10"	26	12.48

#### Smoke 90-Elbows



Part #	Size	Gauge	Price
9660	3"	26	3.71
9661	4"	26	4.11
9662	5"	26	4.43
9663	6"	26	4.91
9664	7"	26	5.42

### Smoke 90-Elbows (Continued)

Part #	Size	Gauge	Price
9665	8"	26	6.30
52169	9"	26	9.47
42960	10" 100°	26	10.51

#### Smoke Increasers



Part #	Size	Gauge	Price
37284	3" x 4"	26	11.98
36580	3" x 5"	26	11.98
52243	3" x 6"	26	11.98
38866	4" x 5"	26	11.98
52245	4" x 6"	26	11.98
48377	5" x 6"	26	11.98
52247	5" x 7"	26	13.98
46585	6" x 7"	26	13.98
40701	6" x 8"	26	15.95
37185	6" x 9"	26	18.00
40373	7" x 8"	26	15.95
43047	7" x 9"	26	18.00
52234	7" x 10"	26	20.00
52235	8" x 9"	26	18.00
52236	8" x 10"	26	20.00
47818	8" x 12"	26	22.88
41796	9" x 10"	26	20.00
42956	10" x 12"	26	22.88

#### Reducers

Part #	Size	Gauge	Price
9678	4" x 3"	26	11.98
45731	7" x 6"	26	13.98
38120	8" x 6"	26	15.95

#### Plugs



Part #	Size	Gauge	Price
51880	3"	26	10.46
53150	4"	26	10.46
38863	5"	26	10.46
38861	6"	26	10.46
43982	7"	26	12.48
48159	8"	26	13.39
38862	9"	26	14.83
52227	10"	26	17.23

### Smoke Tees



Part #	Size	Gauge	Price
9672	3"	26	18.88
9673	4"	26	19.74
9674	5"	26	20.54
9675	6"	26	21.18
9676	7"	26	22.00
9677	8"	26	27.20
52011	9"	26	41.47
42959	10"	26	40.56

#### Thimbles



Part #	Size	Gauge	Price
52208	3" 4"	26	4.94
49083	4" 4"	26	4.94
52230	5" 4"	26	4.94
45442	6" 4"	26	4.94
42896	7" 4"	26	5.44
44329	8" 4"	26	6.22
43046	9" 4"	26	7.20

### Smoke Wyes



Part #	Size	Gauge	Price
52254	4"	26	31.58
38864	5"	26	34.06
36990	6"	26	37.39
52255	7"	26	47.31
38106	8"	26	47.63

Prices & specifications are subject to change.

Our office hours are 7am to 4:30pm and counter hours 6am to 4:30pm Monday through Friday.



# Circulators



## Circulators

### Grundfos VersaFlo UPS Series Circulators

- Ideal for pumping water in heating and air conditioning systems as well as water in domestic hot-water systems
- 3 speed motors
- Water cooled rotors - The rotors are designed so that the water being pumped surrounds the rotor, cooling and lubricating the shaft and bearings
- Pumps are canned rotor type meaning the pump & motor form an integral unit without shaft seal and with only two gaskets for sealing
- Built-in thermal overload switch
- Cast iron or bronze pump housings available



Part#	Mfg#	Housing	HP	Phase	Speed	Volts	Flow GPM	Head Feet	Price
909033	UPS-32-40/4	Cast Iron	1/3	Single	3	115V	9-52	1-11	758.21
894999	UPS-32-40/4	Bronze	1/3	Single	3	115V	9-52	1-11	1285.34
170314	UPS-32-80/2	Cast Iron	1/2	Single	3	115V	9-67	1-25	770.02
166298	UPS-32-160/2	Cast Iron	3/4	Single	3	115V	9-76	1-45	1019.47
909047	UPS-40-80/2	Cast Iron	3/4	Single	3	115V	13-105	1-30	1006.35

### Grundfos SuperBrute Series Circulators

Grundfos team of SuperBrutes covers all domestic hydronic applications with only three circulators.

- Quick connect terminals – for easy installation
- Removable check valve – eliminates the need for an in-line flow check
- Ceramic bearings – ensures years of quiet, trouble free operation
- Internal lip seal and filter – keeps debris out of rotor can
- Backed by an industry leading three-year warranty



#### SuperBrute for Standard Hydronic Applications

- Flanged Connections
- UPS 15-58 features a rotated flanged housing

Part#	Mfg#	Housing	HP	Phase	Speed	Volts	Flow GPM	Head Feet	Price
226959	UPS 15-58 FC	Cast Iron	1/25	Single	3	115V	0-17	0-19	114.88
873049	UPS 15-58 FRC	Cast Iron	1/25	Single	3	115V	0-17	0-19	114.88
908982	UPS 15-55 SFC	Stainless Steel	1/12	Single	3	115V	0-25	0-18	344.64

#### SuperBrute for Applications Requiring Higher Head

- Flanged Connections

Part#	Mfg#	Housing	HP	Phase	Speed	Volts	Flow GPM	Head Feet	Price
898351	UPS 26-99 FC	Cast Iron	1/6	Single	3	115V	0-34	0-32	336.76
45225	UPS 26-99 BFC	Bronze	1/6	Single	3	115V	0-34	0-32	500.88

#### SuperBrute for Applications Requiring Lower Head, Higher Flow

- Flanged Connections

Part#	Mfg#	Housing	HP	Phase	Speed	Volts	Flow GPM	Head Feet	Price
856751	UPS 43-44 FC	Cast Iron	1/6	Single	3	115V	0-63	0-14	388.62
909030	UPS 43-44 BFC	Bronze	1/6	Single	3	115V	0-63	0-14	537.64

Heating



## Circulators



### Grundfos Alpha Closed Loop Circulator Pump

- AutoAdapt measures system changes automatically
- Maximizes energy savings by incorporating a permanent magnet motor design, power consumption is now reduced by 50%.
- Easy-to-use operation
- Select a mode with the touch of a button
- Easy-to-read LED display show flow and power consumption
- Simple plug connections; no wiring required



Part#	Mfg#	Housing	HP	Phase	Speed	Volts	Flow GPM	Head Feet	Price
926803	ALPHA 15-55 F/LC	Cast Iron	1/17	Single	3	115V	0-21	0-19	213.35

### Grundfos MAGNA/UPE Series 2000

- The Grundfos MAGNA circulator pumps are designed for air conditioning and heating systems in buildings on any scale. Innovative and intelligent, the MAGNA is based on a permanent-magnet motor that ensures maximum efficiency.
- Highly efficient, with communication facilities
- AUTOADAPT control mode as default setting, suitable for most applications
- Integrated differential pressure control (proportional and constant pressure control)
- Low noise
- High starting torque
- Automatic night setback
- Motor based on permanent-magnet/compact-stator technology
- Integrated frequency converter
- Self-venting pump housing
- Stainless steel pump housing
- Wireless remote control, R100
- Communication via GENibus or LON.



Heating

Part#	Mfg#	Housing	HP	Phase	Speed	Volts	Port to Port	Port Size(mm)	Price
918565	40-120F	Cast Iron	1/3	Single	1	230-240V	8-1/2"	40mm	1663.45
926718	65-120F	Cast Iron	1/3	Single	1	230-240V	11-1/2"	65mm	2873.95

### Grundfos UP43-75F Closed Loop Cast Iron Circulator Pump

- Grundfos UP43-75F is a cast iron circulator pump with high flow, medium head characteristics. The Grundfos UP43-75F model is primarily used in closed loop residential and light commercial heating applications, such as radiant heating, hydronic heating (baseboards, radiators, fan coils), solar and many others.
- Built-in motor protection.
- Whisper-quiet operation for sound sensitive installations.
- (2) Gaskets (O-rings) Included.
- UL/CSA listed.
- Applications:
  - Radiant heating systems
  - Hydronic, Fan coil and Solar heating applications



Part#	Mfg#	Housing	HP	Phase	Speed	Volts	Flow GPM	Head Feet	Price
945020	UP43-75F	Cast Iron	1/6	Single	1	115V	44.5	0-25	Call

Prices & specifications are subject to change.

You can check stock availability, pricing and place orders online at [www.MetPipe.com](http://www.MetPipe.com).



## Circulators



### Grundfos UP10-16BN5/TLC Bronze Body Circulating Pump

- Grundfos Comfort series pumps, such as the UP10-16BN5/TLC model are most commonly used for domestic hot water recirculation applications, and can be also used for other small heating and recirculation projects.
- Timer and Line-cord;
- Whisper quiet operation for sound sensitive installations;
- Bronze body
- 1/2" NPT



Part#	Mfg#	Housing	Amps	Phase	Speed	Volts	Flow GPM	Head Feet	Price
916210	UP10-16BN5-ATLC	Bronze	0.23	Single	1	115V	0-3.5	0-5.4	303.29

### Grundfos Comfort System

- Retrofits to existing plumbing
- No return line required
- Installs in less than one hour
- No electricity needed under the sink
- Built-in timer & line-cord
- Uses less energy than a 25-watt light bulb
- Saves up to 12,000 gallons of water per year



Part#	Mfg#	Housing	HP	Phase	Speed	Volts	Flow GPM	Head Feet	Price
908996	UP-15-10SU7P	Cast Iron	1/25	Single	3	115V	0-3.4	0-3.5	336.11

Heating

## – How the Comfort System Works

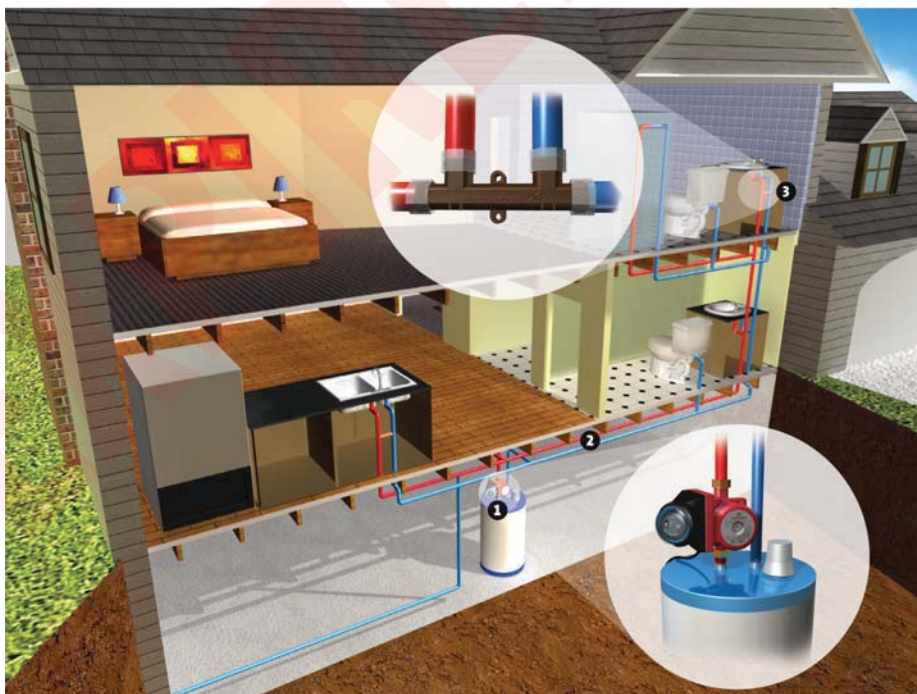

### THE GRUNDFOS COMFORT SYSTEM

**1 pump:** The Comfort System is installed on your hot water heater to help pull "recycled" water back to the hot water heater to be reheated and recirculated.

**2 pipes:** Hot water is always at hand because it circulates from the hot water line to the cold water line and back to the hot water heater.

**3 valve:** Placed under the sink farthest from the hot water heater, the valve helps regulate the flow from the hot water line to the cold water line.

Prices & specifications are subject to change.



## Circulators



### Circulator Accessories

#### Cast Iron Flanges

- Cast Iron
- Gasket and Bolts Included



Part#	Mfg#	Description	Price
232982	519601	3/4" Cast Iron flange set for all Grundfos pumps	8.80
908981	519602	1" Cast Iron flange set for all Grundfos pumps	8.80
111072	519603	1-1/4" Cast Iron flange set for all Grundfos pumps	8.80
156733	519604	1-1/2" Cast Iron flange set for all Grundfos pumps	8.80

#### Bronze Flanges

Part#	Mfg#	Description	Price
865401	519561	3/4" Bronze flange set for all Grundfos pumps	39.65
156409	519652	1" Bronze flange set for all Grundfos pumps	39.65
895000	96409356	1-1/4" Bronze flange set for all Grundfos pumps	35.26
804390	539615	1-1/2" Bronze flange set for all Grundfos pumps	54.95

#### Grundfos Dielectric Isolation Valves

- Full port shut-off ball valve
- Dielectric isolation = no galvanic (dissimilar metal) corrosion
- Service pump without draining system
- Swivel flange allows optimum pump mounting position
- Female NPT Connection



Part#	Mfg#	Description	Price
909079	591203	3/4" FNPT Dielectric Isolation Valve	37.49
909073	591204	1" FNPT Dielectric Isolation Valve	44.25
909080	591205	1-1/4" FNPT Dielectric Isolation Valve	49.30
909081	591206	1-1/2" FNPT Dielectric Isolation Valve	53.64

Heating



# Circulators

## Cartridge Circulators

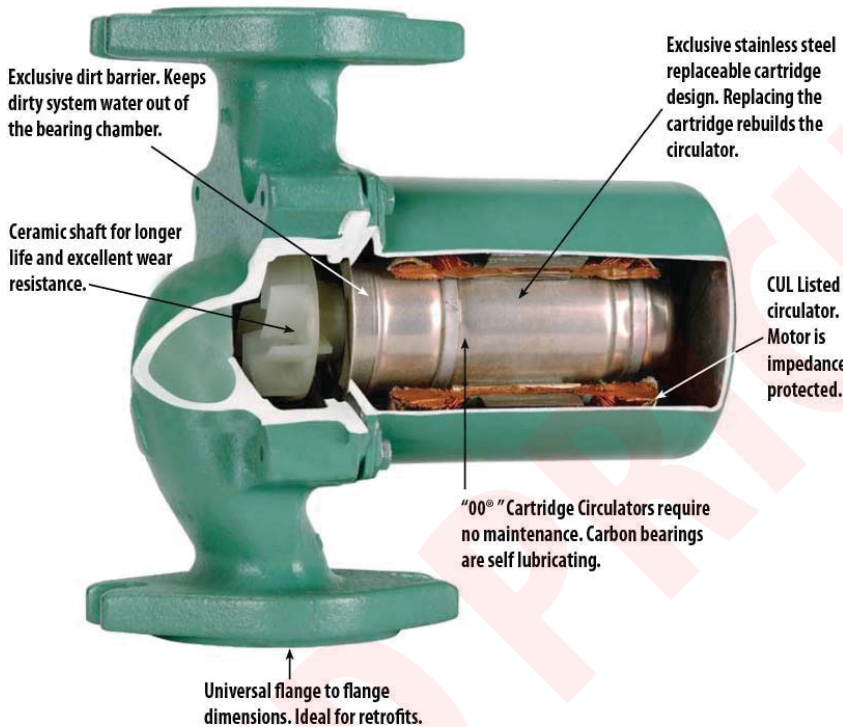

### Model 006 Stainless Steel Cartridge Circulators

- For use in circulation of hot & chilled fresh water in open & closed loop applications
- Can be used for domestic hot water recirculation, heat recovery units, water source heat pumps, drain down open loop solar systems & potable water systems
- 125 psi Pressure rating
- 220°F Temperature rating
- 1/40 HP @ 3250 rpm
- 115V/60Hz/1Ph



Part #	Mfg #	Casing	Connections	Price
929457	006-ST	Stainless Steel	3/4" FIP	204.23

### Model 007 Stainless Steel Cartridge Circulators

- For use in hydronic heating systems, chilled fresh water systems & domestic water systems
- Can be used in the typical residential hydronic heating system, to add a zone addition, zoning with circulators & potable water system
- 125 psi Pressure rating
- 240°F Temperature rating
- Flanged
- 1/25 hp @ 3250 rpm
- 115V/60Hz/1Ph



Part #	Mfg #	Casing	Price
924388	007-SF	Stainless Steel	333.60

Heating



## Circulators



### Model 0010 Cartridge Circulators

- For use in hydronic heating, chilled water & potable water systems
- Available in cast iron & bronze for closed or open loop systems
- 125 psi Pressure rating
- 225°F Temperature rating
- Flanged
- 1/15 hp @ 3250 rpm, 115V/60Hz/1Ph



Part #	Mfg #	Casing	Price
924387	0010-SF	Stainless Steel	410.31

### Model 0011 Stainless Steel Cartridge Circulators

- High velocity/high head for residential and light commercial closed loop hydronic systems and open loop domestic fresh water systems
- High head-medium flow for high pressure drop boilers, fan coil units, heat exchangers, large radiant heating systems and heat recovery units/earth loop systems
- 125 psi Pressure rating
- 220°F Temperature rating
- Flanged
- 1/7 hp @ 3250 rpm, 115V/60Hz/1Ph



Part #	Mfg #	Casing	Price
40646	0011-SF	Stainless Steel	370.39

### 100 Series Circulators

- Resilient mounted, split phase motor with built-in overload protector
- Equipped with sleeve bearings for quiet operation
- One piece non-ferrous impeller
- Stainless steel shaft
- Rugged bronze sleeve bearing
- Two piece carbon/ceramic seal assembly
- Durable one piece spring coupling
- No special tools required
- Allow easy isolation and service



Part #	Mfg #	Casing	Flange Size	HP	RPM	Price
15768	110	Cast Iron	3/4", 1", 1-1/4" 1-1/2"	1/12	1725	310.76
15784	110-B24	Bronze	3/4", 1", 1-1/4" 1-1/2"	1/12	1725	600.72
53771	111-B8	Bronze	3/4", 1", 1-1/4" 1-1/2"	1/8	1725	1033.65
15773	111-8	Cast Iron	3/4", 1", 1-1/4" 1-1/2"	1/8	1725	598.13
40281	112-14	Cast Iron	3/4", 1", 1-1/4" 1-1/2"	1/3	3450	723.53
38247	112-B14	Bronze	3/4", 1", 1-1/4" 1-1/2"	1/3	3450	1157.12
166088	113B	Bronze	3/4", 1", 1-1/4" 1-1/2"	1/8	1725	1230.72
15778	120-13	Cast Iron	2"	1/6	1725	743.15
38348	120B	Bronze (w/Flange)	2"	1/6	1725	1483.98

Prices & specifications are subject to change.

Our state of the art pipe shop offers cutting, threading, grooving and make-ons up to 36in!



## Circulators

### Circulator Flanges Ductile Iron Freedom Flanges

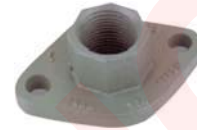

Part #	Mfg #	Flange Size	Flange Sets For	Price
14997	110-251F	3/4"	005, 007-0011, 0013, 0014, 110-113	9.45
14998	110-252F	1"	005, 007-0011, 0013, 0014, 110-113	9.45
14999	110-253F	1-1/4"	005, 007-0011, 0013, 0014, 110-113	9.45
15000	110-254F	1-1/2"	005, 007-0011, 0013, 0014, 110-113	9.45

### Bronze Threaded Freedom Flanges



Part #	Mfg #	Flange Size	Flange Sets For	Price
203773	110-251BF	3/4"	005, 007-0011, 0013, 0014, 110-113	31.62
14993	110-252BF	1"	005, 007-0011, 0013, 0014, 110-113	31.62
14994	110-253BF	1-1/4"	005, 007-0011, 0013, 0014, 110-113	31.62
14995	110-254BF	1-1/2"	005, 007-0011, 0013, 0014, 110-113	31.62

### Flat Flange Gaskets



Part #	Mfg #	Description	Price
15001	T36	Flat flange gasket for Taco & B&G pumps	0.70

### Multi-Function Circulator Flanges

- Provides operation mode and isolation mode
- Includes nuts, bolts and gasket



Part#	Mfg#	Description	Price
861841	34IPSMFCFWP	3/4" IPS with Purge for Taco & B&G Circulators	17.40
228496	34IPSMFCFLP	3/4" IPS less Purge for Taco & B&G Circulators	15.23
229378	34CMFCFLP	3/4" Sweat less Purge for Taco & B&G Circulators	15.23
861843	34CMFCFWP	3/4" Sweat with Purge for Taco & B&G Circulators	17.40
861635	1IPSMFCFWP	1" IPS with Purge for Taco & B&G Circulators	16.88
228497	1IPSMFCFLP	1" IPS less Purge for Taco & B&G Circulators	16.88
232372	1CMFCFWP	1" Sweat with Purge for Taco & B&G Circulators	22.80
861663	1CMFCFLP	1" Sweat less Purge for Taco & B&G Circulators	16.88
861845	114IPSMFCFWP	1-1/4" IPS with Purge for Taco & B&G Circulators	24.98
861844	114IPSMFCFLP	1-1/4" IPS less Purge for Taco & B&G Circulators	18.75
874035	114CMFCFWP	1-1/4" Sweat with Purge for Taco & B&G Circulators	24.98
874032	114CMFCFLP	1-1/4" Sweat less Purge for Taco & B&G Circulators	18.75

Heating





## Circulators

### Taco Circulator Accessories & Parts

#### Taco Pump Motors

- 115V, 60HZ



Part #	Mfg #	HP	Fits Circulator(s)	Price
42256	110-185RP	1/8	111, 113	590.48
50875	110-223RP	1/12	110, 117	364.09
50629	120-105RP	1/6	120	Call

#### Taco Replacement Pump Couplers



Part #	Mfg #	Fits Circulator(s)	Price
50879	110-009RP	110, 111, 113, 120	33.90

#### Taco Replacement Bearing Assemblies



Part #	Mfg #	Fits Circulator(s)	Price
50569	110-361RP	110	84.39
50570	110-362BRP	110B	277.74
50882	110-058RP	111	337.83
49715	111-059BRP	111B	528.04
50884	113-013RP	113	Call
50898	113-012BRP	113B	Call
50885	120-067RP	120	484.28
50899	120-068BRP	120B	748.02

#### Taco Replacement Seal Kit

- Two piece carbon/ceramic seal



Part #	Mfg #	Fits Circulator(s)	Price
37483	110-275RP	110, 111, 113, 120	51.58

#### Taco Replacement Body Gaskets



Part #	Mfg #	Fits Circulator(s)	Price
50325	110-364RP	110, 113, 117	11.50
196481	120-009RP	120	Call



### Oil-Lubricated Circulators - 3-Piece

- 115V with built-in overload protection
- Replaceable resilient motor mounts
- Noise dampening coupler
- Long bronze sleeve bearings maintain exact shaft alignment
- Precision ground pump shaft is oversized to provide large bearing surfaces
- Mechanical seal is designed to withstand wide range of water temperatures, pressures, additives and dissolved solids
- Centrifugal impeller prevents accumulation of air at seal faces to assure long life
- Maximum working pressure: 125 psi
- Maximum operating temperature:
  - Standard seal - 225°F continuous
  - Special seals - 250°F continuous



#### Series 100

- 1/12 hp
- Flange sizes (NPT): 3/4", 1", 1-1/4", 1-1/2"
- Flanges not included

Part #	Mfg #	Model	Construction	Price
15746	106189	100NFI	Cast Iron	450.00
15752	106197	100BNFI	Bronze	730.00

#### Series PR

- 1/6 hp
- Flange sizes (NPT): 3/4", 1", 1-1/4", 1-1/2"
- Flanges not included

Part #	Mfg #	Model	Construction	Price
43125	102208	PR-AB	Bronze	1510.00

#### Series HV

- 1/6 hp
- Flange sizes (NPT): 1", 1-1/4", 1-1/2"
- Flanges not included



Part #	Mfg #	Model	Construction	Price
49440	102210	HV-NFI	Cast Iron	780.00
44722	102213	HV-BNFI	Bronze	1260.00



## Circulators

### 2" Flange



- 1/6 hp

Part #	Mfg #	Model	Construction	Price
15751	102214	2NFI-BI	Cast Iron	920.00
51112	102217	2BNFI	Bronze	1610.00

### Flat Flange Gaskets



Part #	Mfg #	Description	Price
15001	T36	Flat flange gasket for Taco & B&G pumps	0.70

### Series NRF



- A residential or light commercial, maintenance free, axial flanged, in-line, cast iron, wet rotor, circulation pump for hydronic heating systems. UL and cUL listed.
- High starting torque provides years of trouble-free start-ups
- Unique B&G DuraGlide Bearing System assures whisper-quiet, maintenance-free operation
- Closed impeller design improves operating efficiency
- 1/15 HP
- Cast Iron
- 115v 3-Speed 1 Phase
- RPM: 2950
- Max PSI: 150 psi Max Temp (F): 225°F
- Warranty: 3 Year

Part #	Mfg #	Model	Construction	Price
930533	103417	NRF-25	Cast Iron	Call

## Pump Motors & Accessories

### Power Pack Motors

- 115V, 60Hz



Part #	Mfg #	Description	Price
15030	111034	1/12 hp for Series 100	295.00
15029	111031	1/6 hp for Series PR	420.00
15032	111061	1/6 hp for Series HV	440.00

### Pump Couplers

- Flexible spring coupler dampens vibration and noise



Part #	Mfg #	Description	Price
15017	118473	Spring Type 1/2" x 1/2" for PD-35, PD-37, 60 "AA", 1522	45.12
15018	118705	Cast Iron for Series 100, PR, HV, 2"	17.38
15019	118723	For 2-1/2", LD-3, HD-3, Obs HLD-3, Obs HHD-3	28.00
114408	186410	5/8" x 1/2" for PD-38, PD-40, Obs PD-39, 60 "A"	62.50

## Companion Flanges



### NPT Connections

Part #	Mfg #	Size	Fits Models	Price
44295	FR-75	3/4"	100, PR	34.80
196930	FR-100	1"	100, PR	15.12
197321	FR-125	1-1/4"	100, PR	15.12
197320	FR-150	1-1/2"	100, PR	14.93
44276	101012	1"	100B, PR-AB	34.80
44277	101013	1-1/4"	100B, PR-AB	34.80
44278	101014	1-1/2"	100B, PR-AB	34.80
54617	101005	1"	HV	16.00
54618	101006	1-1/4"	HV	16.00
44274	101007	1-1/2"	HV	16.00
43470	101015	1"	HVB	47.39
111777	101016	1-1/4"	HVB	47.39
50098	101017	1-1/2"	HVB	47.39

### Seal Kits



Part #	Mfg #	Description	Price
15035	118681	#7 Seal Kit (Buna) for Series 100, HV, 2", PR, 2-1/2", LD-3, HD-3, PD-35, PD-37, 60 "AA", 1522. MF60 with 5-1/4" x 6-1/4" Impellers	31.50
15036	186499	#2 Seal Kit (Buna) for PD-38, PD-40, 60 "A", 60 2-1/2F, MF 60 with 7" Impellers	123.00
15037	186862	#1 Seal Kit (Buna/Carbon/Ceramic) for Series 80, 90, 1510, 1531 Pumps	150.00



## Circulators

### Pump Motors & Accessories (Continued)

#### Seal Kits

Part #	Mfg #	Description	Price
49096	186826	Seal Kit (Buna/Carbon/Ceramic) for Old Design Series VSC and VSCS Pumps	450.00

#### Impellers



Part #	Mfg #	Description	Price
15026	118431	2-3/4" Bronze Impeller for 100BNFI & 100AB Pumps	51.00
41589	118436	3-3/8" Bronze Impeller for HVBNFI Pumps	126.00
15028	189132	2-3/4" NFI Impeller for Series 100 Pumps	20.00
15027	189128	3-3/8" NFI Impeller for 2BNFI, 2NFI & HV Pumps	88.00

#### Bearing Assemblies

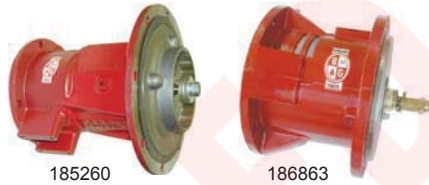

Part #	Mfg #	Description	Price
37429	185011	Small Frame BF for 1510	1030.00
15007	185260	BF PD/60 Sleeve Bearing for PD-38, PD-40, Obs PD-39, 60 "A"	1115.00
15008	186863	BF PD/60 Sleeve Bearing for PD-35, PD-37, 60 "AA", 1522	420.00
15009	189034	For Series 100	106.00
15016	189134	With Impeller, for Series 100	113.00
182454	189163	For HV & 2" AB Pumps	208.00
177927	189165	For 2BNFI & HVBNFI Pumps	245.00

#### Body Gaskets



Part #	Mfg #	Description	Price
15023	P57700	For PD-38, PD-40, Obs PD-39, 60 "A", MF 60 with 7" Impellers	4.35
15020	P04080	For Series 100	1.94
15021	P04890	For HV, 2", Obs 1", Obs 1-1/4", Obs 1-1/2", Obs 2", Obs HV	1.35
15022	P57410	For PD-35, PD-37, 60 "AA", 1522, MF 60 with 5-1/4" & 6-1/4" Impellers	1.70
38210	P48690	For 1510	12.60



### Flange Gasket Sets

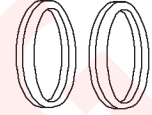

Part #	Mfg #	Description	Price
15024	118373	For PL-45, PL-50, HV, 60 1-1/2AA, 60 1-1/2A, MF 60 1-1/2"	5.95
15025	118378	For 2", 60 2AA, 60 2A, MF 60 2", PL-75, PL-130	8.10

### Oil



Part #	Mfg #	Description	Price
15034	118153	4 oz Oil Tube - Small	4.40

Heating

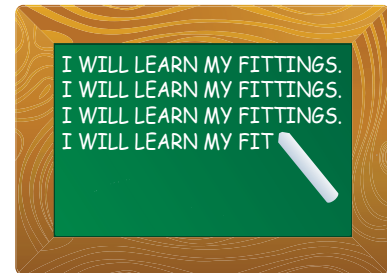

## Product Training

*Met Pipe offers training on every product we sell- from pumps to boilers. Let us organize a group training session for your team today!*



## Circulator Parts

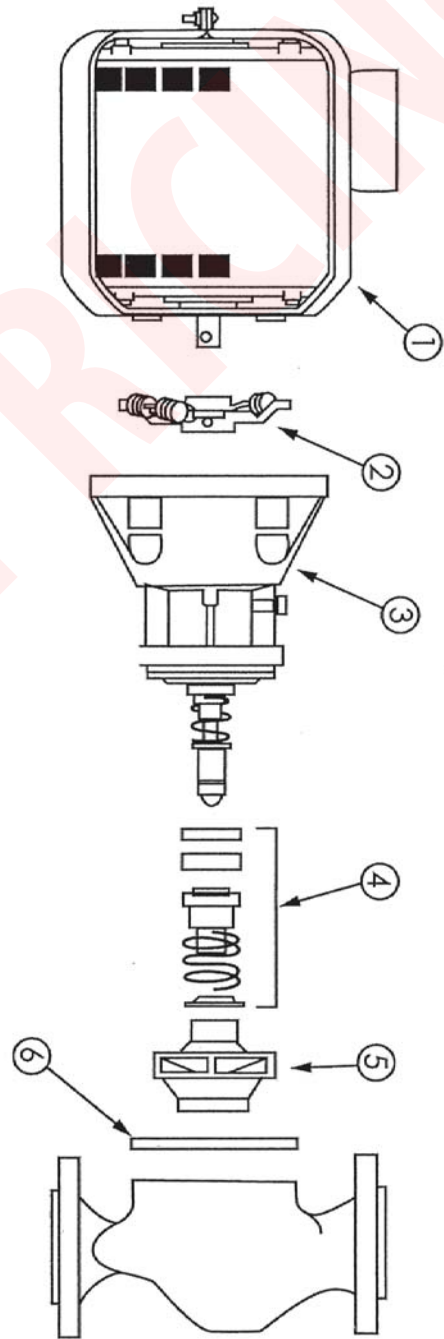

Description	B&G					Taco				
	<u>100</u> 100BNFI	PR PRB	HV HVB	2in 2in B	PD-35 PD-35B	<u>110</u> 110B	<u>111</u> 111B	<u>113</u> 113B	<u>120</u> 120B	
<b>#1 Power Pack</b>	111034	111031	111061	111061	111044	110-233RP	110-185RP	110-185RP	120-105RP	
<b>#2 Coupler</b>	118705	118205 118075	118705	118705 118075	118473	110-009RP	110-009RP	110-009RP	110-009RP	
<b>#3 Bearing Assembly</b>	118844 189034	189105	189163	189163 189165	186893	110-361RP 110-362RP	110-058RP 111-059BRP	113-013RP 113-012BRP	120-067RP 120-068RP	
<b>#4 Seal Kit</b>	118681	118681	118681	118681	118681	110-275RP	110-275RP	110-275RP	110-275RP	
<b>#5 Impeller</b>	118932 118431	118830 118612	189128 118436	189128 118436	118630 118627	110-207RP	111-053RP	113-009RP	120-038RP 120-054RP	
<b>#6 Body Gasket</b>	P04080	P05800	P04890	P04890	P57410	110-364RP	120-009RP	120-009RP	120-009RP	

Heating



## Valves

### Flo-Chek Valves

- Used in forced hot water heating system to prevent gravity circulation during periods when boiler is hot but space heating zone not wanted
- Maximum operating pressure: 125 psi
- Maximum operating temperature: 277°F
- Water or water/glycol media

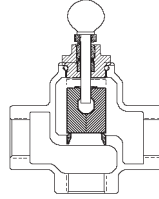

Cast Iron Universal Threaded

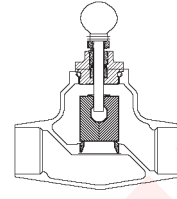

Bronze Sweat In-Line



Part #	Mfg #	Size	Body	Type	Connections	Resistance of Pipe Equivalent/CV	Price
36205	219	3/4"	Bronze	Horizontal	Sweat	143'/2.5	42.38
107729	241	1"	Bronze	Horizontal	Sweat	63.4'/7.7	55.71
36417	218	3/4"	Cast Iron	Universal	NPT	35.8'/5	36.42
36723	220	1"	Cast Iron	Universal	NPT	83.7'/6.7	37.74
37915	221	1-1/4"	Cast Iron	Universal	NPT	47.8'/17	57.24
40515	222	1-1/2"	Cast Iron	Universal	NPT	57.9'/23.5	109.91
51107	223	2"	Cast Iron	Universal	NPT	61.8'/43.8	158.04

### Zone Valves

#### 570 Gold Series Two-Way Heat Motor Zone Valves

- Bronze body
- Pump head operates in up to 65' of water
- Maximum working pressure: 125 psi
- Fluid temperature range: 40° to 240°F
- 24V, 60Hz, 0.9A
- 3-Year head warranty
- 5-Year body warranty



Part #	Mfg #	Connection	Normal Flow	Max PSI	CV	Price
14983	571	3/4" Sweat	4-1/2 - 6 GPM	125 PSI	6.1	112.64
14984	572	1" Sweat	6-10 GPM	125 PSI	7.0	129.30
14985	573	1-1/4" Sweat	10-16 GPM	125 PSI	7.2	151.11

#### Taco Z075C2-1 3/4" Zone Sentry Zone Valve (Sweat)

- The valve can be installed in any direction, in any orientation, and features a dependable 1/4 turn one-handed twistlock for easy operator removal.
- The actuator head is a snap to replace, and can be mounted to the valve body in either direction, great for tight baseboard jobs.
- The external LED shows you the full functionality of the valve's operation and thermostat status.
- 3/4" Sweat
- 24 VAC
- Normally Closed
- 4 Input Quick Connects
- Plug-in screw terminals make the ESP a breeze to install and operate.



Part #	Mfg #	Connection	Normal Flow	Fluid Temperature Range	Price
946535	Z075C2-1	3/4" Sweat	300 PSI	20°F to 240°F	98.79



# Valves

## Pressure Reducing Valves

- Low inlet pressure check valve helps prevent loss of system pressure if supply water drops below system pressure
- Convenient cleanable strainer is designed to prevent dirt and sediment from entering system
- Brass body
- Factory setting: 12 psig
- Adjustable range: 10 to 25 psig
- Maximum operating temperature: 225°F
- Maximum operating pressure: 125 psig
- "F" prefix includes fast fill feature



FB-38TU

Part #	Mfg #	Model	Connection	Price
134595	110193	FB-38TU	1/2" Union NPT/Sweat	68.50
14980	110196	B7-12	3/4" NPT	85.00

## Flo-Control™ Straight-Angle Valves

- For preventing gravity flow in forced water systems
- Permits summer-winter operation of indirect water heaters
- Combination straight-angle configurations permit installation in either horizontal or vertical pipe lines
- Manual operating position for vertical lift disc to permit gravity circulation
- Removable top cap
- Iron with screwed and flanged ends
- Asbestos-free packing and gasket



Part #	Mfg #	Model	Connection	Price
14960	107018	SA-1	1"	67.50
14961	107019	SA-1-1/4	1-1/4"	88.00

## Circuit SetterPlus® Calibrated Balance Valve

- Pre-balance design capability
- Proportional shut off
- Memory stop indicated
- Integral valved readout ports



Part #	Mfg #	Model	Connection	Price
43262	117412	CB-1/2S	1/2" Sweat	42.23
43263	117413	CB-3/4S	3/4" Sweat	47.02
135236	117401	CB-1S	1" Sweat	66.11
135054	117402	CB-1-1/4S	1-1/4" Sweat	90.90
111674	117403	CB-1-1/2S	1-1/2" Sweat	110.17
165853	117404	CB-2S	2" Sweat	157.00
44043	117414	CB-1/2	1/2" NPT	44.84

## Circuit SetterPlus® (Continued)

Part #	Mfg #	Model	Connection	Price
44044	117415	CB-3/4	3/4" NPT	44.84
44045	117416	CB-1	1" NPT	72.17
44046	117103	CB-1-1/4	1-1/4" NPT	101.91
38693	117104	CB-1-1/2	1-1/2" NPT	118.44
42446	117105	CB-2	2" NPT	168.01
39614	117106	CB-2-1/2	2-1/2" NPT	320.02
92008	117116	CB-2-1/2F	2-1/2" Flanged	446.19
41145	117117	CB-3F	3" Flanged	677.55
44915	117112	CB-4F	4" Flanged	1043.86
112937	117114	CB-6F	6" Flanged	1743.43

Quality Since 1911



## Brass Union Circulator Elbows (FIP x MIP)



Part #	Mfg #	Size	Price
1258	300	1"	28.59
1259	300	1-1/4"	36.74



## Industrial Radiator and Steam Valves

### Union Elbow - 90° - (FNPT x Male Union)

- Heavy-duty cast brass
- Non-Rising stem
- 15 psi WSP
- 60 psi Hot water non-shock



Part #	Mfg #	Size	Price
1257	4438T	3/4"	8.32

Heating



## Fittings

### Copper Red Ring Monoflo® Fittings

- Lets you use a single pipe to serve as both supply and return main
- Recommended for most installations, including cast-iron non-ferrous baseboards, free-standing radiation or convectors
- For most applications a second fitting can be used if higher resistance is required



Part #	Mfg #	Size	Price
14964	108119	3/4" x 1/2" (Return Only)	25.00
14965	108120	1" x 1/2"	25.00
14966	108121	1" x 3/4"	25.00
14967	108122	1-1/4" x 1/2"	26.00
14968	108123	1-1/4" x 3/4"	26.00
43485	108125	1-1/2" x 1"	34.29



### Fine/Line® 30 Baseboard Radiation

- For residential hot water heating
- Made with commercial grade, rust-resistant galvanized steel
- Fully modulating damper
- Extra-heavy support brackets with cutouts for return piping
- Double vent aluminum fins
- 7-7/8" High, 2-11/16" deep
- Nu-White baked enamel finish

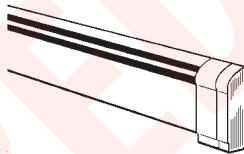

### 30-75 Complete Baseboard Package - Fine/Line® 30

- Complete baseboard package contains:
  - 3/4" Copper/aluminum heating element & enclosure
  - Expansion cradles
  - Support brackets
  - Damper vane
  - 2" Wide splice plate with 5' lengths and longer

Part #	Mfg #	Description	Price
112688	101401030	3' Complete Baseboard	26.38
36064	101401040	4' Complete Baseboard	35.17
36065	101401050	5' Complete Baseboard	43.97
36066	101401060	6' Complete Baseboard	52.76
36067	101401070	7' Complete Baseboard	61.55
36068	101401080	8' Complete Baseboard	70.34

### 30-DW Enclosure Only - Fine/Line® 30

- Complete assembly without element or expansion cradles

Part #	Mfg #	Description	Price
36060	101403030	3' Enclosure	17.55
36061	101403040	4' Enclosure	23.39
36062	101403050	5' Enclosure	29.24
36063	101403060	6' Enclosure	35.09
115792	101403070	7' Enclosure	40.94
115793	101403080	8' Enclosure	46.78

### Accessories - Fine/Line® 30

- Precision piano hinged
- Nu-White enamel finish

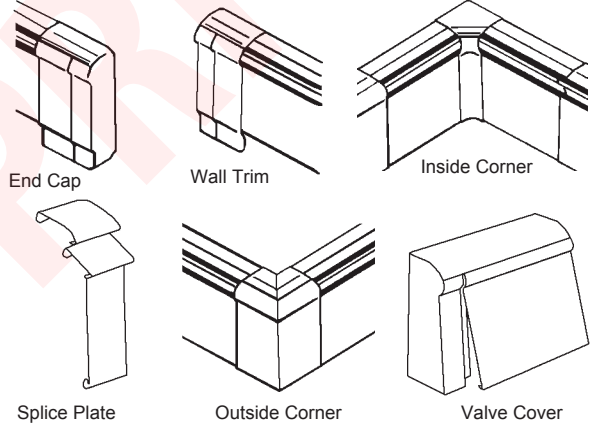

Part #	Mfg #	Description	Price
36058	101-405	4" Right End Cap	9.69
36057	101-404	4" Left End Cap	9.69
115797	101-407	4" Right Wall Trim	10.19
115796	101-406	4" Left Wall Trim	10.19
36059	101-410	90° Inside Corner	7.31
55622	101-411	135° Inside Corner	13.89
117256	101-422	2" Splice Plate	9.69
115802	101-414	90° Outside Corner	14.35
117261	101-415	135° Outside Corner	15.21
41650	101-409	7" 30A Filler Sleeve	10.59
117258	101-408	14" 30A Filler Sleeve	14.24
117608	101-418	8" 30A Right Valve Cover	20.31
117255	101-417	8" 30A Left Valve Cover	19.99
15921	101-020	Support Bracket w/Damper Pivot	4.84
15924	101-025	T-Shot Nailing Tool	32.62
128636	101-036	Damper Pivots Only	0.78



# Baseboard Heat

## Multi/Pak® 80 Baseboard Radiation

- Heavy-duty high output for hot water or steam
- Ideal for deluxe residential or light commercial heating
- Interchangeable heating elements, airfoil damper
- Dent proof, kick-proof front panel
- 8-7/8" High, 3-1/2" deep
- Nu-White baked enamel finish

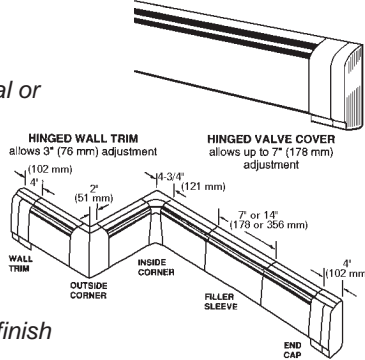

### 83A Complete Baseboard Package Multi/Pak® 80

- Complete baseboard package contains:
  - Fully assembled baseboard with H-3 element
  - 3/4" Copper/alum "regular" fin brackets
  - Expansion cradles
  - Damper
  - Splice plate set included with 5' and longer

Part #	Mfg #	Description	Price
112694	103401030	3' Complete Baseboard	44.82
41645	103401040	4' Complete Baseboard	59.76
117598	103401050	5' Complete Baseboard	74.69
41644	103401060	6' Complete Baseboard	89.63
41642	103401070	7' Complete Baseboard	104.57
117600	103401080	8' Complete Baseboard	119.51

### 80D Enclosure Only

- Nu-White baked enamel finish

Part #	Mfg #	Description	Price
117601	103409030	3' Enclosure	23.84
117602	103409040	4' Enclosure	31.79
117603	103409050	5' Enclosure	39.74
117604	103409060	6' Enclosure	47.68
117605	103409070	7' Enclosure	55.63
117606	103409080	8' Enclosure	63.58

### Snap-On Hinged Accessories - Multi/Pak® 80

- Precision piano hinge

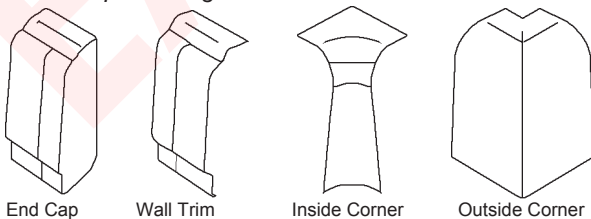

Part #	Mfg #	Description	Price
117264	103-411	4" Right End Cap	12.62
117265	103-412	4" Left End Cap	12.62

## Multi/Pak® 80 Baseboard Radiation (Continued)

### Snap-On Hinged Accessories - Multi/Pak® 80

Part #	Mfg #	Description	Price
117266	103-413	4" Right Wall Trim	12.62
117267	103-414	4" Left Wall Trim	12.62
117491	103-415	14" Filler Sleeve	16.38
117609	103-416	7" Filler Sleeve	12.72
41647	103-417	90° Inside Corner	8.63
117488	103-418	135° Inside Corner	20.31
117492	103-421	90° Outside Cover	19.85
117493	103-422	135° Outside Cover	22.94
117609	103-416	7" Filler Sleeve	12.72
117491	103-415	14" Filler Sleeve	16.38
117489	103-424	Right Valve Cover	23.29
117490	103-425	Left Valve Cover	23.29

## Multi/Pak® 90 Baseboard Radiation

- Commercial baseboard radiation for water or steam
- 18 Gauge galvanized steel top & front cover
- External cover accessories are telescopic for uneven floors & walls
- Slope-top, 2-piece interlocking top cover/front cover mount on wall brackets
- Locks in place to provide the same shape and rigidity
- Choice of 12 elements
- 14" High (1 tier), 5-1/4" deep
- Nu-White backed enamel finish



### 90-14 Complete Enclosure Assembly - Multi/Pak® 90

- Complete 2-piece baseboard package contains:
  - Top & front cover
  - Required brackets
  - Required element hangers

Part #	Mfg #	Description	Price
111497	185100030	3' Complete Enclosure	42.25
132252	185100040	4' Complete Enclosure	56.33
35774	185100050	5' Complete Enclosure	70.41
35775	185100060	6' Complete Enclosure	84.49
116695	185100070	7' Complete Enclosure	98.57
51253	185100080	8' Complete Enclosure	112.65

Prices & specifications are subject to change.

Metropolitan Pipe offers FREE DELIVERY in the Greater Boston area.





## Baseboard Heat



### Telescopic Accessories - Multi/Pak® 90

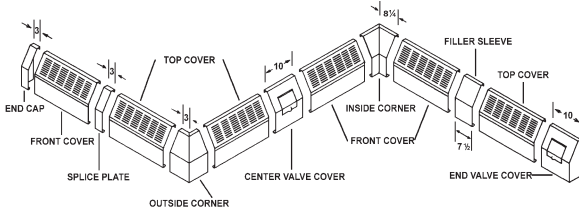

Part #	Mfg #	Description	Price
35771	185-101	3" Telescopic Right End Cap	20.74
35770	185-102	3" Telescopic Left End Cap	20.74
116697	185-107	90° Telescopic Inside Corner	35.30
183305	185-108	90° Telescopic Outside Corner	34.11
51181	185-109	10" Telescopic Right End Cap	38.84
51564	185-110	10" Telescopic Left End Cap	38.84
229645	185-113	10" Telescopic Center Valve Cover	30.64
229644	185-123	135° Telescopic Outside Corner	193.97
167380	185-111	10" Slotted Right End Cap	41.24
51533	185-112	10" Slotted Left End Cap	41.24

### Hangers/Brackets

#### SC Hanger for Multi/Pak®

- Guide rod to provides 11-5/16" lateral expansion movement, 1-1/8" vertical pitch adjustment

Part #	Mfg #	Description	Price
38561	107-220	SC Hanger, Electro Galvanized	3.79

#### Bracket Assembly for Multi/Pak®

- Mounting slots provide 3/4" height adjustment

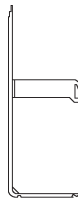

Part #	Mfg #	Description	Price
108033	180-300	Includes SC Hanger	14.57

### Element Hanger

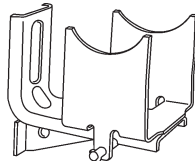

Part #	Mfg #	Description	Price
49443	108-173	M-1 Expansion Hanger	7.23

### Elements

- Fin-tube elements
- Each fin has interlocking tongue-and-groove collars for fin stability
- Expanded copper tubing ends eliminate couplings, reduce soldering
- Steel elements are factory threaded both ends
- Natural finish

#### E-75 Element Only for Slant-Fin 30 Series

- 2-5/16" x 2-1/8" Aluminum fins
- 55 Fins per foot
- Compact model features double bent aluminum fins for extra heating surface in slimmer profile
- Includes plastic expansion cradles
- Active element length: 3" less than total length



Part #	Mfg #	Model	Description	Price
15952	101002030	30	3' x 3/4" Copper Tube	20.22
15953	101002040	30	4' x 3/4" Copper Tube	26.96
15954	101002050	30	5' x 3/4" Copper Tube	33.34
15955	101002060	30	6' x 3/4" Copper Tube	40.43
15956	101002070	30	7' x 3/4" Copper Tube	47.17
15957	101002080	30	8' x 3/4" Copper Tube	53.34

#### C Series Copper with Aluminum Fin Elements

- 4-1/4" x 4-1/4" x .020" Aluminum fins
- 40 Fins per foot
- Active element length: 5-1/4" less than total length

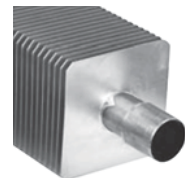

Part #	Mfg #	Model	Description	Price
134926	C340-003	C-340	3' x 3/4" Copper Tube	52.32
136044	C340-004	C-340	4' x 3/4" Copper Tube	69.76
136043	C340-005	C-340	5' x 3/4" Copper Tube	87.20
136042	C340-006	C-340	6' x 3/4" Copper Tube	104.64
170886	C340-007	C-340	7' x 3/4" Copper Tube	122.08
136041	C340-008	C-340	8' x 3/4" Copper Tube	139.52
172025	105004030	C-440	3' x 1" Copper Tube	52.32
116700	105004040	C-440	4' x 1" Copper Tube	75.70
143485	105004050	C-440	5' x 1" Copper Tube	94.62
116699	105004060	C-440	6' x 1" Copper Tube	113.55
142270	105004070	C-440	7' x 1" Copper Tube	132.47
116701	105004080	C-440	8' x 1" Copper Tube	151.40
182992	105001030	C-540	3' x 1-1/4" Copper Tube	64.02
45606	105001040	C-540	4' x 1-1/4" Copper Tube	85.36
35776	105001050	C-540	5' x 1-1/4" Copper Tube	106.69
35777	105001060	C-540	6' x 1-1/4" Copper Tube	128.03



## Baseboard Heat

### Elements (Continued)

#### C Series Copper with Aluminum Fin Elements

Part #	Mfg #	Model	Description	Price
44128	105001070	C-540	7' x 1-1/4" Copper Tube	149.37
45607	105001080	C-540	8' x 1-1/4" Copper Tube	170.71

#### S-532 Steel Elements Only

- 4-1/4" x 4-1/4" x 0.24"
- 32 Fins per foot
- Active element length:  
5-1/4" less than total length

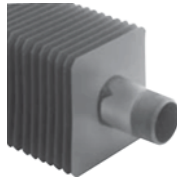

Part #	Mfg #	Model	Description	Price
51191	106001030	S-532	3' x 1-1/4" IPS Steel	54.26
75419	106001040	S-532	4' x 1-1/4" IPS Steel	72.34
75418	106001050	S-532	5' x 1-1/4" IPS Steel	90.43
49441	106001060	S-532	6' x 1-1/4" IPS Steel	108.51
75417	106001070	S-532	7' x 1-1/4" IPS Steel	126.59
49442	106001080	S-532	8' x 1-1/4" IPS Steel	144.68

### Expansion Couplings

#### Hydro/Tite Full Expansion Couplings

- Telescoping action absorbs at least 2" of expansion
- Fits easily within baseboard covers
- Piston-slide design permits unit to be rotated fully in either direction to prevent alignment problems



Part #	Mfg #	Model	Description	Price
229012	116-002	75	3/4" C x C	31.40
190146	116-003	100	1" C x C	40.09
156349	116-004	125	1-1/4" C x C	54.46

# STORE HOURS

Monday - Friday  
6AM - 4:30PM

Heating



## Baseboard Heat



### Ratings

Model	Tube Size / Material	Fin Size / Material	Fins per Foot	No. of Tiers 7"cl	Stream 1PSI* Btuh/Hr. Per Foot	Hot Water Ratings* BTUH/HR./FT. (Flow Rate 3 Ft./Sec.)								
						220° F 104° C	210° F 99° C	200° F 93° C	190° F 88° C	180° F 82° C	170° F 77° C	160° F 71° C	150° F 66° C	
<b>S-532</b>	1-1/4" IPS Steel	4-1/4" x 4-1/4" x.024" electro-gal. steel	32	1	1340	1407	1273	1152	1045	925	817	710	603	
					2	2410	2531	2290	2073	1880	1663	1470	1277	1085
					3	3170	3329	3012	2726	2473	2187	1934	1680	1427
<b>S-540</b>	1-1/4" IPS Steel	4-1/4" x 4-1/4" x.024" electro-gal. steel	40	1	1490	1565	1416	1281	1162	1028	909	790	671	
					2	2530	2657	2404	2176	1973	1746	1543	1341	1139
					3	3220	3381	3059	2769	2512	2222	1964	1707	1449
<b>S-832</b>	2" IPS Steel	4-1/4" x 4-1/4" x.024" electro-gal. steel	32	1	1360	1428	1292	1170	1061	938	830	721	612	
					2	2420	2541	2299	2081	1888	1670	1476	1283	1089
					3	3190	3350	3031	2743	2488	2201	1946	1691	1436
<b>C-340</b>	3/4" Copper	4-1/4" x 4-1/4" x.020" aluminum	40	1	1724	1810	1638	1482	1344	1189	1052	914	776	
					2	3033	3186	2882	2609	2366	2094	1851	1608	1366
					3	3881	4075	3687	3338	3027	2678	2367	2057	1747
<b>C-440</b>	1" Copper	4-1/4" x 4-1/4" x.020" aluminum	40	1	1830	1922	1739	1574	1427	1263	1116	970	824	
					2	3210	3371	3050	2761	2504	2215	1958	1701	1445
					3	3881	4316	3905	3535	3206	2836	2507	2178	1850
<b>C-540</b>	1-1/4" Copper	4-1/4" x 4-1/4" x.020" aluminum	40	1	1790	1880	1701	1539	1398	1235	1092	949	806	
					2	3150	3308	2993	2709	2457	2174	1922	1670	1418
					3	4030	4232	3829	3466	3143	2781	2458	2136	1814

Heating



## Heaters

### Twin-Flo III® Heaters

#### Twin-Flo III® Kickspace Kits

- Install in kickspace under cabinets, in between floor joists and other tight spaces
- Works with home hot water heating system
- Made in USA
- 5-Year warranty



K42

Part #	Mfg #	BTUH	Price
14946	K42	4,200	173.08
14947	K84	8,400	227.29
128993	K120	12,000	271.00

#### Twin-Flo III® Recessed Kits

- Recessed kits fit into wall recesses so they're ideal for narrow hallways, mud rooms, laundry areas, and other tight locations.
- The smaller Model W42 fits in between standard 16" center studs.
- Galvanized steel inner cabinet
- Cameo white baked enamel finish
- Color coordinated screw covers and beveled edges



Part #	Mfg #	Description	Price
14948	W42	Fits Between 16" Center Studs	118.30
14949	W84	Fits Between 23" Center Studs	131.43

#### Twin-Flo III® Surface Kits

- Twin-Flo Surface kits install quickly and easily — directly to a wall surface.
- Galvanized steel inner cabinet
- Cameo white baked enamel finish
- Sloped top and rounded edges



Part #	Mfg #	Description	Price
14950	F42	18-3/32" x 24"	118.30
14951	F84	22-3/32" x 24"	131.43

Heating

## Electronic Billing

Save time and get your invoices faster online, by email or fax!

Sign up today:

<http://ebilling.metpipe.com>





## Unit Heaters

### Steam/Hot Water, Horizontal Delivery Commercial & Industrial Unit Heaters

- Ideal for heating buildings with large open areas and low ceilings
- Totally-enclosed motor, 115/60/1
- Thermal overload protection
- Adjustable horizontal blades
- Top-bottom inlet/outlet piping
- Built-in fan safety guard

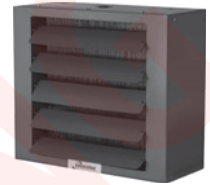

Part #	Mfg #	HP	Approx RPM	---Steam---		---Hot Water---		Entering CFM	Price
				BTUH	Final Air Temp	BTUH	Final Air Temp		
38732	HSB24-01	1/25	1550	24,000	119°F	16,200	100°F	370	569.93
36939	HSB33-01	1/25	1550	33,000	108°F	21,700	91°F	630	656.08
36144	HSB47-01	1/12	1550	47,000	119°F	30,900	98°F	730	766.85
36145	HSB63-01	1/12	1550	63,000	111°F	45,8600	97°F	1120	839.75
41842	HSB86-01	1/8	1625	86,000	118°F	60,200	101°F	1340	910.75

Heating



## Join our e-mail newsletter!

Receive special deals and promotions, new product announcements, contests and more in your inbox every month!



## Gauges & Thermometers

### Pressure Gauges Utility Service Gauges

- Accuracy: 3-2-3% ANSI B40.1 Grade B
- Black finished C.R.S. case
- Chrome plated ring
- Acrylic lens
- Brass movement
- Brass bourdon tube



Part #	Mfg #	Size	Connection	Pressure Range	Price
237501	P2508L-02	2-1/2"	1/4" NPT Bottom	0 to 15 psi	9.90
237502	P2508L-03	2-1/2"	1/4" NPT Bottom	0 to 30 psi	9.90
237503	P2508L-04	2-1/2"	1/4" NPT Bottom	0 to 60 psi	9.90
237505	P2508L-05	2-1/2"	1/4" NPT Bottom	0 to 100 psi	9.90
237506	P2508L-06	2-1/2"	1/4" NPT Bottom	0 to 160 psi	9.90
237512	P2508L-07	2-1/2"	1/4" NPT Bottom	0 to 200 psi	9.90
237509	P2508L-08	2-1/2"	1/4" NPT Bottom	0 to 300 psi	9.90
237513	P2508-03	2-1/2"	1/4" NPT Back	0 to 30 psi	9.90
237514	P2508-04	2-1/2"	1/4" NPT Back	0 to 60 psi	9.90
237515	P2508-05	2-1/2"	1/4" NPT Back	0 to 100 psi	9.90
237516	P2508-06	2-1/2"	1/4" NPT Back	0 to 160 psi	9.90
237517	P2508-07	2-1/2"	1/4" NPT Back	0 to 200 psi	9.90
237520	P3508L-02	3-1/2"	1/4" NPT Bottom	0 to 15 psi	17.81
237651	P3508L-03	3-1/2"	1/4" NPT Bottom	0 to 30 psi	17.81
237521	P3508L-04	3-1/2"	1/4" NPT Bottom	0 to 60 psi	17.81
237522	P3508L-05	3-1/2"	1/4" NPT Bottom	0 to 100 psi	17.81
237524	P3508L-06	3-1/2"	1/4" NPT Bottom	0 to 160 psi	17.81
237525	P3508L-07	3-1/2"	1/4" NPT Bottom	0 to 200 psi	17.81
237527	P3508L-08	3-1/2"	1/4" NPT Bottom	0 to 300 psi	17.81
242117	P3508L-10	3-1/2"	1/4" NPT Bottom	0 to 600 psi	17.81

### Vacuum & Compound Gauges

Part #	Mfg #	Size	Connection	Pressure Range	Price
237518	P3508L-001	3-1/2"	1/4" NPT Bottom	30"hg - 0 psi	17.81
237499	P2508L-001	2-1/2"	1/4" NPT Bottom	30"hg - 0 psi	9.90
237500	P2508L-003	2-1/2"	1/4" NPT Bottom	30" - 0 - 30 psi	9.90
237519	P3508L-003	3-1/2"	1/4" NPT Bottom	30" - 0 - 30 psi	17.81

### Severe Service - Liquid Filled Gauges

- Accuracy: 3-2-3% ANSI B40.1 Grade B
- Stainless steel case
- Stainless steel ring
- Acrylic lens
- Brass movement with precision milled teeth
- Brass bourdon tube



Part #	Mfg #	Size	Connection	Pressure Range	Price
237589	PLF2598L-03	2-1/2"	1/4" NPT Bottom w/Choke Screw	0 to 30 psi	19.79
237542	PLF2598L-04	2-1/2"	1/4" NPT Bottom w/Choke Screw	0 to 60 psi	19.79

Prices & specifications are subject to change.

Heating



## Gauges & Thermometers



### Pressure Gauges (Continued) Severe Service - Liquid Filled Gauges

Part #	Mfg #	Size	Connection	Pressure Range	Price
237590	PLF2598L-05	2-1/2"	1/4" NPT Bottom w/Choke Screw	0 to 100 psi	19.79
237592	PLF2598L-06	2-1/2"	1/4" NPT Bottom w/Choke Screw	0 to 160 psi	19.79
237594	PLF2598L-07	2-1/2"	1/4" NPT Bottom w/Choke Screw	0 to 200 psi	19.79
237595	PLF2598L-08	2-1/2"	1/4" NPT Bottom w/Choke Screw	0 to 300 psi	19.79

### Contractor's Series Gauges

- Accuracy: +1% of total range span
- Brightly finished stainless steel case
- Stainless steel ring
- Acrylic lens
- Brass movement with milled teeth
- Phosphor bronze bourdon tube
- No flange



Part #	Mfg #	Size	Connection	Pressure Range	Price
237604	P4598L-03	4-1/2"	1/4" NPT Bottom	0 to 30 psi	25.91
237609	P4598L-04	4-1/2"	1/4" NPT Bottom	0 to 60 psi	25.91
237610	P4598L-05	4-1/2"	1/4" NPT Bottom	0 to 100 psi	25.91
237611	P4598L-06	4-1/2"	1/4" NPT Bottom	0 to 160 psi	25.91

### Low Pressure Diaphragm & Water Column Gauges

- Accuracy: +1.5% full scale
- Black finished C.R.S case
- Poly carbonate lens
- Precision milled brass movement
- Beryllium copper diaphragm
- Ambient temperature: -40° to 160°F



Part #	Mfg #	Type	Connection	Pressure Range	Graduations Figure / Division	Price
822387	LP2507L-220	Water Column	1/4" NPT Lower	0 to 30" H <sub>2</sub> O	5 / .5	41.46
233822	LP2507L-300	Water Column	1/4" NPT Lower	0 to 5 psi	1 / .1	41.46

### Pressure Gauge Accessories Valves

- Operating pressure up to 2000 psi
- Teflon® packing glands
- A coil siphon should be used between needle valve and steam service



Part #	Mfg #	Description	Price
237612	1100	1/4" NPT Brass Needle Valve	9.90

Heating



## Gauges & Thermometers

### Snubbers

- Use with pressure gauge to dampen pressure pulsations
- Can be piped together in pairs for certain applications where severe pulsations exist
- Porous stone



Part #	Mfg #	Description	Price
237596	1200	1/4" NPT Brass Snubber	5.94

### Thermometers

#### Industrial Contractors Thermometers

- Accuracy: +1 scale division
- Rigid gray ABS plastic case
- Glass lens
- V-shaped scale
- Red spirit filled tube
- Brass stem
- 1/2" NPT Brass separable thermowell



S551S S551A

Part #	Mfg #	Size	Style	Scale Divisions	Temp Range	Price
237331	S551S	5"	Straight Form	5°F & 2°C	30° to 240°F	25.68
237333	S551A	5"	Angle Form	5°F & 2°C	30° to 240°F	25.68

#### Industrial Adjustable Angle Thermometers

- Accuracy: +1 scale division
- Die cast aluminum case
- Poly carbonate glass lens
- V-shaped scale
- Green organic spirit-filled glass tube
- 180° Vertical plane, 360° horizontal plane adjustable fitting



Part #	Mfg #	Use Well #	Scale Size	Stem Length	Graduations Major / Minor	Temperature Range	Price
236094	SX735-50	W35	7"	3-1/2"	10° / 2°	30° to 240°F	57.47
233810	SX935-35	W35	9"	3-1/2"	5° / 1°	0° to 120°F	50.88
233808	SX935-50	W35	9"	3-1/2"	10° / 2°	30° to 240°F	50.88
233811	SX935-60	W35	9"	3-1/2"	10° / 2°	30° to 300°F	50.88
233809	SX935-75	W35	9"	3-1/2"	10° / 2°	0° to 160°F	50.88
233812	SX935-77	W35	9"	3-1/2"	10° / 2°	30° to 180°F	50.88
237335	SX960-50	W60	9"	6"	10° / 2°	30° to 240°F	66.19
237337	SX960-75	W60	9"	6"	10° / 2°	0° to 160°F	66.19





## Gauges & Thermometers



### Industrial Solar Digital Thermometer

- Accuracy: greater value of 1° or 1% of reading
- ABS Black plastic case
- Aluminum stem
- Glass passivated thermistor
- Sensor LCD display
- Bi-directional solar collectors



Part #	Mfg #	Use Well #	Stem Length	Connection	Temperature Range	Price
233829	CDX935-85	W35	3-1/2"	1-1/4" - 18 UNEF Brass Jam Nut	-58° to 302°F	70.43

### Bi-Metal Dial Thermometers

- Accuracy: +1 scale division
- Hermetically sealed 300 series stainless steel case and ring
- Double strength glass lens



Part #	Mfg #	Use Well #	Dial Diameter	Stem Length	Connection	Temp Range	Price
237339	B3099-54-2	BW02B	3"	2-1/2"	1/2" NPT Rear	0° to 250°F	38.63
237340	B3099-39-2	BW02B	3"	2-1/2"	1/2" NPT Rear	-40° to 160°F	38.63
237343	B5099-54-2	BW02B	5"	2-1/2"	1/2" NPT Rear	0° to 250°F	65.95

### Bi-Metal Pocket Thermometers

- Stainless steel case
- Raised clear acrylic magnifying lens
- Plastic carrying case with pocket clip included



Part #	Mfg #	Dial Diameter	Stem Length	Temperature Range	Price
236089	B1098M82C-5.0	1"	5"	0° to 220°F	8.47
877416	B1098M90C-5.0	1"	5"	-40° to 160°F	8.47

### LCD Digital Pocket Thermometer

- Digital readings to 1/10 of a degree
- Reading update in one second intervals
- On-off switch
- Stainless steel stem
- Protective pocket sheath with clip



Part #	Mfg #	Dial Diameter	Stem Length	Temperature Range	Price
873285	CD1098122	1-1/4"	5"	-58° to 302°F	21.66

### Thermowells

- Companion 3/4" NPT separable socket



Part #	Mfg #	Stem Length	Immersion Length	Material	Use with	Price
236097	W35B	3-1/2"	2-1/2"	Brass	Industrial Thermometers	10.60
237345	W60B	6"	5"	Brass	Industrial Thermometers	22.61
237344	BW02B	2-1/2"	1-5/8"	Brass	Bi-Metal Thermometers	31.80

Prices & specifications are subject to change.

Metropolitan Pipe offers Vendor Managed Inventory - never run out of that part again!



## Gauges & Thermometers

### Water Test Gauges

- Steel case with 2-1/2" shatter-proof face
- Individually boxed
- 3/4" Brass hose connection



Part #	Mfg #	Description	Price
18261	J66-300	300 psi Water Test Gauge	12.07



### Gauges & Instrumentation

#### W-R Tridicators

- 70° to 250°F
- 55 psi
- 3-1/4" Face



Part #	Mfg #	Size	Type	PSI Range	Temperature Range	Price
15232	1711009	1/2" NPT	Straight	0 - 55 PSI	70° - 250°	48.32
15233	1711011	1/2" NPT	Angle	0 - 55 PSI	70° - 250°	30.00
15234	1711018	1/4" NPT	Long Shank Angle	0 - 70 PSI	60° - 260°	19.68

### Steam Siphons (Pigtails)



Straight Angle  
**1/4" IPS Black Iron**

Part #	Mfg #	Description	Price
15329	1706002	Straight	4.11
15330	1706004	Angle	4.11

### 1/4" IPS Brass

Part #	Mfg #	Description	Price
15331	1706006	Straight	9.79
15332	1706008	Angle	9.79



**FREE Local Delivery**

Heating



# Thermostats



## Thermostats

### T87 Non-Programmable The Round®

- Premier White®
- Classic twist dial - mercury free
- Relay switch type, battery assisted power stealing
- Provides electronic control of 24VAC heating and cooling systems
- Electrical ratings: 18 to 30VAC
- Setting temperature range: 40°F to 90°F
- Dimensions: 3-11/16" diameter x 1-3/4" deep



Part #	Mfg #	Description	Price
872077	T87K1007	1 Heat	36.07
872078	T87N1000	1 Heat/1 Cool	52.79

### PRO 5-2 Programmable Thermostat

- Weekday/Weekend programming 5-2 (Weekdays, Weekend) program.
- Backlit digital display - both current and set temperatures are easy to read in various lighting conditions.
- Precise comfort control [+/- 1 F (+/- 0.5 C)] - maintains consistent comfort to the highest level of accuracy.
- Basic operation - easy-to-use slide switches allow you to select the heat or cool mode, and operate the fan.
- Built in instructions - simple, pull out instruction manual.
- Adaptive Intelligent Recovery™ - ensures programmed temperature is reached by programmed time.



Part #	Mfg #	Description	Price
938783	TH4110D1007	Programmable H/C	47.23

### T651A Commercial Light Duty Line Voltage

- Control line voltage on valves, motors, contacts, electric heat elements, duct furnaces, and fan coil units in heating/cooling systems
- Automatic cooling and heating anticipation
- With SPDT switch & thermometer
- 35° - 95°F Setpoint
- Includes faceplate, horizontal or vertical



Part #	Mfg #	Description	Price
229249	T651A3018	Heat/Cool, Lockout Cover & Range Stops	71.44

## Pressuretrol® Pressure & Limit Controllers

### L91 Modulating Proportional Pressuretrol® Controllers

- For regulation of liquid or air & other non-corrosive gases
- May be used with steam, air, non-combustible gases, or other fluids non corrosive to brass or phos-bronze (300 psi model) bellows
- Adjustments made with screws on case top
- Surface mount with screws through knockout holes in case back
- When used with steam boilers, a siphon loop is recommended (14026)
- Single potentiometer 140 ohms



Part #	Mfg #	Description	Price
49368	L91B1035	0 to 15 psi Operating Range	336.00

### L4079 Pressuretrol® Limit Controllers

- Use with steam, air, noncombustible gases, and fluids non-corrosive to stainless steel
- Mounts using 1/4" FNPT or surface mount through base of case
- Includes siphon loop
- Manual reset
- Operating range: 2 to 15 psi



Part #	Mfg #	Description	Price
880921	L4079B1033	SPST Break on Rise	126.38

### PA404A Pressuretrol® Controller

- Safety control for steam heating boilers, breaks an electrical circuit to shut down burner if steam pressure rises above safe level
- Makes at setpoint on pressure fall, breaks at setpoint plus differential on pressure rise
- Operating range: 0.5 to 9.0 psi



Part #	Mfg #	Description	Price
15441	PA404A1033	SPST, 1 to 5 psi Differential	146.24

Heating



## Controls & Regulators



### Power Generators

#### Q313 Replacement Thermopile Generators

- 600-750mV Replacement thermopile generator
- Provides power for a milli-voltage, self-powered control system
- Includes spade terminals
- Use with Q314, Q324, Q327, Q377, Q379 & Q382 pilot burners



Part #	Mfg #	Description	Price
49886	Q313A1170	35" Lead, PG9 Adapter	54.03

### Thermocouples

#### Q340 Thermocouples

- 30mV Replacement thermocouple



Part #	Mfg #	Description	Price
15452	Q340A1066	18" Lead	8.83
15453	Q340A1074	24" Lead	9.35

#### Q390 Thermocouples Overpack

- Individual shrink packs

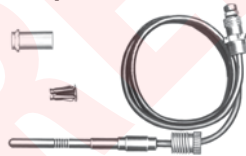

Part #	Mfg #	Description	Price
93003	Q390A1061	36" Lead, Carded	6.16

### Hydronic Switching Relays

- Provides intermediate switching of line voltage device from low voltage controller
- Integral transformer provides low voltage power for control circuit
- Color-coded lead wires for easier wiring
- 120V, 50/60Hz



Part #	Mfg #	Description	Price
15444	RA832A1066	DPST Enclosed 2-Wire for 2-Line Voltage Loads	76.55

### R8845U Universal Switching Relay

- The R8845U Universal Switching Relay with 24 V transformer provides intermediate switching of line- and low-voltage devices from a line- or low-voltage controller and is typically applied in Hydronic heating systems.
- Replaceable socketed relays.
- Two troubleshooting LED.
- Push-to-test button.
- Replaceable transformer fuse.
- Low-voltage contact rating for Powerpile applications.
- Long-life DC relay drive control technology.
- Relay for use with external 24 Vac or 24 Vdc supply, with line-voltage control, or with internal 24 V transformer supply.



Part #	Mfg #	Description	Price
860799	R8845U-1003	120V, 60 Hz Universal Switching Relay with internal transformer	72.15

### Remote Temperature Controls

#### T991A Modulating Remote Bulb Temperature Controller

- For modulating control of water or air temperature in ducts, tanks & similar applications
- 5' Copper, potentiometer 130 ohms



Part #	Mfg #	Description	Price
36761	T991A1061	160 - 260°F Range	218.00

Heating



## Controls & Regulators



### Primary Controls

#### R7284U Electronic Oil Primary Control

- The R7284B,P,U,G Electronic Oil Primary is a line voltage, safety rated, interrupted and intermittent ignition oil primary control for residential oil fired burners used in boilers, forced air furnaces and water heaters.
- The R7284B,P,U,G used with a cad cell flame sensor operates an oil burner, spark igniter, and optional oil valve.
- The control works with a low voltage and optional high voltage thermostat.
- The primary controls fuel oil, senses flame, controls ignition spark (either interrupted or intermittent) and notifies through the EnviraCOM™ bus a remote alarm circuit when in lockout.



Part #	Mfg #	Description	Price
945335	R7284U-1004	Electronic Oil Primary with 15 seconds lock out timing and selectable valve and blower delays	79.74

### Aquastats®

- Immersion type controllers for limiting or regulating temperatures of liquids in boilers or tanks
- Totally enclosed Micro Switch™
- Visible control point scale
- External adjustment screw
- Horizontal or vertical insertion of sensing element
- Direct or well immersion of sensing element

#### L4006A Immersion Type High or Low Limit - SPST Breaks Circuit on Temperature Rise

- Stop factory set at 240°F; operating range: 100° to 240°F
- 1-1/2" Insulation



Part #	Mfg #	Description	Price
15446	L4006A1967	Horizontal or Vertical Mount	112.18

#### L4006E Immersion Type High Limit - SPST Breaks Circuit on Temperature Rise

- Manual Reset
- Stop factory-set at 250°F, operating range: 130° to 270°F
- 3" Insulation



Part #	Mfg #	Description	Price
44793	L4006E-1000	Horizontal or Vertical Mount	118.00

#### L6006A Immersion Type, Circulator Control & High Limit or Low Limit, SPDT

- Stop factory set at 240°F; operating range: 100° to 240°F
- 3" Insulation
- Includes heat conductive compound



Part #	Mfg #	Description	Price
15449	L6006A1145	Horizontal Mount	114.53

#### L6006C Strap-On Mount, Circulator Control & High Limit & Low Limit, SPDT

- Operating range: 60° - 200°F



Part #	Mfg #	Description	Price
15451	L6006C1018	Horizontal or Vertical Mount	106.21

#### L7224U Oil Electronic Aquastat® Controller

- 120 Vac Oil Electronic Aquastat® Controller with EnviraCom communication and troubleshooting Leds
- Operating Range
  - Low Limit (F) 110 F to 220 F
  - High Limit (F) 130 F to 240 F
- Well mount, horizontal or vertical position, or flush mounted remote from the well.



Part #	Mfg #	Description	Price
908236	L7224U-1002	120 Vac Oil Electronic Aquastat® Controller	177.06

Heating



## Controls & Regulators



### Well Assemblies for Aquastats & Remote Bulb Controllers

3/8" x 3" Copper Bulb Size -  
 3" Well Size

- Includes mounting clamp



Part #	Mfg #	Description	Price
37397	121371A	1/2" x 1-1/2" Insertion	26.81
48411	121371B	3/4" x 1-1/2" Insertion	30.53
46922	121371M	3/4" x 3" Insertion	39.63

### Transformers

#### AT72 NEMA Standard Transformers

- 24V control circuit step-down transformer designed to power any 24V control system, including thermostats, gas valves and relays
- NEMA Type D, meets NEC Class 2 Not Wet, Class 3 Wet & UL 1585 requirements
- 9" Lead wires (primary)
- (2) Screw terminals
- 40VA Output, 120V primary voltage @ 50/60Hz

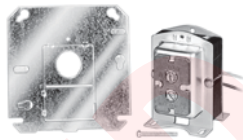

Part #	Mfg #	Description	Price
15438	AT72D1006	120V, 4" x 4" Plate Mount	28.92

### Ignition Controllers

#### One or Two Rod Intermittent Pilot Control

- Provides ignition sequence, flame monitoring and safety shutoff for intermittent pilot central furnaces and heating appliances.
- For use in single rod or dual rod/remote sense applications.
- Includes relay contacts for use with any intermittent pilot gas control string with maximum 1.0A pilot or 2.0A main valve rating.
- Includes spark cable adapters to allow field replacement of both Honeywell and competitive controls without replacing existing spark cable.



Part #	Mfg #	Description	Price
884884	S8610U-3009	One or Two Rod Intermittent Pilot Control with continuous retry trial time	143.26

#### One or Two Rod Hot Surface Ignition Control

- Module provides operating control of a direct ignition system using a 120 Vac hot surface igniter.
- For 120 Vac (up to 5.0A) surface igniter.
- For local (single rod) or remote (dual rod) rectification type flame sensing.
- Temperature range is -40 to +175 F (-40 to +79 C).



Part #	Mfg #	Description	Price
172382	S8910U-1000	One or Two Rod Hot Surface Ignition Control	145.33

### Gas Valves

#### Honeywell VR8300A 24 Vac Dual Standing Pilot Gas Valve

- Combination gas control for use in 24 Vac, gas-fired, standing pilot appliances with capacities from 30 to 300 cfh.
- Safety shutoff, manual valve, two automatic operators, pressure regulator and pilot adjustment.
- Two automatic valves.
- Solenoid operated first automatic valve opens on thermostat call for heat; closes when call for heat ends.
- Diaphragm-operated second automatic valve opens under control of regulator; closes if gas or power supply is interrupted.



Part #	Mfg #	Description	Price
210351	VR8300A-4516	3/4" 24 Vac Dual Standing Pilot Gas Valve	124.08



## Controls & Regulators



### VR8345M4302 Dual Direct Ignition / Intermittent Pilot Gas Valve

- Universal electronic ignition combination gas control for use with direct spark ignition, hot surface ignition or intermittent pilot ignition in 24 Vac, gas-fired appliances, with capacities from 30 to 415 cfh.
- Control includes manual valve, two automatic operators, pressure regulator, pilot adjustment, pilot plug and ignition adapter.
- Replaces virtually any IP, HSI, or DSI gas control.
- For use with natural or manufactured gas or LP gas.
- All adjustments and wiring connections accessible from top of control.
- Four-inch swing radius allows easy rotation into position inside the tightest furnace vestibules.
- Clearly marked, keyed terminal block allows quick attachment of wires and IP/DSI/HSI jumper.
- Internal inlet screen blocks contaminants in gas line from entering valve.



Part #	Mfg #	Description	Price
160452	VR8345M4302	3/4" 24 Vac Dual Direct Ignition/Intermittent pilot Gas Valve	129.61

### Zone Valves

#### V8043F Series CXC Zone Valves

- Two-way on-off low voltage valves consist of an actuator and valve assembly for controlling the flow of hot water.
- Manual opener (on all models, except straight-through, normally open valves) for valve operation on power failure; valve returns to automatic position when power is restored.
- May be installed without disassembling the valve.
- Compact construction for easy installation.
- Complete powerhead may be removed or replaced without breaking plumbing line connections or draining the system.
- Actuator motor may be replaced without removing the valve body or draining the system.



Part #	Mfg #	Size	Price
42388	V8043F-1036	3/4"	106.14
145514	V8043F-1051	1"	117.35

### POWERS A WATTS INDUSTRIES CO.

#### #11 Self-Operating Temperature Regulators

#### Valves & Operators Sold Separately

##### CD-Type Regulators - Single Seat

- Bronze body ANSI 250#
- Bronze trim with composition shutoff disc
- Spring-loaded V-ring Teflon® packing



Part #	Mfg #	Size	Valve Action	Price
15701	590-CD075H	3/4" Union	Heating	787.48
15702	590-CD100H	1" Union	Heating	966.05
15703	590-CD125H	1-1/4" Union	Heating	1125.11
15704	590-CD150H	1-1/2" Union	Heating	1300.75

##### ST-Type Regulators - Single Seat

- Bronze body ANSI 250#
- Stainless steel trim
- Spring-loaded V-ring packing

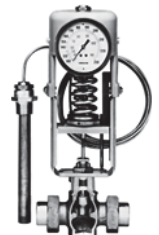

Part #	Mfg #	Size	Valve Action	Price
15705	590-ST050H	1/2" Union	Heating	807.97
15706	590-ST075H	3/4" Union	Heating	846.03
15707	590-ST100H	1" Union	Heating	1057.78
15708	590-ST050C	1/2" Union	Cooling	807.97
15709	590-ST075C	3/4" Union	Cooling	846.03
15710	590-ST100C	1" Union	Cooling	1057.78

##### DS-Type Regulator - Double Seat

- Bronze body ANSI 250#
- Stainless steel trim (use with inlet pressure above 50 psi)
- Spring-loaded V-ring packing



Part #	Mfg #	Size	Valve Action	Price
15714	590-DS200H	2" Union	Heating	2703.96
15711	590-DS100H	1" Union	Heating	1543.73
15712	590-DS125H	1-1/4" Union	Heating	1683.27
15713	590-DS150H	1-1/2" Union	Heating	1996.50

Heating



## Controls

### WM-Type Regulators - Water Mix 3-Way

- Bronze body ANSI 125#
- Bronze trim with EPT discs
- EPT Spring-loaded V-ring packing



Part #	Mfg #	Size	Valve Action	Price
15716	590-WM100M	1" FNPT	Mixing	975.81
15717	590-WM125M	1-1/4" FNPT	Mixing	1136.82
15718	590-WM150M	1-1/2" FNPT	Mixing	1313.44
15719	590-WM200M	2" FNPT	Mixing	1750.60

### Accritem® Rigid Bulb Temperature Controller

- (2) Pressure gauges
- 1/2" NPT Pipe fittings
- Bimetallic sensing element
- Adjustable set point: 50° to 350°F
- Maximum operating pressure: 250 psi
- Maximum operating temperature: 400°F



#### Rigid Copper Bulb

Part #	Mfg #	Description	Price
15734	7441214	Air Operated, Reverse Action	732.84

### #11 Sensing Bulbs and Protective Wells

#### Style D - Fixed Union Bulbs

- For rigid, pressure-tight attachment to vessel or pipeline - either directly or into socket well
- Non-Indicating head assembly
- Copper bulb and capillary
- Pressure ratings
  - Non-shock: 250 psi
  - Shock: 175 psi

#### 1" x 20" Bulb with 8' Capillary

Part #	Mfg #	Cooling D.A.(°F)	Heating R.A.(°F)	Water Mix(°F)	Price
15722	700-C08DN03	85-145	70-130	80-140	804.07
15723	700-C08DN04	-	90-150	100-160	804.07

#### 1" x 9" Bulb with 8' Capillary

Part #	Mfg #	Cooling D.A.(°F)	Heating R.A.(°F)	Water Mix(°F)	Price
15724	700-C08DN05	110-170	110-150	110-160	804.07
15726	700-C08DN07	140-200	120-180	135-195	804.07

#### Style S - Bulb Wells

- For sealing style D bulb in tanks or pipeline installation

Part #	Mfg #	Description	Price
15732	709-193	1" x 9" Chrome-Plated Copper	126.86
15730	709-075	1" x 20" Chrome-Plated Copper	179.55



### Pilot

#### Type E - Main Valves PRESSURES to 600 PSIG at 750°F

- Normally closed
- Single seat
- Balanced metal diaphragms
- Protected main spring
- Fluid, gas & vapor applications
- Multiple trims for precise sizing
- ANSI/FCI 70-2 class IV shutoff
- Virtually frictionless for long service life
- Packless construction
- Easy in-line maintenance
- Wide variety of pilots for many applications
- Minimum operating p 10 psi (.7 bar)
- Lifetime warranty against wire drawing of seat & disc

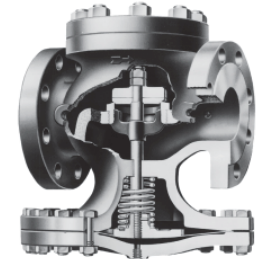

Part #	Mfg #	Description	Price
886579	07-13018-00	1/2" NPT	606.00
15974	07-11997-00	3/4" NPT	657.00
15975	07-13019-00	1" NPT	723.00
15976	07-11998-00	1-1/4" NPT	918.00
15977	07-13020-00	1-1/2" NPT	1119.00
15978	07-11999-00	2" NPT	1477.00
15979	07-13000-00	2-1/2" Flange	2192.00
15980	07-13001-00	3" Flange	2797.00
876172	07-13002-00	4" Flange	85.50

Heating





# Steam Regulators



## Type E2 - Main Valve LOW PRESSURE- LOW DIFFERENTIAL PRESSURES to 15 PSIG at 250°F

- Normally closed
- Single seat
- Hycar diaphragm
- Protected main spring
- Gas & steam applications
- Accurate regulation unaffected by service conditions
- ANSI/FCI 70-2 class IV shutoff
- Virtually frictionless for long service life
- Packless construction
- Easy in-line maintenance
- Wide variety of pilots for many applications
- Minimum operating  $\Delta P$  3 psi (.2 bar)
- Lifetime warranty against wire drawing of seat & disc

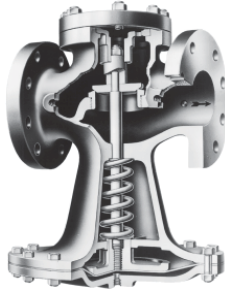

Part #	Mfg #	Description	Price
166641	07-13008-00	3/4" NPT	752.00
120085	07-13021-00	1" NPT	860.00
189013	07-13022-00	1-1/4" NPT	966.00
49426	07-13009-00	1-1/2" NPT	1101.00
137096	07-13010-00	2" NPT	1451.00

## Type D - Pressure Reducing Pilot

- Self contained
- Spring operated
- Normally closed
- Packless construction
- Fluid, gas & vapor applications
- Type D for +/- 1 psig control of delivery pressure between 3 and 150 psig
- Type D5 for +/- 1/2 psig control of delivery pressure between 1 and 25 psig
- Cast Iron or Cast Steel construction

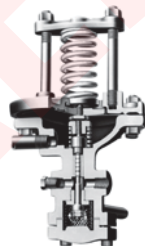

Part #	Mfg #	PSIG	Material	Color	Price
15981	D-Pilot	3-20	Iron	Aluminum	424.00
15982	D-Pilot	5-50	Iron	Orange	424.00
15983	D-Pilot	10-100	Iron	Green	424.00
15984	D-Pilot	20-150	Iron	Black	424.00
15987	D-Pilot	10-100	Steel	Green	1434.00
176676	D5-Pilot	1-10	Iron	Aluminum	645.00

## Type A - Air Adjusted Pilot

- Air loaded
- Remote control
- Spring operated
- Normally closed
- Packless construction
- Fluid, gas & vapor applications
- Accurate to +/- 1 psig



Part #	Mfg #	Pressure	Material	Price
15993	A-Pilot	1-1 psig	Cast Iron	422.00

## Type M - Solenoid Pilot

- Fast acting for quick response
- 2-Way normally closed for steam and other hot fluid services in multiple pilot arrangements



Part #	Mfg #	Pressure	Temp	Price
16061	M33H	250 psig	406°F	1520.53

## Type D208 - Electronic Actuator Pilot with Electronic Time Controller

- Controlled incremental positioning of main valve
- Electronic time controller opens/closes valve in up to 96 minutes
- For use with balanced main valve only



Part #	Mfg #	Temp Range	Material	Price
38204	D-208	20°-120°F	Cast Iron	4545.00

## Type T14 - Vapor Tension Temperature Pilot

- Precise, rapid response
- Spring operated
- Self contained
- Normally open, direct operating
- Packless construction
- Fluid, gas and vapor application



Part #	Mfg #	Temp Range	Material	Price
16001	T14	70°-170°F	Cast Iron	988.00
16002	T14	120°-220°F	Cast Iron	988.00
53245	T14	Pilot with 704 Bulb Integral		1287.00

Heating

Prices & specifications are subject to change.



## Steam Regulators



### Type T61 - Pneumatic Temperature Controller

- Bimetallic thermostat
- 200°F Adjustable temperature range
- Air consumption maximum: .7
- Over temperature protection
- Air supply pressure 30 psi



Part #	Mfg #	Temp Range	Material	Price
15996	T61	50°-250°F	Bronze	711.00

### Type T124 - Temperature/Pressure Pilot

- Precise, rapid response
- Vapor tension thermostat spring operated
- Self contained
- Normally open
- Packless construction
- Fluid, gas and vapor applications
- For heater operating pressure between 20 and 125 psig



Part #	Mfg #	Temp Range	Material	Price
15999	T124	70°-170°F	Cast Iron	1195.00
16000	T124-120	120°-220°F	Cast Iron	1195.00

### Type T134 - Temperature/Pressure Pilot

- Precise, rapid response
- Vapor tension thermostat spring operated
- Self contained
- Normally open
- Packless construction
- Fluid, gas and vapor applications
- For heater operating pressures up to 20 psig



Part #	Mfg #	Temp Range	Material	Price
15997	T134	70°-170°F	Cast Iron	1233.00
15998	T134	120°-220°F	Cast Iron	1233.00

### Thermostat Bulbs

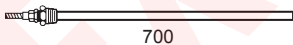

700



704

Part #	Mfg #	Description	Price
15994	700	70°-170°F, Plain Bulb with 1" Union Connection	496.00
15995	700	120°-220°F, Plain Bulb with 1" Union Connection	496.00
16005	704	70°-170°F, Plain Short Bulb with 1-1/4" Union Connection	654.00

### Thermostat Wells



Part #	Mfg #	Description	Price
16006	728	Used with 700 & 800 Bulb	188.00



### Pressure and Temperature Controls

#### GD-30 Series - Direct-Acting Pressure Reducing Valves - Bronze

- For steam, air and non-corrosive gasses
- Compact, high-performance
- Ideal for low to moderate flow applications
- Provides tight shutoff for dead-end service on steam
- Inlet pressure: 15 to 250 psig
- Minimum differential: 7 psig
- Maximum temperature: 410°F



Part #	Mfg #	Pipe Connection	Reduced Pressure	Price
40050	GD-30	1/2"	3 - 15 psig	461.00
163777	GD-30	1/2"	7 - 60 psig	461.00
882518	GD-30	3/4"	3 - 15 psig	497.00
242103	GD-30	3/4"	7 - 60 psig	497.00



### Steam Pressure Regulators

#### 152A Series Steam Pressure Reducing Valves

- For autoclaves, steam tables/irons, vulcanizers and single radiators, also sterilizers, process lines, testing fixtures and oil lines
- Highly sensitive to reduced pressure changes
- Sensitivity adjustment feature for critical flow

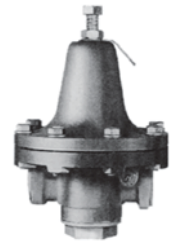

#### 152A Iron Body (FNPT Inlet and Outlet)

- Initial pressures up to 200 psi
- Stainless steel disc, seat & strainer

Part #	Mfg #	Model	Size	PSI	Price
16284	0830886	152A	1/2"	3 - 15	536.40
16285	0830910	152A	1/2"	10 - 50	536.40
16286	0830905	152A	1/2"	30 - 140	510.85
16287	0830918	152A	3/4"	3 - 15	614.90
16289	0830920	152A	3/4"	10 - 50	645.65

Prices & specifications are subject to change.



## Valves & Backflow Preventers



### Steam Pressure Regulators (Continued)

#### 152A Series Steam Pressure Reducing Valves

##### 152A Iron Body (FNPT Inlet and Outlet)

Part #	Mfg #	Model	Size	PSI	Price
16290	0830928	152A	3/4"	30 - 140	645.65
16291	0830946	152A	1"	3 - 15	842.75
16292	0830945	152A	1"	10 - 30	842.75
16293	0830950	152A	1"	30 - 140	842.75
16294	0830960	152A	1-1/4"	10 - 30	1164.25

##### Repair Kits for Series 152A

Part #	Mfg #	Model	Size	Price
16454	0875605	152ARK	3/4"	168.35
54367	0875705	152ARK	1" & 1-1/4"	210.70

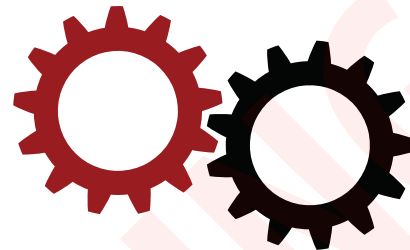

## Valve Actuation

Our in-house valve actuation shop is equipped to add actuators (both pneumatic and electric) to many different sizes and types of valves.

Heating

## Honeywell

### Thermostatic Radiator Valves

Thermostatic Radiator Valves provide individual control of radiators, convectors or baseboard heating units. They can be used to control a single unit, room or zone. Energy savings are realized because the valve automatically shuts off the flow of heat when the temperature setting is reached.

#### V110 Thermostatic Radiator Valves

- High capacity
- Provide precise and automatic temperature control in 2-pipe steam systems by modulating the flow of hot water or steam through free-standing radiators, convectors and other heating units with high capacity requirements
- Normally open without control mounted
- EPDM Valve seat disc

V110D



- Use remote actuator only

Part #	Mfg #	Body Style	Pipe Connection	Pipe Size	-----Capacity-----			Used with	Price
					Capacity	Cv	BTUH-Steam		
15108	V110D1000	Straight	Threaded	1/2"	High	4.6	127,000	T104	59.94
15109	V110D1008	Straight	Threaded	3/4"	High	5.8	162,000	T104	63.29
15110	V110D1016	Straight	Threaded	1"	High	7.0	193,000	T104	95.28
15111	V110D1024	Straight	Threaded	1-1/4"	High	8.0	193,000	T104	151.25

V110E



- Use remote actuator only

Part #	Mfg #	Body Style	Pipe Connection	Pipe Size	-----Capacity-----			Used with	Price
					Capacity	Cv	BTUH-Steam		
15104	V110E1004	Angle	Threaded	1/2"	High	4.6	127,000	T104	85.62
15105	V110E1012	Angle	Threaded	3/4"	High	5.8	162,000	T104	72.38
15106	V110E1020	Angle	Threaded	1"	High	7.0	193,000	T104	95.27
15107	V110E1028	Angle	Threaded	1-1/4"	High	8.0	193,000	T104	151.25

Prices & specifications are subject to change.

Our state of the art pipe shop offers cutting, threading, grooving and make-ons up to 36in!



**Valves**

**V110F**



- Use remote or unitary actuator

Part #	Mfg #	Body Style	Pipe Connection	Pipe Size	Capacity			Used with	Price
					Capacity	Cv	BTUH-Steam		
15112	V110F1002	Horizontal Angle	Threaded	1/2"	High	4.6	127,000	T104	77.24
15113	V110F1010	Horizontal Angle	Threaded	3/4"	High	5.8	162,000	T104	110.95
15114	V110F1018	Horizontal Angle	Threaded	1"	High	7.0	193,000	T104	113.41
15115	V110F1026	Horizontal Angle	Threaded	1-1/4"	High	8.0	193,000	T104	151.25

**Replacement Cartridge**

Part #	Mfg #	Description	Price
15124	CA110C1007	For V100, V110 Series	38.48

**V2042H One-Pipe Steam Thermostatic Radiator Valve**

- For 1-pipe steam or hot water systems for free standing radiators, convectors and other heating units with standard capacity requirements
- Continuous monitoring
- Adjustable balancing cartridge design
- Replaceable cartridge for easy service with service tool
- Controls include valve body, steam air vent
- No electrical connection required for non-electric actuators
- Normally open without control mounted



V2042H requires  
 Dole #1933 1/8in  
 Vent

Part #	Mfg #	Body Style	Pipe Connection	Pipe Size	Used with	Price
817049	V2042HSL10	Angle	Threaded	1/8"	T100	61.11

**Required Vent for V2042H**

Part #	Mfg #	Size	Type	Description	Price
15178	1933	1/8"	Straight	Steam Air Vent	55.86
15180	1933	1/8"	Angle	Steam Air Vent	33.21

**Thermostatic Valve Actuators**

**T100 Standard Capacity Thermostatic Radiator Actuators**

**T100A Horizontal Mount**



- A self-contained control with sensor, setpoint dial & valve actuator in one unit
- Not for use inside enclosures or where airflow around sensor is restricted

Part #	Mfg #	Collar Diameter	Sensor	Setpoint	Temperature Range	Comments	Price
15116	T100A1028	1-3/16"	Integral	Integral	43° to 79°F	Adj Limits, for V110 Valves	28.46

Heating



# Valves



## T104 High Capacity Thermostatic Radiator Actuators

- Precise and automatic control of room temperature in two-pipe systems
- Continually monitors and adjusts room temperature for consistent comfort and relief from under heating and overheating
- Controls include sensor, setpoint dial and valve actuator; components may be integral or connected by capillary tubes

### T104A Horizontal Mount

- A self-contained controller with sensor, setpoint dial & valve actuator in one unit
- Not for use inside enclosures or where airflow around sensor is restricted



Part #	Mfg #	Capillary	Sensor	Setpoint	Temperature Range	Comments	Price
15118	T104A1040	Integral	Integral	Integral	43° to 79°F	Adj Limits, for V110 Valves	46.92

### T104B

- A control with combined remote setpoint & sensor mounted on wall
- Connected by a capillary tube to an actuator, which is mounted on the valve body



Part #	Mfg #	Capillary Length	Sensor	Setpoint	Temperature Range	Comments	Price
15120	T104B1038	6'-8"	Remote	Remote	43° to 79°F	For V110 Valves	114.88

### T104C

- A control with remote setpoint and sensor mounted with setpoint dial on outside of heating cabinet; sensor mounted beneath heating coils in cold air return
- Double capillary



Part #	Mfg #	Capillary Length	Sensor	Setpoint	Temperature Range	Comments	Price
15122	T104C1036	(2) 4'-1/2'	Remote	Remote	43° to 79°F	For V110 Valves	153.37

### T104F

- Thermostatic radiator valve controller
- Remote temperature sensing and integral setpoint



Part #	Mfg #	Capillary Length	Sensor	Setpoint	Temperature Range	Comments	Price
15119	T104F1512	6'-8"	Integral	Integral	43 to 79° F	Adj Limits, for V110 Valves	86.95

Heating

Prices & specifications are subject to change.



**Valves**

**Thermostatic Mixing Valves**

**AM-1 Series 3-Way Thermostatic Mixing Valves**

- Adjusts, maintains and limits the hot water temperature to a desired setting selected by user
- In domestic use, offers scalding protection and bacteria growth control
- Dual purpose mixing or diverting
- Proportional valve
- Nickel-plated brass construction, EPDM O-rings



Part #	Mfg #	Pipe Size	Connection	Operating Temperature	Price
143043	AM100C-1	1/2"	NPT	80°-120°F	118.28
143885	AM101C-1	3/4"	NPT	80°-120°F	123.54
188393	AM-101C-US-1	3/4"	Union Sweat	80°-120°F	115.45
854652	AM101-1	3/4"	NPT	100°-145°F	107.96



Heating



## Thermostats



### RA2000 Thermostatic Valve Operators

- Conforms to ASHRAE/ANSI standard 102-1983
- Suitable for radiator/convector heating systems and installations
- Temperature range: 45° to 86°F

#### Valve-Mount Dial & Remote Sensor

- Sensor can be mounted on a wall up to 6' away in a draft-free location



Part #	Mfg#	Design	Capillary Tube	Price
229987	013G8252	Standard	6'	53.31

#### Wall-Mount Dial & Remote Sensor

- Combined remote mounted dial and sensor can be up to 6' away from valve
- Includes sockets for use on RAV, KOVM, and VMT valve bodies



Part #	Mfg#	Design	Capillary Tube	Price
15150	013G8562	Wall-Mount	6'	75.31

#### Remote Dial & Remote Sensor

- The remote dial mounts on the wall up to 6' away
- The sensor is mounted beneath the radiation or on a draft-free wall up to 6' away from the dial
- Includes sockets for use on RAV, KOVM, and VMT valve bodies



Part #	Mfg#	Design	Capillary Tube	Price
155712	013G8564	Wall-Mount	(2) 6'	114.24

#### Radiator Valve Operator Adapters

Part #	Mfg #	Description	Price
15146	013G8070	RA to RA2000 Adapter	47.39
38486	013G8072	RAV to RA2000 Adapter	47.39

### RA-PLUS Radiator Thermostats

#### Programmable Sensors

- Changes room temperature approximately 3°C
- Includes timer box with (2) programs
- Temperature range: 45° to 86°F



Part #	Mfg#	Description	Price
15148	013G8250	Built-In, Fits RA-2000	36.39

### RA2000 Valve Bodies

- Valves regulate the flow of hot water or steam through free-standing regulators, baseboards or convectors in hot water and 2-pipe low pressure steam systems
- Maximum working pressure: 15 psi
- Maximum water temperature: 250°F
- Conforms to ASHRAE/ANSI standard 102-1983

#### Pipe Steam with Vacuum Breaker (FNPT x MNPT)

- 1-Pipe steam with vacuum breaker



Part #	Mfg#	Size	Price
15145	013G0140	1/8"	66.00

#### Straight (FNPT x MNPT)

- For water or LP steam



Part #	Mfg#	Size	Price
15156	013G8015	1/2"	33.85
15157	013G8020	3/4"	37.24
15158	013G8025	1"	54.16
15159	013G8032	1-1/4"	93.93

#### Angle (FNPT x MNPT)

- For water or LP steam



Part #	Mfg#	Size	Price
15160	013G8014	1/2"	33.85
15161	013G8019	3/4"	37.24
15162	013G8024	1"	54.16
15163	013G8031	1-1/4"	93.93

#### Side Mount Angle (FNPT x MNPT)

- For water or LP steam



Part #	Mfg#	Size	Price
15152	013G8013	1/2"	33.85
15153	013G8018	3/4"	37.24
15154	013G8023	1"	54.16
15155	013G8030	1-1/4"	93.93



# Valves

## Supply Valves

### Model 185 Supply Valves (MNPT)

- For 2-pipe steam or water heating system
- Modulating with dial and pointer
- Brass construction
- Non-rising, spring packed handle
- Opens and closes in less than one turn
- Arrow on handle indicates "ON" and "OFF" direction
- Operating pressure: 25" Hg vacuum to 150 psig for steam service; 150 psig max for water service
- Maximum pressure: 150 psig



Part #	Mfg #	Size	Pattern	Price
46441	185	1/2" MNPT	Angle	74.64
38708	185	3/4" MNPT	Angle	87.96
176873	185	1" MNPT	Angle	111.95
181737	185	1-1/4" MNPT	Angle	156.37



## Compressed Air Treatment

### F602 Standard Filters

- For heavy-duty applications with minimum pressure drop requirement
- Unique deflector plate creates swirling of air stream ensuring maximum water & dirt separation
- 40 Micron filter standard

### Poly carbonate Bowl/Plastic Guard - Manual Twist Drain

- Ideal for use with filters & lubricators
- Suitable for use in industrial environments
- Not for use in fire-resistant systems
- Do not locate in areas where subjected to sunlight, impact blow, or temperatures outside the rated range; do not expose to chlorinated hydro-carbons, ketones, esters & certain alcohols



Part #	Mfg #	Port	High Flow SCFM @ 5 psi	Price
16305	F602-02BJ	1/4"	45	66.00
16306	F602-03BJ	3/8"	68	66.00
16307	F602-04BJ	1/2"	90	90.64

### Filter Element

Part #	Mfg #	Size	Price
192992	602-C77-1-40	40 Micron	43.48

## R119 Standard Regulators - High Flow

- For constant pressure with wide variation in flow installations
- Diaphragm operated design with balanced poppet design
- Secondary aspiration plus balanced poppet
- Heavy-duty tee handle adjustment



### Without Gauge 0-125 psig Reduced Pressure (NPT)

Part #	Mfg #	Port	High Flow SCFM @ 5 psi	Price
16298	R119-02C	1/4"	100	68.32
16299	R119-03C	3/8"	110	68.32
16301	R119-04C	1/2"	150	81.48
16302	R119-06C	3/4"	300	135.79
16303	R119-08C	1"	400	135.79

## R119 Gauge

- 2" Dial size, 1/4" Back connection

Part #	Mfg #	PSIG	Price
16313	275Y160S	0 - 160	13.06

## Miniature FRL Series

### Air Line Filter/Regulators - Miniature

- Excellent water removal efficiency
- Unbalanced poppet standard
- Solid control piston for extended life
- Non-rising adjustment knob



Part #	Mfg #	Port	High Flow SCFM @ 5 psi	Price
16304	B548-02AHC	1/4"	12	54.11

## Air Line Regulators - High Flow, High Sensitivity

- Constant bleed for semi-precision applications
- Can be used for water service 1.25 gpm
- Unbalanced poppet standard
- Diaphragm operated
- Non-rising adjusting knob



Part #	Mfg #	Port	High Flow SCFM @ 100 psi	Price
115620	R364-01C	1/8" Brass	10	30.74

### With Gauge

Part #	Mfg #	Port	High Flow SCFM @ 100 psi	Price
220814	R364-02CG	1/4" Brass	10	44.53

Heating





## Ball Valves - Bronze

### Apollo Bronze Ball Valves

#### 70-100 Series with Standard Lever Handle (FNPT)

- Blow-out proof stem design
- Adjustable packing gland
- Chromium plated ball
- RPTFE seats & stuffing box ring
- Pressure ratings:  
 600 psig CWP Non-Shock  
 150 psig Saturated Steam



Part #	Mfg #	Size	Type	Price
1310	70-101-01	1/4"	IPS	13.00
1311	70-102-01	3/8"	IPS	13.00
1312	70-103-01	1/2"	IPS	13.00
1313	70-104-01	3/4"	IPS	21.46
1314	70-105-01	1"	IPS	27.01
1315	70-106-01	1-1/4"	IPS	45.32
1316	70-107-01	1-1/2"	IPS	57.86
1317	70-108-01	2"	IPS	72.51
1318	70-109-01A	2-1/2"	IPS	342.10
1319	70-100-01	3"	IPS	394.73
1320	70-10A-01	4"	IPS	521.55

#### 70-200 Series with Standard Lever Handle (CxSWEAT)

- Blow-out proof stem design
- Adjustable packing gland
- Chromium plated ball
- RPTFE seats & stuffing box ring
- Adjustable packing gland
- Pressure ratings:  
 600 psig WOG, Cold Non-Shock  
 150 psig Saturated steam
- Vacuum service to 29 inches HG



Part #	Mfg #	Size	Type	Price
1329	70-202-01	3/8"	C x C	13.00
1330	70-203-01	1/2"	C x C	13.00
1331	70-204-01	3/4"	C x C	21.46
1332	70-205-01	1"	C x C	27.01
1333	70-206-01	1-1/4"	C x C	45.32
1334	70-207-01	1-1/2"	C x C	57.86
1335	70-208-01	2"	C x C	72.51
1336	70-209-01A	2-1/2"	C x C	342.10
1337	70-200-01	3"	C x C	394.73

#### 70-100 Series with Stainless Steel Ball & Stem Option (FNPT)

Part #	Mfg #	Size	Type	Price
1357	70-141-01	1/4"	IPS	19.51
1358	70-142-01	3/8"	IPS	19.51
1359	70-143-01	1/2"	IPS	19.51
1360	70-144-01	3/4"	IPS	36.11
1361	70-145-01	1"	IPS	43.72
1362	70-146-01	1-1/4"	IPS	72.57
1363	70-147-01	1-1/2"	IPS	97.67
1364	70-148-01	2"	IPS	129.06
1365	70-149-01A	2-1/2"	IPS	513.42
1366	70-140-01	3"	IPS	593.80

#### 70-200 Series Ball Valves with 316SS Ball & Stem (CxSWEAT)

- 70-200 Standard features

Part #	Mfg #	Size	Type	Price
120349	70-242-01	3/8"	C x C	Call
1367	70-243-01	1/2"	C x C	19.51
1352	70-244-01	3/4"	C x C	22.04
1369	70-245-01	1"	C x C	43.72
1370	70-246-01	1-1/4"	C x C	72.57
1371	70-247-01	1-1/2"	C x C	97.67
1372	70-248-01	2"	C x C	129.06
1373	70-249-01	2-1/2"	C x C	513.42
1374	70-240-01	3"	C x C	593.80

#### WBVC Series Brass Standard Port Ball Valves

- For full range of gases & liquids on commercial residential and industrial applications

##### WBVC Ball Valves (Compression)

- Pressure rating: 400 psi WOG, 150 psi WSP



Part #	Mfg #	Size	Type	Price
123957	0545305	WBVC 1/2"		19.03
123959	0545306	WBVC 3/4"		25.85
182679	0545307	WBVC 1"		36.90

Valves



## Ball Valves - Bronze



### 70-100 Series Bronze Standard Port Ball Valves

- Blow-out proof stem design
- Adjustable packing gland
- Chromium plated ball
- RPTFE seats & stuffing box ring
- Pressure ratings:  
 600 psig CWP Non-Shock  
 150 psig Saturated Steam

#### 70-100 Series with Steel Tee Handle Option (FNPT)

- Gas cock style

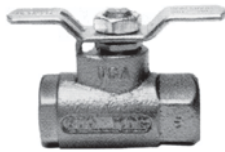

Part #	Mfg #	Size	Type	Price
1498	70-102-07	3/8"	IPS	13.00
1499	70-103-07	1/2"	IPS	13.00
1500	70-104-07	3/4"	IPS	21.46
1501	70-105-07	1"	IPS	27.01
1502	70-106-07	1-1/4"	IPS	45.32
1503	70-107-07	1-1/2"	IPS	57.86
1504	70-108-07	2"	IPS	72.51

### 70-100 Series Rough Chrome Plated (FNPT)

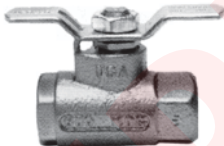

Part #	Mfg #	Size	Type	Price
1321	70-103-17	1/2"	IPS	17.23
1322	70-104-17	3/4"	IPS	25.69

### 70-100 Series with SS Latch Lock Lever, Auto-Drain (FNPT)

Part #	Mfg #	Size	Type	Price
40262	70-103-27-41	1/2"	IPS	18.43
53394	70-104-27-41	3/4"	IPS	26.91
53395	70-105-27-41	1"	IPS	34.30

### 70-100 Series with Automatic Drain Option (FNPT)

- Auto drain when pneumatic tools are shut off
- Conforms to certain OSHA requirements



Part #	Mfg #	Size	Type	Price
33532	70-101-41	1/4"	IPS	14.90

### Apollo Bronze Ball Valves (Continued)

#### 70-100 Series Bronze Standard Port Ball Valves

##### 70-100 Series with Automatic Drain Option (FNPT)

Part #	Mfg #	Size	Type	Price
33533	70-102-41	3/8"	IPS	14.90
1348	70-103-41	1/2"	IPS	14.90
1349	70-104-41	3/4"	IPS	23.34
1350	70-105-41	1"	IPS	30.78
33534	70-106-41	1-1/4"	IPS	51.03
33535	70-107-41	1-1/2"	IPS	63.56
33536	70-108-41	2"	IPS	78.19

### Lock Lever Ball Valves

#### 70-100 Series with SS Latch Lock Lever Option (FNPT)

- Sliding lock mechanism secures handle in open or closed position
- Valve can also be padlocked open or closed



Part #	Mfg #	Size	Type	Price
1338	70-101-27	1/4"	IPS	16.52
1339	70-102-27	3/8"	IPS	16.52
1340	70-103-27	1/2"	IPS	16.52
1341	70-104-27	3/4"	IPS	24.98
1342	70-105-27	1"	IPS	30.52
1343	70-106-27	1-1/4"	IPS	48.83
1344	70-107-27	1-1/2"	IPS	61.39
1345	70-108-27	2"	IPS	76.03
1346	70-109-27	2-1/2"	IPS	352.56
1347	70-100-27	3"	IPS	405.14

#### 70-200 Series with SS Latch Lock Lever Option

- 70-200 Standard features with:
  - Sliding lock mechanism secures handle in open or closed position
  - Valve can also be padlocked open or closed

Part #	Mfg #	Size	Type	Price
1492	70-203-27	1/2"	C x C	16.69
1493	70-204-27	3/4"	C x C	25.14
1494	70-205-27	1"	C x C	30.69
1495	70-206-27	1-1/4"	C x C	49.00
1496	70-207-27	1-1/2"	C x C	61.55
1497	70-208-27	2"	C x C	76.20
33546	70-209-27	2-1/2"	C x C	353.02
33547	70-200-27	3"	C x C	405.64



## Ball Valves - Bronze

### 75-100 Series Bronze Padlocking Ball Valves

- Can be padlocked open or closed with same hardware
- Blow-out proof stem design
- RPTFE sets and stuffing box ring
- Adjustable packing gland
- Chromium plated ball
- Pressure ratings:  
 600 psig WOG cold non-shock  
 150 psig Saturated Steam



75-100-41

### 75-100 Series Less Automatic Drain Option (FNPT)

Part #	Mfg #	Size	Type	Price
1436	75-101-01	1/4"	IPS	26.45
1437	75-102-01	3/8"	IPS	26.45
1438	75-103-01	1/2"	IPS	26.45
1439	75-104-01	3/4"	IPS	41.94
1440	75-105-01	1"	IPS	41.94

### 75-100 Series with Automatic Drain Option (FNPT)

Part #	Mfg #	Size	Type	Price
1446	75-103-41	1/2"	IPS	28.36
1447	75-104-41	3/4"	IPS	43.82
1448	75-105-41	1"	IPS	45.72
1449	75-106-41	1-1/4"	IPS	70.09
1450	75-107-41	1-1/2"	IPS	83.55
1451	75-108-41	2"	IPS	98.22

### 70-140 Series Bronze 250# Steam Ball Valve

- Stainless steel ball and stem
- Multi-filled RPTFE seats
- ASTM B584 Bronze
- Special high-temperature MTFE stem packing
- 250 SWP Rating
- Thermal relief ball design



### 70-140 Series with Steel Trim Option

Part #	Mfg #	Size	Type	Price
1392	70-141-64	1/4"	IPS	26.60
1393	70-142-64	3/8"	IPS	26.60
1394	70-143-64	1/2"	IPS	26.62
1395	70-144-64	3/4"	IPS	43.22
1396	70-145-64	1"	IPS	50.83
1397	70-146-64	1-1/4"	IPS	84.96
1398	70-147-64	1-1/2"	IPS	110.06
1399	70-148-64	2"	IPS	141.46
1400	70-149-64	2-1/2"	IPS	527.57
1401	70-140-64	3"	IPS	607.96

### 70 Series Bronze Ball Valves (Single Union End x IPS)

- Blowout-proof stem design
- Viton® O-Ring sealed union requires light torque for proper seal
- Chromium-plated ball
- Adjustable packing gland
- Pressure ratings:  
 600 psig WOG Cold, non-shock  
 150 psig Saturated steam



### 70-300 Series (FNPT)

Part #	Mfg #	Size	Type	Price
1375	70-303-01	1/2"	IPS	19.67
1376	70-304-01	3/4"	IPS	33.39
1377	70-305-01	1"	IPS	45.10
1378	70-306-01	1-1/4"	IPS	76.65
1379	70-307-01	1-1/2"	IPS	95.94
1380	70-308-01	2"	IPS	149.77

### 70-400 Series (Copper Union)

Part #	Mfg #	Size	Type	Price
147205	70-402-01	3/8"	C x C	18.49
1511	70-403-01	1/2"	C x C	19.67
1512	70-404-01	3/4"	C x C	33.39
1513	70-405-01	1"	C x C	45.10

### 70 Series Bronze 3-Way Diverter Ball Valves

- Ideal for applications requiring flow diversion
- Combines the features of (2) 2-way valves
- Large ports make tank selection and fluid transfers simpler
- Easy 1/4-turn operation
- 100% Air tested under water
- Pressure rating: 400 psig WOG
- Also available in C x C with Stainless



### 70-600 Series (FNPT)

Part #	Mfg #	Size	Type	Price
181809	70-602-01	3/8"	IPS	23.59
1381	70-603-01	1/2"	IPS	23.59
1382	70-604-01	3/4"	IPS	32.54
1383	70-605-01	1"	IPS	43.11
1384	70-606-01	1-1/4"	IPS	68.15
1385	70-607-01	1-1/2"	IPS	79.55
1386	70-608-01	2"	IPS	114.52



## Ball Valves - Bronze



### 70-600 Series with SS Ball & Trim (FNPT)

Part #	Mfg #	Size	Type	Price
895095	70-642-01	3/8"	IPS	Call
134946	70-643-01	1/2"	IPS	29.61
45095	70-644-01	3/4"	IPS	47.20
45094	70-645-01	1"	IPS	Call
198496	70-646-01	1-1/4"	IPS	Call
134947	70-647-01	1-1/2"	IPS	119.36
134949	70-648-01	2"	IPS	188.88

### 71-140 Series with 316SS Ball & Stem (FNPT)

- Mounting Pads
- Actuator Ready

Part #	Mfg #	Size	Type	Price
1410	71-144-01	3/4"	IPS	43.09
1411	71-145-01	1"	IPS	52.13
1412	71-146-01	1-1/4"	IPS	80.47
1413	71-147-01	1-1/2"	IPS	106.36
1414	71-148-01	2"	IPS	148.46

### 71-500 Series Bronze Shut-Off Valves with Spring Return Handle (Deadman)

- Ideal in applications where the valve must be in OFF position at all times
- Can be used in reverse with 90° reverse stem option
- All lever components are stainless steel
- Torque nearly 3 times that of standard valves
- Pressure ratings:  
600 psig WOG cold, non-shock  
150 psig Saturated steam



### 71-500 Series Spring Return to Close Handle (FNPT)

Part #	Mfg #	Size	Type	Price
1402	71-501-01	1/4"	IPS	90.86
1403	71-502-01	3/8"	IPS	90.86
1404	71-503-01	1/2"	IPS	90.86
1405	71-504-01	3/4"	IPS	101.78
1406	71-505-01	1"	IPS	108.67
1407	71-506-01	1-1/4"	IPS	140.50
1408	71-507-01	1-1/2"	IPS	167.15
1409	71-508-01	2"	IPS	196.64

### 77 Series Bronze Full Port Ball Valves

- 2-Piece bronze body
- Designed where highest Cv values are desired
- Chromium-plated ball
- RPTFE seats
- Stuffing box ring
- Full flow and minimum pressure drop
- Pressure rating: 600 psi CWP



### 77-100 Series with Standard Lever Handle (FNPT)

Part #	Mfg #	Size	Type	Price
137403	77-101-01	1/4"	IPS	17.55
1467	77-103-01	1/2"	IPS	17.55
1468	77-104-01	3/4"	IPS	31.98
1469	77-105-01	1"	IPS	44.80
1470	77-106-01	1-1/4"	IPS	63.20
1471	77-107-01	1-1/2"	IPS	79.75
1472	77-108-01	2"	IPS	138.58
1473	77-109-01	2-1/2"	IPS	360.15

### 77-100 Series with SS Ball & Stem Option (FNPT)

Part #	Mfg #	Size	Type	Price
35595	77-143-01	1/2"	IPS	24.26
1474	77-144-01	3/4"	IPS	45.51
1475	77-145-01	1"	IPS	72.53
1476	77-146-01	1-1/4"	IPS	97.30
1477	77-147-01	1-1/2"	IPS	119.68
1478	77-148-01	2"	IPS	198.23

### 77-200 Series with Standard Lever Handle (Sweat)



Part #	Mfg #	Size	Type	Price
1479	77-204-01	3/4"	C x C	30.46
1480	77-205-01	1"	C x C	42.47
1481	77-206-01	1-1/4"	C x C	57.16
1482	77-207-01	1-1/2"	C x C	73.73
1483	77-208-01	2"	C x C	133.35
161195	77-209-01	2-1/2"	C x C	353.41

### 77-200 Series with SS Ball & Stem Option (Sweat)

Part #	Mfg #	Size	Type	Price
33543	77-244-01	3/4"	C x C	44.02
1484	77-245-01	1"	C x C	70.22



## Ball Valves - Bronze



### Apollo Bronze Ball Valves (Continued)

#### 77 Series Bronze Full Port Ball Valves

#### 77-200 Series with SS Ball & Stem Option (Sweet)

Part #	Mfg #	Size	Type	Price
33544	77-246-01	1-1/4"	C x C	91.25
1485	77-247-01	1-1/2"	C x C	113.64
33545	77-248-01	2"	C x C	193.02
234539	77-249-01	2-1/2"	C x C	326.92

#### 80-100 Series Bronze UL Listed LP Gas Shut-Off Valves

- UL listed for LP-gas, natural gas, flammable liquid and heated oil
- 1-Piece bronze body
- Large ports to reduce pressure drop
- RPTFE seats and seals
- Blow-out proof stem design
- Adjustable packing gland
- Chromium plated ball
- 1/4-Turn On - Off



#### 80-100 Series with Standard Lever Handle (FNPT)

Part #	Mfg #	Size	Type	Price
33556	80-101-01	1/4"	IPS	15.84
33557	80-102-01	3/8"	IPS	15.84
1520	80-103-01	1/2"	IPS	15.84
1521	80-104-01	3/4"	IPS	24.12
1522	80-105-01	1"	IPS	33.40
33558	80-106-01	1-1/4"	IPS	54.72
33559	80-107-01	1-1/2"	IPS	66.65
33560	80-108-01	2"	IPS	80.85
33561	80-109-01	2-1/2"	IPS	367.31
33562	80-100-01	3"	IPS	432.38

#### 80-100 Series with Steel Tee Handle (FNPT)

Part #	Mfg #	Size	Type	Price
173979	80-103-07	1/2"	IPS	15.84
179420	80-104-07	3/4"	IPS	21.15
179918	80-105-07	1"	IPS	33.40

### 82-100 Series Bronze 3-Piece Full Port Ball Valves (FNPT)

- 3-Piece bronze body
- In-line repairable threaded ball valve offers RPTFE seats and seals
- SAE Grade 8 body bolts standard
- Adjustable packing nut
- Pressure ratings:  
600 psig WOG, cold non-shock  
150 psig saturated steam



Part #	Mfg #	Size	Type	Price
1523	82-101-01	1/4"	IPS	33.37
1524	82-102-01	3/8"	IPS	33.37
1525	82-103-01	1/2"	IPS	38.67
1527	82-105-01	1"	IPS	62.28
1528	82-106-01	1-1/4"	IPS	89.53
1529	82-107-01	1-1/2"	IPS	115.90
1530	82-108-01	2"	IPS	212.37
1531	82-109-01	2-1/2"	IPS	506.91
33562	82-100-01	3"	IPS	432.38

#### 82-100 Series with 316SS Ball & Stem Option (FNPT)

Part #	Mfg #	Size	Type	Price
1534	82-143-01	1/2"	IPS	54.63
1535	82-144-01	3/4"	IPS	65.29
1536	82-145-01	1"	IPS	95.01
1537	82-146-01	1-1/4"	IPS	128.55
1538	82-147-01	1-1/2"	IPS	163.84
1539	82-148-01	2"	IPS	267.55
54802	82-149-01	2-1/2"	IPS	546.83
1532	82-140-01	3"	IPS	928.00



## Ball Valves - Bronze



### 82-200 Series Bronze 3-Piece Full Port Valves (Sweat)

- 3-Piece bronze body
- Full port and is easily repaired in-line
- Designed for soft sweating or brazed installation
- Includes RPTFE seats and seals
- Chromium-plated ball
- Equipped with SAE grade 8 body bolts
- Pressure ratings:  
 600 psig WOG cold, non-shock  
 150 psig saturated steam



#### 82-200 Series with 316SS Ball & Stem Option (Sweat)

Part #	Mfg #	Size	Type	Price
1550	82-243-01	1/2"	C x C	54.63
1551	82-244-01	3/4"	C x C	65.29
1552	82-245-01	1"	C x C	95.01
1553	82-246-01	1-1/4"	C x C	128.63
1554	82-247-01	1-1/2"	C x C	163.84
1555	82-248-01	2"	C x C	267.44
39864	82-249-01	2-1/2"	C x C	546.83
1548	82-240-01	3"	C x C	928.00
1549	82-24A-01	4"	C x C	1748.24

### 82-200 Series Bronze Full Port Valves with Brazed Tubing for Medical Gas

- 3-Piece bronze body
- Full port and is easily repaired in-line
- Useful in pharmaceutical, medical gas & pneumatic application where valves should not be disassembled prior to sweating or brazing



#### 82-200 Series Cleaned for Oxygen Service (Sweat)

- Individually bagged

Part #	Mfg #	Size	Type	Price
37655	82-203-57	1/2"	C x C	47.37
38323	82-204-57	3/4"	C x C	56.15
49134	82-205-57	1"	C x C	70.98
92583	82-206-57	1-1/4"	C x C	98.67
35603	82-207-57	1-1/2"	C x C	124.59
92582	82-208-57	2"	C x C	221.06

### 82-200 Series Cleaned for Oxygen Service (Sweat) with Extension Tubes

- With extension tubes
- Individually bagged

Part #	Mfg #	Size	Type	Price
48669	82-203-A1	1/2"	C x C	76.62
48671	82-204-A2	3/4"	C x C	83.15
92447	82-205-A1	1"	C x C	104.70
92448	82-206-A1	1-1/4"	C x C	145.44
92449	82-207-A1	1-1/2"	C x C	174.96
184960	82-208-A1	2"	C x C	247.34

### 70-100 Series Cleaned for Oxygen Service (FNPT)

Part #	Mfg #	Size	Type	Price
1505	70-103-57	1/2"	IPS	21.71
1506	70-104-57	3/4"	IPS	30.16
1507	70-105-57	1"	IPS	35.71

### 95 Series Bronze Full Port Stop & Drain Ball Valves

- Chromium-plated ball
- RPTFE sets and stuffing box ring
- Drain cap designed to prevent loss
- Blow-out proof stem design
- Adjustable packing gland
- Rugged construction
- Pressure ratings:  
 400 psig WOG cold non-shock



#### 95-100 Series (FNPT)

Part #	Mfg #	Size	Type	Price
1650	95-103-01	1/2"	IPS	16.96
1651	95-104-01	3/4"	IPS	31.58
1652	95-105-01	1"	IPS	38.93

#### 95-200 Series (Sweat)

Part #	Mfg #	Size	Type	Price
1653	95-203-01	1/2"	C x C	16.96
1654	95-204-01	3/4"	C x C	31.58
1655	95-205-01	1"	C x C	38.93



## Ball Valves - Bronze



### Specialty Valves

#### 78-256 Series Bronze Fuel Shut-Off Valve with Mounting Ears (FNPT)

- Excellent for use with liquid fuels and in marine applications
- All wetted parts are brass or cast bronze
- NPT threaded, both ends
- RPTFE seats and seals
- Pressure ratings:  
400 psig Service rating tested to 100 psig under water



Part #	Mfg #	Size	Type	Price
135420	78-256-01	1/2"	IPS	23.20
41981	78-438-01	3/4"	IPS	31.73

#### 70 Series Hose Bronze Ball Valve with Cap & Chain

- Cast-Bronze Ball Valves With Cap and Chain
- An attached cap helps prevent thread damage. Standard port with RPTFE seats. FNPT x Hose connections. For use with water, oil, and gas.
- Max. pressure: 450 psi WOG
- Temp. range: -20° to 450°F

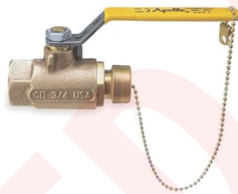

#### 70 Series (NPT x Hose)

Part #	Mfg #	Size	Type	Price
1486	70-103-HC	1/2" x 3/4"NPT x Hose		21.88
1487	70-104-HC	3/4" x 3/4"NPT x Hose		30.89
855512	70-105-HC	1" x 3/4" NPT x Hose		39.90

#### 70 Series (Sweat x Hose)



Part #	Mfg #	Size	Type	Price
1488	70-203-HC	1/2" x 3/4" C x Hose		21.88
1489	70-204-HC	3/4" x 3/4" C x Hose		30.89

### 94-A Series Full Port Brass Ball Valve

- The Apollo® International 94A forged brass ball valves combine reliable operation with maximum economy.
- Full-Port
- Blow-out proof stem design
- Adjustable stem packing nut
- Silicone free
- Valve design rating: 600 CWP (400 CWP 2-1/2" to 4")
- Temperature range 0°F - 400°F



Part #	Mfg #	Size	Type	Price
902609	94A-101-01	1/4"	IPS	5.91
902610	94A-102-01	3/8"	IPS	5.91
902612	94A-103-01	1/2"	IPS	6.06
792071	94A-104-01	3/4"	IPS	9.36
792070	94A-105-01	1"	IPS	14.41
792069	94A-106-01	1-1/4"	IPS	21.60
792068	94A-107-01	1-1/2"	IPS	32.70
792067	94A-108-01	2"	IPS	51.50
902627	94A-109-01	2-1/2"	IPS	138.84
902628	94A-100-01	3"	IPS	173.01
902630	94A-10A-01	4"	IPS	345.00

### Press Ball Valves

#### 77W Series Apollo Press Ball Valves

- The Apollo-Press™ press x press ball valves are designed for direct mechanical connection to ASTM B88-Type K, L, and M copper tubing in the hard drawn condition for sizes 1/2"-2".
- Full-Port
- Adjustable stem packing
- Fast, easy, economical installation ; 704-841-6000
- Blow-Out proof stem
- Corrosion resistant materials
- 100% factory tested
- Silicon free
- Ridgid® press tool compatible
- Maximum operating pressure 200 psi
- Design pressure 600 psi
- Temperature range 0°F-200°F



Part #	Mfg #	Size	Type	Price
884797	77W-103-01	1/2"	Press	23.67
884798	77W-104-01	3/4"	Press	32.31



## Ball Valves - Bronze



### Press Ball Valves (Continued)

#### 77W Series Apollo Press Ball Valves

Part #	Mfg #	Size	Type	Price
884799	77W-105-01	1"	Press	35.26
884800	77W-106-01	1-1/4"	Press	79.74
884801	77W-107-01	1-1/2"	Press	108.18
884802	77W-108-01	2"	Press	181.80

#### Cimpress Press Ball Valves

- DZR "CR" corrosion-resistant brass
- Double EPDM-ASTM D 2000 M2 O-Rings
- Working Pressure:  
1/2" - 2" : 250 PSI
- Max. operating temperature: working limit for fluids -4° F - 248° F



Part #	Mfg #	Size	Type	Price
858924	1220-04	1/2"	Press	21.59
858925	1220-06	3/4"	Press	27.63
858926	1220-07	1"	Press	36.18
858927	1220-08	1-1/4"	Press	73.18
858928	1220-09	1-1/2"	Press	106.85
858929	1220-10	2"	Press	144.16
919257	220XLC-11	2-1/2"	Press	273.29
919258	220XLC-12	3"	Press	437.99
919445	220XLC-14	4"	Press	669.34

#### Press x Hose End (with Cap & Chain)

Part #	Mfg #	Size	Type	Price
920995	222H-04	1/2"	Press x Hose	28.65
920996	222H-06	3/4"	Press x Hose	36.47

### Apollo Carbon Steel Ball Valves

#### 72-100 Series Carbon Steel High Pressure Ball Valves (FNPT)

- Bar stock design
- RPTFE Seats and stuffing box ring
- Fire safe design when ordered with graphite packing
- Nitride corrosion protection
- Adjustable packing gland
- Full port, except 2"
- Blow-out proof stem design
- Heavy duty lever
- Pressure ratings:  
3000 psig WOG cold, non-shock  
150 psig saturated steam



#### 72-100 Series Standard with Lever Handle (FNPT)

Part #	Mfg #	Size	Type	Price
1416	72-103-01	1/2"	IPS	59.44
1417	72-104-01	3/4"	IPS	73.86
1418	72-105-01	1"	IPS	111.37
1419	72-106-01	1-1/4"	IPS	170.24
1420	72-107-01	1-1/2"	IPS	214.71
1421	72-108-01	2"	IPS	264.41

#### 73-100 Series Carbon Steel Standard Port Ball Valves (FNPT)

- 2-Piece carbon steel body
- PTFE Seats & packing
- Blow-out proof stem design
- Adjustable packing gland
- Forged construction
- Nitride corrosion protection
- Raised handle stops
- Pressure ratings:  
2000 psig WOG 1/4" to 2"  
1500 psig WOG cold, non-shock  
150 psig saturated steam



#### 73A-100 Series Standard - Actuator Ready (FNPT)

- Actuator mounting pads

Part #	Mfg #	Size	Type	Price
1423	73A-102-01	3/8"	IPS	24.79
1424	73A-103-01	1/2"	IPS	26.93
1425	73A-104-01	3/4"	IPS	38.90
1426	73A-105-01	1"	IPS	52.34
1427	73A-106-01	1-1/4"	IPS	89.44
1428	73A-107-01	1-1/2"	IPS	113.31

Valves





## Ball Valves - Steel



### Apollo Carbon Steel Ball Valves (Continued)

#### 73-100 Series Carbon Steel Standard Port Ball Valves (FNPT)

##### 73A-100 Series Standard - Actuator Ready (FNPT)

Part #	Mfg #	Size	Type	Price
1429	73A-108-01	2"	IPS	156.03

##### 73A-100 Series with 316SS Ball & Stem (FNPT)

- Actuator mounting pads

Part #	Mfg #	Size	Type	Price
113899	73A-141-01A	1/4"	IPS	36.73
242410	73A-142-01A	3/8"	IPS	36.54
1430	73A-143-01A	1/2"	IPS	38.85
1431	73A-144-01A	3/4"	IPS	60.83
1432	73A-145-01A	1"	IPS	74.21
1433	73A-146-01	1-1/4"	IPS	115.33
1434	73A-147-01	1-1/2"	IPS	147.15
1435	73A-148-01	2"	IPS	192.81

##### 73A-100 Series with 316SS Ball & Stem, Steam Trim (FNPT)

- Actuator mounting pads
- 250 SWP

Part #	Mfg #	Size	Type	Price
43382	73A-141-64	1/4"	IPS	44.34
37469	73A-142-64	3/8"	IPS	44.34
37470	73A-143-64A	1/2"	IPS	47.04
37471	73A-144-64A	3/4"	IPS	69.02
37473	73A-145-64	1"	IPS	81.86
92109	73A-146-64	1-1/4"	IPS	128.61
43381	73A-147-64	1-1/2"	IPS	160.44
46063	73A-148-64	2"	IPS	206.15

### 83A Series 3-Piece Full Port Actuator Ready Carbon Steel 1500 CWP NPT Ball Valve

- 3-Piece construction with enclosed fasteners
- Two-position locking
- Full port
- Adjustable multi-piece PTFE "V" style packing
- Stainless steel trim & hardware
- Fully machined ISO 5211 mounting
- Swing-out center section
- Cast bosses on the center-section and end caps
- Pressure balanced solid ball for bleed & drain ports
- Compression controlled RPTFE gaskets
- Vacuum service to 29 in of Hg
- Anti-blowout one piece bottom entry stem
- 150 psig saturated steam



#### 83A-140 Series - IPS

Part #	Mfg #	Size	Type	Price
884658	83A-143-01	1/2"	IPS	104.39
884659	83A-144-01	3/4"	IPS	138.57
884660	83A-145-01	1"	IPS	172.77
884661	83A-146-01	1-1/4"	IPS	230.36
884662	83A-147-01	1-1/2"	IPS	300.55
884664	83A-148-01	2"	IPS	397.76

#### 83A-240 Series - Socket Weld

Part #	Mfg #	Size	Type	Price
884653	83A-243-01	1/2"	IPS	104.39
884654	83A-244-01	3/4"	IPS	138.57
884728	83A-245-01	1"	IPS	172.77
884655	83A-246-01	1-1/4"	IPS	230.36
884656	83A-247-01	1-1/2"	IPS	300.55
884657	83A-248-01	2"	IPS	397.76

CELEBRATING  
**75** YEARS  
 1934 • 2010

Metropolitan Pipe recently celebrated 75 years of operation. Our staff, with over a century of combined experience, is always ready to tackle your next job. No one knows the industry better!



## Ball Valves - Steel



### 88A Series 150# Flanged Carbon Steel Ball Valves

- ANSI
- 2-Position locking device
- CHV Style adjustable stem seals
- 4-Point ISO 5211 mounting pad bolt pattern
- Slot vented ball for thermal expansion
- Anti-static grounded ball & stem
- Blow-out proof stem design
- Cast Boss for bleed/drain port
- Pressure ratings:  
150 psig Saturated steam
- Vacuum service to 29 inches HG



#### 88A-100 Series Flanged Standard Port

Part #	Mfg #	Size	Type	Price
33576	88A-107-01	1-1/2"	Flanged	462.93
1628	88A-108-01	2"	Flanged	517.83
1629	88A-109-01	2-1/2"	Flanged	725.16
1630	88A-100-01	3"	Flanged	790.48
1631	88A-10A-01	4"	Flanged	1382.16

#### 88A-100 Series Flanged Standard Port with Stainless Steel Ball & Stem

Part #	Mfg #	Size	Type	Price
1633	88A-147-01A	1-1/2"	Flanged	496.07
1634	88A-148-01	2"	Flanged	561.37
1635	88A-149-01	2-1/2"	Flanged	749.79
1636	88A-140-01	3"	Flanged	920.16
1637	88A-14A-01	4"	Flanged	1486.32
118142	88A-14C-01	6"	Flanged	3243.32

### Apollo 316SS Ball Valves

#### 76-100 Series Stainless Steel Standard Port Ball Valves

- 2-Piece cast stainless steel body
- RPTFE seats and stuffing box ring
- Mounting pad for easy actuator mounting
- Blow-out proof stem design
- Adjustable packing gland
- SS lever and nut
- Pressure ratings cold non-shock:  
1/4" to 1" 2000 psig WOG  
1-1/4" to 2" 1500 psig WOG  
2-1/2" to 3" 1000 psig WOG;  
150 psig saturated steam

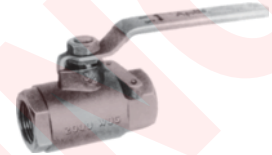

#### 76-100 Series with Standard Lever Handle (FNPT)

Part #	Mfg #	Size	Type	Price
1452	76-101-01	1/4"	IPS	55.36
1453	76-102-01	3/8"	IPS	55.36
1454	76-103-01	1/2"	IPS	55.36
1455	76-104-01	3/4"	IPS	91.74
1456	76-105-01	1"	IPS	111.76
1457	76-106-01	1-1/4"	IPS	212.84
1458	76-107-01	1-1/2"	IPS	222.41
1459	76-108-01	2"	IPS	288.72
1460	76-109-01	2-1/2"	IPS	983.03
1461	76-100-01	3"	IPS	1068.76

#### 76-100 Series with 250# Steam Trim Option (FNPT)

Part #	Mfg #	Size	Type	Price
118982	76-101-64	1/4"	IPS	55.77
140127	76-102-64	3/8"	IPS	Call
45875	76-103-64	1/2"	IPS	62.86
135160	76-104-64	3/4"	IPS	99.24
45879	76-105-64A	1"	IPS	70.28
Call	76-106-64	1-1/4"	IPS	Call
141083	76-107-64	1-1/2"	IPS	Call
38394	76-108-64	2"	IPS	Call
Call	76-109-64	2-1/2"	IPS	Call
892986	76-100-64	3"	IPS	Call

Valves



## Ball Valves - Stainless Steel

### 76F-100 Series Stainless Steel Full Port Ball Valves

- 2-Piece cast stainless steel body
- RPTFE seats and stuffing box ring
- Mounting pad for easy actuator mounting
- Blow-out proof stem design
- Adjustable packing gland
- SS lever and nut
- Pressure ratings:  
1000 psig CWP cold non-shock saturated steam
- Vacuum service to 29 inches HG



Part #	Mfg #	Size	Type	Price
190155	76F-101-01	1/4"	IPS	30.51
190156	76F-102-01	3/8"	IPS	30.51
190157	76F-103-01	1/2"	IPS	32.12
190158	76F-104-01	3/4"	IPS	43.35
190160	76F-105-01	1"	IPS	62.63
190168	76F-106-01	1-1/4"	IPS	80.27
190169	76F-107-01	1-1/2"	IPS	120.41
190161	76F-108-01	2"	IPS	152.53

### 76-500 Series Stainless Steel Ball Valves with Spring Return Handle (Deadman)

- Stainless steel cast components
- RPTFE seats and stuffing box ring
- All components of lever are stainless steel
- Operating torque is approximately three times standard valve torque
- Blow-out proof stem design
- Adjustable packing gland
- Pressure ratings:  
1/4" to 1" 2000 psig WOG 1-1/4" to 2" 1500 psig WOG cold non-shock 150 psig saturated steam



#### 76-500 Series Spring Return to Close Handle (FNPT)

Part #	Mfg #	Size	Type	Price
48680	76-501-01	1/4"	IPS	117.72
1517	76-503-01	1/2"	IPS	117.72
1518	76-504-01	3/4"	IPS	152.39
1519	76-505-01	1"	IPS	171.29
48682	76-506-01	1-1/4"	IPS	Call
48683	76-507-01	1-1/2"	IPS	325.00
48677	76-508-01	2"	IPS	373.40

### 76-600 Series Stainless Steel 3-Way Diverter Ball Valves (FNPT)

- Stainless steel cast components
- Blow-out proof stem design
- Adjustable packing gland
- Pressure ratings:  
285 psig WOG Cold, non-shock

Part #	Mfg #	Size	Type	Price
181863	76-601-01	1/4"	IPS	116.39
181864	76-602-01	3/8"	IPS	116.39
1462	76-603-01	1/2"	IPS	116.39
1463	76-604-01	3/4"	IPS	155.91
1464	76-605-01	1"	IPS	193.84
939681	76-606-01	1-1/4"	IPS	Call
1465	76-607-01	1-1/2"	IPS	397.47
1466	76-608-01	2"	IPS	519.18

### 86A Series Stainless Steel Actuator Ready 3-Piece Full Port 1500 CWP NPT Ball Valve

- 3-Piece construction w/ enclosed fasteners
- Two-position locking
- Full port
- Adjustable multi-piece PTFE "V" style packing
- Stainless steel trim & hardware
- Fully machined ISO 5211 mounting
- Swing-out center section
- Cast bosses on the center-section and end caps
- Pressure balanced solid ball for bleed & drain ports
- Compression controlled RPTFE gaskets
- Vacuum service to 29 in of Hg
- Anti-blowout one piece bottom entry stem
- 150 psig saturated steam



#### 86A-100 Series (FNPT)

Part #	Mfg #	Size	Type	Price
884713	86A-103-01	1/2"	IPS	175.33
884714	86A-104-01	3/4"	IPS	252.87
884715	86A-105-01	1"	IPS	303.45
884716	86A-106-01	1-1/4"	IPS	354.02
884717	86A-107-01	1-1/2"	IPS	472.04
884719	86A-108-01	2"	IPS	623.77

#### 86A-200 Series (Socket Weld)

Part #	Mfg #	Size	Type	Price
884720	86A-203-01	1/2"	Socket Weld	155.17
884721	86A-204-01	3/4"	Socket Weld	175.33
884722	86A-205-01	1"	Socket Weld	252.87



## Ball Valves - Stainless Steel



### Apollo 316SS Ball Valves (Continued)

#### 86ASeries Stainless Steel Actuator Ready 3-Piece Full Port 1500 CWP NPT Ball Valve 86A-200 Series (Socket Weld)

Part #	Mfg #	Size	Type	Price
884723	86A-206-01	1-1/4"	Socket Weld	303.45
884725	86A-207-01	1-1/2"	Socket Weld	472.04
884726	86A-208-01	2"	Socket Weld	623.77

#### 87A Series Flanged 150# Stainless Steel Ball Valves

- ASME Class 150RF
- ANSI
- 2-position locking device
- CHV Style adjustable stem seals
- 4-Point ISO 5211 mounting pad bolt pattern
- Slot vented ball for thermal expansion
- Anti-static grounded ball & stem
- Blow-out proof stem design
- Cast boss for bleed/drain port
- Vacuum service to 29" of HG
- Pressure ratings:  
150 psig Saturated steam



#### 87A-100 Series Flanged Standard Port

Part #	Mfg #	Size	Type	Price
1619	87A-107-01A	1-1/2"	Flanged	722.77
1620	87A-108-01	2"	Flanged	899.62
1621	87A-109-01	2-1/2"	Flanged	1003.85
1622	87A-100-01	3"	Flanged	1435.52
1623	87A-10A-01	4"	Flanged	2038.17

#### 87A-100 Series Flanged Full Port



Part #	Mfg #	Size	Type	Price
33574	87A-207-01	1-1/2"	Flanged	970.32
1624	87A-208-01	2"	Flanged	1217.30
1625	87A-209-01	2-1/2"	Flanged	1552.40
1626	87A-200-01	3"	Flanged	1743.09
1627	87A-20A-01	4"	Flanged	2614.73

### 62-100 Series Stainless Steel Ball Cone Check Valves

- The 62-100 series is uniquely suited for applications in corrosive environments, including chemical processing, pulp and paper and other process industries.
- The rugged stainless steel body and RPTFE ball check provide reliable, patented protection against reverse flow.
- Features unique (U.S. Patent # 4,172,465) design provides tight shutoff in reverse flow conditions.
- The body of the valve is investment cast stainless steel for longer life in severe environments.
- Spring-loaded for fast seating action and center guided so that radial alignment is never needed.
- Straight-through flow minimizes velocity change.
- Rated 400 psig CWP, cold non-shock; 125 psig saturated steam.
- Also available in Bronze



Part #	Mfg #	Size	Type	Price
1302	62-101-01	1/4"	IPS	74.55
1303	62-102-01	3/8"	IPS	76.25
1304	62-103-01	1/2"	IPS	90.04
1305	62-104-01	3/4"	IPS	144.30
1306	62-105-01	1"	IPS	196.22
1307	62-106-01	1-1/4"	IPS	266.28
1308	62-107-01	1-1/2"	IPS	373.17
1309	62-108-01	2"	IPS	650.03



### Ball Valves

#### 3700 Cast Iron Full Port Flanged Ball Valve

- Epoxy-coated A126 Class B cast iron body
- Teflon®-fused solid ball
- Tapped and plugged boss allows for venting or draining downstream
- Class VI positive shut-off
- 100% Lead-free
- Low torque
- Ideal for liquid, air, backflow applications
- Rated 200W at 200° F
- Same end to end dimensions as gate valves for easy replacement



Part #	Mfg #	Size	Type	Price
187408	3700	2"	Flanged	185.54

Valves



## Ball Valves - Cast Iron



### Ball Valves (Continued)

#### 3700 Cast Iron Full Port Flanged Ball Valve

Part #	Mfg #	Size	Type	Price
187410	3700	2-1/2"	Flanged	193.81
187486	3700	3"	Flanged	215.85
187487	3700	4"	Flanged	307.70
187488	3700	6"	Flanged	505.18
187489	3700	8"	Flanged	900.14

#### 4000 Cast Iron Full Port Flanged Ball Valve

- FDA Food-grade epoxy coated
- A126 Class B cast iron
- Full port through 6"
- Teflon-fused solid ball
- Blow-out proof stain steel stem
- Reinforced Teflon® seats
- Lockable in full open or closed positions
- Mounting pad for easy actuation
- Adjustable length and removable handles
- 125 psi WSP, 200 psi WOG, 353° F
- Same end to end dimensions as gate valves for easy replacement



Part #	Mfg #	Size	Type	Price
1263	4000	2"	Flanged	237.48
1264	4000	2-1/2"	Flanged	243.87
1265	4000	3"	Flanged	276.75
1266	4000	4"	Flanged	398.23
1267	4000	6"	Flanged	653.97
1268	4000	8"	Flanged	1090.56



### PVC Ball Valves

#### Compact 2000 Ball Valves

- Pressure rating @ 73°F is 235 psi
- Maximum service temperature: 140°F
- Rated for vacuum service
- Assembled with silicone-free water-soluble lubricants
- Sealed unit, non-repairable



#### PVC 2000 Socket Ball Valves - EPDM

Part #	Mfg #	Size	Type	Price
886055	6622-005	1/2"	SxS MIP	20.11

Prices & specifications are subject to change.

### PVC Ball Valves (Continued)

#### Compact 2000 Ball Valves

#### PVC 2000 Socket Ball Valves - EPDM

Part #	Mfg #	Size	Type	Price
886056	6622-007	3/4"	SxS MIP	27.44
886057	6622-010	1"	SxS MIP	29.95
886059	6622-012	1-1/4"	SxS MIP	53.67
886060	6622-015	1-1/2"	SxS MIP	53.67
886061	6622-020	2"	SxS MIP	71.65

#### PVC 2000 TxT Ball Valves - EPDM

Part #	Mfg #	Size	Type	Price
886063	6621-005	1/2"	TxT MIP	20.11
886064	6621-007	3/4"	TxT MIP	27.44

### True Union Ball Check Valves

#### True Union 2000 Industrial Ball Check Valves

- Industrial grade
- Flow-tested for minimum turbulence
- Fully serviceable, replaceable components, uses standard O-ring seat
- NSF certified for potable water
- Low extractable PVC material
- Sizes 1/2" - 4" pressure rated to 235 psi at 73°F,



Part #	Mfg #	Size	Price
886041	4529-005	1/2"	42.41
886042	4529-007	3/4"	50.57
886043	4529-010	1"	60.14
886044	4529-012	1-1/4"	87.82
886045	4529-015	1-1/2"	100.87
886046	4529-020	2"	137.71



## Ball Valves - PVC & CPVC

### True Union Ball Valves

#### True Union 2000 Standard Ball Valves

- Pressure rating at 73°F, water for 1/2" - 2" is 235 psi
- Maximum service rating is 140°F
- Assembled with silicone-free, water-soluble lubricant



#### PVC TU 2000 Standard Threaded & Socket Ball Valve - EPDM Seals

Part #	Mfg #	Size	Price
886029	3629-005	1/2"	29.92
886032	3629-007	3/4"	35.39
886033	3629-010	1"	42.16
886034	3629-012	1-1/4"	58.30
886035	3629-015	1-1/2"	70.24
886036	3629-020	2"	92.69

#### PVC TU 2000 Standard Socket Ball Valve - EPDM Seals

Part #	Mfg #	Size	Price
886038	3622-030W	3"	296.54
886039	3622-040W	4"	500.88

### True Union Ball Valves - Regular Style

#### CPVC True Union Threaded & Socket Ball Valve - Viton®



Part #	Mfg #	Size	Price
886048	3629-005C	1/2"	39.49
886050	3629-007C	3/4"	49.76
886051	3629-010C	1"	59.24
886052	3629-012C	1-1/4"	94.18
887419	3629-015C	1-1/2"	99.44
886053	3629-020C	2"	133.01



## Pipe Fabrication Shop

Cutting, threading, grooving, make-on and welding - on site!

Valves



## Gate Valves - Bronze

### Bronze Gate Valves

#### T-113 125# Bronze Gate Valves (FNPT x FNPT)

- Screw-in bonnet
- Non-rising stem
- Solid wedge
- 200 psi non-shock cold working pressure

**NIBCO**  
AHEAD OF THE FLOW™



Part #	Mfg #	Size	Type	Price
2609	T-113	1/4"	IPS	37.16
2610	T-113	3/8"	IPS	37.16
2611	T-113	1/2"	IPS	34.31
2612	T-113	3/4"	IPS	40.59
2613	T-113	1"	IPS	51.46
2614	T-113	1-1/4"	IPS	78.32
2615	T-113	1-1/2"	IPS	90.33
2617	T-113	2"	IPS	108.62
2616	T-113	2-1/2"	IPS	308.14
2618	T-113	3"	IPS	379.60

#### S-113 125# Bronze Gate Valves (Sweat x Sweat)

- Screw-in bonnet
- Non-rising stem
- Solid wedge
- 200 psi non-shock cold working pressure

**NIBCO**  
AHEAD OF THE FLOW™



Part #	Mfg #	Size	Type	Price
2600	S-113	1/2"	C x C	32.59
2601	S-113	3/4"	C x C	37.16
2602	S-113	1"	C x C	52.60
2603	S-113	1-1/4"	C x C	80.61
2604	S-113	1-1/2"	C x C	90.33
2605	S-113	2"	C x C	128.06
2606	S-113	2-1/2"	C x C	320.14
2607	S-113	3"	C x C	418.47

### Bronze Gate Valves -125# - (FNPT)

- Screwed bonnet
- Solid wedge disc
- Full ports
- Integral bronze seat
- MSS specification SP-80
- Working pressures non-shock:  
125 psi Steam, basic rating  
200 psi cold working pressure

**CRANE**



#### 428 Series - Rising Stem

Part #	Mfg #	Size	Type	Price
921	428	1/4"	IPS	38.52
922	428	3/8"	IPS	39.45
923	428	1/2"	IPS	33.29
924	428	3/4"	IPS	40.90
925	428	1"	IPS	55.92
926	428	1-1/4"	IPS	82.13
927	428	1-1/2"	IPS	96.11
928	428	2"	IPS	122.32
929	428	2-1/2"	IPS	328.81
930	428	3"	IPS	446.23

#### 438 Series - Non-Rising Stem 125# - (FNPT)

- Full port
- Solid wedge disc
- Hand wheel actuation
- Non rising stem design
- Threaded bonnet
- ASTM B62 C83600 bronze alloy body material

**CRANE**

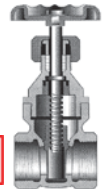

Part #	Mfg #	Size Type	Price
974	438	1/4" IPS	34.30
975	438	3/8" IPS	34.30
976	438	1/2" IPS	32.32
977	438	3/4" IPS	38.01
978	438	1" IPS	48.19
979	438	1-1/4" IPS	74.26
980	438	1-1/2" IPS	87.38
981	438	2" IPS	103.55
982	438	2-1/2" IPS	295.92
983	438	3" IPS	365.44



## Gate Valves - Bronze

### T-133 150# Bronze Non-Rising Stem Gate Valves (FNPT x FNPT)

- Block pattern
- Screw-in bonnet
- Non-rising stem
- Solid wedge
- 300 psi non-shock cold working pressure

**NIBCO**  
AHEAD OF THE FLOW™



Part #	Mfg #	Size	Type	Price
164212	T-133	1/4"	IPS	54.89
164214	T-133	3/8"	IPS	54.89
164215	T-133	1/2"	IPS	51.46
164216	T-133	3/4"	IPS	58.89
164217	T-133	1"	IPS	74.32
164218	T-133	1-1/4"	IPS	100.62
164219	T-133	1-1/2"	IPS	144.07
164220	T-133	2"	IPS	172.08
164221	T-133	2-1/2"	IPS	401.89
164222	T-133	3"	IPS	569.96

### 437 Bronze Gate Valves - 150# - Non-Rising Stem - (FNPT)

- Screwed bonnet
- Solid wedge disc
- Full ports
- Integral bronze seat
- MSS specification SP-80, Type 1
- Working pressures non-shock:  
150 psi steam, basic rating  
300 psi cold working pressure

**CRANE**

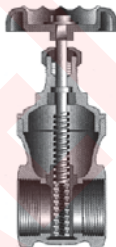

Part #	Mfg #	Size	Type	Price
964	437	1/4"	IPS	53.55
965	437	3/8"	IPS	54.02
966	437	1/2"	IPS	45.33
967	437	3/4"	IPS	51.92
968	437	1"	IPS	67.17
969	437	1-1/4"	IPS	96.77
970	437	1-1/2"	IPS	113.68
971	437	2"	IPS	146.56
972	437	2-1/2"	IPS	384.23
973	437	3"	IPS	543.94

### Bronze Gate Valves - 150# - (Solder Joint)

- Screwed 1-piece bonnet
- Solid wedge disc
- Full ports
- Integral bronze seat
- MSS Specification SP-80
- Working pressure non-shock:  
300 psi Cold working pressure

**CRANE**

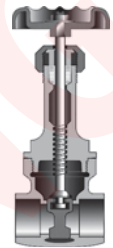

#### 1334 Series - Rising Stem

Part #	Mfg #	Size	Type	Price
1098	1334	1/2"	C x C	58.20
1099	1334	3/4"	C x C	63.46
1100	1334	1"	C x C	92.06
1101	1334	1-1/4"	C x C	127.84
1102	1334	1-1/2"	C x C	150.27
1103	1334	2"	C x C	244.25
1104	1334	2-1/2"	C x C	545.72
1105	1334	3"	C x C	770.88

#### 1324 Series - Non-Rising Stem

- Screwed bonnet
- Solid wedge disc
- Solder joint ends
- Full ports
- Back seat
- Integral bronze seat
- MSS-SP-80, type 1

**CRANE**

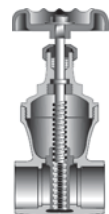

Part #	Mfg #	Size	Type	Price
1089	1324	3/8"	C x C	Call
1090	1324	1/2"	C x C	57.31
1091	1324	3/4"	C x C	62.49
1092	1324	1"	C x C	90.65
1093	1324	1-1/4"	C x C	125.88
1094	1324	1-1/2"	C x C	147.97
1095	1324	2"	C x C	240.51
1096	1324	2-1/2"	C x C	537.37
1097	1324	3"	C x C	759.07





## Gate Valves - Bronze

### T-134 150# Bronze Rising Stem Gate Valves (FNPT x FNPT)

- Block pattern
- Union bonnet
- Rising stem
- Solid wedge
- 300 psi Non-shock cold working pressure

**NIBCO**  
 AHEAD OF THE FLOW™



Part #	Mfg #	Size	Type	Price
164225	T-134	1/2"	IPS	49.74
164226	T-134	3/4"	IPS	58.89
164227	T-134	1"	IPS	74.32
164228	T-134	1-1/4"	IPS	114.91
164229	T-134	1-1/2"	IPS	141.78
164230	T-134	2"	IPS	172.08
164231	T-134	2-1/2"	IPS	404.75
164232	T-134	3"	IPS	559.67

### 431UB Bronze Gate Valves - 150# - Rising Stem - (FNPT)

- Union bonnet
- Solid wedge disc
- Full ports
- Integral bronze seat
- MSS Specification SP-80, Type 2
- Working pressures non-shock:  
 150 psi Steam, basic rating  
 300 psi Cold working pressure

**CRANE**

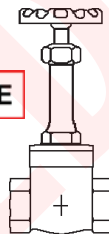

Part #	Mfg #	Size	Type	Price
946	431UB	1/4"	IPS	46.51
947	431UB	3/8"	IPS	48.85
948	431UB	1/2"	IPS	42.74
949	431UB	3/4"	IPS	50.27
950	431UB	1"	IPS	67.17
951	431UB	1-1/4"	IPS	94.42
952	431UB	1-1/2"	IPS	113.68
953	431UB	2"	IPS	155.00
954	431UB	2-1/2"	IPS	385.17
955	431UB	3"	IPS	532.66

### 424 Bronze Gate Valves - 200# - Rising Stem - (FNPT)

- Union bonnet
- Solid wedge disc
- Full ports
- Integral bronze seat
- MSS Specification SP-80, Type 2
- Working pressures non-shock:  
 200 psi Steam, basic rating  
 400 psi Cold working pressure

**CRANE**

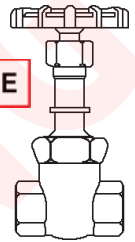

Part #	Mfg #	Size	Type	Price
901	424	1/4"	IPS	115.56
902	424	3/8"	IPS	100.53
903	424	1/2"	IPS	83.61
904	424	3/4"	IPS	97.72
905	424	1"	IPS	139.99
906	424	1-1/4"	IPS	230.17
907	424	1-1/2"	IPS	237.69
908	424	2"	IPS	345.70
909	424	2-1/2"	IPS	1022.12
910	424	3"	IPS	1449.57

### T-174-A 300# Bronze Gate Valves (FNPT x FNPT)

- Block pattern
- Union bonnet
- Rising stem
- Alloy solid wedge
- Disc alloy threads
- Integral seats
- 600 psi Non-shock cold working pressure

**NIBCO**  
 AHEAD OF THE FLOW™



Part #	Mfg #	Size	Type	Price
164233	T-174-A	1/4"	IPS	87.47
164234	T-174-A	3/8"	IPS	87.47
164235	T-174-A	1/2"	IPS	73.75
164236	T-174-A	3/4"	IPS	90.33
164237	T-174-A	1"	IPS	129.77
164238	T-174-A	1-1/4"	IPS	197.23
164239	T-174-A	1-1/2"	IPS	226.96
164240	T-174-A	2"	IPS	338.43



## Gate Valves - Bronze

### 634E Bronze Gate Valves - 300# - Rising Stem - (FNPT)

- Union bonnet
- Solid wedge disc
- Full ports
- Stainless steel seat rings
- Recommended for SWOG
- MSS Specification SP-80
- Working pressures non-shock:  
 300 psi Steam, basic rating  
 1/4" through 2" - 1000 psi Cold working pressure  
 2-1/2" through 3" - 600 psi Cold working pressure

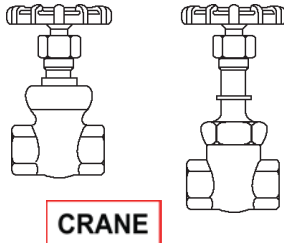

**CRANE**

Part #	Mfg #	Size	Type	Price
1064	634E	1/4"	IPS	128.71
1065	634E	3/8"	IPS	128.71
1066	634E	1/2"	IPS	78.92
1067	634E	3/4"	IPS	95.37
1068	634E	1"	IPS	134.34
1069	634E	1-1/4"	IPS	193.54
1070	634E	1-1/2"	IPS	225.45
1071	634E	2"	IPS	329.75
1072	634E	2-1/2"	IPS	1409.16
1073	634E	3"	IPS	1972.83

### 622E Bronze Gate Valves - 300# - Rising Stem - (FNPT)

- Union bonnet
- Solid wedge disc
- Full ports
- Recommended for SWOG
- MSS Specification SP-80, Type 2
- Working pressures non-shock:  
 300 psi Steam, basic rating  
 1/4" through 2" - 1000 psi Cold working pressure  
 2-1/2" through 3" - 600 psi Cold working pressure



**CRANE**

Part #	Mfg #	Size	Type	Price
158355	622E	1/4"	IPS	80.33
158356	622E	3/8"	IPS	80.33
158357	622E	1/2"	IPS	66.24
158358	622E	3/4"	IPS	76.11
158359	622E	1"	IPS	115.57
158360	622E	1-1/4"	IPS	185.07
158361	622E	1-1/2"	IPS	186.00
158362	622E	2"	IPS	282.78
158363	622E	2-1/2"	IPS	1033.39

### 636E Bronze Gate Valves - 300# - Non-Rising Stem - (FNPT)

- Union bonnet
- Solid wedge disc
- Full ports
- Back seat
- Stainless steel seat rings
- MSS Specifications SP-80, Type 1
- Working pressure non-shock:  
 300 psi Steam, basic rating  
 1000 psi Cold working pressure

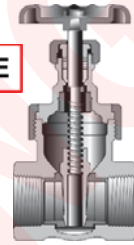

**CRANE**

Part #	Mfg #	Size	Type	Price
1074	636E	1/4"	IPS	208.01
1075	636E	3/8"	IPS	134.34
1076	636E	1/2"	IPS	208.01
1077	636E	3/4"	IPS	249.90
1078	636E	1"	IPS	298.75
1079	636E	1-1/4"	IPS	388.01
1080	636E	1-1/2"	IPS	406.78
1081	636E	2"	IPS	544.88

### T-113-HC 125# Bronze Gate Valves Hose End w/Cap & Chain

- Screw-in bonnet
- Non-rising stem
- Solid wedge
- Hose cap and chain
- 200 psi Non-shock cold working pressure



**NIBCO**  
AHEAD OF THE FLOW

Part #	Mfg #	Size	Type	Price
164211	T-113-HC	3/4"	IPS	211.52

### T-104-O 175# Bronze Gate Valves

- Fire protection valve
- Block pattern
- Screw-over bonnet
- Outside screw and yoke
- Solid wedge
- 175 PSI/12.1 Bar non-shock cold water



**NIBCO**  
AHEAD OF THE FLOW

Part #	Mfg #	Size	Type	Price
160436	T-104-O	1"	IPS	178.69
2596	T-104-O	1-1/4"	IPS	206.69
2597	T-104-O	1-1/2"	IPS	266.03
2598	T-104-O	2"	IPS	346.71

Valves



## Gate Valves - Bronze

### 429 Bronze Gate Valves - 150# - Rising Stem (Flanged)

- Screwed bonnet
- Solid wedge disc
- Flanged ends are plain faced with (2) V-shaped concentric grooves between the port and bolt holes
- Full ports
- Integral bronze seat
- MSS Specifications SP-80, Type 2
- Working pressures non-shock:  
 150 psi steam, basic rating  
 235 psi cold working pressure

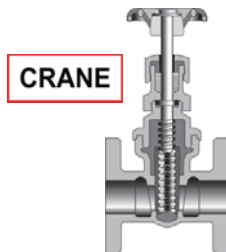

Part #	Mfg #	Size	Type	Price
931	429	1"	Flanged	739.35
932	429	1-1/2"	Flanged	920.66
933	429	2"	Flanged	1357.50
934	429	2-1/2"	Flanged	2094.94
935	429	3"	Flanged	2442.55

### Bronze Globe Valves

#### 1 Bronze Globe Valves - 125# - Rising Stem - (FNPT)

- Threaded bonnet
- Integral bronze seat
- MSS Specification SP-80, Type 1
- Working pressures non-shock:  
 125 psi Steam, basic rating  
 200 psi Cold working pressure

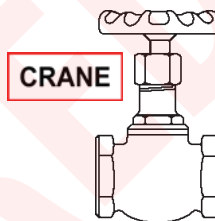

Part #	Mfg #	Size	Type	Price
600	1	3/8"	IPS	69.07
601	1	1/2"	IPS	56.35
602	1	3/4"	IPS	65.55
603	1	1"	IPS	94.47
604	1	1-1/4"	IPS	138.14
605	1	1-1/2"	IPS	157.43
606	1	2"	IPS	233.10
607	1	2-1/2"	IPS	Call
608	1	3"	IPS	Call

### 1310 Bronze Globe Valves - 150# (Solder End)

- Screwed bonnet
- Solder joint ends
- Integral bronze seat
- Back seat
- PTFE disc
- MSS SP-80, type 2
- 300 psi cold working pressure

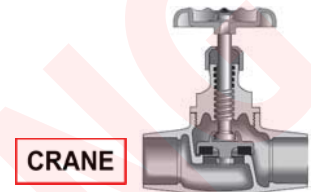

Part #	Mfg #	Size	Type	Price
1082	1310	3/8"	Copper	Call
1083	1310	1/2"	Copper	90.19
1084	1310	3/4"	Copper	134.34
1085	1310	1"	Copper	173.80
1086	1310	1-1/4"	Copper	277.15
1087	1310	1-1/2"	Copper	325.98
1088	1310	2"	Copper	497.90

### 7TF Bronze Globe Valves - 150# - Rising Stem - (FNPT)

- PTFE disc
- 2" and smaller - union bonnets, disc holder retains disc and slips on stem
- 2-1/2" and 3" - bolted bonnets, disc holder is fastened by a disc stem ring
- Integral bronze seat
- MSS Specification SP-80, Type 2
- Working pressures non-shock:  
 150 psi Steam, basic rating  
 300 psi Cold working pressure

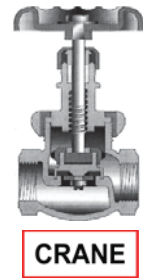

Part #	Mfg #	Size Type	Price
612	7TF	1/4" IPS	64.82
613	7TF	3/8" IPS	64.82
614	7TF	1/2" IPS	61.07
615	7TF	3/4" IPS	82.21
616	7TF	1" IPS	128.71
617	7TF	1-1/4" IPS	216.07
618	7TF	1-1/2" IPS	245.20
619	7TF	2" IPS	370.15
620	7TF	2-1/2" IPS	845.49
621	7TF	3" IPS	1202.49

Valves



## Globe Valves - Bronze

### T-235-Y 150# Bronze Globe Valves (FNPT x FNPT)

- Union bonnet
- Integral seat
- Renewable seat and disc
- 300 psi Non-shock cold working pressure

**NIBCO**  
AHEAD OF THE FLOW™



Part #	Mfg #	Size	Type	Price
164282	T-235-Y	1/2"	IPS	67.46
215184	T-235-Y	3/4"	IPS	90.90
164284	T-235-Y	1"	IPS	142.35
164285	T-235-Y	1-1/4"	IPS	226.96
164286	T-235-Y	1-1/2"	IPS	275.55
164287	T-235-Y	2"	IPS	413.32

### 14-1/2P Bronze Globe Valves - 150# - Stainless Steel Disc - (FNPT)

- Union bonnet, 1/4" through 2"
- Bolted bonnet, 2-1/2" and 3"
- Stainless steel seat ring
- MSS Specifications SP-80, Type 3
- Working pressure non-shock:  
150 psi Steam, basic rating  
300 psi Cold working pressure

**CRANE**

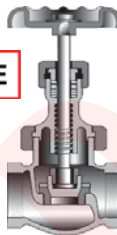

Part #	Mfg #	Size	Type	Price
631	14-1/2P	1/4"	IPS	138.11
632	14-1/2P	3/8"	IPS	140.92
633	14-1/2P	1/2"	IPS	130.58
634	14-1/2P	3/4"	IPS	175.68
635	14-1/2P	1"	IPS	222.64
636	14-1/2P	1-1/4"	IPS	325.05
637	14-1/2P	1-1/2"	IPS	409.60
638	14-1/2P	2"	IPS	683.96
639	14-1/2P	2-1/2"	IPS	1387.55
640	14-1/2P	3"	IPS	1917.70

### 212P Bronze Globe Valves - 200# - Rising Stem - (FNPT)

- Union bonnet
- Tapered plug type disc
- Stainless steel seat ring
- Disc and seat ring are renewable
- MSS Specification SP-80, Type 3
- Working pressures non-shock:  
200 psi Steam, basic rating  
400 psi Cold working pressure

**CRANE**

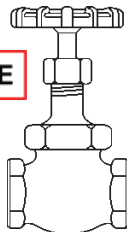

Part #	Mfg #	Size	Type	Price
816	212P	1/4"	IPS	103.39

### Bronze Globe Valves (Continued)

#### 212P Bronze Globe Valves - 200# - Rising Stem - (FNPT)

Part #	Mfg #	Size	Type	Price
817	212P	3/8"	IPS	110.92
818	212P	1/2"	IPS	108.99
819	212P	3/4"	IPS	147.50
820	212P	1"	IPS	186.00
821	212P	1-1/4"	IPS	251.71
822	212P	1-1/2"	IPS	353.61
823	212P	2"	IPS	537.97
824	212P	2-1/2"	IPS	1130.64
825	212P	3"	IPS	1772.54

#### T-275-B 300# Bronze Globe Valves (FNPT x FNPT)

- Union bonnet
- Integral seat
- Renewable seat and disc
- 600 psi Non-shock cold working pressure

**NIBCO**  
AHEAD OF THE FLOW™



Part #	Mfg #	Size	Type	Price
164293	T-275-B	1/2"	IPS	74.32
164294	T-275-B	3/4"	IPS	109.19
164295	T-275-B	1"	IPS	163.50
164296	T-275-B	1-1/4"	IPS	254.63
164297	T-275-B	1-1/2"	IPS	301.85
164298	T-275-B	2"	IPS	451.63

#### 382P Bronze Globe Valves - 300# - Rising Stem - (FNPT)

- Union bonnet
- Plug type disc
- 450 Brinell hardened stainless steel seat ring
- 2" and smaller have compact union bonnet
- 2-1/2" and 3" use bolted bonnet
- MSS Specification SP-80, Type 3
- Working pressures non-shock:  
300 psi Steam, basic rating  
1/4" through 2" - 1000 psi Cold working pressure  
2-1/2" through 3" - 600 psi Cold working pressure

**CRANE**

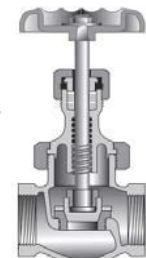

Part #	Mfg #	Size	Type	Price
877	382P	1/4"	IPS	129.20
878	382P	3/8"	IPS	129.20
879	382P	1/2"	IPS	117.44
880	382P	3/4"	IPS	160.65
881	382P	1"	IPS	191.64

Prices & specifications are subject to change.

Valves



## Globe Valves - Bronze

### Bronze Globe Valves (Continued)

#### 382P Bronze Globe Valves - 300# - Rising Stem - (FNPT)

Part #	Mfg #	Size	Type	Price
882	382P	1-1/4"	IPS	385.96
883	382P	1-1/2"	IPS	442.82
884	382P	2"	IPS	602.20
885	382P	2-1/2"	IPS	1127.32
886	382P	3"	IPS	1878.90

#### 17TF Bronze Angle Valves - 150# - Rising Stem - (FNPT)

- Union bonnet
- Integral bronze seat
- PTFE disc
- MSS Specification SP-80, Type 2
- Working pressures non-shock:  
150 psi Steam, basic rating  
300 psi Cold working pressure

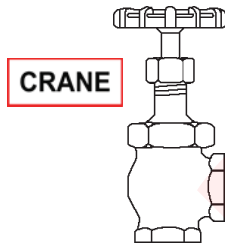

Part #	Mfg #	Size	Type	Price
642	17TF	3/8"	IPS	88.32
641	17TF	1/4"	IPS	88.32
643	17TF	1/2"	IPS	88.32
644	17TF	3/4"	IPS	115.56
645	17TF	1"	IPS	166.29
646	17TF	1-1/4"	IPS	221.71
647	17TF	1-1/2"	IPS	280.91
648	17TF	2"	IPS	464.07

#### 384P Bronze Angle Valves - 300# - Rising Stem - (FNPT)

- Union bonnet
- Stainless steel plug type disc
- Wide seating surfaces
- 450 Brinell hardened stainless steel seat ring
- Backseat
- MSS Specification SP-80, Type 3
- Working pressures non-shock:  
300 psi Steam, basic rating  
1000 psi Cold working pressure

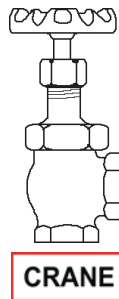

Part #	Mfg #	Size Type	Price
893	384P	1/4" IPS	155.27
894	384P	3/8" IPS	155.27
895	384P	1/2" IPS	167.38
896	384P	3/4" IPS	261.65
897	384P	1" IPS	335.58
898	384P	1-1/4" IPS	Call

### Bronze Globe Valves (Continued)

#### 384P Bronze Angle Valves - 300# - Rising Stem - (FNPT)

Part #	Mfg #	Size Type	Price
899	384P	1-1/2" IPS	589.10
900	384P	2" IPS	901.90

#### Bronze Lever Globe Valves - 150# - (FNPT)

- Fast opening and self-closing
- Non-metallic, resilient Teflon® disc
- Stainless steel spring
- Pressures: 150 psi SP; 150 psi WOG

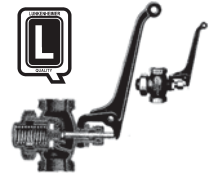

1836 Series - Pull Lever

Part #	Mfg #	Size	Type	Price
1869	1836	1/4"	IPS	204.63
1870	1836	3/8"	IPS	204.63
1871	1836	1/2"	IPS	204.63
1872	1836	3/4"	IPS	286.49
1873	1836	1"	IPS	337.23
1874	1836	1-1/4"	IPS	478.02
1875	1836	1-1/2"	IPS	582.79
1876	1836	2"	IPS	795.61

#### 1837 Series - Grip Lever

Part #	Mfg #	Size	Type	Price
1877	1837	1/4"	IPS	204.63
1878	1837	3/8"	IPS	204.63
1879	1837	1/2"	IPS	204.63
1880	1837	3/4"	IPS	286.49

#### 325U - Y-Blow Down Valves - 300# - Rising Stem - (FNPT)

- Bronze body
- Swivel disc holder
- Stainless steel seat & disc
- Complies with MSS-SP-80-97
- Pressure non-shock: 300 WSP, 600 WOG



Part #	Mfg #	Size	Type	Price
48712	325U	1"	IPS	345.07
48714	325U	1-1/4"	IPS	405.26
48715	325U	1-1/2"	IPS	484.13
48719	325U	2"	IPS	777.91

Prices & specifications are subject to change.

We offer a variety of GREEN products such as flush valves, faucets, showerheads & more!



## Globe Valves - Bronze

### 180-T Bronze Blow-Off Valves - 300# - Y-Pattern - (FNPT)

- Union bonnet
- Teflon® disc
- Integral bronze seat ring
- ASTM B61 Type S-1
- Pressure: 300 psi SP



**LUNKENHEIMER**

Part #	Mfg #	Size	Type	Price
118134	180-T	1"	IPS	401.08
118137	180-T	1-1/4"	IPS	484.57
118138	180-T	1-1/2"	IPS	636.82
118139	180-T	2"	IPS	918.39

### Bronze Check Valves

#### S-413-B 125# Bronze Check Valves (Sweat x Sweat)

- Horizontal swing
- Re grinding type
- Y-Pattern
- Renewable seat and disc
- 200 psi Non-shock cold working pressure



**NIBCO**  
AHEAD OF THE FLOW™

C x C

Part #	Mfg #	Size	Type	Price
164376	S-413-B	1/2"	C x C	47.45
164377	S-413-B	3/4"	C x C	64.03
164378	S-413-B	1"	C x C	92.04
164379	S-413-B	1-1/4"	C x C	133.21
164380	S-413-B	1-1/2"	C x C	154.93
164381	S-413-B	2"	C x C	228.10

IPS

Part #	Mfg #	Size	Type	Price
164311	T-413-B	1/4"	IPS	44.02
164312	T-413-B	3/8"	IPS	44.02
164313	T-413-B	1/2"	IPS	42.88
164314	T-413-B	3/4"	IPS	51.46
164360	T-413-B	1"	IPS	70.32
164361	T-413-B	1-1/4"	IPS	97.19
164362	T-413-B	1-1/2"	IPS	116.05
164363	T-413-B	2"	IPS	166.36

### T-433-B 150# Bronze Check Valves (FNPT x FNPT)

- Horizontal swing
- Re grinding type
- Y-Pattern
- Renewable seat and disc
- 300 psi Non-shock cold working pressure

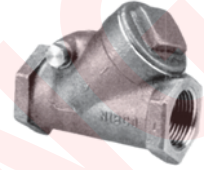

**NIBCO**  
AHEAD OF THE FLOW™

Part #	Mfg #	Size	Type	Price
164548	T-433-B	1/4"	IPS	62.32
164549	T-433-B	3/8"	IPS	62.32
164550	T-433-B	1/2"	IPS	61.17
164551	T-433-B	3/4"	IPS	73.75
164552	T-433-B	1"	IPS	99.48
164553	T-433-B	1-1/4"	IPS	131.49
164554	T-433-B	1-1/2"	IPS	170.94
164555	T-433-B	2"	IPS	255.54
164556	T-433-B	2-1/2"	IPS	388.74
164557	T-433-B	3"	IPS	569.96

### S-433-B 150# Bronze Check Valves (Sweat x Sweat)

- Bolted bonnet
- Horizontal swing
- Re grinding type
- Y-Pattern
- Renewable seat and disc
- 300 psi Non-shock cold working pressure



**NIBCO**  
AHEAD OF THE FLOW™

Part #	Mfg #	Size	Type	Price
186639	S-433-B	2"	C x C	280.97
164382	S-433-B	2-1/2"	C x C	511.65
139053	S-433-B	3"	C x C	682.01
226705	S-433-B	4"	C x C	2748.24

### 37 Bronze Swing Check Valves - 125# - Y-Pattern - (FNPT)

- Y-Pattern body with integral seat
- Always install with pressure under the disc in vertical or horizontal position
- Screwed cap
- MSS Specification SP-80
- Working pressures non-shock:  
125 psi Steam, basic rating  
200 psi Cold working pressure

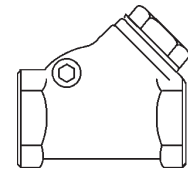

**CRANE**

Part #	Mfg #	Size	Type	Price
711	37	1/4"	IPS	39.45
712	37	3/8"	IPS	39.45

Prices & specifications are subject to change.



## Check Valves - Bronze

### Bronze Check Valves (Continued)

#### 37 Bronze Swing Check Valves - 125# - Y-Pattern - (FNPT)

Part #	Mfg #	Size	Type	Price
713	37	1/2"	IPS	36.17
714	37	3/4"	IPS	45.80
715	37	1"	IPS	62.94
716	37	1-1/4"	IPS	86.43
717	37	1-1/2"	IPS	99.13
718	37	2"	IPS	147.50
719	37	2-1/2"	IPS	371.08
720	37	3"	IPS	549.58

#### 137 Bronze Swing Check Valves - 150# - Y-Pattern - (FNPT)

- Free-to-rotate disc design allows disc to close in different position on the integral seat each time it operates
- Always install with pressure under the disc in vertical or horizontal position
- Screwed cap
- MSS Specification SP-80, Type 3
- Working pressures non-shock:  
150 psi Steam, basic rating  
300 psi Cold working pressure

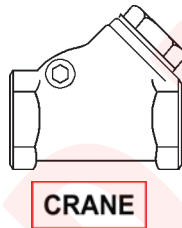

Part #	Mfg #	Size	Type	Price
775	137	1/4"	IPS	64.19
776	137	3/8"	IPS	64.19
777	137	1/2"	IPS	57.31
778	137	3/4"	IPS	71.39
779	137	1"	IPS	96.77
780	137	1-1/4"	IPS	134.89
781	137	1-1/2"	IPS	165.34
782	137	2"	IPS	246.14
783	137	2-1/2"	IPS	461.51
784	137	3"	IPS	596.55

#### 1342 Bronze Swing Check Valves - 150# - Y-Pattern - (Solder Joint)

- Always install with pressure under the disc horizontal position
- Screwed cap
- MSS Specification SP-80, Type 3
- Working pressures non-shock:  
300 psi Cold working pressure

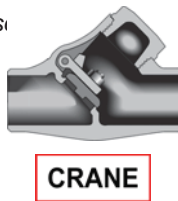

Part #	Mfg #	Size	Type	Price
1106	1342	1/2"	C x C	77.05
1107	1342	3/4"	C x C	92.07

### Bronze Check Valves (Continued)

#### 1342 Bronze Swing Check Valves - 150# - Y-Pattern - (Solder Joint)

Part #	Mfg #	Size	Type	Price
1108	1342	1"	C x C	134.34
1109	1342	1-1/4"	C x C	179.44
1110	1342	1-1/2"	C x C	230.17
1111	1342	2"	C x C	341.01
1112	1342	2-1/2"	C x C	568.38
1113	1342	3"	C x C	883.07

#### 36 Bronze Swing Check Valves - 200# - Y-Pattern - (FNPT)

- Rotating disc virtually eliminates "spot" seat wear
- Always install with pressure under the disc in vertical or horizontal position
- Screwed cap
- MSS Specification SP-80, Type 3
- Working pressures non-shock:  
200 psi Steam, basic rating  
400 psi Cold working pressure

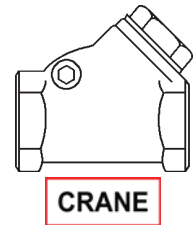

Part #	Mfg #	Size	Type	Price
701	36	1/4"	IPS	64.82
702	36	3/8"	IPS	64.82
703	36	1/2"	IPS	59.66
704	36	3/4"	IPS	75.15
705	36	1"	IPS	97.72
706	36	1-1/4"	IPS	139.51
707	36	1-1/2"	IPS	178.50
708	36	2"	IPS	257.41
709	36	2-1/2"	IPS	544.88
710	36	3"	IPS	826.70

#### 76E Bronze Swing Check Valves - 300# - Y-Pattern - (FNPT)

- Always install with pressure under the disc in vertical or horizontal position
- Screwed cap
- MSS Specification SP-80, Type 3
- Working pressures non-shock:  
300 psi Steam, basic rating  
1/4" through 2" - 1000 psi Cold working pressure  
2-1/2" through 3" - 600 psi Cold working pressure

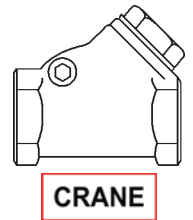

Part #	Mfg #	Size	Type	Price
744	76E	1/4"	IPS	69.99
745	76E	3/8"	IPS	69.99
746	76E	1/2"	IPS	62.94
747	76E	3/4"	IPS	78.45

Prices & specifications are subject to change.

Our state of the art pipe shop offers cutting, threading, grooving and make-ons up to 36in!



## Check Valves - Bronze

### Bronze Check Valves (Continued)

#### 76E Bronze Swing Check Valves - 300# - Y-Pattern - (FNPT)

Part #	Mfg #	Size	Type	Price
748	76E	1"	IPS	127.56
749	76E	1-1/4"	IPS	137.17
750	76E	1-1/2"	IPS	181.78
751	76E	2"	IPS	281.85
752	76E	2-1/2"	IPS	1019.30
753	76E	3"	IPS	1784.94

#### T-473-B 300# Bronze Check Valves (FNPT x FNPT)

- Horizontal swing
- Re grinding type
- Y-Pattern
- Renewable seat and disc
- 600 psi Non-shock cold working pressure



**NIBCO**  
AHEAD OF THE FLOW™

Part #	Mfg #	Size	Type	Price
164368	T-473-B	1/2"	IPS	73.38
164369	T-473-B	3/4"	IPS	92.20
164370	T-473-B	1"	IPS	122.93
164372	T-473-B	1-1/2"	IPS	206.97
164373	T-473-B	2"	IPS	305.28

#### T-413-Y 125# Bronze Check Valves (FNPT x FNPT) Soft Seat

- Horizontal swing
- Re grinding type
- Y-Pattern
- Renewable steam seat and disc
- 200 psi Non-shock cold working pressure



**NIBCO**  
AHEAD OF THE FLOW™

Part #	Mfg #	Size	Type	Price
2640	T-413-Y	1/2"	IPS	45.74
2641	T-413-Y	3/4"	IPS	53.17
2642	T-413-Y	1"	IPS	73.75
2643	T-413-Y	1-1/4"	IPS	105.19
2644	T-413-Y	1-1/2"	IPS	122.34
2645	T-413-Y	2"	IPS	178.94

#### T-433-Y 150# Bronze Check Valves (FNPT x FNPT) Soft Seat

- Horizontal swing
- Re grinding type
- Y-Pattern
- Renewable steam seat and disc
- 300 psi Non-shock cold working pressure

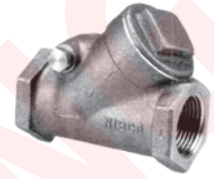

**NIBCO**  
AHEAD OF THE FLOW™

Part #	Mfg #	Size	Type	Price
185175	T-433-Y	1/2"	IPS	64.60
192023	T-433-Y	3/4"	IPS	Call
192025	T-433-Y	1"	IPS	Call
212801	T-433-Y	1-1/4"	IPS	117.69
192026	T-433-Y	1-1/2"	IPS	Call
896608	T-433-Y	2"	IPS	97.48
164365	T-433-Y	2-1/2"	IPS	391.60
161099	T-433-Y	3"	IPS	580.25

#### 27TF Bronze Horizontal Lift Check Valves - 150# - (FNPT)

- Union cap
- Disc holder is guided top and bottom on sizes 1/2" and larger
- PTFE disc suitable for steam service
- MSS Specification SP-80, Type 2
- Working pressures non-shock:  
150 psi Steam, basic rating  
300 psi Cold working pressure

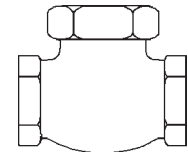

**CRANE**

Part #	Mfg #	Size	Type	Price
654	27TF	1/4"	IPS	167.21
655	27TF	3/8"	IPS	167.21
656	27TF	1/2"	IPS	147.50
657	27TF	3/4"	IPS	153.14
658	27TF	1"	IPS	189.77
659	27TF	1-1/2"	IPS	313.78
660	27TF	2"	IPS	455.63
661	27TF	2-1/2"	IPS	3538.80
662	27TF	3"	IPS	3195.55





## Check Valves - Bronze

### 366E Bronze Lift Check Valves - 300# - (FNPT)

- MSS Specification SP-80, Type 1
- Working pressures non-shock:  
 300 psi Steam, basic rating  
 1000 psi Cold working pressure

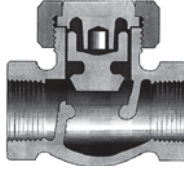

**CRANE**

Part #	Mfg #	Size	Type	Price
850	366E	1/2"	IPS	144.68
851	366E	3/4"	IPS	174.73
852	366E	1"	IPS	319.41
853	366E	1-1/4"	IPS	426.51
854	366E	1-1/2"	IPS	462.21
855	366E	2"	IPS	595.60

### 1616 Bronze Horizontal Lift Check Valves - 300# - (FNPT)

- Air compressor valve; suited to many air and gas line applications where there is frequent and rapid reversal of flow
- Bronze disc
- Stainless steel spring
- Pressure: 300 psi air

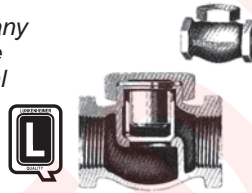

**LUNKENHEIMER**

Part #	Mfg #	Size	Type	Price
1863	1616	1/2"	IPS	365.06
1864	1616	3/4"	IPS	476.38
1865	1616	1"	IPS	551.69
1866	1616	1-1/4"	IPS	697.39
1867	1616	1-1/2"	IPS	885.65
1868	1616	2"	IPS	1208.15

### 50T - Spring Loaded Lift Check Valves - 200# - (FNPT)

- Bronze body
- PTFE Disc
- Integral Seat
- Maximum pressure:  
 200 WSP @ 406°F, 400 WOG



Part #	Mfg #	Size	Type	Price
1173	50T	1/4"	IPS	36.25
1174	50T	3/8"	IPS	49.72
1175	50T	1/2"	IPS	51.03
1176	50T	3/4"	IPS	62.77
1177	50T	1"	IPS	95.55
1178	50T	1-1/4"	IPS	120.86
1179	50T	1-1/2"	IPS	191.13

### Bronze Check Valves (Continued)

#### 50T - Spring Loaded Lift Check Valves - 200# - (FNPT)

Part #	Mfg #	Size	Type	Price
1180	50T	2"	IPS	280.77

#### 418 Bronze Vertical Lift Check Valves - 200# - (FNPT)

- Designed for non-return control where pulsating action is present in general service use
- Integral seats
- Pressures: 200 psi SP @ 550°F;  
 400 psi WOG

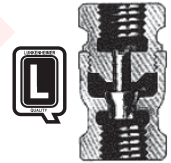

**LUNKENHEIMER**

Part #	Mfg #	Size	Type	Price
46438	418	1/2"	IPS	155.84
46436	418	3/4"	IPS	136.53
213203	418	1"	IPS	175.17
128785	418	1-1/4"	IPS	230.83
49749	418	2"	IPS	468.20

#### 29 Bronze Vertical Lift Check Valves - 125# - Bronze Disc - (FNPT)

- 1-Piece body with bronze disc
- For operation on upward flow only
- Always install vertically with pressure below the seat and inlet end down
- MSS Specification SP-80, Type 1
- Working pressure non-shock:  
 125 psi Steam, basic rating  
 200 psi Cold working pressure



**CRANE**

Part #	Mfg #	Size	Type	Price
667	29	1/4"	IPS	77.08
668	29	3/8"	IPS	77.96
669	29	1/2"	IPS	93.91
670	29	3/4"	IPS	44.19
671	29	1"	IPS	160.35
672	29	1-1/4"	IPS	224.15
673	29	1-1/2"	IPS	295.31
674	29	2"	IPS	428.78
675	29	2-1/2"	IPS	954.06
676	29	3"	IPS	1335.68

Prices & specifications are subject to change.



## Check Valves - Bronze

### S-480-Y 125# Bronze Inline Check Valves (Sweat x Sweat)

- Inline lift type
- TFE Seat and resilient steam discs
- Spring actuated
- 250 psi Non-shock cold working pressure



**NIBCO**  
AHEAD OF THE FLOW™

Part #	Mfg #	Size	Type	Price
2646	S-480-Y	1/2"	C x C	33.73
2647	S-480-Y	3/4"	C x C	36.59
2648	S-480-Y	1"	C x C	48.03
2649	S-480-Y	1-1/4"	C x C	61.17
2650	S-480-Y	1-1/2"	C x C	70.89
2651	S-480-Y	2"	C x C	108.62

### 61-100 Series Bronze Ball Cone Check Valves

- Well-suited for a broad range of applicator 125 psig saturated steam
- The rugged bronze body and RPTFE ball check provide reliable, patented protection against reverse flow
- Unique (U.S. Patent # 4,172,465) design provides tight shutoff in reverse flow conditions
- Spring-loaded for fast seating action and center guided so that radial alignment is never needed
- Straight-through flow minimizes velocity change
- Rated 400 psig CWP, cold non-shock
- Also available in Stainless Steel - See #62-100 series



**Apollo Valves**  
MADE IN THE USA

Part #	Mfg #	Size	Type	Price
1284	61-101-01	1/4"	IPS	36.39
1285	61-102-01	3/8"	IPS	36.39
1286	61-103-01	1/2"	IPS	36.39
1287	61-104-01	3/4"	IPS	51.67
1288	61-105-01	1"	IPS	71.05
1289	61-106-01	1-1/4"	IPS	123.72
1290	61-107-01	1-1/2"	IPS	157.89
1291	61-108-01	2"	IPS	257.00
1292	61-109-01	2-1/2"	IPS	556.27
1293	61-100-01	3"	IPS	877.07

### 61-500 Series Bronze Check Valves

- Ideally suited for hydronic heating and other low flow applications, since seat disc and EPDM soft seat are less prone to vibration
- The rugged bronze body and check provide reliable protection against reverse flow
- The 61-500/61-600 features an EPM soft seat for bubble tight shutoff, reduced noise and less vibration
- Spring-loaded for fast seating action and center guided so that radial alignment is never needed
- Straight-through flow minimizes velocity change
- Rated 400 psig CWP, cold non-shock; Maximum Temperature 250°F



**Apollo Valves**  
MADE IN THE USA

Part #	Mfg #	Size	Type	Price
1294	61-501-01	1/4"	IPS	35.73
1295	61-502-01	3/8"	IPS	23.08
1296	61-503-01	1/2"	IPS	35.73
1297	61-504-01	3/4"	IPS	50.34
1298	61-505-01	1"	IPS	71.26
1299	61-506-01	1-1/4"	IPS	120.09
1300	61-507-01	1-1/2"	IPS	156.66
1301	61-508-01	2"	IPS	263.26



## Custom Reporting

Need a year's worth of your purchase history? No problem! Our custom reporting capabilities allow us to get you the information you need – quickly.



## Gate Valves - Iron

### Iron Body Gate Valves

#### F-617-O 125# Iron OS&Y Gate Valves (Flange x Flange)

- Bolted bonnet
- Outside screw & yoke
- Solid wedge
- Bronze mounted
- 200 psi Non-shock cold working pressure

**NIBCO**  
 AHEAD OF THE FLOW™



Part #	Mfg #	Size	Type	Price
164386	F-617-O	2"	Flanged	298.42
164387	F-617-O	2-1/2"	Flanged	307.56
164388	F-617-O	3"	Flanged	337.29
164390	F-617-O	4"	Flanged	482.50
164399	F-617-O	5"	Flanged	795.20
163827	F-617-O	6"	Flanged	795.20
163826	F-617-O	8"	Flanged	1415.46
164391	F-617-O	10"	Flanged	2028.85
164392	F-617-O	12"	Flanged	Call
237944	F-617-O	14"	Flanged	Call
234527	F-617-O	16"	Flanged	Call
234528	F-617-O	18"	Flanged	Call
799878	F-617-O	20"	Flanged	Call
234529	F-617-O	24"	Flanged	Call

#### 465-1/2 Iron Gate Valves - 125# - Outside Screw & Yoke - Rising Stem - (Flanged)

- Bronze trim
- Tapered solid wedge disc
- Body guide ribs
- Renewable bronze seat rings
- Stem provide with ACME double threads for valves 24" and smaller ACME single thread for 30" and 36" valves
- Non-asbestos packing and gaskets
- MSS-SP-70 Type 1 and MSS-SP-25
- ANSI B16.10, ANSI B16.1
- Working pressures non-shock:
  - 125 psi Steam, basic rating
  - 200 psi Cold working pressure

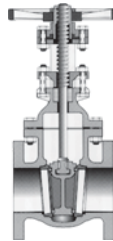

**CRANE**

Part #	Mfg #	Size	Type	Price
1008	465-1/2	2"	Flanged	312.43
1009	465-1/2	2-1/2"	Flanged	323.01
1026	465-1/2	3"	Flanged	441.72
1027	465-1/2	4"	Flanged	646.93
1012	465-1/2	5"	Flanged	853.53

### Iron Body Gate Valves (Continued)

#### 465-1/2 Iron Gate Valves - 125# - Outside Screw & Yoke - Rising Stem - (Flanged)

Part #	Mfg #	Size	Type	Price
1013	465-1/2	6"	Flanged	853.53
1014	465-1/2	8"	Flanged	1520.71
1015	465-1/2	10"	Flanged	2380.49
1016	465-1/2	12"	Flanged	3728.83

#### 461 Iron Gate Valves - 125# - Non-Rising Stem (Flanged)

- Bronze trim
- Tapered solid wedge disc
- Body guide ribs
- Renewable bronze seat rings
- Stem provide with ACME double threads for valves 24" and smaller; ACME single thread for 30" valves
- Non-asbestos packing and gaskets
- MSS-SP-70 Type 1 and MSS-SP-25
- ANSI B16.10, ANSI B16.1
- Working pressures non-shock:
  - 125 psi Steam, basic rating
  - 200 psi Cold working pressure

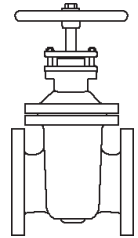

**CRANE**

Part #	Mfg #	Size	Type	Price
998	461	2-1/2"	Flanged	329.91
999	461	3"	Flanged	370.98
1000	461	4"	Flanged	522.70
1001	461	5"	Flanged	895.40
1002	461	6"	Flanged	895.40
1003	461	8"	Flanged	1520.71
47886	461	10"	Flanged	2776.84

#### 488 Iron Gate Valves - 125#-150# - Clamp Gate - Inside Screw - Rising Stem - (FNPT)

- Anti-clogging bonnet
- Nickel plated steel stem
- Malleable iron disc
- Steel U-Bolt clamp
- Body and bonnet malleable iron
- Integral seats
- Non-asbestos packing and gaskets
- ANSI/ASME B1.20.1

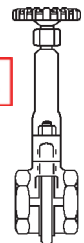

**CRANE**

Part #	Mfg #	Size	Type	Price
1038	488	1/4"	IPS	148.17
1039	488	3/8"	IPS	148.17
1040	488	1/2"	IPS	130.22

Prices & specifications are subject to change.

Metropolitan Pipe offers Vendor Managed Inventory - never run out of that part again!



## Gate Valves - Iron

### Iron Body Gate Valves (Continued)

#### 488 Iron Gate Valves - 125#-150# - Clamp Gate - Inside Screw - Rising Stem - (FNPT)

Part #	Mfg #	Size	Type	Price
1041	488	3/4"	IPS	131.60
1042	488	1"	IPS	133.90
1043	488	1-1/4"	IPS	174.85
1044	488	1-1/2"	IPS	183.13
1045	488	2"	IPS	262.73
1046	488	2-1/2"	IPS	434.82
1047	488	3"	IPS	523.62

#### 488-1/2 Series Flanged Iron Gate Valves

Part #	Mfg #	Size	Type	Price
1048	488-1/2	1"	Flanged	277.46
1049	488-1/2	1-1/2"	Flanged	328.07
1050	488-1/2	2"	Flanged	388.81
1051	488-1/2	2-1/2"	Flanged	593.10
1052	488-1/2	3"	Flanged	642.33
38202	488-1/2	4"	Flanged	1327.46

#### 7-1/2E Iron Body Gate Valves - 250# - Outside Screw & Yoke - Rising Stem (Flanged)

- Bronze Trim
- Solid wedge disc
- Non-Asbestos packing and gaskets
- Bronze stem
- Renewable bronze seat rings
- ACME Double stem threads
- Working pressure non-shock:  
250 psi Steam, basic rating  
500 psi Cold working pressure

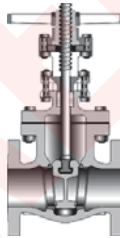

**CRANE**

Part #	Mfg #	Size	Type	Price
622	7-1/2E	2"	Flanged	723.32
633	7-1/2E	2-1/2"	Flanged	130.58
624	7-1/2E	3"	Flanged	940.95
625	7-1/2E	4"	Flanged	1331.60
626	7-1/2E	5"	Flanged	2473.16
627	7-1/2E	6"	Flanged	2320.86
628	7-1/2E	8"	Flanged	4108.43

### F-667-O 250# Iron OS&Y Gate Valves (Flange x Flange)

- Bolted bonnet
- Outside screw & yoke
- Solid wedge
- Bronze mounted
- 200 psi Non-shock cold working pressure

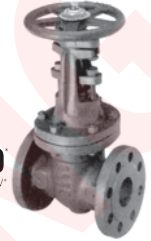

Part #	Mfg #	Size	Type	Price
164406	F-667-O	2"	Flanged	682.01
164407	F-667-O	2-1/2"	Flanged	830.64
164408	F-667-O	3"	Flanged	907.82
164409	F-667-O	4"	Flanged	1251.97
164411	F-667-O	6"	Flanged	2333.57
164412	F-667-O	8"	Flanged	3848.50
238922	F-667-O	10"	Flanged	Call
164414	F-667-O	12"	Flanged	Call

### Iron Globe Valves

#### 351 Iron Globe Valves - 125# - Outside Screw & Yoke - Rising Stem - (Flanged)

- Bronze trim
- Integral yoke bonnet with upper and lower bronze bushing provides for centering of internal parts
- Non galling 2-piece packing gland
- Provided with a back seat
- Renewable - regrind able screwed-in seat ring
- Bottom guided disc - Manganese bronze stem
- Non-asbestos packing and gaskets
- Solid bronze disc on 6" or smaller
- ANSI B16.10, ANSI B16.1
- MSS-SP-85 Type 1
- Working pressures non-shock:  
125 psi Steam, basic rating  
200 psi Cold working pressure

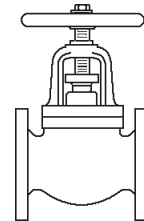

**CRANE**

Part #	Mfg #	Size	Type	Price
838	351	2"	Flanged	646.93
839	351	2-1/2"	Flanged	677.76
840	351	3"	Flanged	761.51
841	351	4"	Flanged	1080.37
842	351	5"	Flanged	2015.80
843	351	6"	Flanged	2015.80
844	351	8"	Flanged	3607.52



## Globe Valves - Iron

### 21E Iron Globe Valves - 250# - Outside Screw & Yoke - Rising Stem - (Flanged)

- Bronze trim
- Bronze seat ring, ASTM B61
- Disc stem ring
- Manganese bronze stem
- Provided with a back seat
- Bottom guided disc
- Renewable - regrind able screwed-in seat ring
- Non-asbestos packing and gaskets
- Solid bronze disc, ASTM B61 - 3" and smaller; cast iron with bronze facing - 4" and larger
- ANSI B16.10, ANSI B16.1
- MSS-SP-85 Type 1
- Working pressures non-shock:  
 250 psi Steam, basic rating  
 500 psi Cold working pressure

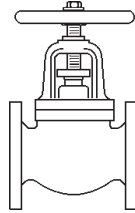

CRANE

Part #	Mfg #	Size	Type	Price
649	21E	2"	Flanged	1141.57
650	21E	2-1/2"	Flanged	1179.76
651	21E	3"	Flanged	1216.57
652	21E	4"	Flanged	1788.04
653	21E	6"	Flanged	3233.74

### Iron Body Check Valves

#### 373 Iron Swing Check Valves - 125# - Bolted Cap - (Flanged)

- Bronze trim
- Design prohibits galling or scoring of seating surfaces because the disc meets the flat seat squarely on closing with no rubbing action
- Replaceable bronze seat rings
- Bronze hinges in 6" and smaller; ductile iron in larger sizes
- Large bolted-on cover
- Solid bronze disc 6" and smaller; bronze faced cast iron on larger sizes
- Replaceable brass hinge pins
- ANSI B16.1, MSS-SP-71 Type 1
- ANSI B16.10 - 14" and smaller
- Working pressures non-shock:
  - 125 psi Steam, basic rating
  - 200 psi Cold working pressure

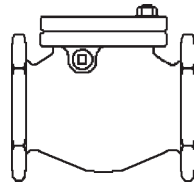

CRANE

Part #	Mfg #	Size	Type	Price
860	373	2"	Flanged	228.69
861	373	2-1/2"	Flanged	265.95
862	373	3"	Flanged	288.96

### Iron Body Check Valves (Continued)

#### 373 Iron Swing Check Valves - 125# - Bolted Cap - (Flanged)

Part #	Mfg #	Size	Type	Price
863	373	4"	Flanged	447.24
864	373	5"	Flanged	761.51
865	373	6"	Flanged	761.51
866	373	8"	Flanged	1520.71

#### F-918-B 125# Cast Iron Check Valves (Flange x Flange)

- Bolted bonnet
- Horizontal swing
- Renewable seat and disc

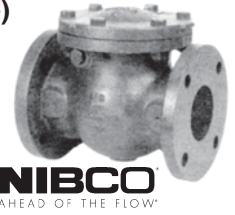

**NIBCO**  
 AHEAD OF THE FLOW™

Part #	Mfg #	Size	Type	Price
164424	F-918-B	2"	Flanged	266.40
164425	F-918-B	2-1/2"	Flanged	255.77
122695	F-918-B	3"	Flanged	272.12
164426	F-918-B	4"	Flanged	427.04
822123	F-918-B	5"	Flanged	603.85
163829	F-918-B	6"	Flanged	730.03

#### F-918-B 125# Cast Iron Check Valves (Flange x Flange) with Lever & Spring

Part #	Mfg #	Size	Type	Price
164432	F-918-B	3" w/L&S	Flanged	644.85
164431	F-918-B	4" w/L&S	Flanged	820.35
164434	F-918-B	6" w/L&S	Flanged	1275.98

Prices & specifications are subject to change.

Our faucet parts counter is one of the largest in the Boston area with thousands of parts in stock!



## Check Valves - Iron

### 383 Iron Body Swing Check Valve - 125# - Weight & Lever - (Flanged)

- Outside lever and weight with bronze trim
- Design prohibits galling or scoring of seating surfaces because the disc meets the flat seat squarely on closing with no rubbing action
- Large bolted on cover
- Recommended where quick action is necessary to avoid sudden reversal of flow
- Solid bronze disc in 6" or smaller; bronze faced in 8" or larger
- Replaceable brass/stainless steel hinge pins
- Solid bronze hinge pins in 6" or smaller; ductile iron for 8" and larger
- Working pressures non-shock:
  - 125 psi Steam, basic rating
  - 200 psi Cold working pressure



**CRANE**

Part #	Mfg #	Size	Type	Price
888	383	2-1/2"	Flanged	704.45
889	383	3"	Flanged	745.86
890	383	4"	Flanged	973.16
891	383	6"	Flanged	1445.71
892	383	8"	Flanged	2419.78

### 346-1/2 Malleable Iron Swing Check Valve - Y-Pattern - (FNPT)

- 700 SWP/1000 CWP
- Malleable iron body and cap
- Hinge pin 13% chromium stainless steel
- ANSI/ASME B1.20.1

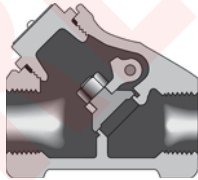

**CRANE**

Part #	Mfg #	Size	Type	Price
832	346-1/2	1/2"	IPS	269.64
833	346-1/2	3/4"	IPS	292.64
834	346-1/2	1"	IPS	343.26
835	346-1/2	1-1/4"	IPS	415.49
836	346-1/2	1-1/2"	IPS	452.31
837	346-1/2	2"	IPS	496.94

### W-910-B 125# Silent Check Valves (WF x WF)

- Wafer style
- Renewable seats and disc
- Spring actuated
- 200 psi Non-shock cold working pressure



Part #	Mfg #	Size	Type	Price
179277	W-910-B	2"	Wafer	182.37
203492	W-910-B	2-1/2"	Wafer	206.95
200409	W-910-B	3"	Wafer	229.24
198355	W-910-B	4"	Wafer	308.14
209268	W-910-B	5"	Wafer	433.90
198356	W-910-B	6"	Wafer	558.53
215520	W-910-B	8"	Wafer	1007.29

### Fig F-910-B 125# WOG CI Globe Style Silent Check Valves (Flange x Flange)

- Globe style
- Renewable seats and disc
- Spring actuated
- 200 psi Non-shock cold working pressure



Part #	Mfg #	Size	Type	Price
164622	F-910-B	4"	Flanged	588.83
194579	F-910-B	5"	Flanged	657.69
187954	F-910-B	6"	Flanged	974.71
187953	F-910-B	8"	Flanged	Call
198695	F-910-B	10"	Flanged	Call
906016	F-910-B	12"	Flanged	Call

### F-908-W 175# Cast Iron Check Valves (Flange x Flange)

- Fire protection valve
- UL/ULC Listed
- FMRC Approved
- Bolted bonnet
- Horizontal swing
- Renewable seat and disc



Part #	Mfg #	Size	Type	Price
164521	F-908-W	3"	Flanged	636.33
164522	F-908-W	4"	Flanged	661.40
164524	F-908-W	6"	Flanged	1055.44
164525	F-908-W	8"	Flanged	1790.85

Valves



## Check Valves - Iron

### Iron Stop Check Valves

#### Iron Body Stop Check Valves - 250# - Y-Pattern - Non-Return (Flanged)

- For installation between boilers supplying the same stream header and positioned with pressure under the disc
- Bolted bonnet
- Cylindrical shaped disc is the only pressure-actuated part
- Long throttling lip on disc
- Flat seats
- Removable cast iron liner
- Dashpot is self-contained in the liner
- ANSI B16.1
- Integral bosses for drain connections; bosses are tapped and plugged
- Working pressure non-shock:  
 250 psi Steam, basic rating  
 500 psi Cold working pressure



**CRANE**

#### 28E Series - Straightway

- For horizontal or vertical line with upward flow

Part #	Mfg #	Size	Type	Price
661	28E	2-1/2"	Flanged	3538.80
662	28E	3"	Flanged	3195.55
663	28E	4"	Flanged	3880.67
664	28E	5"	Flanged	8165.97
665	28E	6"	Flanged	6732.50
666	28E	8"	Flanged	11412.40

#### 30E Series - Angle

- For "horizontal-downward" or "upward-horizontal" flow



**CRANE**

Part #	Mfg #	Size	Type	Price
677	30E	2-1/2"	Flanged	1824.85
678	30E	3"	Flanged	1978.07
679	30E	4"	Flanged	2357.67
680	30E	5"	Flanged	6847.53
681	30E	6"	Flanged	4261.19
682	30E	8"	Flanged	7303.97

### F-869-B 250# Cast Iron Angle Valves (Flange x Flange)

- Automatic stop check
- Bolted bonnet
- Angle pattern
- Renewable seat and disc
- Bronze mounted
- 500 psi Non-shock cold working pressure

**NIBCO**  
 AHEAD OF THE FLOW™

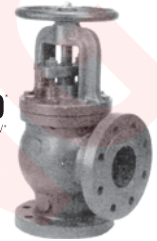

Part #	Mfg #	Size	Type	Price
199504	F-869-B	4"	Flanged	2531.37
199503	F-869-B	6"	Flanged	4488.20
215101	F-869-B	8"	Flanged	6230.77

**STORE HOURS**

**Monday - Friday  
 6AM - 4:30PM**

Valves



## Gate Valves - Cast Steel

### Cast Steel Gate Valves

#### Cast Steel Gate Valves - 150# - Outside Screw & Yoke - Flexible Wedge Disc

- Flexible wedge disc
- Carbon steel, ASTM A216 Grade WCB 285 psi @ -20°F to 100°F
- Seating surfaces - 13% chromium
- Excellent for steam, gas and general services to 1000°F; oil and oil vapor to 100°F; and all services for swing check valves to 100°F

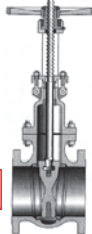

**CRANE**

#### 47XUF Series - (Flanged)

- Flexible disc
- 13% Chromium AISI Type 410 stainless steel trim
- Hard facing is weld deposited cobalt base alloy

Part #	Mfg #	Size	Type	Price
727	47XUF	2"	Flanged	327.63
728	47XUF	2-1/2"	Flanged	463.83
729	47XUF	3"	Flanged	463.83
730	47XUF	4"	Flanged	576.04
731	47XUF	5"	Flanged	854.34
732	47XUF	6"	Flanged	897.07
733	47XUF	8"	Flanged	1367.84
734	47XUF	10"	Flanged	2024.83
735	47XUF	12"	Flanged	2763.82

#### 47-1/2XUF Series - (Butt Weld)

- Flexible disc
- 13% Chromium AISI Type 410 stainless steel trim
- Hard facing is weld deposited cobalt base alloy

Part #	Mfg #	Size	Type	Price
736	47-1/2XUF	2"	Butt Weld	458.61
737	47-1/2XUF	2-1/2"	Butt Weld	563.54
738	47-1/2XUF	3"	Butt Weld	563.54
739	47-1/2XUF	4"	Butt Weld	709.11
740	47-1/2XUF	6"	Butt Weld	1073.57
741	47-1/2XUF	8"	Butt Weld	1558.58
742	47-1/2XUF	10"	Butt Weld	2178.74
743	47-1/2XUF	12"	Butt Weld	2973.67

### Powell 1503 Series OS&Y 150LB Gate Valves

- Outside Screw Rising Stem
- Bolted flange yoke-bonnet
- ASME B16.34

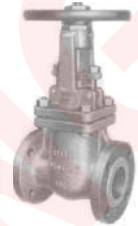

#### 150LB Flanged OS&Y Gate Valves

Part #	Mfg #	Size	Type	Price
2949	1503FE	2-1/2"	Flanged	1380.00
2948	1503FE	2"	Flanged	925.00
2950	1503FE	3"	Flanged	1469.00
2951	1503FE	4"	Flanged	2291.00
2952	1503FE	6"	Flanged	3386.00
2953	1503FE	8"	Flanged	5301.00
2954	1503FE	10"	Flanged	7280.00
2955	1503FE	12"	Flanged	10667.00

#### 150LB Weld OS&Y Gate Valves

Part #	Mfg #	Size	Type	Price
2956	1503WE	2"	Weld	1018.00
2958	1503WE	3"	Weld	1615.00
2959	1503WE	4"	Weld	2520.00
2960	1503WE	6"	Weld	3725.00
2961	1503WE	8"	Weld	5831.00
2962	1503WE	10"	Weld	8008.00
2963	1503WE	12"	Weld	11733.00

### Cast Steel Gate Valve - 300# - Outside Screw & Yoke - Flexible Wedge Disc

- Carbon steel, ASTM A216 Grade WCB 740 psi @ -20°F to 100°F
- Seating surfaces - 13% chromium
- Excellent for steam, gas and general services to 1000°F; oil and oil vapor to 100°F; and all services for swing check valves to 100°F

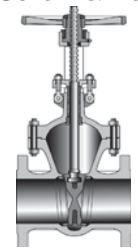

**CRANE**

#### 33XUF Series - (Flanged)

- Flexible disc
- 13% Chromium AISI Type 410 stainless steel trim
- Hard facing is weld deposited cobalt base alloy

Part #	Mfg #	Size	Type	Price
684	33XUF	2"	Flanged	447.49
685	33XUF	2-1/2"	Flanged	603.84
686	33XUF	3"	Flanged	603.84
687	33XUF	4"	Flanged	841.13





## Gate Valves - Cast Steel

### Cast Steel Gate Valves (Continued)

#### Cast Steel Gate Valve - 300# - Outside Screw & Yoke - Flexible Wedge Disc 33XUF Series - (Flanged)

Part #	Mfg #	Size	Type	Price
688	33XUF	5"	Flanged	1352.90
689	33XUF	6"	Flanged	1421.34
690	33XUF	8"	Flanged	2225.65
691	33XUF	10"	Flanged	2985.13
692	33XUF	12"	Flanged	4309.88

#### 33-1/2XUF Series - (Butt Weld)

- Flexible disc
- 13% Chromium AISI Type 410 stainless steel trim
- Hard facing is weld deposited cobalt base alloy

Part #	Mfg #	Size	Type	Price
693	33-1/2XUF	2"	Butt Weld	552.07
694	33-1/2XUF	2-1/2"	Butt Weld	709.11
695	33-1/2XUF	3"	Butt Weld	695.56
696	33-1/2XUF	4"	Butt Weld	882.13
697	33-1/2XUF	6"	Butt Weld	1492.22
698	33-1/2XUF	8"	Butt Weld	2336.13
699	33-1/2XUF	10"	Butt Weld	3134.87
700	33-1/2XUF	12"	Butt Weld	4426.62

#### Powell 3003 Series OS&Y 300LB Gate Valves

- Outside screw rising stem
- Bolted flange yoke-bonnet
- ASME B16.34



#### 300LB Flanged OS&Y Gate Valves

Part #	Mfg #	Size	Type	Price
2964	3003FE	2"	Flanged	1263.00
2965	3003FE	2-1/2"	Flanged	1762.00
2966	3003FE	3"	Flanged	2026.00
2967	3003FE	4"	Flanged	2658.00
2968	3003FE	6"	Flanged	5039.00
2969	3003FE	8"	Flanged	8112.00
2970	3003FE	10"	Flanged	11861.00

#### 300LB Weld OS&Y Gate Valves

Part #	Mfg #	Size	Type	Price
2972	3003WE	2"	Weld	1389.00
2973	3003WE	2-1/2"	Weld	1938.00

### Cast Steel Gate Valves (Continued)

#### Powell 3003 Series OS&Y 300LB Gate Valves 300LB Weld OS&Y Gate Valves

Part #	Mfg #	Size	Type	Price
2974	3003WE	3"	Weld	2229.00
2975	3003WE	4"	Weld	2924.00
2976	3003WE	6"	Weld	5543.00
2977	3003WE	8"	Weld	8923.00
2978	3003WE	10"	Weld	13047.00
2979	3003WE	12"	Weld	17926.00

#### Cast Steel Gate Valve - 600# - Outside Screw & Yoke - Flexible Wedge Disc

- Flexible wedge disc
- Carbon steel, ASTM A216 Grade WCB 1480 psi @ -20°F to 100°F
- Seating surfaces - 13% chromium
- Excellent for steam, gas and general services to 1000°F; oil and oil vapor to 100°F; and all services for swing check valves to 100°F

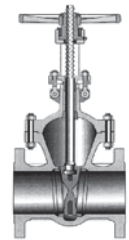

CRANE

#### 76XUF Series - (Flanged)

- Flexible disc
- 13% Chromium AISI Type 410 stainless steel trim
- Hard facing is weld deposited cobalt base alloy

Part #	Mfg #	Size	Type	Price
754	76XUF	2"	Flanged	677.15
755	76XUF	2-1/2"	Flanged	923.13
756	76XUF	3"	Flanged	923.13
757	76XUF	4"	Flanged	1488.40
759	76XUF	6"	Flanged	2813.85

#### 76-1/2XUF Series - (Butt Weld)

- Flexible disc
- 13% Chromium AISI Type 410 stainless steel trim
- Hard facing is weld deposited cobalt base alloy

Part #	Mfg #	Size	Type	Price
760	76-1/2XUF	2"	Butt Weld	713.28
761	76-1/2XUF	2-1/2"	Butt Weld	941.90
762	76-1/2XUF	3"	Butt Weld	971.42
763	76-1/2XUF	4"	Butt Weld	1567.27
764	76-1/2XUF	6"	Butt Weld	2961.50

Prices & specifications are subject to change.

You can check stock availability, pricing and place orders online at [www.MetPipe.com](http://www.MetPipe.com).



## Globe Valves - Cast Steel

### Cast Steel Globe Valves

#### Cast Steel Globe Valve - 150# - Outside Screw & Yoke - Bolted Bonnet

- Welded-in seat ring
- Fugitive emissions less than 100PPM with standard requirements
- Carbon steel, ASTM A216 Grade WCB 285 psi @ -20°F to 100°F
- Seating surfaces - 13% chromium
- Excellent for steam, gas and general services to 1000°F; oil and oil vapor to 100°F; and all services for swing check valves to 100°F

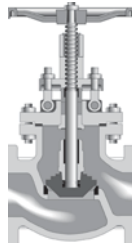

**CRANE**

#### 143XU Series - (Flanged)

- 13% Chromium AISI Type 410 stainless steel trim
- Hard facing is weld deposited cobalt base alloy

Part #	Mfg #	Size	Type	Price
785	143XU	2"	Flanged	412.06
786	143XU	2-1/2"	Flanged	521.85
787	143XU	3"	Flanged	521.85
788	143XU	4"	Flanged	763.31
789	143XU	6"	Flanged	1200.38
45655	143XU	8"	Flanged	6350.00
239108	143XU	10"	Flanged	11247.00
138763	143XU	12"	Flanged	Call

#### 143-1/2XU Series - (Butt Weld)

- 13% Chromium AISI Type 410 stainless steel trim
- Hard facing is weld deposited cobalt base alloy

Part #	Mfg #	Size	Type	Price
790	143-1/2XU	2"	Butt Weld	468.34
791	143-1/2XU	2-1/2"	Butt Weld	597.24
792	143-1/2XU	3"	Butt Weld	597.24
793	143-1/2XU	4"	Butt Weld	801.87
33470	143-1/2XU	6"	Butt Weld	1260.48
46286	143-1/2XU	8"	Butt Weld	Call
924607	143-1/2XU	10"	Butt Weld	Call
240495	143-1/2XU	12"	Butt Weld	Call

### Powell 1531 Series Globe Valves

- Bolted Flanged Bonnet
- Flanged & Weld ends
- ASME B16.34



#### 150LB Globe Valves

Part #	Mfg #	Size	Type	Price
2980	1531FE	2"	Flanged	1160.00
2981	1531FE	2-1/2"	Flanged	1561.00
2982	1531FE	3"	Flanged	1962.00
2983	1531FE	4"	Flanged	2600.00
2984	1531FE	6"	Flanged	4369.00
2986	1531WE	2"	Weld	1276.00
2987	1531WE	2-1/2"	Weld	1717.00
2988	1531WE	3"	Weld	2159.00
2989	1531WE	4"	Weld	2860.00
2990	1531WE	6"	Weld	4806.00

#### Cast Steel Globe Valve - 300# - Outside Screw & Yoke - Bolted Bonnet

- Welded-in seat ring
- Fugitive emissions less than 100PPM with standard requirements
- Carbon steel, ASTM A216 Grade WCB 740 psi @ -20°F to 100°F
- Seating surfaces - 13% chromium
- Excellent for steam, gas and general services to 1000°F; oil and oil vapor to 100°F; and all services for swing check valves to 100°F



**CRANE**

#### 151XU Series - (Flanged)

- 13% Chromium AISI Type 410 stainless steel trim
- Hard facing is weld deposited cobalt base alloy

Part #	Mfg #	Size	Type	Price
800	151XU	2"	Flanged	551.72
801	151XU	2-1/2"	Flanged	750.11
802	151XU	3"	Flanged	750.11
803	151XU	4"	Flanged	1037.09
805	151XU	6"	Flanged	1874.05
806	151XU	8"	Flanged	3068.51



## Globe Valves - Cast Steel

### 151-1/2XU Series - (Butt Weld)

- 13% Chromium AISI Type 410 stainless steel trim
- Hard facing is weld deposited cobalt base alloy

Part #	Mfg #	Size	Type	Price
807	151-1/2XU	2-1/2"	Butt Weld	789.37
808	151-1/2XU	3"	Butt Weld	789.37
809	151-1/2XU	4"	Butt Weld	1091.98
33476	151-1/2XU	6"	Butt Weld	1972.37

### Powell 3031, 6031 Series Globe Valves

- Bolted Flanged Bonnet
- Flanged & Weld ends
- ASME B16.34



### 300LB Globe Valves

Part #	Mfg #	Size	Type	Price
2991	3031FE	2"	Flanged	1487.00
2992	3031FE	2-1/2"	Flanged	2081.00
2993	3031FE	3"	Flanged	2445.00
2994	3031FE	4"	Flanged	3505.00
2995	3031FE	6"	Flanged	6595.00
238628	3031WE	2"	Weld	Call
2998	3031WE	2-1/2"	Weld	2290.00
2999	3031WE	3"	Weld	2689.00
3000	3031WE	4"	Weld	3855.00
3001	3031WE	6"	Weld	7254.00

### 600LB Globe Valves

Part #	Mfg #	Size	Type	Price
53313	6031FE	3"	Flanged	3171.00
119509	6031FE	4"	Flanged	1232.69

## Cast Steel Swing Check Valves

### Cast Steel Swing Check Valve - 150# - Bolted Cap

- Internally mounted hinge pin which eliminates a leak path
- Welded-in seat ring
- Carbon steel, ASTM A216 Grade WCB 285 psi @ -20°F to 100°F
- Seating surfaces - 13% chromium
- Excellent for steam, gas and general services to 1000°F; oil and oil vapor to 100°F; and all services for swing check valves to 100°F

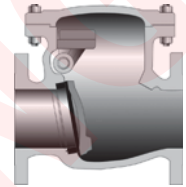

CRANE

### 147XU Series - (Flanged)

- 13% Chromium AISI Type 410 stainless steel trim
- Hard facing is weld deposited cobalt base alloy

Part #	Mfg #	Size	Type	Price
794	147XU	2"	Flanged	305.40
795	147XU	2-1/2"	Flanged	353.69
796	147XU	3"	Flanged	360.64
797	147XU	4"	Flanged	518.02
798	147XU	6"	Flanged	809.52
799	147XU	8"	Flanged	1324.06
44168	147XU	10"	Flanged	1957.43
115346	147XU	12"	Flanged	8047.00

### 147-1/2XU Series - (Butt Weld)

- 13% Chromium AISI Type 410 stainless steel trim
- Hard facing is weld deposited cobalt base alloy

Part #	Mfg #	Size	Type	Price
33471	147-1/2XU	2"	Butt Weld	380.79
33472	147-1/2XU	2-1/2"	Butt Weld	455.49
33473	147-1/2XU	3"	Butt Weld	455.49
33474	147-1/2XU	4"	Butt Weld	644.49
33475	147-1/2XU	6"	Butt Weld	979.06
107945	147-1/2XU	8"	Butt Weld	1558.58

### Powell 1561 Series Swing Check Valves

- Bolted flanged cap
- ASME B16.34
- Flanged & weld ends



### 150LB Swing Check Valves

Part #	Mfg #	Size	Type	Price
3003	1561FE	2"	Flanged	793.00
3004	1561FE	2-1/2"	Flanged	960.00
3005	1561FE	3"	Flanged	115.00
3006	1561FE	4"	Flanged	1809.00



## Check Valves - Cast Steel

### Cast Steel Swing Check Valves (Continued)

#### Powell 1561 Series Swing Check Valves

##### 150LB Swing Check Valves

Part #	Mfg #	Size	Type	Price
3007	1561FE	6"	Flanged	2671.00
3008	1561FE	8"	Flanged	4542.00
3009	1561WE	2"	Weld	872.00
3011	1561WE	3"	Weld	1270.00
3012	1561WE	4"	Weld	1989.00
3013	1561WE	6"	Weld	2938.00
3014	1561WE	8"	Weld	4997.00

#### Cast Steel Swing Check Valve - 300# - Bolted Cap

- Internally mounted hinge pin which eliminates a leak path
- Welded-in seat ring
- Carbon steel, ASTM A216 Grade WCB 740 psi @ -20°F to 100°F
- Seating surfaces - 13% chromium
- Excellent for steam, gas and general services to 1000°F; oil and oil vapor to 100°F; and all services for swing check valves to 100°F

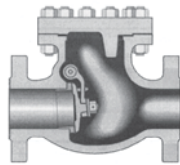

**CRANE**

#### 159XU Series - (Flanged)

- 13% Chromium AISI Type 410 stainless steel trim
- Hard facing is weld deposited cobalt base alloy

Part #	Mfg #	Size	Type	Price
810	159XU	2"	Flanged	324.85
811	159XU	2-1/2"	Flanged	488.15
812	159XU	3"	Flanged	488.15
813	159XU	4"	Flanged	635.46
814	159XU	6"	Flanged	1230.95
815	159XU	8"	Flanged	1776.77
46399	159XU	10"	Flanged	Call
862491	159XU	12"	Flanged	Call

#### 159-1/2XU Series - (Butt Weld)

- 13% Chromium AISI Type 410 stainless steel trim
- Hard facing is weld deposited cobalt base alloy

Part #	Mfg #	Size	Type	Price
46059	159-1/2XU	2"	Butt Weld	Call
48502	159-1/2XU	2-1/2"	Butt Weld	560.06
48503	159-1/2XU	3"	Butt Weld	560.06
46024	159-1/2XU	4"	Butt Weld	741.77
48094	159-1/2XU	6"	Butt Weld	1379.30
48506	159-1/2XU	8"	Butt Weld	5788.00
222191	159-1/2XU	10"	Butt Weld	Call
924608	159-1/2XU	12"	Butt Weld	Call

### Powell 3061 Series Swing Check Valves

- Bolted flanged cap
- ASME B16.34
- Flanged & weld ends



#### 300LB Swing Check Valves

Part #	Mfg #	Size	Type	Price
3015	3061FE	2"	Flanged	960.00
3016	3061FE	2-1/2"	Flanged	1405.00
3017	3061FE	3"	Flanged	1614.00
3018	3061FE	4"	Flanged	2309.00
3019	3061FE	6"	Flanged	4118.00
3020	3061FE	8"	Flanged	6159.00
3021	3061WE	2"	Weld	1056.00
3022	3061WE	2-1/2"	Weld	1546.00
3023	3061WE	3"	Weld	1775.00
3024	3061WE	4"	Weld	2540.00
3025	3061WE	6"	Weld	4530.00

#### 600LB Swing Check Valves

Part #	Mfg #	Size	Type	Price
914922	6061FE	2"	Flanged	Call
877303	6061FE	2-1/2"	Flanged	Call
157733	6061FE	3"	Flanged	Call
12466	6061FE	4"	Flanged	107.26
896668	6061FE	6"	Flanged	Call
855649	6061FE	8"	Flanged	Call
888866	6061WE	2-1/2"	Weld	Call
900386	6061WE	3"	Weld	Call
188509	6061WE	4"	Weld	Call

### Cast Steel Check Valves

#### Powell 3084 & 6084 Series Non-Return Stop Check Valves

- Bolted Flanged Bonnet
- Pressure/Temperature rating in accordance with ASME B16.34
- Flanged & Weld connections
- Straight & Angle types

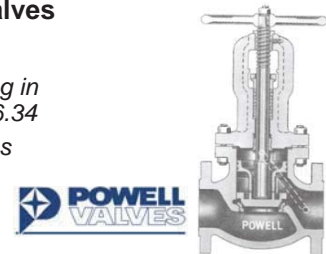

#### 300LB Non-Return Stop Check Valves

Part #	Mfg #	Size	Type	Pattern	Price
3092	3084FE	4"	Flanged	Straight	4682.00
3093	3084FE	6"	Flanged	Straight	6982.00
3094	3084FE	8"	Flanged	Straight	9600.00

Prices & specifications are subject to change.



## Check Valves - Cast Steel

### Cast Steel Check Valves (Continued)

#### Powell 3084 & 6084 Series Non-Return Stop Check Valves

##### 300LB Non-Return Stop Check Valves

Part #	Mfg #	Size	Type	Pattern	Price
3095	3084FE	10"	Flanged	Straight	16455.00
3096	3086FE	4"	Flanged	Angle	4582.00
3098	3086FE	6"	Flanged	Angle	6973.00
3099	3086FE	8"	Flanged	Angle	9600.00
3100	3086FE	10"	Flanged	Angle	16455.00

##### 600LB Non-Return Stop Check Valves

Part #	Mfg #	Size	Type	Pattern	Price
3101	6084FE	4"	Flanged	Straight	6055.00
3102	6084FE	6"	Flanged	Straight	9891.00
3103	6084FE	8"	Flanged	Straight	17073.00
3105	6086FE	4"	Flanged	Angle	6055.00
3106	6086FE	6"	Flanged	Angle	9582.00
3107	6086FE	8"	Flanged	Angle	17073.00



**FREE Local Delivery**



## Gate Valves - Forged Steel

### Vogt Gate Valves

#### 12111 - 800# A105 Forged Gate Valves

- Conventional port
- 1975 psi @ 100°F
- Round bolted bonnet
- Spiral wound gasket
- Outside screw & yoke
- Bolted gland
- Solid wedge
- Hard faced seats
- ASME B16.34



Vogt Valves

#### IPS

Part #	Mfg #	Size	Type	Price
2796	12111	1/4"	IPS	54.70
2797	12111	3/8"	IPS	54.70
2798	12111	1/2"	IPS	52.18
2799	12111	3/4"	IPS	58.91
2800	12111	1"	IPS	71.53
2801	12111	1-1/4"	IPS	360.17
2802	12111	1-1/2"	IPS	148.95
2803	12111	2"	IPS	191.03
2804	12111	2-1/2"	IPS	873.48
118196	12111	3"	IPS	1723.40

#### Socket Weld

Part #	Mfg #	Size	Type	Price
2805	SW12111	1/4"	Socket Weld	54.70
2806	SW12111	3/8"	Socket Weld	54.70
2807	SW12111	1/2"	Socket Weld	52.18
2808	SW12111	3/4"	Socket Weld	58.91
2809	SW12111	1"	Socket Weld	71.53
2810	SW12111	1-1/4"	Socket Weld	360.17
2811	SW12111	1-1/2"	Socket Weld	148.95
2812	SW12111	2"	Socket Weld	191.03
2813	SW12111	2-1/2"	Socket Weld	873.48
111156	SW12111	3"	Socket Weld	1843.73

#### IPS x Socket Weld

Part #	Mfg #	Size	Type	Price
2814	TSW12111	1/2"IPS x Socket Weld		52.18
2815	TSW12111	3/4"IPS x Socket Weld		58.91
33587	TSW12111	1"IPS x Socket Weld		71.53
40080	TSW12111	1-1/2"IPS x Socket Weld		145.20
40617	TSW12111	2"IPS x Socket Weld		186.56

### 2801 - 800# A105 Forged Gate Valves Welded Bonnet

- Conventional port
- 1975 psi @ 100°F
- Welded bonnet
- Outside screw & yoke
- Bolted gland
- Solid wedge
- Hard faced seats
- ASME B16.34



Vogt Valves

#### IPS

Part #	Mfg #	Size	Type	Price
2756	2801	1/2"	IPS	61.43
2757	2801	3/4"	IPS	69.01
2758	2801	1"	IPS	82.47
2759	2801	1-1/4"	IPS	360.17
2760	2801	1-1/2"	IPS	157.37
2761	2801	2"	IPS	201.96

#### Socket Weld

Part #	Mfg #	Size	Type	Price
2764	SW2801	1/2"	Socket Weld	61.43
2765	SW2801	3/4"	Socket Weld	69.01
2766	SW2801	1"	Socket Weld	82.47
2768	SW2801	1-1/2"	Socket Weld	157.37
2769	SW2801	2"	Socket Weld	201.96

#### IPS x Socket Weld

Part #	Mfg #	Size	Type	Price
2720	TSW2801	1/2"IPS / Socket Weld		351.12
2771	TSW2801	3/4"IPS / Socket Weld		69.01
49430	TSW2801	1"IPS / Socket Weld		44.60
878767	TSW2801	1-1/2"IPS / Socket Weld		157.37



## Gate Valves - Forged Steel

### 13111 - 800# A105 Forged Full Port Gate Valves

- Full port
- 1975 psi @ 100°F
- Round bolted bonnet
- Spiral wound gasket
- Outside screw & yoke
- Bolted gland
- Solid wedge
- Hard faced seats
- ASME B16.34



Vogt Valves

#### IPS

Part #	Mfg #	Size	Type	Price
2859	13111	1/2"	IPS	110.24
2860	13111	3/4"	IPS	159.05
2861	13111	1"	IPS	281.91
2862	13111	1-1/2"	IPS	334.92
2863	13111	2"	IPS	517.53

#### Socket Weld

Part #	Mfg #	Size	Type	Price
2864	SW13111	1/2"	Socket Weld	110.24
2865	SW13111	3/4"	Socket Weld	159.05
2866	SW13111	1"	Socket Weld	281.91
2867	SW13111	1-1/2"	Socket Weld	334.92
2868	SW13111	2"	Socket Weld	517.53

### 15111 - 1500# A105 Forged Gate Valves

- Conventional port
- 3705 psi @ 100°F
- Round bolted bonnet
- Spiral wound gasket
- Outside screw & yoke
- Bolted gland
- Solid wedge
- Hard faced seats
- ASME B16.34



Vogt Valves

#### IPS

Part #	Mfg #	Size	Type	Price
2869	15111	1/2"	IPS	329.03
2870	15111	3/4"	IPS	361.85
2871	15111	1"	IPS	426.65
2873	15111	1-1/2"	IPS	690.88
2874	15111	2"	IPS	945.85

#### Socket Weld

Part #	Mfg #	Size	Type	Price
2875	SW15111	1/2"	Socket Weld	329.03
2876	SW15111	3/4"	Socket Weld	361.85
2877	SW15111	1"	Socket Weld	426.65
2879	SW15111	1-1/2"	Socket Weld	690.88
2880	SW15111	2"	Socket Weld	945.85

#### IPS x Couplet with Extension

Part #	Mfg #	Size	Type	Price
35662	CT2801	1/2"	IPS / Couplet	141.38
35663	CT2801	3/4"	IPS / Couplet	151.47
35664	CT2801	1"	IPS / Couplet	193.55
35665	CT2801	1-1/2"	IPS / Couplet	414.48

#### IPS x Socket Weld with Extension

Part #	Mfg #	Size	Type	Price
43957	ST2801	1/2"	IPS / Socket Weld	98.46
37285	ST2801	3/4"	IPS / Socket Weld	101.83
136484	ST2801	1"	IPS / Socket Weld	119.68
226724	ST2801	1-1/2"	IPS / Socket Weld	232.32

#### IPS (Male x Female) with Extension

Part #	Mfg #	Size	Type	Price
41464	TT2801	1/2"	IPS	98.46
43967	TT2801	3/4"	IPS	101.83
43965	TT2801	1"	IPS	Call

### SW15801 - 1500# A105 Forged Gate Valves Welded Bonnet

- Conventional port
- 3705 psi @ 100°F
- Welded bonnet
- Outside screw & yoke
- Bolted gland
- Solid wedge
- Hard faced seats
- ASME B16.34



Vogt Valves

Part #	Mfg #	Size	Type	Price
51328	SW15801	1/2"	Socket Weld	307.99
51329	SW15801	3/4"	Socket Weld	337.45
48226	SW15801	1"	Socket Weld	398.88
51331	SW15801	1-1/2"	Socket Weld	645.44
51332	SW15801	2"	Socket Weld	884.42

Prices & specifications are subject to change.

Metropolitan Pipe offers FREE DELIVERY in the Greater Boston area.



## Gate Valves - Forged Steel

### 353 - 150# A105 Forged Gate Valves - Flanged

- Conventional port
- 285 psi @ 100°F
- Round bolted bonnet
- Spiral wound gasket
- Outside screw & yoke
- Bolted gland
- Solid wedge
- Hard faced seats
- ASME B16.34

Vogt Valves



Part #	Mfg #	Size	Type	Price
2665	353	3/4"	Flanged	148.95
2666	353	1"	Flanged	180.09
2667	353	1-1/2"	Flanged	262.55
2668	353	2"	Flanged	371.11
2669	353	3"	Flanged	849.08
2670	353	4"	Flanged	1549.21

### 363 - 300# A105 Forged Gate Valves

- 740 psi @ 100°F

Part #	Mfg #	Size	Type	Price
2671	363	1/2"	Flanged	154.00
2672	363	3/4"	Flanged	169.15
2673	363	1"	Flanged	212.90
2674	363	1-1/2"	Flanged	333.24
2675	363	2"	Flanged	451.05
2676	363	3"	Flanged	997.18

### 373 - 600# A105 Forged Gate Valves

- 1480 psi @ 100°F

Part #	Mfg #	Size	Type	Price
2677	373	1/2"	Flanged	226.37
2678	373	3/4"	Flanged	244.88
2679	373	1"	Flanged	297.90
2680	373	1-1/2"	Flanged	467.88
2681	373	2"	Flanged	647.12
2682	373	3"	Flanged	2436.99

### Vogt Globe Valves

#### 12141 - 800# A105 Forged Globe Valves

- Conventional port
- 1975 psi @ 100°F
- Round bolted bonnet
- Spiral wound gasket
- Outside screw & yoke
- Bolted gland
- Loose disc
- Integral hard faced seat
- ASME B16.34

Vogt Valves



IPS

Part #	Mfg #	Size	Type	Price
2816	12141	1/4"	IPS	95.09
2817	12141	3/8"	IPS	95.09
2818	12141	1/2"	IPS	90.05
2819	12141	3/4"	IPS	101.83
2820	12141	1"	IPS	126.23
2821	12141	1-1/4"	IPS	389.62
2822	12141	1-1/2"	IPS	263.39
2823	12141	2"	IPS	339.97

### Socket Weld

Part #	Mfg #	Size	Type	Price
2824	SW12141	1/4"	Socket Weld	95.09
2825	SW12141	3/8"	Socket Weld	95.09
2826	SW12141	1/2"	Socket Weld	90.05
2827	SW12141	3/4"	Socket Weld	101.83
2828	SW12141	1"	Socket Weld	126.23
2829	SW12141	1-1/4"	Socket Weld	389.62
2830	SW12141	1-1/2"	Socket Weld	263.39
2831	SW12141	2"	Socket Weld	339.97

#### 13141 - 800# A105 Forged Globe Valves

- Full port
- 1975 psi @ 100°F
- Round bolted bonnet
- Spiral wound gasket
- Outside screw & yoke
- Bolted gland
- Loose disc
- Integral hard faced seat
- ASME B16.34

Vogt Valves



IPS

Part #	Mfg #	Size	Type	Price
39505	13141	1/2"	IPS	267.60

Valves





## Globe Valves - Forged Steel

### Vogt Globe Valves (Continued)

#### 13141 - 800# A105 Forged Globe Valves

IPS

Part #	Mfg #	Size	Type	Price
39506	13141	3/4"	IPS	313.88
39507	13141	1"	IPS	414.86
39187	13141	1-1/4"	IPS	777.92
39511	13141	1-1/2"	IPS	796.06
39513	13141	2"	IPS	1158.75

Socket Weld

Part #	Mfg #	Size	Type	Price
51286	SW13141	1/2"	Socket Weld	267.60
51288	SW13141	3/4"	Socket Weld	313.88
42656	SW13141	1"	Socket Weld	414.86
876659	SW13141	1-1/4"	Socket Weld	796.06
51292	SW13141	1-1/2"	Socket Weld	796.06
51293	SW13141	2"	Socket Weld	1158.75

#### 15141 - 1500# A105 Forged Globe Valves

- Conventional port
- 3705 psi @ 100°F
- Round bolted bonnet
- Spiral wound gasket
- Outside screw & yoke
- Bolted gland
- Loose disc
- Integral hard faced seat
- ASME B16.34

Vogt Valves

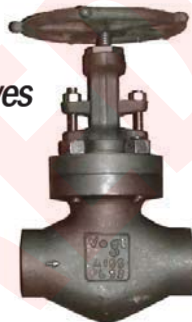

IPS

Part #	Mfg #	Size	Type	Price
2881	15141	1/2"	IPS	363.53
2882	15141	3/4"	IPS	398.88
2883	15141	1"	IPS	467.04
2884	15141	1-1/4"	IPS	694.24
2885	15141	1-1/2"	IPS	694.24
2886	15141	2"	IPS	990.45

Socket Weld

Part #	Mfg #	Size	Type	Price
2887	SW15141	1/2"	Socket Weld	363.53
2888	SW15141	3/4"	Socket Weld	398.88
2889	SW15141	1"	Socket Weld	467.04
860776	SW15141	1-1/4"	Socket Weld	Call
2891	SW15141	1-1/2"	Socket Weld	694.24
2892	SW15141	2"	Socket Weld	990.45

#### SW810 - 800# A105 Forged Y-Pattern Globe Valves (Socket Weld)

- Full port
- 2000 psi @ 100°F
- Seal welded bonnet
- Outside screw & yoke
- Bolted gland
- Removable yoke/operating mechanism
- Gate valve operating mechanism
- Repack able with endless pacing rings
- Loose hard faced disc
- Integral hard faced seat
- ASME B16.34 LTD Pressure class



Vogt Valves

Part #	Mfg #	Size	Type	Price
2724	SW810	1/2"	Socket Weld	304.63
2725	SW810	3/4"	Socket Weld	359.33
2726	SW810	1"	Socket Weld	427.49
2727	SW810	1-1/2"	Socket Weld	910.51
2728	SW810	2"	Socket Weld	1138.55

#### A105 Forged Y-Pattern Globe Valves (Socket Weld)

- Conventional port
- Welded bonnet
- Outside screw & yoke
- Bolted gland
- Loose solid Stellite disc
- Integral hard faced seat
- ASME B16.34 LTD Pressure class

Vogt Valves



#### SW1510 - 2500# A105 Forged Y-Pattern Globe Valves (Socket Weld)

- 4225 psi @ 100°F

Part #	Mfg #	Size	Type	Price
2734	SW1510	1/2"	Socket Weld	602.52
2735	SW1510	3/4"	Socket Weld	602.52
2736	SW1510	1"	Socket Weld	676.57
2737	SW1510	1-1/2"	Socket Weld	1519.75
2738	SW1510	2"	Socket Weld	1610.64

#### SW2510 - 2500# A105 Forged Y-Pattern Globe Valves (Socket Weld)

- 6700 psi @ 100°F

Part #	Mfg #	Size	Type	Price
2744	SW2510	1/2"	Socket Weld	767.45
2745	SW2510	3/4"	Socket Weld	1047.67
2746	SW2510	1"	Socket Weld	1047.67
2747	SW2510	1-1/2"	Socket Weld	2112.17

Prices & specifications are subject to change.

Metropolitan Pipe offers Vendor Managed Inventory - never run out of that part again!



## Globe Valves - Forged Steel

### Vogt Globe Valves (Continued)

#### A105 Forged Y-Pattern Globe Valves (Socket Weld)

##### SW2510 - 2500# A105 Forged Y-Pattern Globe Valves (Socket Weld)

Part #	Mfg #	Size	Type	Price
2748	SW2510	2"	Socket Weld	2464.76

#### A105 Forged Globe Valves (Flanged)

- Conventional port
- Round bolted bonnet
- Spiral wound gasket
- Outside screw & yoke
- Bolted gland
- Loose disk
- Integral hard faced seat
- ASME B16.34

Vogt Valves



#### 473 - 150# A105 Forged Globe Valves

- 285 psi @ 100° F

Part #	Mfg #	Size	Type	Price
2683	473	1/2"	Flanged	292.85
2684	473	3/4"	Flanged	323.98
2685	473	1"	Flanged	338.29
2686	473	1-1/2"	Flanged	547.82
2687	473	2"	Flanged	779.23

#### 483 - 300# A105 Forged Globe Valves

- 740 psi @ 100° F

Part #	Mfg #	Size	Type	Price
45901	483	1/2"	Flanged	318.09
45903	483	3/4"	Flanged	355.96
48315	483	1"	Flanged	369.42
48363	483	1-1/2"	Flanged	604.20
45904	483	2"	Flanged	854.97

#### 493 - 600# A105 Forged Globe Valves

- 1480 psi @ 100° F

Part #	Mfg #	Size	Type	Price
51297	493	1/2"	Flanged	350.91
51298	493	3/4"	Flanged	387.09
40706	493	1"	Flanged	410.66
51299	493	1-1/2"	Flanged	658.90
51300	493	2"	Flanged	923.97

### 12443 - 800# A105 Forged Globe Valves (FNPT)

- Conventional port
- 1975 psi @ 100°F
- For flow control service
- Round bolted bonnet
- Spiral wound gasket
- Outside screw & yoke
- Bolted gland
- Loose v-port disc
- Integral hard faced seat
- Dial & indicator
- ASME B16.34

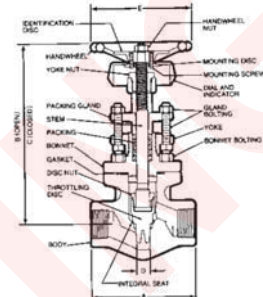

Vogt Valves

Part #	Mfg #	Size	Type	Price
2848	12443	1/2"	IPS	350.91
2849	12443	3/4"	IPS	422.44
2850	12443	1"	IPS	488.07

### Edwards Globe Valves

#### 800# Forged Steel Stop Valves

- 2000 psi @ 100°F
- Bodies & bonnets are of forged steel
- Bolted bonnet
- Body-guided hardened stainless steel seat
- Integral Stellite seat
- Integral backseat
- 13% Chromium stainless steel stem
- Asbestos-free spiral wound bonnet gasket
- Knobbed hand wheel

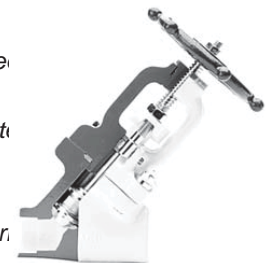

Edward Valve

#### 848 Series - Y-Pattern

Part #	Mfg #	Size	Type	Price
138572	848	1/2"	IPS	393.00
138573	848	3/4"	IPS	456.00
138134	848	1"	IPS	553.00
134159	848	1-1/4"	IPS	1174.00
138574	848	1-1/2"	IPS	1174.00
138575	848	2"	IPS	1562.00

#### 848Y Series - Y-Pattern

Part #	Mfg #	Size	Type	Price
138579	848Y	1/2"	Socket Weld	393.00
138580	848Y	3/4"	Socket Weld	456.00
138559	848Y	1"	Socket Weld	553.00
138581	848Y	1-1/4"	Socket Weld	1174.00
138582	848Y	1-1/2"	Socket Weld	1174.00
138583	848Y	2"	Socket Weld	1562.00

Prices & specifications are subject to change.



## Globe Valves - Forged Steel

### 849 Series - Angle

Part #	Mfg #	Size	Type	Price
859192	849	1/2"	IPS	430.00
138921	849	3/4"	IPS	519.00
151856	849	1"	IPS	600.00
145440	849	1-1/4"	IPS	1291.00
161786	849	1-1/2"	IPS	1291.00
147151	849	2"	IPS	1715.00

### 849Y Series - Angle

Part #	Mfg #	Size	Type	Price
151879	849Y	3/4"	Socket Weld	519.00
151862	849Y	1"	Socket Weld	600.00
151860	849Y	1-1/4"	Socket Weld	1291.00
142735	849Y	1-1/2"	Socket Weld	1291.00
151861	849Y	2"	Socket Weld	1715.00

### 1500# Stop Valves - (Socket Weld)

- 3600 psi @ 100°F
- Bodies & bonnets are of forged steel
- Bolted bonnet
- Body-guided hardened stainless steel disk
- Integral Stellite seat
- Integral backseat
- 13% Chromium stainless steel stem
- Asbestos-free graphitic packing
- Asbestos-free spiral wound bonnet gasket
- Knobbed hand wheel



Edward Valve

### 1048 Series A106 Forged Steel - Y-Pattern

Part #	Mfg #	Size	Type	Price
151897	1048Y	1/2"	Socket Weld	801.00
218905	1048Y	3/4"	Socket Weld	853.00
151899	1048Y	1"	Socket Weld	1038.00
146541	1048Y	1-1/2"	Socket Weld	1562.00
151901	1048Y	2"	Socket Weld	2151.00

### 1048Y Series F11 Forged Steel - Y-Pattern

Part #	Mfg #	Size	Type	Price
808423	1048Y	1/4"	Socket Weld	763.00
241129	1048Y	1/2"	Socket Weld	763.00
151898	1048Y	3/4"	Socket Weld	896.00
151893	1048Y	1"	Socket Weld	1248.00
808422	1048Y	1-1/4"	Socket Weld	1489.00
146542	1048Y	1-1/2"	Socket Weld	1871.00

## Edwards Globe Valves (Continued)

### 1500# Stop Valves - (Socket Weld)

### 1048Y Series F11 Forged Steel - Y-Pattern

Part #	Mfg #	Size	Type	Price
151894	1048Y	2"	Socket Weld	2573.00

### Class 2680 Blow-Off Valves

- Body Material is A105 carbon steel.
- OS & Y.
- Y-Pattern.
- Body-guided investment cast Stellite disk.
- Integral Stellite seat.
- Asbestos free graphitic packing.
- Impactor Handle/Impactor Hand wheel.
- Pressure Class 2500



Edward Valve

### A106 2680 Class Blow-Off Valves

Part #	Mfg #	Size	Type	Price
151969	66124	3/4"	Socket Weld	1303.00
151970	66124	1"	Socket Weld	1342.00

## Vogt Check Valves

### S74 - 800# A105 Forged Swing Check Valves (FNPT)

- Conventional port
- 1975 psi @ 100°F
- Horizontal or vertical upward flow
- Swing type check
- Welded seat insert with integral stainless steel seat deposit
- ASME B16.34

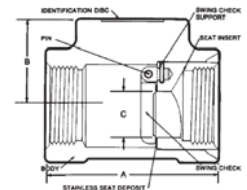

Vogt Valves

### IPS

Part #	Mfg #	Size	Type	Price
2654	S74	1/2"	IPS	166.62
2655	S74	3/4"	IPS	201.12
2656	S74	1"	IPS	311.36
2657	S74	1-1/2"	IPS	494.81
2658	S74	2"	IPS	584.85

### Socket Weld

Part #	Mfg #	Size	Type	Price
2659	SWS74	1/2"	Socket Weld	166.62
2660	SWS74	3/4"	Socket Weld	201.12
2661	SWS74	1"	Socket Weld	311.36

Prices & specifications are subject to change.

Our faucet parts counter is one of the largest in the Boston area with thousands of parts in stock!



## Check Valves - Forged Steel

### Vogt Check Valves (Continued)

#### S74 - 800# A105 Forged Swing Check Valves (FNPT)

Socket Weld

Part #	Mfg #	Size	Type	Price
2662	SWS74	1-1/2"	Socket Weld	494.81
2663	SWS74	2"	Socket Weld	584.85

#### 701 - 800# A105 Forged Piston Check Valves (FNPT)

- Conventional port
- 1975 psi @ 100°F
- Round bolted bonnet
- Spiral wound gasket
- Horizontal type
- Piston check
- Integral hard faced seats
- ASME B16.34



Vogt Valves

IPS

Part #	Mfg #	Size	Type	Price
2693	701	1/4"	IPS	85.00
2694	701	3/8"	IPS	85.00
2695	701	1/2"	IPS	84.15
2696	701	3/4"	IPS	93.41
2697	701	1"	IPS	117.81
2698	701	1-1/4"	IPS	330.71
2699	701	1-1/2"	IPS	270.97
2700	701	2"	IPS	295.37

Socket Weld

Part #	Mfg #	Size	Type	Price
2701	SW701	1/2"	Socket Weld	84.15
2702	SW701	3/4"	Socket Weld	93.41
2703	SW701	1"	Socket Weld	117.81
2704	SW701	1-1/4"	Socket Weld	330.71
2705	SW701	1-1/2"	Socket Weld	270.97
2706	SW701	2"	Socket Weld	295.37

#### S701 - 800# A105 Forged Swing Check Valves (FNPT)

- Conventional port
- 1975 psi @ 100°F
- Round bolted bonnet
- Horizontal or vertical upward flow
- Swing check
- Hard faced seat
- ASME B16.34



Vogt Valves

IPS

Part #	Mfg #	Size	Type	Price
110469	S701	1/2"	IPS	164.94
110470	S701	3/4"	IPS	197.76
110471	S701	1"	IPS	317.25
110472	S701	1-1/2"	IPS	483.03
110473	S701	2"	IPS	604.20

Socket Weld

Part #	Mfg #	Size	Type	Price
110474	SWS701	1/2"	Socket Weld	164.94
110475	SWS701	3/4"	Socket Weld	197.76
110476	SWS701	1"	Socket Weld	317.25
867746	SWS701	1-1/4"	Socket Weld	607.57
110477	SWS701	1-1/2"	Socket Weld	483.03
110478	SWS701	2"	Socket Weld	604.20

#### B701 - 800# A105 Forged Ball Type Horizontal Lift Check Valves

- Conventional port
- 1975 psi @ 100°F
- Round bolted bonnet
- Spiral wound gasket
- Horizontal type
- Ball check
- Integral seat
- ASME B16.34



Vogt Valves

IPS

Part #	Mfg #	Size	Type	Price
2893	B701	1/2"	IPS	128.75
2894	B701	3/4"	IPS	145.58
2895	B701	1"	IPS	156.52
2896	B701	1-1/4"	IPS	454.96
2897	B701	1-1/2"	IPS	425.80
2898	B701	2"	IPS	477.14

Valves



## Check Valves - Forged Steel

### Socket Weld

Part #	Mfg #	Size	Type	Price
2900	SWB701	3/4"	Socket Weld	145.58
2901	SWB701	1"	Socket Weld	156.52
2902	SWB701	1-1/4"	Socket Weld	156.52
2903	SWB701	1-1/2"	Socket Weld	425.80
2904	SWB701	2"	Socket Weld	477.14

### 710 - 800# A105 Forged Spring Loaded Piston Check Valves

- Conventional port
- 1975 psi @ 100°F
- Spring control
- Round bolted bonnet
- Spiral wound gasket
- Horizontal or vertical upward flow
- Piston check or ball check
- Integral hard faced seat
- ASME B16.34



Vogt Valves

### IPS

Part #	Mfg #	Size	Type	Price
2707	710	1/2"	IPS	135.49
2708	710	3/4"	IPS	153.16
2709	710	1"	IPS	169.15
160221	710	1-1/2"	IPS	422.40
854764	710	2"	IPS	485.76

### IPS with 18% Chromium Trim

Part #	Mfg #	Size	Type	Price
2713	B710	1/2"	IPS	188.50
2714	B710	3/4"	IPS	205.33
2715	B710	1"	IPS	223.84
45026	B710	1-1/2"	IPS	458.62
809617	B710	2"	IPS	Call

### Socket Weld

Part #	Mfg #	Size	Type	Price
2710	SW710	1/2"	Socket Weld	135.49
2711	SW710	3/4"	Socket Weld	153.16
2712	SW710	1"	Socket Weld	169.15
159869	SW710	1-1/2"	Socket Weld	422.40
43266	SW710	2"	Socket Weld	497.33

### 13701 - 800# A105 Forged Piston Check Valves

- Full port
- 1975 psi @ 100°F
- Round bolted bonnet
- Spiral wound gasket
- Horizontal type
- Piston check
- Integral hard faced seat
- ASME B16.34



Vogt Valves

### IPS

Part #	Mfg #	Size	Type	Price
35683	13701	1/2"	IPS	216.27
35684	13701	3/4"	IPS	257.50
35685	13701	1"	IPS	313.04
35687	13701	1-1/2"	IPS	691.72
35688	13701	2"	IPS	895.36

### Socket Weld

Part #	Mfg #	Size	Type	Price
39184	SW13701	1/2"	Socket Weld	216.27
35690	SW13701	3/4"	Socket Weld	257.50
39186	SW13701	1"	Socket Weld	313.04
35693	SW13701	1-1/2"	Socket Weld	691.72
35694	SW13701	2"	Socket Weld	895.36

### SW4835 - 800# A105 Forged Swing Check Valves (Socket Weld) for Horizontal or Vertical Flow

- Conventional port
- 1975 psi @ 100°F
- Round bolted bonnet
- Horizontal or vertical upward flow
- Swing check
- Renewable seat
- ASME B16.34



Vogt Valves

Part #	Mfg #	Size	Type	Price
46179	SW4835	1/2"	Socket Weld	670.68
36236	SW4835	3/4"	Socket Weld	744.48
2788	SW4835	1"	Socket Weld	863.38
114897	SW4835	1-1/4"	Socket Weld	1149.49
2789	SW4835	1-1/2"	Socket Weld	1149.49
2790	SW4835	2"	Socket Weld	1279.93

Valves



## Check Valves - Forged Steel

### 54853 - 800# A105 Forged Inline Ball Check Valves (FNPT)

- Full port
- 1975 psi @ 100°F
- Union bonnet
- Flat gasket joint
- Horizontal or vertical upward flow
- Ball check
- Integral seat
- ASME B16.34



Vogt Valves

Part #	Mfg #	Size	Type	Price
2905	54853	1/2"	IPS	172.51
2906	54853	3/4"	IPS	182.61
2907	54853	1"	IPS	214.59
2909	54853	1-1/2"	IPS	390.46
2910	54853	2"	IPS	525.10

### SW15701 - 1500# A105 Forged Piston Check Valves

- Conventional port
- 3705 psi @ 100°F
- Round bolted bonnet
- Spiral wound gasket
- Horizontal type
- Piston check/ball check
- Integral hard faced seat
- ASME B16.34



Vogt Valves

IPS

Part #	Mfg #	Size	Type	Price
51310	15701	1/2"	IPS	320.62
51311	15701	3/4"	IPS	350.91
51312	15701	1"	IPS	435.90
51313	15701	1-1/2"	IPS	668.16
51314	15701	2"	IPS	881.06

Socket Weld

Part #	Mfg #	Size	Type	Price
51316	SW15701	1/2"	Socket Weld	320.62
51317	SW15701	3/4"	Socket Weld	350.91
51318	SW15701	1"	Socket Weld	435.90
51315	SW15701	1-1/4"	Socket Weld	668.16
51319	SW15701	1-1/2"	Socket Weld	668.16
51320	SW15701	2"	Socket Weld	881.06

### 573 - 150# A105 Forged Check Valves (Flanged)

- Conventional port
- 285 psi @ 100°F
- Round bolted bonnet
- Spiral wound gasket
- Horizontal type
- Integral hard faced seats
- ASME B16.34

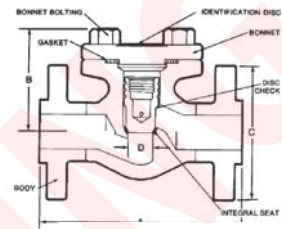

Vogt Valves

Part #	Mfg #	Size	Type	Price
2688	573	1/2"	Flanged	268.44
2689	573	3/4"	Flanged	315.57
2690	573	1"	Flanged	345.86
2691	573	1-1/2"	Flanged	537.72
2692	573	2"	Flanged	797.75

### 583 - 300# A105 Forged Check Valves (Flanged)

- 740 psi @ 100°F
- Piston Check

Part #	Mfg #	Size	Type	Price
51304	583	1/2"	Flanged	304.63
45898	583	3/4"	Flanged	341.65
45899	583	1"	Flanged	374.47
51302	583	1-1/2"	Flanged	582.32
51303	583	2"	Flanged	863.38

### 593 - 600# A105 Forged Check Valves (Flanged)

- 1480 psi @ 100°F
- Piston Check

Part #	Mfg #	Size	Type	Price
51304	593	1/2"	Flanged	304.63
51305	593	3/4"	Flanged	357.64
51306	593	1"	Flanged	391.30
51307	593	1-1/2"	Flanged	608.41
51308	593	2"	Flanged	902.09

Valves



## Check Valves - Forged Steel

### Edwards Check Valves

#### 800# Forged Steel Piston Check Valves

- 2000 psi @ 100°F
- Bodies & covers are of forged steel
- Bolted cover
- Body-guided hardened stainless steel disk
- Integral Stellite seat
- Asbestos-free spiral wound cover gasket

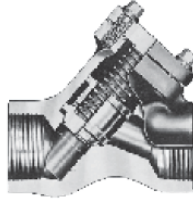

**Edward Valve**

#### 838 Series - Y-Pattern - IPS

Part #	Mfg #	Size	Type	Price
138586	838	1/2"	IPS	316.00
138587	838	3/4"	IPS	363.00
138560	838	1"	IPS	433.00
138588	838	1-1/4"	IPS	977.00
138589	838	1-1/2"	IPS	977.00
138590	838	2"	IPS	1386.00

#### 838Y Series - Y-Pattern - Socket Weld

Part #	Mfg #	Size	Type	Price
138593	838Y	1/2"	Socket Weld	316.00
138594	838Y	3/4"	Socket Weld	363.00
138561	838Y	1"	Socket Weld	433.00
138595	838Y	1-1/4"	Socket Weld	977.00
138596	838Y	1-1/2"	Socket Weld	977.00
138597	838Y	2"	Socket Weld	1386.00

### 1500# Forged Steel Piston Check Valves - (Socket Weld)

- 3600 psi @ 100°F
- Bodies and covers are of forged steel
- Bolted cover
- Body-guided hardened stainless steel disk
- Integral Stellite seat
- Asbestos free spiral wound cover gasket
- Stainless steel spring

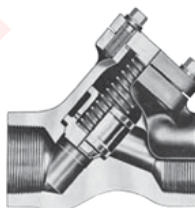

**Edward Valve**

#### 1038 Series - Y-Pattern - Socket Weld

Part #	Mfg #	Size	Type	Price
182626	1038Y	1/2"	Socket Weld	650.00
182627	1038Y	3/4"	Socket Weld	745.00
182628	1038Y	1"	Socket Weld	840.00
182629	1038Y	1-1/2"	Socket Weld	1248.00

### Forged Steel Needle & Indicator Valves

#### 12443 - 800# A105 Forged Globe Valves (FNPT)

- Conventional port
- 1975 psi @ 100°F
- For flow control service
- Round bolted bonnet
- Spiral wound gasket
- Outside screw & yoke
- Bolted gland
- Loose v-port disc
- Integral hard faced seat
- Dial & indicator
- ASME B16.34

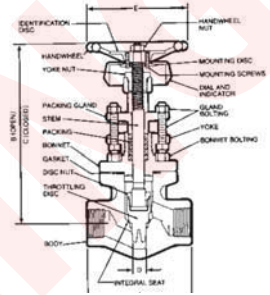

**Vogt Valves**

Part #	Mfg #	Size	Type	Price
2848	12443	1/2"	IPS	350.91
2849	12443	3/4"	IPS	422.44
2850	12443	1"	IPS	488.07

#### 9871T - 5000# A105 Forged Globe Valves (FNPT)

- Type 5000
- Conventional port
- 5000 PSI @ 100°F (344.8 BAR @ 38°C)
- Temperature not to exceed 450°F
- Not recommended for steam or dry gas service.
- Body/Bonnet A105

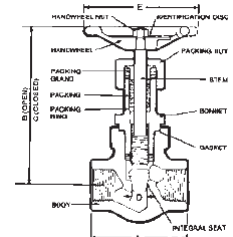

**Vogt Valves**

Part #	Mfg #	Size	Type	Price
2791	9871T	1/4"	IPS	210.80
2792	9871T	3/8"	IPS	175.88
2793	9871T	1/2"	IPS	227.21
2794	9871T	3/4"	IPS	210.38
2795	9871T	1"	IPS	217.95



## Gate Valves - Stainless Steel

### Stainless Steel Gate Valves

#### Powell 1832 Series SS316 200LB Gate Valves

- Corrosion Resistant
- Screwed-in bonnet
- Inside screw rising stem
- Threaded ends
- ASME B16.34



Part #	Mfg #	Size	Type	Price
3040	1832	1/4"	IPS	131.53
3041	1832	3/8"	IPS	104.47
3042	1832	1/2"	IPS	120.61
3043	1832	3/4"	IPS	131.53
3044	1832	1"	IPS	154.80
3045	1832	1-1/4"	IPS	249.29
3046	1832	1-1/2"	IPS	342.83
3047	1832	2"	IPS	354.71

#### Powell 2491 Series SS316 200LB Gate Valves

- Corrosion Resistant
- Bolted flanged yoke bonnet
- Flanged end
- ASME B16.34
- Class 200

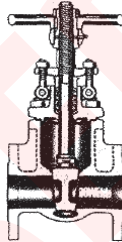

Part #	Mfg #	Size	Type	Price
50324	2491	1/2"	Flanged	Call
46815	2491	3/4"	Flanged	328.85
3075	2491	1"	Flanged	410.99
3076	2491	1-1/2"	Flanged	793.68
3077	2491	2"	Flanged	941.91

#### Powell 2494 Series SS316 200LB Gate Valves

- Corrosion Resistant
- Bolted flanged yoke-bonnet
- Outside screw rising stem
- ASME B16.34
- Class 200



Model 2490 Pictured

Part #	Mfg #	Size	Type	Price
132480	2494SWE	1/2"	Socket Weld	Call
52989	2490SWE	1"	Socket Weld	365.15
52204	2490SWE	1-1/2"	Socket Weld	674.74

### Stainless Steel Gate Valves (Continued)

#### Powell 2494 Series SS316 200LB Gate Valves

Part #	Mfg #	Size	Type	Price
52990	2490SWE	2"	Socket Weld	813.87

#### Vogt 12401 Class 800 Stainless Forged Gate Valves

- Round bolted bonnet
- Spiral wound gasket
- Outside screw & yoke
- Bolted gland
- Solid wedge
- Hard faced seats
- ASME B16.34
- Conventional port
- 1920 PSI @ 100°F

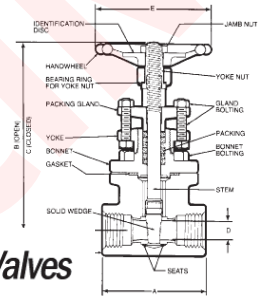

#### 12401 - Flanged

Part #	Mfg #	Size	Type	Price
2834	12401	1/2"	Flanged	321.46
2835	12401	3/4"	Flanged	381.20
2836	12401	1"	Flanged	557.92
221015	12401	1-1/4"	Flanged	Call
2838	12401	1-1/2"	Flanged	867.59
2839	12401	2"	Flanged	1163.80

#### SW12401 - Socket Weld

Part #	Mfg #	Size	Type	Price
2842	SW12401	1/2"	Socket Weld	321.46
2843	SW12401	3/4"	Socket Weld	381.20
2844	SW12401	1"	Socket Weld	557.92
2845	SW12401	1-1/4"	Socket Weld	Call
2846	SW12401	1-1/2"	Socket Weld	867.59
2847	SW12401	2"	Socket Weld	1163.80

#### Powell 2456 Series SS316 150LB Gate Valves

- Flexible Wedge sizes 3" through 48"
- Integral seats
- Class 150
- Bolted flanged yoke-bonnet
- Outside screw rising stem
- Flanged ends



Part #	Mfg #	Size	Type	Price
3056	2456	2-1/2"	Flanged	1172.33
3057	2456	3"	Flanged	1188.05
3058	2456	4"	Flanged	1758.04
54516	2456	6"	Flanged	1917.31

Valves

Prices & specifications are subject to change.

Metropolitan Pipe offers Vendor Managed Inventory - never run out of that part again!





## Gate Valves - Stainless Steel

### Stainless Steel Gate Valves (Continued) Powell 2456 Series SS316 150LB Gate Valves

Part #	Mfg #	Size	Type	Price
124013	2456	8"	Flanged	2884.62
124402	2456	10"	Flanged	Call
234212	2456	12"	Flanged	Call

### Stainless Steel Globe Valves

#### Vogt 12501 Series Class 800 Stainless Steel 316 Forged Globe Valves

- Round bolted bonnet
- Spiral wound gasket
- Outside screw & yoke
- Bolted gland
- Loose disc
- Integral hard faced seat
- ASME B16.34
- Conventional port
- 2000 PSI @ 100°F
- Class 800

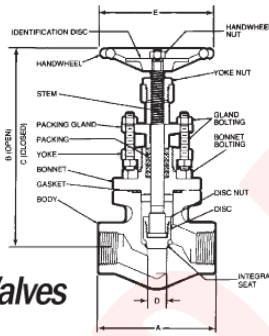

**Vogt Valves**

#### Model 12501 Class 800 - IPS Connections

Part #	Mfg #	Size	Type	Price
201481	12501	1/4"	IPS	Call
2851	12501	1/2"	IPS	415.71
2852	12501	3/4"	IPS	456.10
2853	12501	1"	IPS	718.65
231997	12501	1-1/4"	IPS	Call
2854	12501	1-1/2"	IPS	1337.15
2855	12501	2"	IPS	1682.16

#### Model SW12501 Class 800 - Socket Weld

Part #	Mfg #	Size	Type	Price
917746	SW12501	1/4"	Socket Weld	Call
234030	SW12501	3/8"	Socket Weld	Call
2856	SW12501	1/2"	Socket Weld	415.71
2857	SW12501	3/4"	Socket Weld	456.10
2858	SW12501	1"	Socket Weld	718.65
35680	SW12501	1-1/4"	Socket Weld	Call
35681	SW12501	1-1/2"	Socket Weld	424.12
35682	SW12501	2"	Socket Weld	1682.16

### Edward 1048Y Series Class 1500 F11 Forged Globe Valves

- Bodies and bonnets are of forged steel
- Bolted bonnet, OS & Y.
- Y-Pattern or angle design.
- Body-guided hardened stainless steel
- Integral satellite seat.
- Integral backseat.
- 13% chromium stainless steel stem.
- Asbestos-free graphitic packing.
- Asbestos-free spiral wound bonnet gasket.
- Knobbed hand wheel.
- 3600 PSI @ 100°F
- Series 1500



**Edward Valve**

Part #	Mfg #	Size	Type	Price
241129	1048(F11)Y	1/2"	Socket Weld	763.00
151893	1048(F11)Y	1"	Socket Weld	1248.00
808422	1048(F11)Y	1-1/4"	Socket Weld	1489.00
146542	1048(F11)Y	1-1/2"	Socket Weld	1871.00
151894	1048(F11)Y	2"	Socket Weld	2573.00

### Vogt 1522 Series Class 1690 Forged "Y" Pattern Globe Valves

- Welded bonnet
- Outside screw & yoke
- Bolted gland
- Loose solid satellited Disc
- Integral hard faced seat
- ASME B16.34 LTD pressure class
- Class 1690
- Conventional port
- 4225 PSI @ 100°F

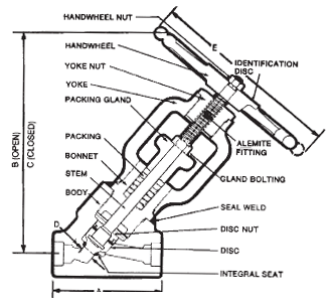

**Vogt Valves**

#### SW1522 Series - Class 1690 - F22 - Socket Weld

Part #	Mfg #	Size	Type	Price
2739	SW1522	1/2"	Socket Weld	669.84
2740	SW1522	3/4"	Socket Weld	669.84
2741	SW1522	1"	Socket Weld	791.86
2742	SW1522	1-1/2"	Socket Weld	1606.43
2743	SW1522	2"	Socket Weld	1788.19

Valves



## Globe Valves - Stainless Steel

### SW2522 Series - Class 2680 - F22 - Socket Weld

- Full Port
- 6700 PSI @ 100°F

Part #	Mfg #	Size	Type	Price
2749	SW2522	1/2"	Socket Weld	846.55
2750	SW2522	3/4"	Socket Weld	1155.38
2751	SW2522	1"	Socket Weld	1155.38
2752	SW2522	1-1/2"	Socket Weld	2478.22
2753	SW2522	2"	Socket Weld	2867.00

### 36124 Series Class 1690 Forged "Y" Pattern Globe Valves

- Available Body Materials
- Unwelded (graphitic seal) or welded bonnet.
- OS & Y.
- Y-Pattern.
- Body-guided investment cast Stellite disk.
- Integral Stellite seat.
- Integral backseat.
- Asbestos-free graphitic packing.
- 4225 PSI @ 100°F
- Class 1690



**Edward Valve**

### 36124 Series - Class 1690 - F22 - Socket Weld

Part #	Mfg #	Size	Type	Price
151601	36124	1/2"	Socket Weld	761.54
151602	36124	3/4"	Socket Weld	866.00
150851	36124	1"	Socket Weld	933.00
151924	36124	1-1/4"	Socket Weld	1855.00
151603	36124	1-1/2"	Socket Weld	2046.00
151925	36124	2"	Socket Weld	2357.00

### 66124 Series - Class 2680 - F22 - Socket Weld

- Class 2680
- 6700 PSI @ 100°F

Part #	Mfg #	Size	Type	Price
Call	66124	1/2"	Socket Weld	Call
151976	66124	3/4"	Socket Weld	1437.00
151977	66124	1"	Socket Weld	1480.00
Call	66124	1-1/4"	Socket Weld	Call
235196	66124	1-1/2"	Socket Weld	Call
151980	66124	2"	Socket Weld	Call

## Stainless Steel Check Valves

### Powell 1847 Series SS316 200LB Swing Check Valves

- Screwed-in cap
- 200 WOG
- 350° F Temperature Rating

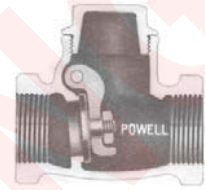

Part #	Mfg #	Size	Type	Price
3059	1847	1/4"	IPS	85.47
3060	1847	3/8"	IPS	85.47
3061	1847	1/2"	IPS	85.47
3062	1847	3/4"	IPS	88.80
3063	1847	1"	IPS	114.91
3064	1847	1-1/4"	IPS	141.51
3065	1847	1-1/2"	IPS	215.58
3066	1847	2"	IPS	366.10

### Powell 2341 Series SS316 200LB Swing Check Valves

- Corrosion resistant swing check
- Bolted flanged cap
- ASME B16.34
- Class 200



Part #	Mfg #	Size	Type	Price
45191	2341	1-1/2"	IPS	498.10
45192	2341	2"	IPS	498.10
40239	2341SWE	1-1/2"	Socket Weld	503.80
40236	2341SWE	2"	Socket Weld	505.23

### Powell 2342 Series SS316 150LB Swing Check Valves

- Corrosion resistant swing check
- Bolted flanged cap
- ASME B16.34
- Class 150



Part #	Mfg #	Size	Type	Price
3034	2342	1"	Flanged	472.53
3035	2342	1-1/2"	Flanged	617.16
3036	2342	2"	Flanged	768.98
3038	2342	3"	Flanged	1114.84
3039	2342	4"	Flanged	1656.08



## Check Valves - Stainless Steel

### Vogt 718 Series 800 Class Forged Check Valves

- Round bolted bonnet
- Spiral wound gasket
- Horizontal or vertical upward flow
- Hard faced seat
- ASME B16.34
- Class 800
- 1975 PSI @ 100°F

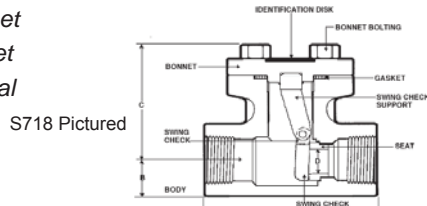

S718 Pictured

### Vogt Valves

#### 718 IPS 800LB Lift Check

Part #	Mfg #	Size	Type	Price
39977	718	1/2"	IPS	408.97
51294	718	3/4"	IPS	440.11
40923	718	1"	IPS	695.08
929479	718	1-1/4"	IPS	Call
40924	718	1-1/2"	IPS	1165.48
51295	718	2"	IPS	1431.40

#### S718 IPS 800LB Swing Check

Part #	Mfg #	Size	Type	Price
119470	S718	1/2"	IPS	536.04
119471	S718	3/4"	IPS	627.76
135475	S718	1"	IPS	864.23
890896	S718	1-1/2"	IPS	1513.02
933478	S718	2"	IPS	2026.34

#### SW718 Socket Weld 800LB Lift Check

Part #	Mfg #	Size	Type	Price
2716	SW718	1/2"	Socket Weld	408.97
2717	SW718	3/4"	Socket Weld	440.11
2718	SW718	1"	Socket Weld	695.08
43771	SW718	1-1/2"	Socket Weld	1165.48
43772	SW718	2"	Socket Weld	1431.40

#### SWS718 Socket Weld 800LB Swing Check

Part #	Mfg #	Size	Type	Price
135476	SWS718	1/2"	Socket Weld	536.04
135477	SWS718	3/4"	Socket Weld	627.76
135478	SWS718	1"	Socket Weld	864.23
135479	SWS718	1-1/2"	Socket Weld	1513.02
135481	SWS718	2"	Socket Weld	2026.34



### Crane Elastomer-Lined Check Valves

- The ductile iron valve body is fully isolated from the line media by the elastomer lining extending the service life of the valve

#### 800 Series - Fully Elastomer-Lined Check Valves

- Bubble-tight shutoff from 25 to 150 psi
- Buna-N or EPDM elastomers standard
- Compatible with ANSI B16.1 125# iron or B16.5 150# steel flanges
- Dual corrosion-resistant springs aid in quick response to flow reversal
- Plate travel stop is elastomer material in 2" through 12" or 316 stainless steel in 14" through 24"
- Ductile iron valve body



Part #	Mfg #	Size	Type	Price
542	800	2"		166.32
543	800	2-1/2"		202.95
544	800	3"		230.67
545	800	4"		266.31
546	800	5"		349.47
547	800	6"		321.75
548	800	8"		489.06
33468	800	10"		777.65

Valves



## Check Valves - Stainless Steel

**CRANE**

### Crane High Performance Check Valves

- Duo-Chek II® hinge design reduces friction forces by 66%
- Support sleeves are inserted through the outboard hinges so that the upper hinge is independently supported by the lower sleeve during valve operation

#### G Series Check Valves - 125#

- Standard design Duo-Chek II® body type, wafer or lug
- Cast iron flange
- Cast iron body with aluminum bronze plate
- Buna-N seal
- Plain face end connections



#### Lug Body Style

- Solid body design with threaded holes bolted from each end
- 316 Stainless steel plate

Part #	Mfg #	Size	Type	Price
200644	G12HMP1-4	2"		133.76
200643	G12HMP1-4	2-1/2"		167.88
200642	G12HMP1-4	3"		184.13
200641	G12HMP1-4	4"		232.32
200636	G12HMP1-4	5"		324.39
200639	G12HMP1-4	8"		535.59
199931	G12HMP1-4	10"		858.34

#### G Series Check Valves - 150#

- Standard design Duo-Chek II® body type, wafer or lug
- Carbon steel body and plate
- Metal seal
- Serrated raised face end connections

#### Wafer Body Style

- Body inserted between mating flanges with studs spanning entire length



Part #	Mfg #	Size	Type	Price
200512	G15SPF	4"		438.11
200518	G15SPF	6"		621.69
200513	G15SPF	8"		912.50

#### Wafer Style with Stainless Steel Plates

- Solid body design with threaded holes bolted from each end
- 316 Stainless steel plate

Part #	Mfg #	Size	Type	Price
200519	G15SPF1-4	6"		656.35
200517	G15SPF1-4	8"		960.15

### U Series Check Valves - 125#

- Underwriters' Laboratories listed valves for fire protection service
- Cast iron flange
- Cast iron body with aluminum bronze plate
- Buna-N seal
- Plain face end connections



#### Wafer Body Style

- Body inserted between mating flanges with studs spanning entire length

Part #	Mfg #	Size	Type	Price
199933	U12HMP	4"		154.88
199934	U12HMP	6"		240.99

Valves

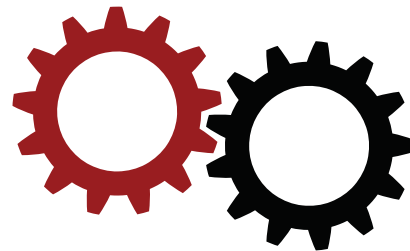

## Valve Actuation

Our in-house valve actuation shop is equipped to add actuators (both pneumatic and electric) to many different sizes and types of valves.



# Butterfly Valves



## Centerline Butterfly Valves

### Series 200 Lug Style

- 2" to 12" - 200 psi, 125 psi for PTFE seat
- 14" to 48" — 150 psi.
- Ideal for on-off or throttling services.
- Designed to comply with MSS SP-67.
- Compatible with ASME B16.1 and ASME B16.5 flanges.
- Vacuum service rating: zero leakage at 24" of mercury.



### Aluminum Bronze Disc - 416SS Stem - EPDM Liner

Part #	Size	Actuator	Price
55165	2"	Lever	112.37
55166	2-1/2"	Lever	122.76
55167	3"	Lever	131.67
55168	4"	Lever	155.43
55169	5"	Lever	196.52
55170	6"	Lever	234.14
55171	8"	Lever	349.47
55192	2"	Gear	Call
55193	2-1/2"	Gear	Call
55194	3"	Gear	230.18
55195	4"	Gear	254.93
55196	5"	Gear	298.49
55197	6"	Gear	Call
55198	8"	Gear	460.35
55199	10"	Gear	643.50
55200	12"	Gear	866.25
55201	14"	Gear	1534.50
56681	16"	Gear	2267.10

### 316 Stainless Steel Disc - 316 Stainless Steel Stem - EPDM Liner

Part #	Size	Actuator	Price
55184	2-1/2"	Lever	150.98
55185	3"	Lever	177.71
55186	4"	Lever	231.66
55188	6"	Lever	391.55

### Ductile Iron Disc - 416 Stainless Steel Stem - EPDM Liner

Part #	Size	Actuator	Price
55175	2-1/2"	Lever	104.94
55176	3"	Lever	109.40
55177	4"	Lever	128.70
55179	6"	Lever	203.94

## Wafer Style

- Wafer body features four alignment holes.
- 2" to 12" - 200 psi, 125 psi for PTFE seat
- 14" to 48" — 150 psi.
- Ideal for on-off or throttling services.
- Designed to comply with MSS SP-67.
- Compatible with ASME B16.1 and ASME B16.5 flanges.
- Vacuum service rating: zero leakage at 24" of mercury.

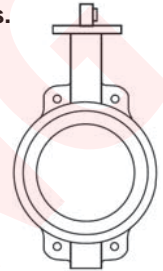

### Aluminum Bronze Disc - 416 Stainless Steel Stem - EPDM Liner

Part #	Size	Actuator	Price
55104	2"	Lever	99.50
55116	2-1/2"	Lever	112.37
55117	3"	Lever	121.28
55118	4"	Lever	136.13
55119	5"	Lever	174.24
55120	6"	Lever	211.37

### 316 Stainless Steel Disc - 316 Stainless Steel Stem - EPDM Liner

Part #	Size	Actuator	Price
55127	2"	Lever	Call
55128	2-1/2"	Lever	132.17
55129	3"	Lever	168.80
55130	4"	Lever	208.89
55131	5"	Lever	Call
55132	6"	Lever	346.50

## Replacement Handles

- Handles are available for on/off and throttling control of Center Line resilient seated butterfly valves.
- These handles can be used for manual actuation of 2" to 12" valves at 200 psi and for 2" to 6" valves at 285 psi.

Part #	Fits Size	Price
42112	2" & 3"	14.36
49497	4"	14.36
49498	5" & 6"	28.85
38033	8"	32.18
42119	10"	24.40

## Gear Operators

- With Hand wheel

Part #	Fits Size	Price
39909	2" & 3"	101.92
49500	4"	120.29

Valves

Prices & specifications are subject to change.

Metropolitan Pipe offers FREE DELIVERY in the Greater Boston area.



# Butterfly Valves



## Centerline Butterfly Valves (Continued) Gear Operators

Part #	Fits Size	Price
49502	5" & 6"	98.08
38793	8"	182.69
37907	10"	154.44



## Nibco Butterfly Valves

### N-200-145 Series 200 PSI Cast Iron Butterfly Valves

- Cast Iron Body
- Extended Neck Cartridge Seat Liner
- Lug Style
- Not Recommended for Steam Service
- EPDM Liner Aluminum Bronze Disc
- Install between Std. ANSI Class 125/150 Flanges
- Conforms to MSS-SP67



Part #	Mfg #	Size	Actuator	Price
139344	N200235LH	2-1/2"	Lever	98.51
139345	N200235LH	3"	Lever	105.90
139346	N200235LH	4"	Lever	125.11
139347	N200235LH	5"	Lever	167.96
139348	N200235LH	6"	Lever	200.96

### GD-4765 Series 300 PSI Grooved End Butterfly Valve

- Polymid coated ductile iron body
- Extended neck elastomer encapsulated disc
- Grooved mechanical style
- Not recommended for steam service
- EPDM liner
- Conforms to MSS-SP67



Part #	Mfg #	Size	Actuator	Price
239657	GD4765-3	2"	Lever	155.82
239658	GD4765-3	2-1/2"	Lever	191.29
239659	GD4765-3	3"	Lever	202.06
239660	GD4765-3	4"	Lever	252.10
239661	GD4765-3	5"	Lever	425.02
239662	GD4765-3	6"	Lever	483.29

**For grooved valves & strainers,  
 see page 474.**

## FLOWSEAL

### Flowseal Butterfly Valves

#### HP Series 150# Straight Shaft - Soft Seat

- Carbon steel body
- 316 Stainless steel disc
- 17-4PH Stainless steel shaft
- TFE seat, Viton® O-ring
- TFE packing material
- Garfil (glass backed TFE) bearing
- MS specification SP-61
- ANSI B16.34

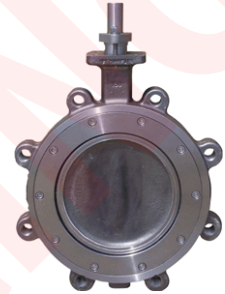

Lugged

Part #	Mfg #	Size	Actuator	Price
55421	03-1LA121TTG-H	3"	Ratchet Handle	1149.00
55422	04-1LA121TTG-H	4"	Ratchet Handle	1351.35
55424	06-1LA121TTG-H	6"	Ratchet Handle	1871.80
55425	08-1LA121TTG-H	8"	Ratchet Handle	2443.52
55426	06-1LA121TTG-3	6"	Worm Gear	2713.10
55427	08-1LA121TTG-3	8"	Worm Gear	2722.11
55428	10-1LA121TTG-3	10"	Worm Gear	4152.46
55429	12-1LA121TTG-3	12"	Worm Gear	5410.95

Wafer

Part #	Mfg #	Size	Actuator	Price
55411	03-1WA121TTG-H	3"	Ratchet Handle	Call
55412	04-1WA121TTG-H	4"	Ratchet Handle	1067.92
55414	06-1WA121TTG-H	6"	Ratchet Handle	1424.81
55415	08-1WA121TTG-H	8"	Ratchet Handle	1988.91

Valves



## Plug Valves - Steel



### Homestead Lubricated Plug Valves

#### Full Port Semi-Steel 125# Plug Valve - (FNPT)

- UL Listed
- Straightway - wrench operated
- Rectangular port
- Cold working pressure: 200 psi WOG
- Steam working pressure: 150 psi



Part #	Mfg #	Size	Type	Wrench	Price
1753	601	1/2"	IPS	F	105.60
1754	601	3/4"	IPS	F	105.60

#### Standard Opening Semi-Steel 125# Plug Valve - (FNPT)

- UL Listed
- Straightway - wrench operated
- Rectangular port
- Cold working pressure: 200 psi WOG
- Steam working pressure: 150 psi



Part #	Mfg #	Size	Type	Wrench	Price
1755	611	1"	FNPT	F	102.08
1756	611	1-1/4"	FNPT	G	111.76
1757	611	1-1/2"	FNPT	G	111.76
1758	611	2"	FNPT	G	107.36
1759	611	2-1/2"	FNPT	E	170.72
1760	611	3"	FNPT	E	191.84
1761	611	4"	FNPT	L	258.72

#### Standard Opening Semi-Steel 125# Plug Valve - (Flanged)

- UL Listed
- Straightway - wrench operated
- Rectangular port
- Cold working pressure: 200 psi WOG
- Steam working pressure: 150 psi



Part #	Mfg #	Size	Type	Wrench	Price
1762	612	2"	Flanged	G	160.16
1763	612	2-1/2"	Flanged	E	210.32
1764	612	3"	Flanged	E	263.12
1765	612	4"	Flanged	L	358.16
1766	612	5"	Flanged	N	732.16
1767	612	6"	Flanged	N	912.56
1768	612	8"	Flanged	N	1647.36

### Plug Valve Wrenches



Part #	Mfg #	Square	Length	Price
1769	F	13/16"	8-1/8"	15.84
1770	G	-	-	21.12
1771	E	1-1/4"	10-1/2"	30.80
1772	L	1-17/32"	10-1/2"	42.24
1773	N	2-1/32"	-	74.80

### Lubricant Sticks

Part #	Mfg #	Description	Price
1774	B6	3/8" Gray, 24/Box	38.72
1775	C6	1/2" Gray, 24/Box	51.92
151640	D6	5/8" Gray, 24/Box	52.80

## Vendor Managed Inventory Program

Metropolitan Pipe can assist you in setting up your own *stockroom* - complete with barcodes for easy tracking.

 Product ID: 454645  
 Kohler 4330-0 Kingston elongated wall-hung bowl with top spud  
  
 Aisle 7 - Shelf B



## Specialty Valves - Fire Protection



### Nibco Fire Protection Valves

#### T-104-O UL/FM 175# WWP Bronze OS&Y Gate Valves (FNPT x FNPT)

- Block pattern
- Screw-over bonnet
- Outside screw & yoke
- Solid wedge
- Fire protection valve, UL listed, FM approved



Part #	Mfg #	Size	Type	Price
216770	T-104-O	1/2"	IPS	Call
164497	T-104-O	3/4"	IPS	178.06
160436	T-104-O	1"	IPS	178.69
2596	T-104-O	1-1/4"	IPS	206.69
2597	T-104-O	1-1/2"	IPS	266.03
2598	T-104-O	2"	IPS	346.71

#### F-607-OTS 175# Iron OS&Y Gate Valves (Flange x Flange)

- Fire protection valve
- UL/ULC Listed
- FMRC Approved
- Resilient wedge
- Epoxy coated interior/exterior
- Bolted bonnet
- Outside screw & yoke
- Pre-grooved stem for supervisory switch mounting



Part #	Mfg #	Size	Type	Price
164500	F-607-OTS	3"	Flanged	426.05
164502	F-607-OTS	4"	Flanged	494.72
164505	F-607-OTS	6"	Flanged	790.08
164504	F-607-OTS	8"	Flanged	1298.13

#### T-103-HC UL/FM 175# WWP Bronze Hose Gate Valves (FNPT x FNPT)

- Cap and chain
- NRS
- Screw-in bonnet
- Solid wedge
- Fire protection valve, UL listed, FM approved



Part #	Mfg #	Size	Type	Price
164498	T-103-HC	2-1/2"	IPS	536.72

#### T-331-HC 300# Bronze Hose Angle Valves (FNPT x Hose)

- Screw-in bonnet
- Renewable disc
- Rising stem



Part #	Mfg #	Size	Type	Price
164558	T-331-HC	2-1/2"	IPS	499.39



## Custom Reporting

Need a year's worth of your purchase history? No problem! Our custom reporting capabilities allow us to get you the information you need – quickly.





## Specialty Valves - Boiler



### Rockford/Eclipse Check Valves

#### 1000 Series - Disc Type Check Valves - (FNPT)

- For use in distribution systems and industrial plants to prevent reverse flow of gas or air - not tight shutoff
- May be mounted horizontally or vertically
- Removable top cover
- Aluminum disc
- Maximum operating temperature: 200°F



Part #	Mfg #	Size	Type	Max Pressure	Price
15326	1005A	1/2"	F x F	70 psig	222.42
15327	1006A	3/4"	F x F	70 psig	129.62
15328	1010A	1"	F x F	60 psig	303.80



### Everlasting Boiler Valves

#### 250# Iron Boiler Valves - Quick Opening

- Lever operated
- Straight-through flow
- Leak proof seal disc has self-lapping action
- Seal-disc has self wiping action
- Maximum blow-off service: 200 psig



#### 4000-A - (FNPT)

Part #	Mfg #	Size	Type	Operating Pressure	Price
49027	4000-A	1"	IPS	250 psig	337.00
1720	4000-A	1-1/4"	IPS	250 psig	413.00
1721	4000-A	1-1/2"	IPS	200 psig	533.00
1722	4000-A	2"	IPS	200 psig	618.00

#### 4001-A - (Flanged)

Part #	Mfg #	Size	Type	Operating Pressure	Price
119934	4001-A	2"	Flanged	200 psig	794.00
43291	4001-A	2-1/2"	Flanged	100 psig	1099.00

### 250# Iron Boiler Valves - Slow Opening

- Hand wheel operated
- Straight-through flow
- Leak proof seal disc has self-lapping action
- Seal-disc has self wiping action
- Hard seat resists erosion
- Maximum blow-off service: 200 psig

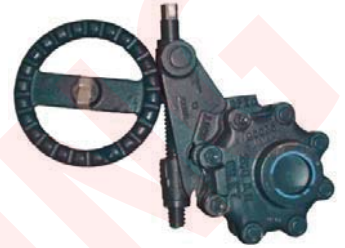

#### 4060-A - (FNPT)

Part #	Mfg #	Size	Type	Operating Pressure	Price
33580	4060-A	2"	IPS	250 psig	955.00



### United Boiler Trim Valves

#### 325U - Y-Blow Down Valves - 300# - Rising Stem - (FNPT)

- Bronze body
- Swivel disc holder
- Stainless steel seat & disc
- Complies with MSS-SP-80-97
- Pressure non-shock: 300 WSP, 600 WOG



Part #	Mfg #	Size	Type	Price
48712	325U	1"	IPS	345.07
48714	325U	1-1/4"	IPS	405.26
48715	325U	1-1/2"	IPS	484.13
48719	325U	2"	IPS	777.91

Valves



## Specialty Valves - Boiler

### Lunkenheimer Bronze Blow-Off Valves

#### 180-T Bronze Blow-Off Valves - 300# - Y-Pattern - (FNPT)

- Union bonnet
- Teflon® disc
- Integral bronze seat ring
- ASTM B61 Type S-1
- Pressure: 300 psi SP



Part #	Mfg #	Size	Type	Price
118134	180-T	1"	IPS	401.08
118137	180-T	1-1/4"	IPS	484.57
118138	180-T	1-1/2"	IPS	636.82
118139	180-T	2"	IPS	918.39

### 1443 Series Steel - Angle

Part #	Mfg #	Size	Type	Material	Price
151912	1443	1-1/2"	Flanged	Cast	2827.00
145308	1443	2"	Flanged	Forged	3650.00
151913	1443	2-1/2"	Flanged	Cast	5443.00

## Edward Valve

### Edwards Blow-Off Valves

- Bolted bonnet, OS & Y
- Integral Stellite seat
- Integral backseat
- 13% Chromium stainless steel stem
- Asbestos free spiral wound bonnet gasket
- Impactor handle
- Size 1-1/2" and 2": bodies & bonnets are forged steel; have hardened stainless steel disk
- Size 2-1/2": bodies and bonnets are cast steel; has Stellite faced disk

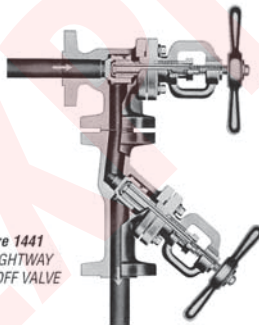
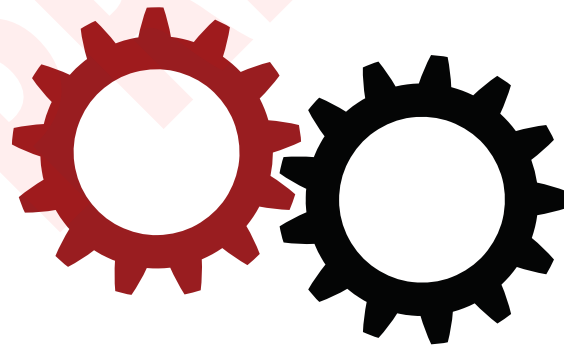

Figure 1443  
ANGLE  
BLOW-OFF VALVE

Figure 1441  
STRAIGHTWAY  
BLOW-OFF VALVE

### 1441 Series Steel - Globe

Part #	Mfg #	Size	Type	Material	Price
151910	1441	1-1/2"	Flanged	Forged	2827.00
145307	1441	2"	Flanged	Forged	3650.00
151911	1441	2-1/2"	Flanged	Cast	5443.00



## Valve Actuation

Our in-house valve actuation shop is equipped to add actuators (both pneumatic and electric) to many different sizes and types of valves.



## Specialty Valves - Instrumentation



### Specialty Valves

#### 60-100 Series 10000 Carbon Steel Globe Bar Stock Valves

- Designed to backseat when fully opened. Back seating the valve helps take the pressure off the packing, thereby prolonging the packing life. The backseat also prevents the stem from being accidentally turned out of the valve.
- Integral metal to metal seat and disc design.
- Body material for socket weld valves is ASTM A108 Steel, Zinc Phosphate finish.
- Pressure Ratings: 10,000 PSIG AT 100°F, WOG.



#### IPS

Part #	Mfg #	Size	Type	Price
112622	60-100-01	1/8"	IPS	Call
1275	60-101-01	1/4"	IPS	55.43
1276	60-102-01	3/8"	IPS	57.16
1277	60-103-01	1/2"	IPS	65.52
1278	60-104-01	3/4"	IPS	109.21
1279	60-105-01	1"	IPS	103.85

#### 70-800 Series Bronze Ball Valve (MNPT x FNPT)

- Eliminates need for extra nipple when connecting to female connection to save time and labor
- Ruggedly built for lasting performance with chromium-plated ball and blowout-proof stem design
- Pressure ratings: 600 psig WOG Cold, non-shock 150 psig Saturated steam
- Vacuum service to 29 inches HG



Part #	Mfg #	Size	Type	Price
33539	70-801-01	1/4" MNPT x FNPT	IPS	15.54
1388	70-803-01	1/2" MNPT x FNPT	IPS	15.54
1387	70-802-01	3/8" MNPT x FNPT	IPS	15.54
156202	70-804-01	3/4" MNPT x FNPT	IPS	26.67

#### 94MBV Brass Mini Ball Valves

- Use as a non-leak gauge cock/test cock
- Perfect for OEM applications
- Reversible handle
- Rugged forged construction
- Blow-out proof stem
- Double Viton® O-rings
- Large raised wrench flats
- Chrome plated brass ball
- Pressure ratings: 600 psi WOG
- Temperature range: -40°F to 300°F



Part #	Mfg #	Size	Type	Price
225412	94-MBV-05	1/8"	F x F	8.25
225413	94-MBV-04	1/8"	F x M	8.61
225411	94-MBV-03	1/4"	F x F	8.25
225410	94-MBV-02	1/4"	F x M	8.61

#### 78-260 Series Brass Instrumentation Ball Valves (MNPT x FNPT)

- Air & liquid service
- Blowout-proof stem design
- Miniature design with micro-finish ball plated steel tee handle
- PTFE seats and a nitrile stem seal
- Pressure ratings: 400 psig WOG Cold, non-shock



Part #	Mfg #	CV	Size	Handle	Price
49127	78-260-05	4.000	1/8" M x F	Tee	11.17
35402	78-261-05	5.500	1/4" M x F	Tee	11.17



### Dragon Globe Valves

#### Model 10M Globe Valves

- 6000 psi @ 200°F
- 2000 psi @ 750°F

#### Carbon Steel (FNPT x FNPT)

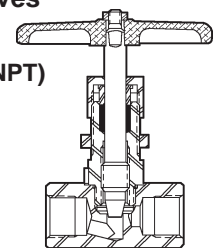

Part #	Mfg #	Size	Price
190305	10M013	1/4"	24.00
190308	10M017	1/2"	29.00
190311	10M0111	3/4"	57.00
190310	10M0115	1"	112.00

Prices & specifications are subject to change.

Our office hours are 7am to 4:30pm and counter hours 6am to 4:30pm Monday through Friday.



## Specialty Valves - Instrumentation

DRAGON VALVES INC.

Stainless Steel (FNPT x MNPT)

- 2000 psi @ 850°F

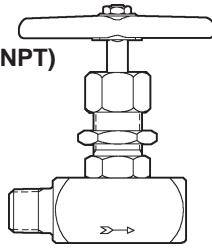

Part #	Mfg #	Size	Price
196632	10M053	1/4"	52.00
196633	10M055	3/8"	56.00
196634	10M057	1/2"	69.00
196635	10M0511	3/4"	158.00

### CRANE

#### Crane Bronze Needle Valves

##### 88 Bronze Globe Valves - 200# - Needle Type Disc - (FNPT)

- Rising stem
- Screwed bonnet
- Integral seat
- Graphite packing
- Working pressures non-shock:  
200 psi Steam, basic rating  
400 psi Cold working pressure

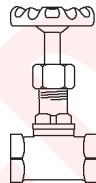

Part #	Mfg #	Size	Type	Price
765	88	1/8"	IPS	71.39
766	88	1/4"	IPS	65.78
767	88	3/8"	IPS	74.22
768	88	1/2"	IPS	83.61
769	88	3/4"	IPS	130.58

##### 89 Bronze Angle Valves - 200# - Needle Type Disc - (FNPT)

- Rising stem
- Screwed bonnet
- Integral seat
- Graphite packing
- Working pressures non-shock:  
200 psi Steam, basic rating  
400 psi Cold working pressure



Part #	Mfg #	Size	Type	Price
770	89	1/8"	IPS	84.54
771	89	1/4"	IPS	74.22
772	89	3/8"	IPS	99.59
773	89	1/2"	IPS	124.01

#### Crane Bronze Needle Valves (Continued)

##### 89 Bronze Angle Valves - 200# - Needle Type Disc - (FNPT)

Part #	Mfg #	Size	Type	Price
774	89	3/4"	IPS	234.85

#### TASCO valves

##### Tasco Flocontrol Valves

##### Bronze 150# Valves - Rising Stem - (FNPT)

- ASTM B-62
- 500 Brinell stainless steel & 13% chrome seat & disc
- 4 V-Port valve
- Non-shock pressure:  
150 psi @ 358°F WSP,  
300 psi @ 100°F WOG

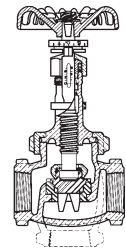

##### Globe Valves

Part #	Mfg #	Size	Type	Price
35005	4445	1/4"	IPS	396.00
33262	4445	1/2"	IPS	447.00
35008	4445	3/4"	IPS	516.00
35009	4445	1"	IPS	722.00

##### Angle Valves

Part #	Mfg #	Size	Type	Price
54964	4455	1/2"	IPS	468.00
54965	4455	3/4"	IPS	537.00
54966	4455	1"	IPS	758.00

##### Bronze 300# Valves - Rising Stem - (FNPT)

- ASTM B-61
- 500 Brinell stainless steel & 13% chrome seat & disc
- 4 V-Port valve
- Non-shock pressure:  
300 psi @ 550°F WSP,  
600 psi @ 100°F WOG

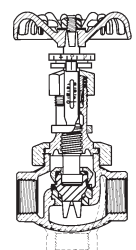

##### Globe Valves

Part #	Mfg #	Size	Type	Price
35016	4585	1/4"	IPS	580.00
35017	4585	3/8"	IPS	582.00
35018	4585	1/2"	IPS	650.00
35019	4585	3/4"	IPS	746.00
35020	4585	1"	IPS	1049.00

Valves



## Specialty Valves - Instrumentation

TASCO valves

### Angle Valves

Part #	Mfg #	Size	Type	Price
54967	4595	1/2"	IPS	683.00
54968	4595	3/4"	IPS	785.00
54969	4595	1"	IPS	1106.00

### Instrumentation Globe Valves

#### 9871T - 5000# A105 Forged Needle Meter-Style Globe Valves (FNPT)

- Conventional port
- 5000 psi @ 100°F
- For meter & gauge line service
- Screw bonnet
- Flat gasket joint
- Inside screw stem
- Screw gland
- Needle point control



Part #	Mfg #	Size	Type	Price
2791	9871T	1/4"	IPS	210.80
2792	9871T	3/8"	IPS	175.88
2793	9871T	1/2"	IPS	227.21
2794	9871T	3/4"	IPS	210.38
2795	9871T	1"	IPS	217.95
812032	9871T	1-1/2"	IPS	Call

**Electronic Billing**

Save time and get your invoices faster online, by email or fax!

Sign up today:  
<http://ebilling.metpipe.com>

Valves



## Specialty Valves



### A Y McDonald Industrial Radiator & Steam Valves

#### Steam/Water Radiator Angle Valves - Rising Stem - (FNPT x Male Union)

- Heavy-duty cast brass
- Buna-M seat and retainer EPDM
- Teflon packing PTFE
- 15 psi WSP
- 60 psi circulated hot water rating



Part #	Mfg #	Size	Price
1212	4431T	1/2"	19.76
1213	4431T	3/4"	24.75
1214	4431T	1"	31.61
1215	4431T	1-1/4"	40.96
1216	4431T	1-1/2"	57.18

#### Steam Radiator Gate Valves - Non-Rising Stem - (FNPT x Male Union)

- Heavy-duty cast bronze
- Teflon packing PTFE
- 15 psi WSP
- 60 psi WOG non-shock



Part #	Mfg #	Size	Price
1207	4435T	1/2"	32.44
1209	4435T	3/4"	45.74
1209	4435T	1"	45.74
1210	4435T	1-1/4"	63.21

#### Hot Water Angle Radiator Valves - Rising Stem - (IPS x Male Union)

- Heavy-duty cast brass
- Buna-M seat and retainer EPDM
- Teflon packing PTFE
- 15 psi WSP
- 60 PSI hot water for gravity systems



Part #	Mfg #	Size	Price
1249	4437S	3/4"	25.58
1250	4437S	1"	37.01

### Hoffman 185 Series Angle Radiator Valves (IPS x Male Union)

- Suitable for hot water, cold water or steam
- Brass / bronze construction
- Non-rising stem; packless construction
- Maximum working pressure: 150 PSIG
- Maximum temperature: 400° F



**Hoffman  
SPECIALTY**

Part #	Mfg #	Size	Price
46441	185	1/2"	74.64
38708	185	3/4"	87.96
176873	185	1"	111.95
181737	185	1-1/4"	156.37
200624	185	1-1/2"	Call

### A Y McDonald Gas Cocks - Boston Style Bronze Square Head with Check - 2 to 5 psi (FIP x FIP)

- Plug style
- Boston pattern
- Double stake nut

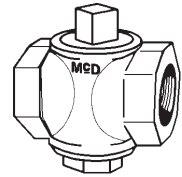

Part #	Mfg #	Size	Type	Notes	Price
1728	10584	1/4"	IPS		11.02
1730	10584	1/2"	IPS	CSA Approved	17.38
1731	10584	3/4"	IPS	CSA Approved	21.30
1732	10584	1"	IPS		41.08
1733	10584	1-1/4"	IPS		58.99
1734	10584	1-1/2"	IPS		83.60
1735	10584	2"	IPS		136.54

**NIBCO**  
AHEAD OF THE FLOW™

### Nibco Stop & Waste Valves

#### 777 Cast Copper Angle Stop & Waste Valves - (Cop x Cop)

- CSA Approved and IAPMO listed
- Buna-N seat disc
- 125 psi CWP to 100°F
- Maximum temperature: 180°F



Part #	Mfg #	Size	Type	Price
3330	ND54006	1/2"	C x C	10.80

Valves

Prices & specifications are subject to change.



## Specialty Valves

Quality Since 1911

HAMMONDVALVE

### Hammond Domestic Stop & Waste Valves

#### 546 Brass Domestic Stop & Waste Valve - (Sweat x Sweat)

- Heavy-duty pattern
- Drainable body
- Malleable iron hand wheel
- Large water ways
- Adjustable packing nut & stuffing box
- Buna-N seats
- Pressure rating non-shock: 150 psi WWP to 200°F

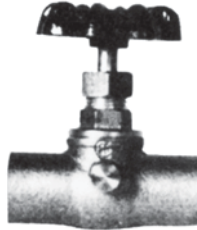

Part #	Mfg #	Size	Type	Price
3323	546	1/2"	C x C	7.79
3324	546	3/4"	C x C	5.96

### 1034 Brass Sill Faucet Hose End Valve - (Sweat x Hose)

- Heavy-duty pattern
- Iron hand wheel
- Adjustable packing nut & stuffing box
- Large water ways
- Buna-N seat
- Pressure rating non-shock: 150 psi WWP to 200°F



Part #	Mfg #	Size	Type	Price
3336	1034	1/2"	Sweat x Hose	6.41
3337	1034	3/4"	Sweat x Hose	6.75



### Hammond Hose End Valves

#### 710 Brass Boiler Drain Hose End Valve (MIP x Hose)

- Heavy-duty pattern
- Iron hand wheel
- Large water ways
- Adjustable packing nut & stuffing box
- Buna-N seat
- Pressure rating non-shock: 150 psi WWP to 200°F



Part #	Mfg #	Size	Type	Price
3335	710	1/2"	MIP x Hose	5.72
3334	710	3/4"	MIP x Hose	6.10

### Raven Brass Boiler Drain Valves (MNPT x Sweat)

- Full port
- Packing nut
- Angled spout



Part #	Mfg #	Size	Handle	Price
809812	12BDBT	1/2"	1/4-Turn Tee	5.90
866149	34BDBT	3/4"	1/4-Turn Tee	7.90

### 1032 Brass Sill Faucet Hose End Valve - (FIP x Hose)

- Heavy-duty pattern
- Iron hand wheel
- Adjustable packing nut & stuffing box
- Large water ways
- Buna-N seat
- Pressure rating non-shock: 150 psi WWP to 200°F



Part #	Mfg #	Size	Type	Price
3338	1032	1/2"	FIP x Hose	6.25
3339	1032	3/4"	FIP x Hose	6.53

Valves

Prices & specifications are subject to change.

We offer a variety of GREEN products such as flush valves, faucets, showerheads & more!



## Specialty Valves

### Strataflow Foot Valves

- 1-Piece cast brass body
- Helically wound stainless steel spring wire strainer
- Working pressure: 200 psi
- Maximum temperature: 225°F



#### 200 Series Bronze Foot Valve

- Silicone treated Buna-S rubber poppet on brass stem
- All purpose foot valve for multiple applications including cold water, ethylene and glycol

Part #	Mfg #	Size	Type	Price
1152	200	3/4"	IPS	25.30
1153	200	1"	IPS	30.54
1154	200	1-1/4"	IPS	34.48
1155	200	1-1/2"	IPS	41.85
1156	200	2"	IPS	66.09



### Jomar Add-A-Valve®

Emergency shutoff device for copper tubing eliminates shutdowns. Allows replacement of defective valve or installation

of new valve in hot or cold water in 30 minutes or less without shutting off water.

- Valve may be replaced or installed on hot (220°F/104°C) or cold water, H<sub>2</sub>O Glycol Systems, under pressure, from 0 to 250 PSI/17 bar Max., on type M, L & K, copper tube.
- Eliminates facility shutdowns
- Available in six sizes ranging from 1/2" to 2"
- Bottom cleanout cap serves as line tap
- Gore-Tex® PTFE tape seal and "Tighter-Than-Tite"™ OR Loc-Tite® gasket sealant included



Part #	Mfg #	Size	Price
1162	800-103ADD	1/2"	198.08
1163	800-104ADD	3/4"	348.08
1164	800-105ADD	1"	445.83
33478	800-106ADD	1-1/4"	859.62
33479	800-107ADD	1-1/2"	984.62
33480	800-108ADD	2"	1634.62

Valves



## Join our e-mail newsletter!

Receive special deals and promotions, new product announcements, contests and more in your inbox every month!

Prices & specifications are subject to change.





## Valve Accessories

### Adjustable Sprocket Chainwheels

- Cast iron
- Made of ASTM B62 marine bronze, chainwheels permit actuation of valves by operators by means of corrosion resistant chain, making valve operation safer



Part #	Mfg #	Size	Handwheel Outside Dia	Price
532	CIRG-0	#0	2" - 4"	45.25
533	CIRG-1	#1	4-1/4" - 5-3/4"	62.25
534	CIRG-1.5	#1-1/2	6" - 7-1/2"	75.25
535	CIRG-2	#2	7-3/4" - 9"	99.00
536	CIRG-2.5	#2-1/2	9-1/4" - 12-1/2"	142.00
537	CIRG-3	#3	12-3/4" - 15-1/2"	165.00
538	CIRG-3.5	#3-1/2	15-3/4" - 19"	250.00
539	CIRG-4	#4	19-1/4" - 22"	336.00
47865	CIRG-4.5	4-1/2	22-1/4" - 26"	535.00

### Chain

#### Hot Dipped Galvanized Chain

- Single loop, lock link chain for adjustable sprocket chainwheels
- Weldless with sheared ends
- Not heat treated



Part #	Mfg #	Chain Size	Working Load Limit	Price
528	GC-0	#2	155 lbs	1.00
529	GC-1	#1/0	265 lbs	1.20
530	GC-2.5	#4/0	485 lbs	1.70
531	GC-4	#5/0	580 lbs	1.95

### MasterLink

- Single loop, lock link chain for adjustable sprocket chainwheels



ML-1



ML-2.5



ML-4

Part #	Mfg #	Chain Size	Price
182046	ML-1	#1/0	10.04
182045	ML-2.5	#4/0	11.00
182047	ML-4	#5/0	12.44

### Carbon Steel Attachment Sets for Chainwheels

- For adjustable sprocket chainwheels



Part #	Mfg #	Description	Price
117392	ATSTL-1.5	#1-1/2 Chain Operator	15.00



### High Temperature/Pressure Steam Packing

- Corrosion-inhibited square valve stem packing designed for steam valve service commonly related to power generation
- Braided jacket of "S2" fiberglass with Inconel® wire inserted over a non-hardening core material
- Steam temperature: up to 1200°F
- Pressure: up to 4300 psi
- pH Range: 2 to 12 (non-buffered solutions)

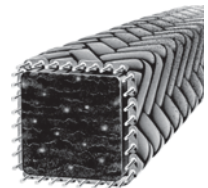

Part #	Mfg #	Size	Price
33464	3871	1/4"	3.87
33465	3871	5/16"	3.37
33466	3871	3/8"	6.20
33467	3871	1/2"	5.45



1•800•MetPipe  
[www.MetPipe.com](http://www.MetPipe.com)

## Custom Pipe Markers WHILE YOU WAIT!

Along with a large line of Brady pipe marking products, **Metropolitan Pipe** now offers custom pipe labels which are created on-site, while you wait!

Need it delivered? Order by 4pm, and your order will ship out the next day. We offer **FREE DELIVERY** in the Greater Boston area.





# Pipe & Valve Identification

## Pipe & Valve Identification

### Pre-made Pipe Markers

**HOT WATER SUPPLY**

- 5 per pack
- Factory applied industrial grade adhesives simplify marker installation
- Arrow Tape is recommended to indicate contents flow direction and to secure markers to the pipe

Part #	Mfg #	Pipe Size	Element	Price
900373	103548	3/4" - 2-3/8"	Domestic Cold Water	10.52
900377	103553	2-1/2" x 7-7/8"	Domestic Cold Water	10.52
900379	103545	3/4" - 2-3/8"	Natural Gas	10.52
900368	103550	2-1/2" x 7-7/8"	Natural Gas	10.52
900372	103547	3/4" - 2-3/8"	Non-potable	10.52
900376	103552	2-1/2" x 7-7/8"	Potable Water	10.52
900374	103549	3/4" - 2-3/8"	Hot Water	10.52
900378	103554	2-1/2" x 7-7/8"	Hot Water	10.52
901510	103546	3/4" - 2-3/8"	Protection Water	10.52
900375	103551	2-1/2" x 7-7/8"	Protection Water	10.52

### Directional Flow Arrow Tape

- Banding pipes with Directional Flow Arrow Tape can enhance safety and improve operating efficiency.
- Durable B-946 material withstands the elements indoors or out
- Provides 360° visibility
- Supplied in liner-mounted rolled form - marker



Part #	Mfg #	Size	Color	Price
915004	91415	1" x 30yds	Black / Gray	27.07
915003	91413	1" x 30yds	Black / White	27.07
120291	91424	1" x 30yds	Black / Yellow	27.07
187175	91427	1" x 30yds	White / Blue	27.07
120295	91425	1" x 30yds	White / Green	27.07
898635	91426	1" x 30yds	White / Red	27.07
44352	91420	2" x 30yds	Black / Yellow	54.07
44353	91421	2" x 30yds	White / Green	54.07
859679	91422	2" x 30yds	White / Red	54.07

Label Size Guide	Outside Diameter of Pipe	Size of Letters
	3/4" to 1-1/4"	1/2"
	1-1/2" to 2"	3/4"
	2-1/2" to 6"	1-1/4"
	8" to 10"	2-1/2"
	Over 10"	3-1/2"

## Roll Form Markers

- Eliminates need for precise measurement of pipe diameter simply cut to the size you need from 30' long roll
- B-946 material adheres to itself for easy wrap-around marker installation
- Legend repeats 65 times per roll
- 8" x 30'



Part #	Mfg #	Description / Element	Price
919237	41466	Hot Water Supply	87.81
919239	41465	Hot Water Return	87.81
919240	41518	Chilled Water	87.81
919642	41512	Cold Water	87.81
919639	41510	Hot Water	87.81
919638	41521	Condensate	87.81
919640	41511	Natural Gas	87.81
919241	41517	Supply	87.81
919641	41515	Return	87.81

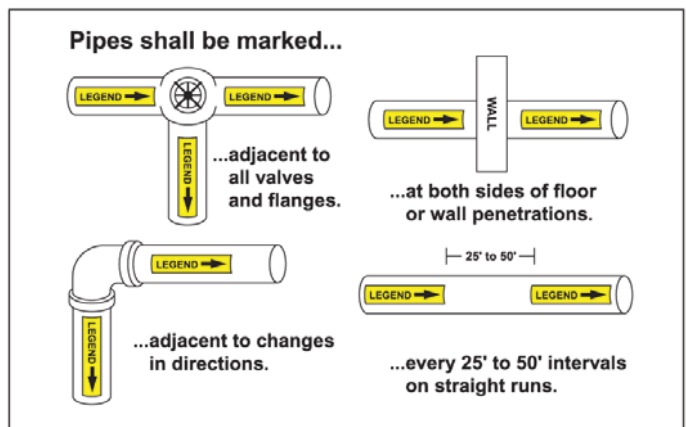
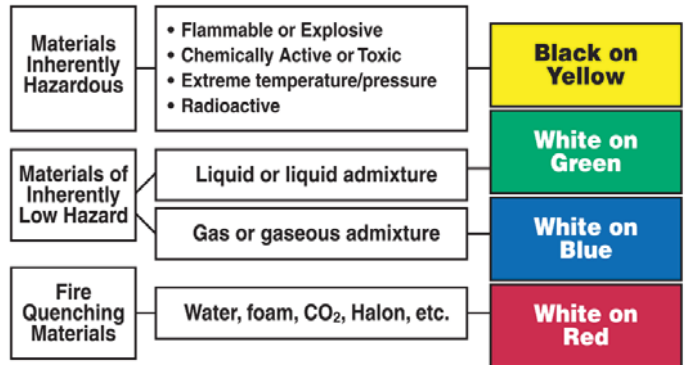



## Pipe & Valve Identification

### Stamped Brass Valve Tags (Numbered)

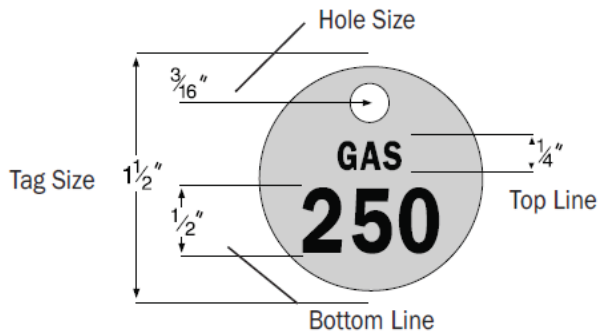

- 19 gauge cartridge brass (40 mils thick)
- 1-1/2" diameter
- Black filled text for easy readability
- Standard package: 25 identical tags

Part #	Mfg #	Size	Numbered	Text	Price
119973	23200	1-1/2"	1-25	Blank	35.60
119374	23201	1-1/2"	26-50	Blank	35.60
185357	23202	1-1/2"	51-75	Blank	35.60
185358	23203	1-1/2"	76-100	Blank	35.60
904731	23204	1-1/2"	101-125	Blank	35.60
904732	23205	1-1/2"	126-150	Blank	35.60
136182	23210	1-1/2"	-	Blank	14.04
117878	23647	1-1/2"	1-25	COND	35.60
138699	23648	1-1/2"	26-50	COND	35.60
909976	87100	1-1/2"	1-25	CWR	35.60
909977	87101	1-1/2"	26-50	CWR	35.60
909978	87120	1-1/2"	1-25	CWS	35.60
909979	87121	1-1/2"	26-50	CWS	35.60
56286	23264	1-1/2"	1-25	GAS	35.60
56288	23265	1-1/2"	26-50	GAS	35.60
56297	23276	1-1/2"	1-25	HW	35.60
56298	23277	1-1/2"	26-50	HW	35.60
56302	23536	1-1/2"	1-25	HWR	35.60
56303	23637	1-1/2"	26-50	HWR	35.60
138704	23556	1-1/2"	1-25	HWS	35.60
145195	23557	1-1/2"	26-50	HWS	35.60
136356	23260	1-1/2"	1-25	PLBG	35.60
909981	23261	1-1/2"	26-50	PLBG	35.60
909980	87500	1-1/2"	1-25	VAC	35.60
909983	87501	1-1/2"	26-50	VAC	35.60

### Valve Tags - Hooks & Chains



Part #	Mfg #	Description	Price
52893	23305	Brass S-Hook (100ea)	32.98
52601	23306	Beaded Chain (100ea - 4-1/2")	21.61
52894	23308	Brass Jack Chain (50ft)	44.94

### Valve Lockouts

- Restricts access to valves
- Red
- Gate lockout  
Polypropylene  
legend: danger locked out do not remove
- Ball lockout  
Steel



Part #	Mfg #	Description	Price
900508	103535	Gate Valve Lockout	17.21
900510	103536	Ball Valve Lockout	25.20



## Pipe

### Standard Brass Pipe

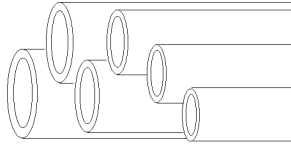

Std Brass Pipe - 12' Lengths

Part #	Size	Price
8	1/8"	5.15
9	1/4"	8.44
10	3/8"	10.54
11	1/2"	15.59
12	3/4"	21.01
13	1"	29.18
14	1-1/4"	43.12
15	1-1/2"	51.30
16	2"	67.76
17	2-1/2"	81.18
18	3"	140.76
19	4"	176.97

### Brass Fittings



#### Threaded Brass Fittings

#### Threaded Plugs - Cored Square Head - Brass



Part #	Size	Price
3691	1/2"	5.28
3692	3/4"	6.64
3693	1"	10.60
3694	1-1/4"	14.87
3695	1-1/2"	18.56
3696	2"	30.47
3697	2-1/2"	51.68
3698	3"	82.15
3699	4"	153.75

#### Threaded Plugs Hex Countersunk

Part #	Size	Price
117396	1/8"	7.58
117400	3/8"	7.58
117402	1/2"	7.58

#### Threaded Barstock Plugs - Solid Square Head

Part #	Size	Price
3688	1/8"	6.64
3689	1/4"	6.64
3690	3/8"	6.64

#### Threaded Face Bushings - Brass



Part #	Size	Price
3515	1/2" x 3/8"	9.29
3516	3/4" x 1/8"	6.77
3518	3/4" x 3/8"	6.77
3519	3/4" x 1/2"	11.67
3523	1" x 3/4"	8.57

#### Threaded Hex Bushings - Brass



Part #	Size	Price
3466	1/4" x 1/8"	5.85
3467	3/8" x 1/8"	5.85
3468	3/8" x 1/4"	5.85
3469	1/2" x 1/8"	7.36
3470	1/2" x 1/4"	5.85
3471	1/2" x 3/8"	5.85
3472	3/4" x 1/8"	7.36
3473	3/4" x 1/4"	7.36
3474	3/4" x 3/8"	7.36
3475	3/4" x 1/2"	7.36
3477	1" x 1/4"	10.64
3478	1" x 3/8"	10.64
3479	1" x 1/2"	9.32
3480	1" x 3/4"	9.32
3483	1-1/4" x 1/2"	19.85
3484	1-1/4" x 3/4"	15.88
3485	1-1/4" x 1"	15.88
3488	1-1/2" x 1/2"	22.56
3489	1-1/2" x 3/4"	22.56
3490	1-1/2" x 1"	22.56
3491	1-1/2" x 1-1/4"	22.56
3492	2" x 1/2"	27.84
3493	2" x 3/4"	27.84
3494	2" x 1"	27.84
3495	2" x 1-1/4"	27.84

#### Threaded Hex Bushings - Brass (Continued)

Part #	Size	Price
3496	2" x 1-1/2"	27.84
3497	2-1/2" x 3/4"	70.25
3498	2-1/2" x 1"	70.25
3499	2-1/2" x 1-1/4"	70.25
3500	2-1/2" x 1-1/2"	70.25
3501	2-1/2" x 2"	70.25
3502	3" x 1"	103.41
3503	3" x 1-1/4"	103.41
3504	3" x 1-1/2"	103.41
3505	3" x 2"	103.41
3506	3" x 2-1/2"	103.41
3507	4" x 2"	267.11
3509	4" x 3"	267.11

#### Threaded Caps - Brass



Part #	Size	Price
3676	1/8"	5.28
3677	1/4"	5.28
3678	3/8"	5.28
3679	1/2"	5.28
3680	3/4"	6.64
3681	1"	12.03
3682	1-1/4"	21.20
3683	1-1/2"	27.84
3684	2"	47.72
3685	2-1/2"	91.55
3686	3"	141.55
3687	4"	269.89

#### Threaded Couplings - Brass



Part #	Size	Price
3426	1/8"	6.64
3427	1/4"	6.64
3428	3/8"	6.64
3429	1/2"	6.64
3430	3/4"	9.32
3431	1"	15.88
3432	1-1/4"	26.51
3433	1-1/2"	34.48

Prices & specifications are subject to change.

Metropolitan Pipe offers Vendor Managed Inventory - never run out of that part again!



## Brass Fittings



## Brass Fittings

### Threaded Couplings - Brass (Continued)

Part #	Size	Price
3434	2"	57.00
3435	2-1/2"	97.11
3436	3"	134.59

### Threaded Coupling Reducers - Brass



Part #	Size	Price
3438	1/4" x 1/8"	7.93
3439	3/8" x 1/8"	7.93
3440	3/8" x 1/4"	7.93
3441	1/2" x 1/8"	9.77
3442	1/2" x 1/4"	7.93
3443	1/2" x 3/8"	7.93
3445	3/4" x 1/4"	10.60
3446	3/4" x 3/8"	10.60
3447	3/4" x 1/2"	10.60
3449	1" x 3/8"	19.75
3450	1" x 1/2"	17.24
3451	1" x 3/4"	17.24
3453	1-1/4" x 1/2"	37.70
3454	1-1/4" x 3/4"	49.47
3455	1-1/4" x 1"	43.75
3456	1-1/2" x 1/2"	49.47
3457	1-1/2" x 3/4"	49.47
3458	1-1/2" x 1"	43.75
3459	1-1/2" x 1-1/4"	43.75
3460	2" x 1/2"	70.43
3461	2" x 3/4"	76.56
3462	2" x 1"	76.56
3463	2" x 1-1/4"	70.88
3464	2" x 1-1/2"	70.88
35936	2-1/2" x 2"	119.28

### Threaded Crosses - Brass

Part #	Size	Price
3668	1/4"	19.44
3669	3/8"	19.44
3670	1/2"	19.44
3671	3/4"	27.75
3672	1"	45.81
3673	1-1/4"	77.52

### Threaded Crosses - Brass (Continued)

Part #	Size	Price
3674	1-1/2"	91.59
3675	2"	183.17

### Threaded 45° Elbows - Brass



Part #	Size	Price
3591	1/8"	9.74
3592	1/4"	9.74
3593	3/8"	9.74
3594	1/2"	9.74
3595	3/4"	13.84
3596	1"	23.60
3597	1-1/4"	37.47
3598	1-1/2"	47.17
3599	2"	76.29
3600	2-1/2"	145.67
3601	3"	224.47
3602	4"	382.87

### Threaded 45° Street Elbows - Brass

Part #	Size	Price
3604	1/4"	12.52
3605	3/8"	12.52
3606	1/2"	12.52
3607	3/4"	18.05
3608	1"	30.51
3609	1-1/4"	47.17
3610	1-1/2"	61.07
3611	2"	109.60

### Threaded 90° Elbows - Brass



Part #	Size	Price
3548	1/8"	7.93
3549	1/4"	7.93
3550	3/8"	7.93
3551	1/2"	7.93
3552	3/4"	10.60
3553	1"	17.24

### Threaded 90° Elbows - Brass (Continued)

Part #	Size	Price
3554	1-1/4"	27.84
3555	1-1/2"	34.48
3556	2"	55.64
3557	2-1/2"	134.59
3558	3"	205.56
3559	4"	416.18

### Threaded 90° Reducing Elbows - Brass

Part #	Size	Price
3560	1/4" x 1/8"	10.88
3561	3/8" x 1/8"	10.88
3562	3/8" x 1/4"	11.83
3564	1/2" x 1/4"	12.70
3565	1/2" x 3/8"	12.70
3566	3/4" x 1/4"	15.12
3567	3/4" x 3/8"	15.12
3568	3/4" x 1/2"	15.12
3569	1" x 3/8"	24.39
3570	1" x 1/2"	26.51
3571	1" x 3/4"	26.51
3572	1-1/4" x 1/2"	37.04
3573	1-1/4" x 3/4"	40.26
3574	1-1/4" x 1"	40.26
3576	1-1/2" x 3/4"	51.33
3577	1-1/2" x 1"	51.33
3578	1-1/2" x 1-1/4"	51.33
3579	2" x 1"	91.55
3580	2" x 1-1/4"	91.55
3581	2" x 1-1/2"	91.55

### Threaded 90° Street Elbows - Brass



Part #	Size	Price
3582	1/8"	10.60
3583	1/4"	10.60
3584	3/8"	10.60
3585	1/2"	10.60
3586	3/4"	14.59
3587	1"	23.88
3588	1-1/4"	43.75



## Brass Fittings



**Brass Fittings**

### Threaded 90° Street Elbows - Brass (Continued)

Part #	Size	Price
3589	1-1/2"	47.72
3590	2"	80.87

### Threaded 90° Union Elbow



- Male union outlet

Part #	Size	Price
1257	3/4"	8.32
1258	1"	28.59
1259	1-1/4"	36.74

### Threaded Companion Flanges - Brass 150#

Part #	Size	Price
3767	1" x 4-1/4"	152.79
3768	1-1/4" x 4-5/8"	190.88
3769	1-1/2" x 5"	221.30
3770	2" x 6"	282.52
3771	2-1/2" x 7"	363.23
3772	3" x 7-1/2"	448.99
3773	4" x 9"	643.17

### Threaded Locknuts - Brass



Part #	Size	Price
3709	1/8"	5.53
3710	1/4"	5.08
3711	3/8"	5.53
3712	1/2"	5.53
3713	3/4"	6.64
3714	1"	10.64
3715	1-1/4"	15.12

### Threaded Tees - Brass



Part #	Size	Price
3612	1/8"	9.32
3613	1/4"	9.32

### Threaded Tees - Brass (Continued)

Part #	Size	Price
3614	3/8"	9.32
3615	1/2"	9.32
3616	3/4"	13.23
3617	1"	23.88
3618	1-1/4"	41.09
3619	1-1/2"	46.40
3620	2"	76.90
3621	2-1/2"	183.12
3622	3"	279.97
3623	4"	694.71

### Threaded Reducing Tees - Brass

Part #	Size	Price
3625	3/8" x 3/8" x 1/4"	13.84
3645	1/2" x 1/4" x 1/4"	16.32
3626	1/2" x 1/2" x 1/4"	13.84
3627	1/2" x 1/2" x 3/8"	13.84
3649	3/4" x 1/2" x 1/2"	17.71
3650	3/4" x 1/2" x 3/4"	16.63
3629	3/4" x 3/4" x 3/8"	16.63
3630	3/4" x 3/4" x 1/2"	16.63
3651	1" x 1/2" x 1"	38.92
3652	1" x 3/4" x 1/2"	35.35
3653	1" x 3/4" x 3/4"	38.43
3654	1" x 3/4" x 1"	36.08
3631	1" x 1" x 1/2"	36.08
3632	1" x 1" x 3/4"	36.08
3633	1-1/4" x 1-1/4" x 1/2"	51.33
3634	1-1/4" x 1-1/4" x 3/4"	51.33
3635	1-1/4" x 1-1/4" x 1"	51.33
3636	1-1/2" x 1-1/2" x 1/2"	70.76
3637	1-1/2" x 1-1/2" x 3/4"	70.76
3638	1-1/2" x 1-1/2" x 1"	70.76
3639	1-1/2"x1-1/2"x1-1/4"	70.76
3640	2" x 2" x 3/4"	115.15
3641	2" x 2" x 1"	115.15
3642	2" x 2" x 1-1/4"	115.15
3643	2" x 2" x 1-1/2"	115.15

### Threaded Bullhead Tees - Brass

Part #	Size	Price
3657	3/8" x 3/8" x 1/2"	17.02
3659	1/2" x 1/2" x 3/4"	15.01
3662	1" x 1" x 1-1/4"	58.64

### Threaded Unions - Brass



Part #	Size	Price
3536	1/8"	22.56
3537	1/4"	22.56
3538	3/8"	22.56
3539	1/2"	22.56
3540	3/4"	31.02
3541	1"	46.76
3542	1-1/4"	67.65
3543	1-1/2"	80.58
3544	2"	108.57
3545	2-1/2"	327.16
3546	3"	507.91
3547	4"	1121.50

Prices & specifications are subject to change.

Our faucet parts counter is one of the largest in the Boston area with thousands of parts in stock!



# Nipples

## Brass Nipples



### Standard Brass

#### Brass Nipples - 1/8"

Part#	Size	Price
3776	1/8" x Close	1.43
3777	1/8" x 1-1/2"	1.61
3778	1/8" x 2"	1.73
3779	1/8" x 2-1/2"	1.96
3780	1/8" x 3"	2.11
3781	1/8" x 3-1/2"	2.28
3782	1/8" x 4"	2.56
3783	1/8" x 4-1/2"	2.90
3784	1/8" x 5"	3.13
3785	1/8" x 5-1/2"	3.38
3786	1/8" x 6"	3.63

#### Brass Nipples - 1/4"

Part#	Size	Price
3787	1/4" x Close	1.67
3788	1/4" x 1-1/2"	1.93
3789	1/4" x 2"	2.18
3790	1/4" x 2-1/2"	2.36
3791	1/4" x 3"	2.77
3792	1/4" x 3-1/2"	3.02
3793	1/4" x 4"	3.54
3794	1/4" x 4-1/2"	3.85
3795	1/4" x 5"	4.19
3796	1/4" x 5-1/2"	4.54
3797	1/4" x 6"	5.11

#### Brass Nipples - 3/8"

Part#	Size	Price
3798	3/8" x Close	1.73
3799	3/8" x 1-1/2"	2.04
3800	3/8" x 2"	2.48
3801	3/8" x 2-1/2"	2.69
3802	3/8" x 3"	3.29
3803	3/8" x 3-1/2"	3.54
3804	3/8" x 4"	4.21
3805	3/8" x 4-1/2"	4.49
3806	3/8" x 5"	4.92
3807	3/8" x 5-1/2"	5.35
3808	3/8" x 6"	5.79

#### Brass Nipples - 1/2"

Part#	Size	Price
3809	1/2" x Close	2.30
3810	1/2" x 1-1/2"	2.66
3811	1/2" x 2"	3.13
3812	1/2" x 2-1/2"	3.72

#### Brass Nipples - 1/2" (Continued)

Part#	Size	Price
3813	1/2" x 3"	4.36
3814	1/2" x 3-1/2"	4.98
3815	1/2" x 4"	5.70
3816	1/2" x 4-1/2"	6.19
3817	1/2" x 5"	6.82
3818	1/2" x 5-1/2"	7.49
3819	1/2" x 6"	8.30
3820	1/2" x 8"	10.78
3821	1/2" x 10"	13.22
3822	1/2" x 12"	15.73

#### Brass Nipples - 3/4"

Part#	Size	Price
3823	3/4" x Close	3.31
3824	3/4" x 1-1/2"	3.53
3825	3/4" x 2"	4.17
3826	3/4" x 2-1/2"	4.84
3827	3/4" x 3"	5.58
3828	3/4" x 3-1/2"	6.26
3829	3/4" x 4"	7.27
3830	3/4" x 4-1/2"	7.91
3831	3/4" x 5"	8.73
3832	3/4" x 5-1/2"	9.54
3833	3/4" x 6"	10.62
3834	3/4" x 8"	14.01
3835	3/4" x 10"	17.10
3836	3/4" x 12"	20.35

#### Brass Nipples - 1"

Part#	Size	Price
3837	1" x Close	4.88
3838	1" x 2"	6.02
3839	1" x 2-1/2"	7.03
3840	1" x 3"	8.09
3841	1" x 3-1/2"	9.36
3842	1" x 4"	10.53
3843	1" x 4-1/2"	11.74
3844	1" x 5"	12.98
3845	1" x 5-1/2"	14.22
3846	1" x 6"	15.51
3847	1" x 8"	20.67
3848	1" x 10"	25.59
3849	1" x 12"	30.51

#### Brass Nipples - 1-1/4"

Part#	Size	Price
3850	1-1/4" x Close	7.36

#### Brass Nipples - 1-1/4" (Continued)

Part#	Size	Price
3851	1-1/4" x 2"	8.41
3852	1-1/4" x 2-1/2"	9.51
3853	1-1/4" x 3"	11.25
3854	1-1/4" x 3-1/2"	13.16
3855	1-1/4" x 4"	14.82
3856	1-1/4" x 4-1/2"	16.41
3857	1-1/4" x 5"	18.09
3858	1-1/4" x 5-1/2"	19.79
3859	1-1/4" x 6"	21.62
3860	1-1/4" x 8"	28.89
3861	1-1/4" x 10"	35.72
3862	1-1/4" x 12"	42.73

#### Brass Nipples - 1-1/2"

Part#	Size	Price
3863	1-1/2" x Close	9.57
3864	1-1/2" x 2"	10.30
3865	1-1/2" x 2-1/2"	12.34
3866	1-1/2" x 3"	14.18
3867	1-1/2" x 3-1/2"	16.28
3868	1-1/2" x 4"	18.47
3869	1-1/2" x 4-1/2"	20.75
3870	1-1/2" x 5"	22.96
3871	1-1/2" x 5-1/2"	25.12
3872	1-1/2" x 6"	27.28
3873	1-1/2" x 8"	36.22
3874	1-1/2" x 10"	44.88
3875	1-1/2" x 12"	53.53

#### Brass Nipples - 2"

Part#	Size	Price
3876	2" x Close	14.57
3877	2" x 2-1/2"	15.74
3878	2" x 3"	18.16
3879	2" x 3-1/2"	20.90
3880	2" x 4"	23.76
3881	2" x 4-1/2"	26.49
3882	2" x 5"	29.37
3883	2" x 5-1/2"	32.22
3884	2" x 6"	35.08
3885	2" x 7"	41.02
3886	2" x 8"	46.78
3887	2" x 10"	57.94
3888	2" x 12"	69.11

#### Brass Nipples - 2-1/2"

Part#	Size	Price
3889	2-1/2" x Close	38.47
3890	2-1/2" x 3"	40.21
3891	2-1/2" x 3-1/2"	45.56
3892	2-1/2" x 4"	50.65
3893	2-1/2" x 4-1/2"	54.33
3894	2-1/2" x 5"	59.77
3895	2-1/2" x 5-1/2"	64.37
3896	2-1/2" x 6"	70.48

#### Brass Nipples - 3"

Part#	Size	Price
3897	3" x Close	52.30
3898	3" x 3"	54.35
3899	3" x 3-1/2"	61.48
3900	3" x 4"	69.25
3901	3" x 4-1/2"	76.12
3902	3" x 5"	83.76
3903	3" x 5-1/2"	91.01
3904	3" x 6"	98.93

#### Brass Nipples - 4"

Part#	Size	Price
3905	4" x Close	78.69
3906	4" x 3-1/2"	89.74
3907	4" x 4"	102.34
3908	4" x 4-1/2"	110.54
3909	4" x 5"	122.10
3910	4" x 5-1/2"	130.20
3911	4" x 6"	143.76





## Nipples

### Chrome-Plated Pipe Nipples

#### CP Pipe Nipples - 3/8"

Part #	Description	Price
7442	3/8" x Close	5.46
7443	3/8" x 1-1/2"	6.47
7444	3/8" x 2"	7.85
7445	3/8" x 2-1/2"	8.51
7446	3/8" x 3"	10.41
7447	3/8" x 3-1/2"	11.23
7448	3/8" x 4"	13.36
7449	3/8" x 4-1/2"	14.23
7450	3/8" x 5"	15.61
7451	3/8" x 5-1/2"	16.96
7452	3/8" x 6"	18.35

#### CP Pipe Nipples - 1/2"

Part #	Description	Price
7457	1/2" x Close	7.29
7458	1/2" x 1-1/2"	8.43
7459	1/2" x 2"	9.90
7460	1/2" x 2-1/2"	11.78
7461	1/2" x 3"	13.83
7462	1/2" x 3-1/2"	15.78
7463	1/2" x 4"	18.08
7464	1/2" x 4-1/2"	19.62
7465	1/2" x 5"	21.62
7466	1/2" x 5-1/2"	23.75
7467	1/2" x 6"	26.33

#### CP Pipe Nipples - 3/4"

Part #	Description	Price
7468	3/4" x Close	15.72
7469	3/4" x 1-1/2"	16.76
7470	3/4" x 2"	19.80
7471	3/4" x 2-1/2"	22.96
7472	3/4" x 3"	26.48
7473	3/4" x 3-1/2"	29.70
7474	3/4" x 4"	34.54
7475	3/4" x 4-1/2"	37.57
7476	3/4" x 5"	41.47
7477	3/4" x 5-1/2"	45.31
7478	3/4" x 6"	50.45

#### CP Pipe Nipples - 1"

Part #	Description	Price
7479	1" x Close	23.18
7480	1" x 2"	28.59
7481	1" x 2-1/2"	33.37
7482	1" x 3"	38.42
7483	1" x 3-1/2"	44.47
7484	1" x 4"	50.03
7485	1" x 4-1/2"	55.79
7486	1" x 5"	61.69
7487	1" x 5-1/2"	67.56
7488	1" x 6"	73.66

## Vendor Managed Inventory Program

Metropolitan Pipe can assist you in setting up your own *stockroom*- complete with barcodes for easy tracking.



Product ID: 454645

Kohler 4330-0 Kingston elongated wall-hung bowl with top spud



Aisle 7 - Shelf B



## Copper Tubing

### Type K Copper - Green

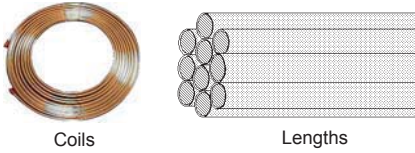

#### Type K Soft Green - 60' Coils

Part#	Size	Price
112	1/4"	1.46
113	3/8"	2.61
114	1/2"	3.04
115	3/4"	5.64
116	1"	7.34
117	1-1/4"	9.34
118	1-1/2"	12.24

#### Type K Soft Green - 100' Coils

Part#	Size	Price
120	3/4"	5.64
121	1"	7.34

#### Type K Hard Green - 20' Lengths

Part#	Size	Price
30	1/4"	1.44
31	3/8"	2.44
32	1/2"	2.36
33	3/4"	5.43
34	1"	7.23
35	1-1/4"	8.80
36	1-1/2"	11.51
37	2"	17.72
38	2-1/2"	26.10
39	3"	36.28
40	4"	59.96

### Type L Copper - Blue

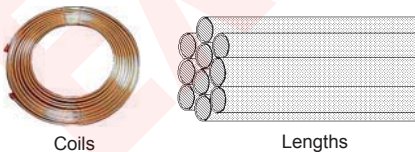

#### Type L Soft Blue - 60' Coils

Part#	Size	Price
122	1/4"	1.22
123	3/8"	1.89
124	1/2"	2.58
125	3/4"	4.12

### Type L Soft Blue - 60' Coils (Continued)

Part#	Size	Price
126	1"	5.77
127	1-1/4"	8.24
33304	1-1/2"	10.55

### Type L Hard Blue - 20' Lengths

Part#	Size	Price
48	1/4"	1.19
49	3/8"	1.81
50	1/2"	2.12
51	3/4"	3.40
52	1"	5.05
53	1-1/4"	7.18
54	1-1/2"	9.27
55	2"	14.64
56	2-1/2"	21.50
57	3"	28.85
58	4"	47.66
59	5"	97.65
60	6"	130.67
45253	8"	247.63

### Type L Hard Blue - 10' Lengths

Part#	Size	Price
41	1/2"	2.12
42	3/4"	3.40
43	1"	5.05
44	1-1/4"	7.18
45	1-1/2"	9.27
46	2"	14.64
33301	2-1/2"	21.50
33302	3"	28.85
33303	4"	47.66

### Type M Copper - Red

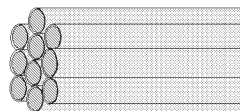

#### Type M Hard Red - 20' Lengths

Part#	Size	Price
68	1/2"	1.51
69	3/4"	2.44
70	1"	3.93
71	1-1/4"	5.77

### Type M Hard Red - 20' Lengths (Continued)

Part#	Size	Price
72	1-1/2"	7.97
73	2"	12.56
74	2-1/2"	18.39
75	3"	24.32
76	4"	42.74

### Type M Hard Red - 10' Lengths

Part#	Size	Price
61	1/2"	1.51
62	3/4"	2.44
63	1"	3.93
64	1-1/4"	5.77
65	1-1/2"	7.97
66	2"	12.56

### Type DWV Copper - Yellow



#### Type DWV Yellow - 20' Lengths

Part#	Size	Price
80	1-1/2"	7.82
81	2"	10.36
82	3"	17.13

#### Type DWV Yellow - 10' Lengths

Part#	Size	Price
77	1-1/2"	7.82
78	2"	10.36

### A/C Refrigeration Copper Tubing - Red



#### Refrigeration ASTM B280 Red - 50' Coils

Part#	Size	Price
104	1/8" OD	29.37
105	3/16" OD	34.34



## Copper Tubing



### Refrigeration ASTM B280 Red - 50' Coils (Continued)

Part#	Size	Price
106	1/4" OD	39.45
107	5/16" OD	52.99
108	3/8" OD	58.69
109	1/2" OD	79.35
110	5/8" OD	107.64
111	3/4" OD	129.48

### ACR/OXY/MED Copper Tubing

- Cleaned & capped
- Purged with dry nitrogen

#### Type ACR/OXY/MED - ASTM B280/ASTM B819 - 10' Lengths

Part#	Size	Price
231527	5/8" OD	2.57
231528	7/8" OD	4.02
231529	1-1/8" OD	5.83
910947	1-3/8" OD	7.83
910948	1-5/8" OD	10.02
910949	2-1/8" OD	15.76

#### Type ACR/OXY/MED - ASTM B280/ASTM B819 - 20' Lengths

Part#	Size	Price
83	3/8" OD	1.39
84	1/2" OD	2.11
85	5/8" OD	2.57
86	3/4" OD	3.62
87	7/8" OD	4.02
88	1-1/8" OD	5.83
89	1-3/8" OD	7.83
90	1-5/8" OD	10.02
91	2-1/8" OD	15.76
92	2-5/8" OD	23.48
93	3-1/8" OD	31.41
94	4-1/8" OD	52.22

### Medical Gas Copper Tubing

- Cleaned & capped
- #### OXY/MED ASTM B819 Type K - 20' Lengths

Part#	Size	Price
95	1/4"	1.60
96	3/8"	2.72
97	1/2"	3.09
98	3/4"	5.64
99	1"	7.46
100	1-1/8"	9.13
101	1-1/4"	12.25
102	2"	18.94

### Copper Fittings



#### Copper Fittings 45° Copper Elbows (C x C)



Part #	Size	Price
6749	1/8"	5.91
6750	1/4"	4.64
6751	3/8"	3.78
6752	1/2"	1.45
6753	5/8"	7.18
6754	3/4"	2.52
6755	1"	6.33
6756	1-1/4"	8.56
6757	1-1/2"	10.31
6758	2"	17.22
6759	2-1/2"	36.69
6760	3"	54.45
6762	4"	116.00
6763	5"	449.32
6765	6"	708.25

### 45° Copper Street Elbows (C x FTG)



Part #	Size	Price
6780	1/4"	6.57
6781	3/8"	5.16
6782	1/2"	1.72
6783	3/4"	2.54
6784	1"	8.36
6785	1-1/4"	10.54
6786	1-1/2"	12.89
6787	2"	20.49
6788	2-1/2"	48.70
6789	3"	65.98
6790	4"	341.54

### 90° Copper Elbows (C x C)



Part #	Size	Price
6710	1/8"	2.35
6711	1/4"	2.48
6712	3/8"	2.35
6713	1/2"	0.79
6714	5/8"	4.77
6715	3/4"	1.77
6716	1"	4.33
6717	1-1/4"	6.53
6718	1-1/2"	10.18
6719	2"	18.56
6720	2-1/2"	37.13
6721	3"	49.62
6723	4"	127.02
45005	5"	531.99
52369	6"	709.30
6728	1/2" x 3/8"	6.57
6731	3/4" x 1/2"	4.56
6733	1" x 1/2"	9.33
6734	1" x 3/4"	8.36
6735	1-1/4" x 1/2"	26.94
6736	1-1/4" x 3/4"	28.66
6737	1-1/4" x 1"	21.28
6738	1-1/2" x 3/4"	38.89

Prices & specifications are subject to change.

Metropolitan Pipe offers FREE DELIVERY in the Greater Boston area.



## Copper Fittings



### Copper Fittings

#### 90° Copper Elbows (C x C) (Continued)

Part #	Size	Price
6739	1-1/2" x 1"	36.01
6740	1-1/2" x 1-1/4"	27.98
115168	2" x 3/4"	61.74
6741	2" x 1"	52.00
6742	2" x 1-1/4"	54.76
6743	2" x 1-1/2"	37.72
6744	2-1/2" x 2"	127.64
6745	3" x 2"	248.51
6722	3-1/2"	237.45

#### 90° Copper Street Elbows (C x FTG)



Part #	Size	Price
6767	1/2"	4.40
6768	1/4"	4.34
6769	3/8"	3.00
6770	1/2"	1.21
6771	5/8"	4.93
6772	3/4"	2.54
6773	1"	6.57
6774	1-1/4"	9.96
6775	1-1/2"	13.05
6776	2"	28.41
6777	2-1/2"	48.49
6778	3"	72.31
6779	4"	166.11

#### 90° Copper Long Turn Elbows (C x C)



Part #	Size	Price
6820	1/2"	4.64
6822	1/4"	3.69
6823	5/16"	3.78
6824	3/8"	4.43
6825	1/2"	3.98

### Copper Fittings

#### 90° Copper Long Turn Elbows (C x C) (Continued)

Part #	Size	Price
6826	5/8"	4.02
6827	3/4"	5.12
6828	1"	7.82
6829	1-1/4"	12.48
6830	1-1/2"	16.76
6831	2"	44.08
6832	2-1/2"	69.80
6833	3"	98.30

#### 90° Copper Cast Male Elbows (C x M)



Part #	Size	Price
6805	3/8"	13.21
6806	1/2"	5.61
6807	3/4"	10.09
6809	1-1/4"	34.46
6810	1-1/2"	46.51
6808	1"	17.79
6811	2"	75.93
6812	3/8" x 1/2"	9.71
6813	1/2" x 3/8"	9.71
6814	1/2" x 3/4"	10.71
6816	3/4" x 1/2"	12.67
6817	3/4" x 1"	25.15
6819	1" x 1/2"	26.63

#### 90° Cast Drop Elbows (C x C)



Part #	Size	Price
6850	1/2"	5.82
6851	3/4"	17.00

### 90° Female Cast Drop Elbows (C x F)



Part #	Size	Price
6852	1/2"	6.26
6853	3/4"	10.99
6854	1/2" x 3/8"	10.15

### 90° Copper Cast Drain Elbows (C x C)



Part #	Size	Price
6846	1/2"	8.64
6847	3/4"	10.57

### 90° Copper Cast Female Elbows (C x F)



Part #	Size	Price
6791	3/8"	8.93
6792	1/2"	4.62
6793	3/4"	7.94
6794	1"	25.11
6795	1-1/4"	42.54
6796	1-1/2"	43.58
6797	2"	77.62
6799	1/2" x 1/4"	8.86
6800	1/2" x 3/8"	7.26
6801	1/2" x 3/4"	12.72
6802	3/4" x 1/2"	12.72
49941	1" x 1/2"	23.98
6803	1" x 3/4"	22.80



## Copper Fittings



### 90° Copper Long Turn Street Elbows (C x FTG)



Part #	Size	Price
6837	1/4"	4.23
6838	3/8"	8.09
6839	1/2"	5.78
6841	3/4"	6.90
6842	1"	11.21
6843	1-1/4"	16.54
6844	1-1/2"	23.00
6845	2"	37.50
48276	2-1/2"	72.31
112550	3"	116.00

### Copper IPS Reamed Adapters (C x IPS)

Part #	Size	Price
6700	1/2"	16.14
133997	3/4"	11.79
139864	1"	19.58

### Copper Female Street Adapters (FTG x F)



Part #	Size	Price
6672	3/8"	7.15
6673	1/2"	5.20
6674	3/4"	6.71
6675	1"	11.99
6676	1-1/4"	19.37
6677	1-1/2"	25.44
6678	2"	33.81
6679	2-1/2"	214.21
6680	3"	205.99
43680	1/2" x 1/4"	8.72
6682	1/2" x 3/8"	7.02
6683	3/4" x 1/2"	15.94
6684	1" x 3/4"	31.14

### Copper Male Street Adapters (FTG x M)



Part #	Size	Price
6686	1/4"	12.24
6687	3/8"	7.01
6688	1/2"	7.25
6689	3/4"	9.33
6690	1"	11.86
6691	1-1/4"	36.66
6692	1-1/2"	44.41
6693	2"	71.78
6694	2-1/2"	184.72
6695	3"	315.52
53423	1/2" x 3/4"	16.76
39128	3/4" x 1/2"	17.48

### Copper Fine Thread Adapters

Part #	Size	Price
6697	1/2" Copper x Female	5.38
6698	1/2" Copper x Male	3.70

### Copper Female Adapters (C x F)



Part #	Size	Price
6588	1/4"	5.33
6589	3/8"	5.46
6590	1/2"	2.61
6591	3/4"	3.58
6592	1"	8.27
6593	1-1/4"	12.10
6594	1-1/2"	18.93
6595	2"	25.71
6596	2-1/2"	93.61
6597	3"	140.53
6598	4"	241.31
6603	3/8" x 1/4"	4.71
6604	3/8" x 1/2"	5.33
6606	1/2" x 1/4"	4.06
6607	1/2" x 3/8"	4.06
6608	1/2" x 3/4"	5.65
53422	1/2" x 1"	19.43
6611	3/4" x 3/8"	8.97

### Copper Fittings Copper Female Adapters (C x F) (Continued)

Part #	Size	Price
6612	3/4" x 1/2"	5.65
6613	3/4" x 1"	12.10
6614	1" x 1/2"	15.14
6615	1" x 3/4"	12.10
6616	1" x 1-1/4"	21.75
57088	1-1/4" x 3/4"	29.34
6617	1-1/4" x 1"	25.58
6618	1-1/4" x 1-1/2"	25.85
6619	1-1/4" x 2"	56.51
48127	1-1/2" x 1"	35.39
6620	1-1/2" x 1-1/4"	28.13
6621	1-1/2" x 2"	48.04
6623	2" x 1-1/2"	41.83

### Copper Male Adapters (C x M)



Part #	Size	Price
6626	1/4"	8.17
6627	3/8"	4.06
6628	1/2"	1.64
6629	3/4"	2.76
6630	1"	7.12
6631	1-1/4"	10.54
6632	1-1/2"	12.10
6633	2"	20.49
6634	2-1/2"	78.46
6635	3"	103.80
6636	4"	148.58
6637	5"	836.99
6638	6"	931.08
6640	1/4" x 1/8"	9.63
6642	1/4" x 1/2"	4.79
6643	3/8" x 1/4"	9.57
6644	3/8" x 1/2"	5.52
6645	1/2" x 1/4"	5.05
6646	1/2" x 3/8"	4.19
6647	1/2" x 3/4"	4.79
6648	1/2" x 1"	10.75
6652	3/4" x 1/2"	4.79
6653	3/4" x 1"	10.54
6654	3/4" x 1-1/4"	20.21

Prices & specifications are subject to change.

Metropolitan Pipe offers Vendor Managed Inventory - never run out of that part again!



## Copper Fittings



### Copper Fittings Copper Male Adapters (C x M) (Continued)

Part #	Size	Price
6655	1" x 1/2"	13.15
6656	1" x 3/4"	10.54
6657	1" x 1-1/4"	15.50
6658	1" x 1-1/2"	29.16
6659	1-1/4" x 3/4"	18.15
6660	1-1/4" x 1"	15.74
6661	1-1/4" x 1-1/2"	24.61
6662	1-1/4" x 2"	53.86
6664	1-1/2" x 1"	29.10
6666	1-1/2" x 1-1/4"	24.50
6665	1-1/2" x 2"	45.93
6667	2" x 1-1/4"	52.63
6668	2" x 1-1/2"	47.36
6669	2" x 2-1/2"	155.93
92234	2-1/2" x 2"	143.19

### Copper Flush Trap Bushings (C x C)



Part #	Size	Price
6542	3/8" x 1/4"	1.36
6544	1/2" x 1/4"	1.86
6545	1/2" x 3/8"	1.64
6549	3/4" x 1/2"	3.04
6552	1" x 1/2"	5.23
6553	1" x 3/4"	4.65
6554	1-1/4" x 1/2"	5.77
6556	1-1/4" x 1"	5.77
190699	1-1/2" x 1"	8.69
6557	1-1/2" x 1-1/4"	7.59
6560	2" x 1-1/2"	21.75

### Copper Fitting x Female Flush Bushings (FTG x F)



Part #	Size	Price
6561	1/2" x 1/8"	4.58

### Copper Fittings Copper Fitting x Female Flush Bushings (FTG x F) (Continued)

Part #	Size	Price
6562	1/2" x 1/4"	4.80
92826	1" x 1/2"	17.72

### Copper Test Caps (C x C)

Part #	Size	Price
7126	1/2"	0.68
7127	3/4"	0.76
7128	1"	1.36
7129	1-1/4"	1.36
7130	1-1/2"	1.37
7131	2"	2.93
7132	3"	6.02

### Copper Caps (C x C)

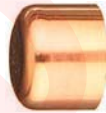

Part #	Size	Price
7105	1/8"	1.16
7106	1/4"	0.73
7107	3/8"	1.15
7108	1/2"	0.58
7109	5/8"	1.37
7110	3/4"	1.07
7111	1"	2.52
7112	1-1/4"	3.39
7113	1-1/2"	4.94
7114	2"	9.11
7115	2-1/2"	29.07
7116	3"	39.83
7117	4"	75.13
7119	6"	1210.63

### Copper Slip Couplings (C x C)



Part #	Size	Price
6484	1/2"	0.79
6485	3/4"	1.64

### Copper Fittings Copper Slip Couplings (C x C) (Continued)

Part #	Size	Price
6486	1"	3.45
6487	1-1/4"	5.20
6488	1-1/2"	7.02
6489	2"	11.86
6490	2-1/2"	15.52
6491	3"	30.36
6492	4"	58.16
41240	6"	274.64

### Copper Cast Jet Couplings (C x C)



Part #	Size	Price
6495	1"	13.86
6494	3/4"	9.33
6493	1/2"	7.88

### Copper Eccentric Couplings (C x C)



Part #	Size	Price
6476	3/4" x 1/2"	14.62
6478	1" x 3/4"	19.69
6480	1-1/4" x 3/4"	29.66

### Copper Couplings (C x C)



Part #	Size	Price
6412	1/8"	0.70
6414	1/4"	0.58
6416	3/8"	0.76
6417	1/2"	0.60
6418	5/8"	1.80
6419	3/4"	1.20
6421	1"	2.38
6422	1-1/4"	4.23
6423	1-1/2"	5.59
6424	2"	9.33

Pipe, Fittings, Hardware

Prices & specifications are subject to change.



## Copper Fittings



### Copper Fittings Copper Couplings (C x C) (Continued)

Part #	Size	Price
6425	2-1/2"	19.80
6426	3"	29.78
6428	4"	62.62
6429	5"	154.15
6431	6"	254.74
6434	1/4" x 1/8"	3.89
6436	3/8" x 1/4"	1.28
6437	1/2" x 1/8"	1.67
6438	1/2" x 1/4"	1.52
6439	1/2" x 3/8"	1.25
6441	5/8" x 3/8"	3.75
6442	5/8" x 1/2"	3.04
6443	3/4" x 1/4"	2.63
6444	3/4" x 3/8"	2.68
6445	3/4" x 1/2"	2.12
6446	3/4" x 5/8"	2.15
6447	1" x 3/8"	4.79
6448	1" x 1/2"	4.64
6449	1" x 3/4"	3.93
6450	1-1/4" x 1/2"	5.73
6451	1-1/4" x 3/4"	5.51
6452	1-1/4" x 1"	5.51
6453	1-1/2" x 1/2"	9.68
6454	1-1/2" x 3/4"	9.12
6455	1-1/2" x 1"	9.12
6456	1-1/2" x 1-1/4"	9.12
6457	2" x 1/2"	15.76
6458	2" x 3/4"	15.15
6459	2" x 1"	14.86
6460	2" x 1-1/4"	14.09
6461	2" x 1-1/2"	14.09
6462	2-1/2" x 1"	36.19
6463	2-1/2" x 1-1/4"	35.96
6464	2-1/2" x 1-1/2"	31.83
6465	2-1/2" x 2"	31.16
6466	3" x 1-1/2"	44.85
6467	3" x 2"	40.15
6468	3" x 2-1/2"	40.99
6469	4" x 2"	91.97
6470	4" x 2-1/2"	95.66
6471	4" x 3"	84.09
6474	6" x 4"	543.45

### Copper Cast Crosses (C x C x C x C)



Part #	Size	Price
7099	1/2"	12.77
7100	3/4"	24.81
7101	1"	42.14
7102	1-1/4"	60.55

### Copper Companion Flanges 125 LB (C x Flange)



Part #	Size	Price
7134	3/4"	53.99
7135	1"	35.48
7136	1-1/4"	36.94
7137	1-1/2"	64.17
7138	2"	92.56
7139	2-1/2"	119.08
7140	3"	123.24
7141	4"	171.94
7142	5"	320.75
7143	6"	336.38

### Copper Suction Line P-Traps (C x C)



Part #	Size	Price
7124	1/2"	23.91
7125	3/4"	26.31

### Copper Fitting Plugs (C x FTG)



Part #	Size	Price
7121	3/4"	9.83

### Copper Fittings Copper Fitting Plugs (C x FTG) (Continued)

Part #	Size	Price
7122	1"	12.72

### Copper Fitting Reducers (C x FTG)



Part #	Size	Price
6500	3/8" x 1/4"	1.73
6501	1/2" x 1/4"	1.56
6502	1/2" x 3/8"	1.41
6507	3/4" x 3/8"	2.78
6508	3/4" x 1/2"	2.12
6509	3/4" x 5/8"	2.15
6510	1" x 3/8"	4.02
6511	1" x 1/2"	4.25
6512	1" x 3/4"	3.27
6513	1-1/4" x 1/2"	6.01
6514	1-1/4" x 3/4"	6.01
6515	1-1/4" x 1"	6.01
6516	1-1/2" x 1/2"	7.83
6517	1-1/2" x 3/4"	7.83
6518	1-1/2" x 1"	7.83
6519	1-1/2" x 1-1/4"	7.83
6520	2" x 1/2"	16.49
6521	2" x 3/4"	15.54
6522	2" x 1"	15.54
6523	2" x 1-1/4"	14.74
6524	2" x 1-1/2"	14.74
6525	2-1/2" x 1"	34.14
6526	2-1/2" x 1-1/4"	30.51
6527	2-1/2" x 1-1/2"	29.96
6528	2-1/2" x 2"	29.35
6529	3" x 1-1/4"	40.25
6530	3" x 1-1/2"	41.17
6531	3" x 2"	36.84
6532	3" x 2-1/2"	37.67
6533	4" x 2"	86.74
6534	4" x 2-1/2"	82.39
6535	4" x 3"	79.23
6536	5" x 4"	459.86
6538	6" x 4"	731.88
48952	6" x 5"	731.88

Prices & specifications are subject to change.

Our faucet parts counter is one of the largest in the Boston area with thousands of parts in stock!



## Copper Fittings



### Copper Tees (C x C x C)



Part #	Size	Price
6862	1/8"	4.93
6864	1/4"	5.20
6866	3/8"	3.98
6867	1/2"	1.35
6869	3/4"	3.24
6868	5/8"	8.64
6870	1"	9.99
6871	1-1/4"	13.65
6872	1-1/2"	21.04
6873	2"	32.80
6874	2-1/2"	66.17
6875	3"	101.00
6876	3-1/2"	400.39
6877	4"	244.42
6878	5"	800.12
6880	6"	1093.47
6882	1/4" x 1/8"	11.50
7036	1/4" x 1/2"	8.82
7038	1/2" x 3/4"	6.21
6884	1/2" x 1/4"	6.90
6935	1/2" x 1/4" x 1/4"	8.97
6885	1/2" x 3/8"	6.90
6937	1/2" x 3/8" x 1/2"	9.49
7039	1/2" x 1"	13.26
6888	3/4" x 1/4"	4.45
6890	3/4" x 1/2"	3.11
6941	3/4" x 1/2" x 3/8"	8.80
6942	3/4" x 1/2" x 1/2"	3.81
6943	3/4" x 1/2" x 3/4"	3.81
7040	3/4" x 1"	10.86
6944	1" x 1/2" x 1/2"	11.91
6945	1" x 1/2" x 3/4"	12.55
6946	1" x 1/2" x 1"	11.91
6947	1" x 3/4" x 3/8"	29.00
6948	1" x 3/4" x 1/2"	11.91
6949	1" x 3/4" x 3/4"	11.91
6950	1" x 3/4" x 1"	11.91
6892	1" x 3/8"	12.27
6893	1" x 1/2"	10.02
6894	1" x 3/4"	10.02
7041	1" x 1-1/4"	22.29
7042	1" x 1-1/2"	31.52

### Copper Fittings

#### Copper Tees (C x C x C) (Continued)

Part #	Size	Price
6953	1-1/4" x 1/2" x 1-1/4"	19.37
6954	1-1/4" x 3/4" x 1/2"	21.16
6955	1-1/4" x 3/4" x 3/4"	18.93
6956	1-1/4" x 3/4" x 1"	20.38
6957	1-1/4" x 3/4" x 1-1/4"	18.93
6958	1-1/4" x 1" x 1/2"	19.37
6959	1-1/4" x 1" x 3/4"	18.93
6960	1-1/4" x 1" x 1"	18.93
6961	1-1/4" x 1" x 1-1/4"	19.37
6895	1-1/4" x 1/2"	14.74
6896	1-1/4" x 3/4"	14.74
6897	1-1/4" x 1"	14.74
7043	1-1/4" x 1-1/2"	31.94
7044	1-1/4" x 2"	65.66
6898	1-1/2" x 1/2"	15.65
6964	1-1/2" x 1/2" x 1-1/2"	32.11
6899	1-1/2" x 3/4"	15.65
6965	1-1/2" x 3/4" x 3/4"	33.34
6966	1-1/2" x 3/4" x 1"	33.34
6967	1-1/2" x 3/4" x 1-1/4"	34.45
6968	1-1/2" x 3/4" x 1-1/2"	31.40
6900	1-1/2" x 1"	15.65
6969	1-1/2" x 1" x 1/2"	33.34
6970	1-1/2" x 1" x 3/4"	32.38
6971	1-1/2" x 1" x 1"	31.40
6972	1-1/2" x 1" x 1-1/4"	33.34
6973	1-1/2" x 1" x 1-1/2"	32.04
6901	1-1/2" x 1-1/4"	15.65
6974	1-1/2" x 1-1/4" x 1/2"	33.34
6975	1-1/2" x 1-1/4" x 3/4"	32.04
6976	1-1/2" x 1-1/4" x 1"	31.40
6977	1-1/2" x 1-1/4" x 1-1/4"	32.04
6978	1-1/2" x 1-1/4" x 1-1/2"	33.34
7045	1-1/2" x 2"	61.12
6902	2" x 1/2"	24.78
6979	2" x 1/2" x 2"	42.65
6903	2" x 3/4"	24.78
6980	2" x 3/4" x 2"	42.65
6904	2" x 1"	25.54
6981	2" x 1" x 1"	42.65
6982	2" x 1" x 2"	42.65
6905	2" x 1-1/4"	28.35
6984	2" x 1-1/4" x 3/4"	45.83
6985	2" x 1-1/4" x 1"	45.83

### Copper Fittings

#### Copper Tees (C x C x C) (Continued)

Part #	Size	Price
6986	2" x 1-1/4" x 1-1/4"	46.25
51572	2" x 1-1/4" x 1-1/2"	45.83
6987	2" x 1-1/4" x 2"	44.35
6906	2" x 1-1/2"	25.54
6988	2" x 1-1/2" x 1/2"	44.05
6989	2" x 1-1/2" x 3/4"	42.65
6990	2" x 1-1/2" x 1"	42.65
6991	2" x 1-1/2" x 1-1/4"	46.25
6992	2" x 1-1/2" x 1-1/2"	41.75
6993	2" x 1-1/2" x 2"	42.65
7046	2" x 2-1/2"	122.02
7047	2" x 3"	230.76
6907	2-1/2" x 1/2"	77.14
6908	2-1/2" x 3/4"	75.50
6994	2-1/2" x 3/4" x 2-1/2"	106.00
6909	2-1/2" x 1"	77.14
6995	2-1/2" x 1" x 2-1/2"	110.02
6910	2-1/2" x 1-1/4"	77.14
6997	2-1/2" x 1-1/4" x 2-1/2"	110.02
6911	2-1/2" x 1-1/2"	77.14
167974	2-1/2" x 1-1/2" x 1-1/4"	105.12
6998	2-1/2" x 1-1/2" x 1-1/2"	133.93
6999	2-1/2" x 1-1/2" x 2"	129.60
7000	2-1/2" x 1-1/2" x 2-1/2"	104.01
6912	2-1/2" x 2"	77.14
7001	2-1/2" x 2" x 1/2"	104.01
7003	2-1/2" x 2" x 1"	104.01
7004	2-1/2" x 2" x 1-1/4"	104.01
7005	2-1/2" x 2" x 1-1/2"	100.02
7006	2-1/2" x 2" x 2"	96.58
7007	2-1/2" x 2" x 2-1/2"	99.82
7048	2-1/2" x 3"	196.73
6913	3" x 1/2"	84.97
6914	3" x 3/4"	84.97
6915	3" x 1"	84.97
6916	3" x 1-1/4"	84.97
6917	3" x 1-1/2"	84.97
6918	3" x 2"	84.97
6919	3" x 2-1/2"	92.94
7008	3" x 3/4" x 3"	151.06
7009	3" x 1" x 3"	155.17
7010	3" x 1-1/4" x 3"	155.17
7011	3" x 1-1/2" x 3"	142.03
7014	3" x 2" x 1-1/2"	204.89





## Copper Fittings



### Copper Fittings

#### Copper Tees (C x C x C) (Continued)

Part #	Size	Price
7015	3" x 2" x 2"	138.69
7016	3" x 2" x 2-1/2"	154.76
7017	3" x 2" x 3"	147.03
7018	3" x 2-1/2" x 1-1/2"	174.16
7019	3" x 2-1/2" x 2"	142.03
7020	3" x 2-1/2" x 2-1/2"	142.03
7021	3" x 2-1/2" x 3"	147.03
6876	3-1/2"	400.39
6920	4" x 3/4"	176.82
6921	4" x 1"	155.99
7022	4" x 1" x 4"	326.00
6922	4" x 1-1/4"	163.35
6923	4" x 1-1/2"	155.99
6924	4" x 2"	164.99
7025	4" x 2" x 4"	326.00
6925	4" x 2-1/2"	188.00
7029	4" x 2-1/2" x 4"	326.00
6926	4" x 3"	173.66
7033	4" x 3" x 3"	314.49
7034	4" x 3" x 4"	326.00
52372	6" x 3"	1093.47
6927	6" x 4"	1093.47

#### Copper Female Cast Tees (C x C x F)



Part #	Size	Price
7049	3/8"	13.09
7050	1/2"	8.98
7051	3/4"	14.52
7052	1"	34.24
7053	1-1/4"	45.41
7054	1-1/2"	61.47
7055	2"	91.36
7056	1/2" x 1/4"	8.42
7057	1/2" x 3/8"	9.08
7058	3/4" x 3/8"	16.83
7059	3/4" x 1/2"	15.20
7060	1" x 1/2"	22.26
7061	1" x 3/4"	23.50
7062	1-1/4" x 1/2"	35.10
7063	1-1/4" x 3/4"	36.81
7064	1-1/2" x 1/2"	53.67

### Copper Fittings

#### Copper Female Cast Tees (C x C x F) (Continued)

Part #	Size	Price
7065	1-1/2" x 3/4"	53.67
7066	1-1/2" x 1"	53.67
7067	2" x 1/2"	87.20
7068	2" x 3/4"	87.20

#### Copper Female Copper Cast Tees (C x F x C)



Part #	Size	Price
7069	1/2"	8.61
7070	3/4"	16.39
7071	1"	52.00
7072	1-1/4"	74.63
7073	1-1/2"	105.48
7075	1/2" x 1/8" x 1/2"	7.83
7079	3/4" x 1/8" x 3/4"	8.42
7081	3/4" x 1/2" x 3/4"	12.93
7082	1" x 1/8" x 1"	15.63
7083	1" x 1/2" x 1"	35.64
7084	1" x 3/4" x 1"	36.01
7085	1-1/4" x 1/2" x 1-1/4"	84.15
7086	1-1/4" x 3/4" x 1-1/4"	84.15
7087	1-1/2" x 1/2" x 1-1/2"	122.79
7088	1-1/2" x 3/4" x 1-1/2"	121.47
7089	2" x 1/2" x 2"	109.94
7090	2" x 3/4" x 2"	104.96

#### Female Cast Copper Tees (F x F x C)



Part #	Size	Price
7091	3/4"	22.53
7092	3/4" x 1/2"	19.08
7094	3/4" x 1/2" x 1/2"	17.61
7093	3/4" x 1/2" x 3/4"	20.34

### Copper Unions (C x C)



Part #	Size	Price
6565	1/4"	14.15
6566	3/8"	17.72
6567	1/2"	9.45
6569	3/4"	11.84
6570	1"	20.37
6571	1-1/4"	35.28
6572	1-1/2"	46.45
6573	2"	75.26
6574	2-1/2"	173.30
6575	3"	448.44

### Copper Cast Female Unions (C x F)



Part #	Size	Price
6576	1/2"	20.82
6577	3/4"	28.37
6578	1"	59.01
115169	1-1/2"	139.29

### Copper Cast Male Unions (C x M)



Part #	Size	Price
6580	1/2"	16.45
6581	3/4"	24.67
6582	1"	60.73
6583	1-1/4"	75.28
6584	1-1/2"	79.11
6585	2"	121.47

Prices & specifications are subject to change.

Our office hours are 7am to 4:30pm and counter hours 6am to 4:30pm Monday through Friday.



## Copper Fittings



### 45° Copper Cast Wyes (C x C x C)



Part #	Size	Price
7095	1/2"	17.24
7096	3/4"	24.78
7097	1"	33.43

### 45° Copper DWV Elbows (C x C)



Part #	Size	Price
7212	1-1/4"	6.99
7213	1-1/2"	5.78
7214	2"	13.29
7215	3"	28.18
7216	4"	120.50

### Copper DWV Fittings

#### 90° Copper DWV Elbows (C x C) (Continued)

Part #	Size	Price
7204	2"	14.83
7205	3"	36.68
7206	4"	175.23
7207	2" x 1-1/2"	31.83

#### 90° Copper Cast DWV Twin Elbows (C x C x C)



Part #	Size	Price
7239	2"	87.31
7240	2" x 1-1/2"	76.41

## DWV Copper Fittings



### Copper DWV Fittings

#### 11-1/4° Copper DWV Elbows (C x C)



Part #	Size	Price
7221	1-1/4"	7.40
7222	1-1/2"	18.52
7223	2"	26.11
7224	3"	53.76

### 45° Copper DWV Street Elbows (C x FTG)



Part #	Size	Price
7231	1-1/4"	10.75
7232	1-1/2"	8.09
7233	2"	16.49
7234	3"	39.65
7235	4"	164.10

#### 90° Copper DWV Street Elbows (C x FTG)



Part #	Size	Price
7226	1-1/4"	13.52
7227	1-1/2"	10.54
7228	2"	20.45
7229	3"	43.65
7230	4"	247.04

### 60° Copper DWV Elbows (C x C)



Part #	Size	Price
7208	1-1/4"	13.57
7209	1-1/2"	12.58
7210	2"	23.61
7211	3"	53.27

#### 22-1/2° Copper DWV Elbows (C x C)



Part #	Size	Price
7217	1-1/4"	14.14
7218	1-1/2"	16.67
7219	2"	21.54
7220	3"	37.63

### 90° Copper DWV Elbows (C x C)



Part #	Size	Price
7202	1-1/4"	7.59
7203	1-1/2"	11.36

### Copper x Female DWV Adapters (C x F)



Part #	Size	Price
7175	1-1/2"	9.96
7176	2"	18.59
7177	3"	96.01
7178	4"	156.60



## Copper DWV Fittings



### Copper x Male DWV Adapters (C x M)



Part #	Size	Price
7179	1-1/4"	10.94
7180	1-1/2"	14.01
7181	2"	15.10
7182	3"	83.76
7183	4"	140.53
7185	1-1/2" x 2"	23.72
7186	2" x 1-1/2"	26.53

### Copper No-Hub DWV Adapters



Part #	Size	Price
7198	2" x 2"	17.57
7199	3" x 3"	41.75
7200	4" x 4"	76.71
7201	1-1/2" x 2"	19.01

### Copper DWV Flush Trap Bushings / Scully (C x M)



Part #	Size	Price
7165	1-1/2"	20.24
7166	2"	22.01

### Copper DWV Hex Trap Bushings



Part #	Size	Price
7167	1-1/2"	18.52
7168	2"	22.23

### Copper DWV Flush Cleanouts (C x FTG)



Part #	Size	Price
7293	1-1/4"	19.04
7294	1-1/2"	23.85
7295	2"	28.60
7296	3"	60.55
7297	4"	113.92

### Copper DWV Slip Couplings (C x C)



Part #	Size	Price
7154	1-1/2"	5.23
7155	2"	7.16
7156	3"	13.05

### Copper DWV Couplings (C x C)



Part #	Size	Price
7144	1-1/4"	3.56
7145	1-1/2"	4.43
7146	2"	6.13
7147	3"	11.86
7148	4"	37.77
7149	2" x 1-1/2"	8.27
7150	3" x 1-1/2"	28.35
7151	3" x 2"	27.05
7152	4" x 2"	63.11
7153	4" x 3"	52.90

### Copper DWV Dandys (C x C)



Part #	Size	Price
7285	1-1/2"	53.31
7286	2"	67.23
7287	3"	174.24

### Copper DWV Manhoffs



Part #	Size	Price
7189	2" x 2"	15.58
7194	3" x 2"	66.84
7190	3" x 3"	53.60
7196	4" x 3"	97.83
7191	4" x 4"	82.55
7192	2" x 1-1/2"	31.52
7193	3" x 1-1/2"	85.42

### Copper DWV P-Traps (C x C)



Part #	Size	Price
7306	1-1/2" Less C/O	60.36
7307	2" Less C/O	93.25
7300	1-1/2" With C/O	67.16
7301	2" With C/O	102.82

### Copper DWV Cleanout Plugs



Part #	Size	Price
7309	1-1/2"	10.09
7310	2"	4.62

Prices & specifications are subject to change.

You can check stock availability, pricing and place orders online at [www.MetPipe.com](http://www.MetPipe.com).



## Copper DWV Fittings



### Copper DWV Reducers (C x FTG)



Part #	Size	Price
7157	2" x 1-1/2"	7.33
7158	3" x 1-1/2"	45.52
7159	3" x 2"	31.89

### Copper DWV Double TYs (C x C)



Part #	Size	Price
7258	1-1/2"	41.74
7259	2"	96.20
7261	2" x 1-1/2"	86.16
7262	3" x 1-1/2"	146.42
7263	3" x 2"	122.66

### Copper DWV TYs (C x C)



Part #	Size	Price
7241	1-1/4"	14.98
7242	1-1/2"	18.66
7243	2"	21.75
7244	3"	78.67
7245	4"	235.39
7246	1-1/2" x 1-1/4"	22.33
7247	2" x 1-1/2"	20.54
7253	2" x 1-1/2" x 1-1/2"	34.72
7254	2" x 1-1/2" x 2"	35.48
7248	3" x 1-1/2"	61.95
7249	3" x 2"	61.95
7250	4" x 1-1/2"	189.34
7252	4" x 3"	196.18

### Copper Cast DWV Double Wyes (C x C)



Part #	Size	Price
7279	1-1/2"	60.98
7280	2"	108.01
7281	3"	173.30
7282	2" x 1-1/2"	87.20

### Copper DWV Wyes (C x C)



Part #	Size	Price
7265	1-1/4"	28.96
7266	1-1/2"	37.07
7267	2"	40.99
7268	3"	99.04
7269	4"	235.39
7270	1-1/2" x 1-1/4"	50.91
7271	2" x 1-1/2"	43.61
7277	2" x 1-1/2" x 1-1/2"	53.67
7278	2" x 1-1/2" x 2"	59.64
7272	3" x 1-1/2"	90.11
7273	3" x 2"	90.11
7275	4" x 2"	166.77
7276	4" x 3"	166.77



### Washed & Bagged Copper Fittings

#### Copper Washed & Bagged 90° Elbows (C x C)

- Washed & bagged individually for oxygen service



Part #	Size	Price
860018	1/4"	3.82
859752	3/8"	7.60

### Washed & Bagged Copper Fittings

#### Copper Washed & Bagged 90° Elbows (C x C) (Continued)

Part #	Size	Price
234973	1/2"	2.54
859753	5/8"	7.37
186377	3/4"	5.70
186376	1"	13.99
189877	1-1/4"	21.13
186403	1-1/2"	32.94
220901	2"	60.04
220893	2-1/2"	120.13
220889	3"	160.56
231938	2" x 1-1/4"	Call
897353	2" x 1-1/2"	Call

#### Copper Washed & Bagged Street 90° Elbows (C x FTG)

- Washed & bagged individually for oxygen service



Part #	Size	Price
859759	3/8"	9.68
234983	1/2"	3.89
859760	5/8"	7.62
234984	3/4"	8.23
234985	1"	21.26
231897	1-1/4"	32.22
234987	1-1/2"	42.20
220904	2"	91.92
234989	2-1/2"	156.89
234990	3"	233.96

#### Copper Washed & Bagged Couplings (C x C)

- Washed & bagged individually for oxygen service



Part #	Size	Price
860019	1/4"	0.99
195134	3/8"	2.46
176225	1/2"	1.93
859745	5/8"	2.89
186381	3/4"	3.87
186379	1"	7.70

Prices & specifications are subject to change.



## Washed Copper Fittings



### Washed & Bagged Copper Fittings

#### Copper Washed & Bagged Couplings (C x C) (Continued)

Part #	Size	Price
189878	1-1/4"	13.67
186405	1-1/2"	18.08
231940	2"	30.19
220895	2-1/2"	64.07
220890	3"	96.34
215802	1/2" x 1/4"	4.91
859793	1/2" x 3/8"	4.02
859794	3/4" x 1/4"	4.28
234950	3/4" x 3/8"	8.67
235930	3/4" x 1/2"	6.85
859746	3/4" x 5/8"	3.50
220934	1" x 3/8"	15.49
859747	1" x 1/2"	15.01
234952	1" x 3/4"	12.69
866632	1-1/4" x 1/2"	18.52
866631	1-1/4" x 3/4"	17.81
234953	1-1/4" x 1"	17.81
866630	1-1/2" x 1/2"	31.31
866629	1-1/2" x 3/4"	29.50
860100	1-1/2" x 1"	29.50
866628	1-1/2" x 1-1/4"	29.50
876380	2" x 1/2"	51.00
234954	2" x 3/4"	49.01
220907	2" x 1"	48.08
817267	2" x 1-1/4"	45.59
861156	2" x 1-1/2"	45.59
220898	2-1/2" x 1"	58.80
880503	2-1/2" x 1-1/2"	Call
879807	2-1/2" x 2"	100.83

#### Copper Washed & Bagged Slip Couplings (C x C)

- Washed & bagged individually for oxygen service



Part #	Size	Price
863268	1/2"	2.54
822008	3/4"	5.28
859817	1"	11.14
817283	1-1/4"	16.80
862535	1-1/2"	22.71
220903	2"	38.38

### Washed & Bagged Copper Fittings

#### Copper Washed & Bagged Slip Couplings (C x C) (Continued)

Part #	Size	Price
903302	3"	Call

#### Copper Washed & Bagged Copper Female Adapters (C x F)

- Washed & bagged individually for oxygen service



Part #	Size	Price
217017	3/8"	17.66
212677	1/2"	8.43
221327	3/4"	11.58
234960	1"	26.75
231900	1-1/4"	39.16
866618	1-1/2"	61.24
866619	2"	83.18
903596	2-1/2"	302.91
903594	3"	Call
879808	1/2" x 1/4"	13.12
863283	1/2" x 3/8"	13.12
863279	3/4" x 1/2"	18.28
863280	1" x 1/2"	48.97
863675	1-1/4" x 1"	82.76

#### Copper Washed & Bagged Copper Male Adapters (C x M)

- Washed & bagged individually for oxygen service



Part #	Size	Price
859739	3/8"	13.12
212676	1/2"	5.31
220930	3/4"	8.91
220926	1"	23.02
866616	1-1/4"	34.10
220915	1-1/2"	39.16
866617	2"	66.28
880132	2-1/2"	Call
882285	1/2" x 1/4"	16.33
797148	1" x 3/4"	17.12

### Copper Washed & Bagged 45° Elbows (C x C)

- Washed & bagged individually for oxygen service



Part #	Size	Price
195132	3/8"	12.22
859791	1/2"	4.67
859748	5/8"	11.12
220929	3/4"	8.15
220924	1"	20.47
231896	1-1/4"	27.70
220913	1-1/2"	33.36
220902	2"	55.70
220894	2-1/2"	118.71
220884	3"	176.18

### Copper Washed & Bagged Street 45° Elbows (C x FTG)

- Washed & bagged individually for oxygen service



Part #	Size	Price
859750	3/8"	16.68
235000	1/2"	5.57
859751	5/8"	16.82
220931	3/4"	8.23
859618	1"	27.04
231898	1-1/4"	34.10
220916	1-1/2"	41.69
220905	2"	66.28
220896	2-1/2"	157.57
220891	3"	213.49

### Copper Washed & Bagged Tees (C x C x C)

- Washed & bagged individually for oxygen service



Part #	Size	Price
859768	3/8"	12.86
176226	1/2"	4.34
859769	5/8"	14.02
186388	3/4"	10.46
186383	1"	32.31
220918	1-1/4"	44.15
186404	1-1/2"	68.07

Prices & specifications are subject to change.

We offer a variety of GREEN products such as flush valves, faucets, showerheads & more!



## Washed Copper Fittings



### Washed & Bagged Copper Fittings

#### Copper Washed & Bagged Tees (C x C x C) (Continued)

Part #	Size	Price
235013	2"	106.12
235014	2-1/2"	214.12
235015	3"	326.79
859772	1/2" x 3/8"	22.33
859773	1/2" x 3/8" x 3/8"	15.68
859771	1/2" x 3/8" x 1/2"	15.41
858084	1/2" x 3/4"	10.08
859774	3/4" x 3/8"	Call
859776	3/4" x 3/8" x 3/4"	11.99
186390	3/4" x 1/2"	10.05
859775	3/4" x 1/2" x 3/8"	10.42
186392	3/4" x 1/2" x 1/2"	12.33
186394	3/4" x 1/2" x 3/4"	12.33
885441	3/4" x 1"	17.65
855723	1" x 3/8"	39.70
216586	1" x 1/2"	32.42
817284	1" x 1/2" x 1/2"	38.54
879264	1" x 1/2" x 3/4"	40.59
859778	1" x 1/2" x 1"	38.54
186385	1" x 3/4"	32.42
216587	1" x 3/4" x 1/2"	38.54
235017	1" x 3/4" x 3/4"	38.54
859777	1" x 3/4" x 1"	38.54
216588	1" x 1-1/4"	36.20
879257	1" x 1-1/2"	51.21
220919	1-1/4" x 1/2"	47.70
231902	1-1/4" x 3/4"	47.70
817270	1-1/4" x 3/4" x 3/4"	61.24
220920	1-1/4" x 3/4" x 1-1/4"	61.24
231901	1-1/4" x 1"	47.70
879234	1-1/4" x 1" x 1/2"	31.47
879267	1-1/4" x 1" x 3/4"	61.24
220921	1-1/4" x 1" x 1"	61.24
879263	1-1/4" x 1" x 1-1/4"	62.68
865299	1-1/4" x 1-1/2"	51.88
817282	1-1/2" x 1/2"	50.65
881587	1-1/2" x 1/2" x 1-1/2"	103.88
186406	1-1/2" x 3/4"	50.65
817272	1-1/2" x 3/4" x 1-1/4"	55.96
817268	1-1/2" x 3/4" x 1-1/2"	101.60
855736	1-1/2" x 1"	50.65
879258	1-1/2" x 1" x 3/4"	Call

### Washed & Bagged Copper Fittings

#### Copper Washed & Bagged Tees (C x C x C) (Continued)

Part #	Size	Price
859796	1-1/2" x 1" x 1"	101.60
880991	1-1/2" x 1" x 1-1/2"	103.67
817269	1-1/2" x 1-1/4"	50.65
885517	1-1/2" x 1-1/4" x 3/4"	52.05
862536	1-1/2" x 1-1/4" x 1"	51.00
879253	1-1/2" x 1-1/4" x 1-1/4"	103.67
879252	1-1/2" x 1-1/4" x 1-1/2"	Call
220910	2" x 1/2"	80.16
885440	2" x 1/2" x 2"	69.29
220908	2" x 3/4"	80.16
879255	2" x 3/4" x 2"	137.98
855735	2" x 1"	82.63
883152	2" x 1" x 1"	137.98
881585	2" x 1" x 2"	137.98
231936	2" x 1-1/4"	91.74
879262	2" x 1-1/4" x 3/4"	74.47
220911	2" x 1-1/4" x 1-1/4"	75.15
220909	2" x 1-1/2"	82.63
879070	2" x 1-1/2" x 1-1/2"	135.08
221321	2-1/2" x 1/2"	249.60
235019	2-1/2" x 3/4"	244.29
220900	2-1/2" x 1"	249.60
220897	2-1/2" x 1" x 2-1/2"	178.75
235053	2-1/2" x 1-1/4" x 2-1/2"	178.75
877347	2-1/2" x 1-1/2" x 2"	195.46
879067	2-1/2" x 2"	249.60
879069	2-1/2" x 2" x 2"	156.92
221320	3" x 1/2"	274.94
883169	3" x 3/4" x 3"	245.43
882284	3" x 1"	274.94
220892	3" x 1" x 3"	252.10
235020	3" x 1-1/4"	274.94
881583	3" x 1-1/4" x 3"	252.10
880131	3" x 1-1/2"	274.94
881582	3" x 1-1/2" x 3"	230.77
879071	3" x 2"	274.94
879076	3" x 2" x 2"	448.78
879073	3" x 2" x 3"	238.88

### Copper Washed & Bagged Caps (C x Cap)

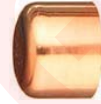

- Washed & bagged individually for oxygen service

Part #	Size	Price
859740	3/8"	3.71
235026	1/2"	1.85
859741	5/8"	2.23
235027	3/4"	3.44
235028	1"	8.15
235029	1-1/4"	10.97
235030	1-1/2"	15.97
235031	2"	29.45
235032	2-1/2"	94.04
235033	3"	128.89

### Copper Washed & Bagged Copper Fitting Reducers (C x FTG)



- Washed & bagged individually for oxygen service

Part #	Size	Price
859761	1/2" x 3/8"	4.54
859763	5/8" x 3/8"	5.54
859762	5/8" x 1/2"	5.48
859765	3/4" x 3/8"	8.99
186397	3/4" x 1/2"	6.85
859764	3/4" x 5/8"	3.50
859766	1" x 3/8"	13.00
186401	1" x 1/2"	13.75
186396	1" x 3/4"	10.56
866627	1-1/4" x 1/2"	19.43
866626	1-1/4" x 3/4"	19.43
234966	1-1/4" x 1"	19.43
866625	1-1/2" x 1/2"	25.33
866624	1-1/2" x 3/4"	25.33
866623	1-1/2" x 1"	25.33
866622	1-1/2" x 1-1/4"	25.33
235291	2" x 1/2"	53.36
861157	2" x 3/4"	50.26
220937	2" x 1"	50.26
866621	2" x 1-1/4"	47.70
866620	2" x 1-1/2"	47.70
235052	2-1/2" x 1"	110.46
877349	2-1/2" x 1-1/2"	96.93
877348	2-1/2" x 2"	94.95
234968	3" x 1-1/4"	130.24

Prices & specifications are subject to change.



## Washed Copper Fittings



### Washed & Bagged Copper Fittings

#### Copper Washed & Bagged Copper Fitting Reducers (C x FTG) (Continued)

Part #	Size	Price
235290	3" x 1-1/2"	133.22
234969	3" x 2"	119.20

#### Copper Washed & Bagged Copper Female Fitting Adapters (C x FTG)

- Washed & bagged individually for oxygen service



Part #	Size	Price
863281	1/2"	16.81
879058	3/4"	21.71
879256	1"	38.78

#### Copper Washed & Bagged Copper Male Fitting Adapters (C x FTG)

- Washed & bagged individually for oxygen service



Part #	Size	Price
887566	1/2"	11.79
879066	3/4"	30.19
885519	1"	38.38

## Custom Pipe Labels

WHILE YOU WAIT!

See page 362 for more details.





## Fittings

**TECTITE™**

### TecTite™ Fittings

#### 200 TecTite™ Couplings with Stop (C x C)



Part #	Mfg #	Size	Price
884548	88005	1/2"	9.62
884549	88010	3/4"	11.00
884550	88014	1"	23.66

#### 201-R TecTite™ Reducer Couplings (C x C)



Part #	Mfg #	Size	Price
884551	88075	3/4" x 1/2"	11.23
884552	88078	1" x 3/4"	28.72

#### 203 TecTite™ Female Adapters (C x F)



Part #	Mfg #	Size	Price
884562	88035	1/2"	8.02
884563	88040	3/4"	9.14
884564	88044	1"	18.48

#### 204 TecTite™ Male Adapters (C x M)



Part #	Mfg #	Size	Price
884565	88025	1/2"	7.75
884566	88030	3/4"	8.74
884567	88034	1"	19.20

#### 207 TecTite™ 90° Elbows (C x C)



Part #	Mfg #	Size	Price
884568	88015	1/2"	9.96
884569	88020	3/4"	12.43
884570	88024	1"	25.43
884571	88018	3/4" x 1/2"	13.23

#### 2707-3-5 TecTite™ 90° Drop Ear Elbow (C x F)



Part #	Mfg #	Size	Price
884572	88055	1/2"	10.39

### 211 TecTite™ Tees



Part #	Mfg #	Size	Price
884573	88060	1/2"	13.75
884574	88065	3/4"	17.28
884575	88068	1"	30.79
884576	88082	3/4" x 1/2" x 1/2"	17.43
884577	88076	3/4" x 1/2" x 3/4"	18.25
884578	88070	3/4" x 3/4" x 1/2"	17.45
884579	88074	1" x 1" x 3/4"	31.43

### 217 TecTite™ Tube Caps



Part #	Mfg #	Size	Price
884580	88045	1/2"	10.04
884581	88050	3/4"	10.30
884582	88054	1"	23.60

### Removal Tools



Part #	Mfg #	Size	Price
884583	65630	1/2"	2.49
884585	65625	3/4"	2.49
884586	65627	1"	2.80





## Press Fittings



### ProPress® Bronze Fittings

- Green spot - EPDM seals
- Smart Connect™ feature
- Copper and Bronze Press Fittings
- Smart Connect system offers a quick, flameless, environmentally friendly way to join standard K, L, or M copper tubing, as well as to identify unpressed fittings. No flux, solder, or gas required.
- UL and CSA Certified; meet IAPMO, NSF/ANSI 61, ABS, NFPA 13, 13D, 13R and ASTM Standards.
- Max. pressure: 200 psi; tested to 600 psi
- Temp. range: 0° to 250°F

#### Bronze Female Adapters (C x FNPT)

- ProPress with shiny black EPDM seal
- Zero lead



Part#	Mfg#	Size	Price
225361	77892	1/2"	2.90
225362	77907	3/4"	4.71
225363	77917	1"	8.68
225364	77932	1-1/4"	19.58
225365	77947	1-1/2"	28.46
225366	77952	2"	48.30
781287	77887	1/2" x 3/8"	3.06
781289	77897	1/2" x 3/4"	5.93
781290	77902	3/4" x 1/2"	4.34
781292	77912	1" x 3/4"	15.32
781294	77922	1" x 1-1/4"	16.40
781295	77927	1-1/4" x 1"	19.79
781297	77937	1-1/4" x 1-1/2"	26.72
781298	77942	1-1/2" x 1-1/4"	27.88

#### Bronze Male Adapters (C x MNPT)

- ProPress with shiny black EPDM seal
- Zero lead



Part#	Mfg#	Size	Price
781274	77817	1/2"	2.41
225394	77832	3/4"	4.34
225395	77842	1"	7.96
225396	77857	1-1/4"	17.41
225397	77872	1-1/2"	24.41
225398	77877	2"	47.00
781273	77812	1/2" x 3/8"	3.63
781275	77822	1/2" x 3/4"	4.71
781276	77827	3/4" x 1/2"	4.93
781278	77837	1" x 3/4"	12.65
781280	77847	1" x 1-1/4"	15.75

Prices & specifications are subject to change.

Metropolitan Pipe offers FREE DELIVERY in the Greater Boston area.

### ProPress® Bronze Fittings (Continued)

#### Bronze Male Adapters (C x MNPT)

Part#	Mfg#	Size	Price
781281	77852	1-1/4" x 1"	18.13
781283	77862	1-1/4" x 1-1/2"	19.36
781284	77867	1-1/2" x 1-1/4"	24.34

#### Bronze Adapter Flanges (C x Flange)

- ProPress with shiny black EPDM seal
- Zero lead



Part#	Mfg#	Size	Price
235578	93407	1-1/2"	382.92
236170	93412	2"	59.62

#### Bronze Female Drop 90° Elbow (C x FNPT)

- ProPress with shiny black EPDM seal
- With wall plate
- Zero lead



Part#	Mfg#	Size	Price
781251	77697	1/2"	9.99
781252	77702	3/4"	19.65

#### Bronze Female 90° Elbow (C x FNPT)

- ProPress with shiny black EPDM seal
- Zero lead



Part#	Mfg#	Size	Price
781218	77532	1/2"	6.73
781220	77542	3/4"	10.70
781222	77552	1"	18.85
781223	77557	1-1/4"	27.71
781224	77562	1-1/2"	35.52
781225	77567	2"	56.40
781219	77537	1/2" x 3/4"	15.46
781221	77547	3/4" x 1/2"	14.70

#### Bronze Male 90° Elbow (C x MNPT)

- ProPress with shiny black EPDM seal
- Zero lead



Part#	Mfg#	Size	Price
781210	77492	1/2"	9.20
781213	77507	3/4"	14.70



## Press Fittings

### ProPress® Bronze Fittings (Continued)

#### Bronze Male 90° Elbow (C x MNPT)

Part#	Mfg#	Size	Price
781214	77512	1"	22.14
781215	77517	1-1/4"	30.14
781216	77522	1-1/2"	41.20
781217	77527	2"	58.21
781211	77497	1/2" x 3/4"	12.57
781212	77502	3/4" x 1/2"	12.38

#### Bronze Tees (C x C x FNPT)

- ProPress with shiny black EPDM seal
- Zero lead



Part#	Mfg#	Size	Price
781228	77582	1/2" x 1/2"	10.49
781229	77587	3/4" x 1/2"	14.24
781230	77592	1" x 1/2"	17.85
781231	77597	1-1/4" x 1/2"	25.57
781360	78342	1-1/2" x 1/2"	30.91
781232	77602	2" x 1/2"	36.90
780270	14558	2" x 3/4"	36.32

#### Bronze Unions (C x C)

- ProPress with shiny black EPDM seal
- Zero lead



Part#	Mfg#	Size	Price
781245	77667	1/2"	15.32
225356	77672	3/4"	20.08
225357	77677	1"	32.06
225358	77682	1-1/4"	45.78
225359	77687	1-1/2"	62.16
225360	77692	2"	101.49

#### Bronze Unions (C x FNPT)

- ProPress with shiny black EPDM seal
- Zero lead



Part#	Mfg#	Size	Price
781261	77752	1/2"	12.30
225654	77757	3/4"	15.75
781263	77762	1"	26.15
781264	77767	1-1/4"	33.07
781265	77772	1-1/2"	51.99
781266	77777	2"	68.86

### Bronze Unions (C x MNPT)

- ProPress with shiny black EPDM seal
- Zero lead



Part#	Mfg#	Size	Price
781267	77782	1/2"	13.36
781268	77787	3/4"	18.50
781269	77792	1"	26.57
781270	77797	1-1/4"	40.01
781271	77802	1-1/2"	55.80
781272	77807	2"	72.98

### Bronze Female Adapters (FTG x FNPT)

- ProPress with shiny black EPDM seal
- Zero lead



Part#	Mfg#	Size	Price
781311	78007	1/2"	9.12
781314	78022	3/4"	13.44
781315	78027	1"	20.58
781316	78032	1-1/4"	35.88
781317	78037	1-1/2"	40.01
781318	78042	2"	67.78
781310	78002	1/2" x 3/8"	9.33
781312	78012	1/2" x 3/4"	9.99
781313	78017	3/4" x 1/2"	11.56

### Bronze Male Adapters (FTG x MNPT)

- ProPress with shiny black EPDM seal
- Zero lead



Part#	Mfg#	Size	Price
781302	77962	1/2"	8.17
781305	77977	3/4"	13.66
781306	77982	1"	20.08
781307	77987	1-1/4"	27.17
781308	77992	1-1/2"	40.50
236169	77997	2"	59.62
781301	77957	1/2" x 3/8"	8.75
781303	77967	1/2" x 3/4"	13.30
781304	77972	3/4" x 1/2"	13.44



## Press Fittings



### ProPress XL-C™ Bronze Fittings

- Green spot - EPDM seals
- Smart Connect™ feature
- Press Wrot Copper XL-C Press Fittings
- Offers a quick, flameless, environmentally friendly way to join K, L, or M copper tubing, without flux, solder, or gas. Must be installed with ProPress XL-C rings;
- Max. pressure: 200 psi; tested to 600 psi
- Temp. range: 0° to 250°F

#### Bronze XL-C Male Adapters (C x MNPT)

- ProPress with shiny black EPDM seal
- Zero lead



Part#	Mfg#	Size	Price
889837	20823	2-1/2"	116.44
889838	20828	3"	146.49
889839	20838	4"	169.57

#### Bronze XL-C Couplings - No Stop (C x C)

- ProPress with shiny black EPDM seal
- Zero lead



Part#	Mfg#	Size	Price
889847	20743	2-1/2"	57.69
889850	20748	3"	74.49
889851	20753	4"	102.40

#### Bronze XL-C Couplings with Stop (C x C)

- ProPress with shiny black EPDM seal
- Zero lead



Part#	Mfg#	Size	Price
889845	20728	2-1/2"	58.00
889846	20733	3"	73.86
889844	20738	4"	102.55

#### Bronze XL-C 90° Elbows (C x C)

- Close rough
- ProPress with shiny black EPDM seal
- Zero lead



Part#	Mfg#	Size	Price
889854	20623	2-1/2"	116.44
889856	20628	3"	146.49
889857	20633	4"	181.23

#### Bronze XL-C Street 90° Elbows (FTG x C)

- ProPress with shiny black EPDM seal
- Close rough
- Zero lead



Part#	Mfg#	Size	Price
889861	20638	2-1/2"	121.08
889860	20643	3"	140.79
889858	20648	4"	179.30

#### Bronze XL-C 45° Elbows (C x C)

- ProPress with shiny black EPDM seal
- Zero lead



Part#	Mfg#	Size	Price
889863	20653	2-1/2"	76.92
889864	20658	3"	109.89
889865	20663	4"	152.60

#### Bronze XL-C Street 45° Elbows (FTG x C)

- ProPress with shiny black EPDM seal
- Zero lead



Part#	Mfg#	Size	Price
889866	20668	2-1/2"	88.80
889868	20673	3"	128.47
889869	20678	4"	162.30

#### Bronze XL-C Reducers (FTG x C)

- ProPress with shiny black EPDM seal
- Zero lead



Part#	Mfg#	Size	Price
889871	20758	2-1/2" x 2"	68.52
889874	20763	3" x 2"	84.83
889875	20768	3" x 2-1/2"	87.38
889876	20773	4" x 2"	97.64
889877	20778	4" x 2-1/2"	106.67
889878	20783	4" x 3"	112.74

#### Bronze XL-C Tees (C x C x C)

- ProPress with shiny black EPDM seal
- Zero lead



Part#	Mfg#	Size	Price
889879	20683	2-1/2"	143.85
889891	20693	3"	179.80
889904	20708	4"	252.29
889889	20688	2-1/2" x 2"	168.99
889901	20698	3" x 2"	206.86

Prices & specifications are subject to change.

Metropolitan Pipe offers Vendor Managed Inventory - never run out of that part again!



# Press Fittings

## ProPress XL-C™ Bronze Fittings (Continued)

### Bronze XL-C Tees (C x C x C)

Part#	Mfg#	Size	Price
889903	20703	3" x 2-1/2"	215.77
889906	20713	4" x 2"	228.36
889907	20718	4" x 2-1/2"	235.35
889909	20723	4" x 3"	257.99

## ProPress Copper Fittings

- Green spot - EPDM seals
- Smart Connect™ feature
- Copper and Bronze Press Fittings
- Smart Connect system offers a quick, flameless, environmentally friendly way to join standard K, L, or M copper tubing, as well as to identify unpressed fittings. No flux, solder, or gas required.
- UL and CSA Certified; meet IAPMO, NSF/ANSI 61, ABS, NFPA 13, 13D, 13R and ASTM Standards.
- Max. pressure: 200 psi; tested to 600 psi
- Temp. range: 0° to 250°F

### Copper Couplings with Stop (C x C)

- ProPress with shiny black EPDM seal
- Zero lead



Part#	Mfg#	Size	Price
225379	78047	1/2"	1.92
225380	78052	3/4"	2.91
225381	78057	1"	5.86
225389	78062	1-1/4"	7.27
225390	78067	1-1/2"	13.54
225391	78072	2"	17.28

### Copper Couplings - No Stop (C x C)

- ProPress with shiny black EPDM seal
- Zero lead



Part#	Mfg#	Size	Price
781342	78172	1/2"	4.60
225711	78177	3/4"	6.29
781344	78182	1"	7.70
781345	78187	1-1/4"	11.72
781346	78192	1-1/2"	18.05
781347	78197	2"	21.01

## Copper Cross-Overs (C x C)

- ProPress with shiny black EPDM seal
- Zero lead



Part#	Mfg#	Size	Price
781259	77742	1/2"	11.65
781260	77747	3/4"	14.48

## Copper Cross-Overs (FTG x C)

- ProPress with shiny black EPDM seal
- Zero lead



Part#	Mfg#	Size	Price
781335	78137	1/2"	4.44
781336	78142	3/4"	8.57

## Copper 90° Elbows (C x C)

- ProPress with shiny black EPDM seal
- Zero lead



Part#	Mfg#	Size	Price
225350	77317	1/2"	2.14
225351	77322	3/4"	3.60
225352	77327	1"	7.21
225353	77332	1-1/4"	14.52
225354	77337	1-1/2"	27.48
225355	77342	2"	38.19

## Copper Street 90° Elbows (FTG x C)

- ProPress with shiny black EPDM seal
- Close rough
- Zero lead



Part#	Mfg#	Size	Price
781181	77347	1/2"	2.14
781182	77352	3/4"	3.60
781183	77357	1"	8.26
781184	77362	1-1/4"	14.67
781185	77367	1-1/2"	27.98
781186	77372	2"	38.47

## Copper 45° Elbows (C x C)

- ProPress with shiny black EPDM seal
- Zero lead



Part#	Mfg#	Size	Price
781233	77607	1/2"	2.48
225345	77612	3/4"	3.05

Pipe, Fittings, Hardware

Prices & specifications are subject to change.



## Press Fittings

### ProPress Copper Fittings (Continued) Copper 45° Elbows (C x C)

Part#	Mfg#	Size	Price
225346	77617	1"	9.74
225347	77622	1-1/4"	13.96
225348	77627	1-1/2"	22.62
225349	77632	2"	31.65

### Copper Street 45° Elbows (FTG x C)

- ProPress with shiny black EPDM seal
- Zero lead



Part#	Mfg#	Size	Price
781239	77637	1/2"	1.92
781240	77642	3/4"	2.84
781241	77647	1"	9.32
781242	77652	1-1/4"	13.46
781243	77657	1-1/2"	20.58
781244	77662	2"	30.51

### Copper Reducers (C x C)

- ProPress with shiny black EPDM seal
- Zero lead



Part#	Mfg#	Size	Price
781337	78147	3/4" x 1/2"	8.69
781338	78152	1" x 3/4"	9.96
225709	78157	1-1/4" x 1"	14.46
781340	78162	1-1/2" x 1-1/4"	21.28
781341	78167	2" x 1-1/2"	23.96

### Copper Reducers (FTG x C)

- ProPress with shiny black EPDM seal
- Zero lead



Part#	Mfg#	Size	Price
781325	78077	3/4" x 1/2"	2.14
225374	78082	1" x 1/2"	5.45
225710	78087	1" x 3/4"	5.66
781328	78092	1-1/4" x 3/4"	6.71
781329	78097	1-1/4" x 1"	7.55
780267	14543	1-1/2" x 3/4"	11.21
236511	78102	1-1/2" x 1"	11.08
781331	78107	1-1/2" x 1-1/4"	11.15
780365	15583	2" x 3/4"	23.18
228038	78112	2" x 1"	12.56
781333	78117	2" x 1-1/4"	15.37

### ProPress Copper Fittings (Continued) Copper Reducers (FTG x C)

Part#	Mfg#	Size	Price
236510	78122	2" x 1-1/2"	14.95

### Copper Tees (C x C x C)

- ProPress with shiny black EPDM seal
- Zero lead



Part#	Mfg#	Size	Price
225369	77377	1/2"	3.26
225370	77387	3/4"	5.72
225371	77412	1"	10.30
225708	77442	1-1/4"	17.42
225372	77457	1-1/2"	33.82
225373	77477	2"	41.78
781188	77382	1/2" x 3/4"	10.87
781190	77392	3/4" x 1/2" x 1/2"	8.82
225367	77397	3/4" x 1/2" x 3/4"	9.17
225399	77402	3/4" x 1/2"	4.81
781193	77407	3/4" x 1"	17.28
225368	94767	1" x 1/2" x 1"	16.56
781195	77417	1" x 3/4" x 1/2"	17.49
233598	77422	1" x 3/4" x 3/4"	15.66
233591	77427	1" x 3/4" x 1"	17.69
781198	77432	1" x 1/2"	11.78
225400	77437	1" x 3/4"	11.72
780272	14568	1-1/4" x 1" x 1"	18.75
225402	77452	1-1/4" x 3/4"	15.93
781201	77447	1-1/4" x 1"	16.56
781612	94757	1-1/4" x 1/2"	14.60
780345	15483	1-1/2" x 1-1/4" x 1-1/4"	31.49
225405	77462	1-1/2" x 3/4"	30.03
233599	77467	1-1/2" x 1"	30.58
225406	77472	1-1/2" x 1-1/4"	31.65
225409	77487	2" x 1-1/4"	50.52
225659	77482	2" x 1-1/2"	37.98
225407	94777	2" x 3/4"	48.89
225408	94772	2" x 1"	50.52

Prices & specifications are subject to change.

Our faucet parts counter is one of the largest in the Boston area with thousands of parts in stock!



## Press Fittings



### ProPress Stainless Steel Fittings

#### Stainless Steel 90° Elbows (P x P)

- Smart Connect Feature
- Stainless Steel 304



Part#	Mfg#	Size	Price
898195	85400	1/2"	32.33
898196	85405	3/4"	35.79
898197	85410	1"	42.53
898198	85415	1-1/4"	76.54
898199	85420	1-1/2"	85.05
898200	85425	2"	108.89

#### Stainless Steel Street 90° Elbows

- Quick Connect Feature
- Stainless Steel 304



Part#	Mfg#	Size	Price
898267	85490	1/2"	29.10
898268	85495	3/4"	32.21
898269	85500	1"	38.28
898270	85505	1-1/4"	68.89
898271	85510	1-1/2"	76.54
898272	85515	2"	98.00

#### Stainless Steel 45° Elbows (P x P)

- Smart Connect Feature
- Stainless Steel 304



Part#	Mfg#	Size	Price
898201	85445	1/2"	32.33
898202	85450	3/4"	35.79
898203	85455	1"	42.53
898204	85460	1-1/4"	76.54
898205	85465	1-1/2"	85.05
898206	85470	2"	108.89

#### Stainless Steel Street 45° Elbows (FTG x P)

- Quick Connect Feature
- Stainless Steel 304



Part#	Mfg#	Size	Price
898273	85535	1/2"	29.10
898274	85540	3/4"	32.21
898275	85545	1"	38.28
898276	85550	1-1/4"	68.89
898277	85555	1-1/2"	76.54
898278	85560	2"	98.00

#### Stainless Steel Couplings with Stop (P x P)

- Smart Connect Feature
- Stainless Steel 304



Part#	Mfg#	Size	Price
898161	85265	1/2" x 3/4"	19.20
898162	85270	3/4"	20.75
898163	85275	1"	23.86
898164	85280	1-1/4"	27.78
898165	85285	1-1/2"	32.67
898166	85290	2"	42.88

#### Stainless Steel Couplings - No Stop (P x P)

- Smart Connect Feature
- Stainless Steel 304



Part#	Mfg#	Size	Price
898167	85310	1/2"	17.28
898168	85315	3/4"	18.68
898169	85320	1"	21.48
898170	85325	1-1/4"	25.00
898171	85330	1-1/2"	29.40
898172	85335	2"	38.58

#### Stainless Steel Tees (P x P x P)

- Quick Connect Feature
- Stainless Steel 304



Part#	Mfg#	Size	Price
898207	85580	1/2"	66.56
898208	85585	3/4"	73.81



## Press Fittings

### ProPress Stainless Steel Fittings (Continued)

#### Stainless Steel Tees (P x P x P)

Part#	Mfg#	Size	Price
898209	85590	1"	78.99
898210	85595	1-1/4"	91.16
898211	85600	1-1/2"	101.29
898212	85605	2"	126.35
898213	85630	3/4" x 1/2"	74.84
898214	85640	1" x 1/2"	77.09
898216	85660	1-1/4" x 1/2"	83.69
898217	85670	1-1/4" x 3/4"	84.63
898218	85680	1-1/4" x 1"	84.94
898219	85690	1-1/2" x 1/2"	92.99
898222	85720	2" x 1/2"	121.17
898223	85730	2" x 3/4"	123.06
898224	85740	2" x 1"	126.70
898225	85750	2" x 1-1/2"	139.65

#### Stainless Steel Tees (P x P x FNPT)

- Quick Connect Feature
- Stainless Steel 304



Part#	Mfg#	Size	Price
898226	85820	3/4" x 1/2"	101.29
898227	85830	3/4" x 3/4"	110.96
898228	85840	1" x 1/2"	111.66
898229	85850	1" x 3/4"	112.35
898231	85870	1-1/4" x 3/4"	115.12
898232	85880	1-1/4" x 1"	125.85
898233	85890	1-1/2" x 1/2"	126.70
898234	85900	1-1/2" x 3/4"	127.90
898235	85910	1-1/2" x 1"	139.83
898236	85920	2" x 1/2"	144.32
898237	85930	2" x 3/4"	146.05
898238	85940	2" x 1"	156.42

#### Stainless Steel Unions (P x P)

- Quick Connect Feature
- Stainless Steel 304



Part#	Mfg#	Size	Price
898261	86005	1/2"	152.31

### ProPress Stainless Steel Fittings (Continued)

#### Stainless Steel Unions (P x P)

Part#	Mfg#	Size	Price
898262	86010	3/4"	172.81
898263	86015	1"	210.45
898264	86020	1-1/4"	324.17
898265	86025	1-1/2"	360.19
898266	86030	2"	359.99

#### Stainless Steel Male Adapters (P x MNPT)

- Smart Connect Feature
- Stainless Steel 304



Part#	Mfg#	Size	Price
898173	85010	1/2"	35.44
898176	85025	3/4"	36.82
898179	85040	1"	43.90
898180	85045	1-1/4"	66.43
898181	85050	1-1/2"	73.81
898182	85055	2"	90.92
898174	85015	1/2" x 3/4"	33.14
898175	85020	3/4" x 1/2"	36.82
898177	85030	3/4" x 1"	42.53
898178	85035	1" x 3/4"	43.90

#### Stainless Steel Female Adapters (P x FNPT)

- Smart Connect Feature
- Stainless Steel 304



Part#	Mfg#	Size	Price
898185	85080	1/2"	43.22
898187	85090	3/4"	44.77
898189	85100	1"	53.24
898190	85105	1-1/4"	90.35
898192	85115	1-1/2"	106.29
898194	85125	2"	115.63
898186	85085	3/4" x 1/2"	43.39
898188	85095	1" x 3/4"	49.96
898193	85120	2" x 1-1/2"	104.92



## Press Fittings

### Stainless Steel Adapter Flanges (P x Flange)

- Quick Connect Feature
- Stainless Steel 304



Part#	Mfg#	Size	Price
898255	86035	1/2"	200.49
898256	86040	3/4"	205.89
898257	86045	1"	209.29
898258	86050	1-1/4"	229.93
898259	86055	1-1/2"	255.48
898260	86060	2"	284.17

### Stainless Steel Reducers (FTG x P)

- Quick Connect Feature
- Stainless Steel 304



Part#	Mfg#	Size	Price
898239	85160	3/4" x 1/2"	60.16
898240	85165	1" x 1/2"	81.23
898241	85170	1" x 3/4"	64.82
898242	85175	1-1/4" x 1/2"	103.14
898243	85180	1-1/4" x 3/4"	96.92
898244	85185	1-1/4" x 1"	53.83
898245	85190	1-1/2" x 1/2"	114.60
898246	85195	1-1/2" x 3/4"	107.69
898247	85200	1-1/2" x 1"	59.80
898249	85205	1-1/2" x 1-1/4"	65.79
898250	85210	2" x 1/2"	213.80
898251	85215	2" x 3/4"	95.76
898252	85220	2" x 1"	73.81
898253	85225	2" x 1-1/4"	66.43
898254	85230	2" x 1-1/2"	73.81

### Stainless Steel Caps (Cap x P)

- Quick Connect Feature
- Stainless Steel 304



Part#	Mfg#	Size	Price
898279	85355	1/2"	35.44
898280	85360	3/4"	26.63
898281	85365	1"	43.90
898282	85370	1-1/4"	69.23
898283	85375	1-1/2"	76.92
898284	85380	2"	90.92



### ProPress Stainless Steel XL™ Fittings

#### Stainless Steel XL-S 90° Elbows (P x P)

- Quick Connect Feature
- XL Fitting
- Stainless Steel 304



Part#	Mfg#	Size	Price
898303	85430	2-1/2"	257.73
898304	85435	3"	240.33
898305	85440	4"	328.25

#### Stainless Steel XL-S Street 90° Elbows (FTG x P)

- Quick Connect Feature
- XL Fitting
- Stainless Steel 304



Part#	Mfg#	Size	Price
898306	85520	2-1/2"	257.73
898307	85525	3"	313.11
898308	85530	4"	427.98

#### Stainless Steel XL-S 45° Elbows (P x P)

- Quick Connect Feature
- XL Fitting
- Stainless Steel 304



Part#	Mfg#	Size	Price
898324	85475	2-1/2"	181.67
898325	85480	3"	225.09
898326	85485	4"	311.07

#### Stainless Steel XL-S Street 45° Elbows (FTG x P)

- Quick Connect Feature
- XL Fitting
- Stainless Steel 304



Part#	Mfg#	Size	Price
898327	85565	2-1/2"	224.75





## Press Fittings

### ProPress Stainless Steel XL™ Fittings (Continued)

#### Stainless Steel XL-S Street 45° Elbows (FTG x P)

Part#	Mfg#	Size	Price
898328	85570	3"	270.32
898329	85575	4"	369.12

#### Stainless Steel XL-S Couplings with Stop (P x P)

- Quick Connect Feature
- XL Fitting
- Stainless Steel 304



Part#	Mfg#	Size	Price
898291	85295	2-1/2"	172.73
898292	85300	3"	190.30
898293	85305	4"	250.01

#### Stainless Steel XL-S Couplings- No Stop (P x P)

- Quick Connect Feature
- XL Fitting
- Stainless Steel 304



Part#	Mfg#	Size	Price
898294	85340	2-1/2"	245.72
898295	85345	3"	277.49
898296	85350	4"	332.87

#### Stainless Steel XL-S Tees (P x P x P)

- Quick Connect Feature
- XL Fitting
- Stainless Steel 304



Part#	Mfg#	Size	Price
898309	85610	2-1/2"	463.81
898310	85615	3"	376.76
898311	85620	4"	490.70
898285	85761	2-1/2" x 1-1/2"	464.13
898312	85760	2-1/2" x 2"	464.18
898289	85772	3" x 1-1/4"	475.47
898288	85771	3" x 1-1/2"	475.47
898313	85770	3" x 2"	423.92
898314	85780	3" x 2-1/2"	417.34
898315	85790	4" x 2"	500.85

### ProPress Stainless Steel XL™ Fittings (Continued)

#### Stainless Steel XL-S Tees (P x P x P)

Part#	Mfg#	Size	Price
898316	85800	4" x 2-1/2"	530.62
898317	85810	4" x 3"	571.73

#### Stainless Steel XL-S Tees (P x P x F)

- Quick Connect Feature
- XL Fitting
- Stainless Steel 304



Part#	Mfg#	Size	Price
898318	85950	2-1/2" x 3/4"	393.67
898319	85960	2-1/2" x 1"	402.84
898320	85970	3" x 3/4"	427.61
898321	85980	3" x 1"	445.47
898322	85990	4" x 3/4"	514.60
898323	86000	4" x 1"	530.31

#### Stainless Steel XL-S Flanges (P x Flange)

- Quick Connect Feature
- XL Fitting
- Stainless Steel 304



Part#	Mfg#	Size	Price
898297	86065	2-1/2"	337.72
898298	86070	3"	369.95
898299	86075	4"	490.70

#### Stainless Steel XL-S Male Adapters (P x MNPT)

- Quick Connect Feature
- XL Fitting
- Stainless Steel 304



Part#	Mfg#	Size	Price
898300	85060	2-1/2"	235.76
898301	85065	3"	260.15
898302	85070	4"	340.98



## Press Fittings

### Stainless Steel XL-S Reducers (FTG x P)

- Quick Connect Feature
- XL Fitting
- Stainless Steel 304



Part#	Mfg#	Size	Price
898330	85235	2-1/2" x 2"	142.65
898331	85240	3" x 2"	154.13
898332	85245	3" x 2-1/2"	210.09
898333	85250	4" x 2"	199.13
898334	85255	4" x 2-1/2"	223.53
898335	85260	4" x 3"	241.87

### Stainless Steel XL-S Caps (Cap x P)

- Quick Connect Feature
- XL Fitting
- Stainless Steel 304



Part#	Mfg#	Size	Price
898336	85385	2-1/2"	161.51
898337	85395	3"	267.16
898338	85390	4"	348.31



### Stainless Steel 304 Pipe (20 Ft. Lengths)



- Thin wall for use with ProPress stainless steel fittings
- 304 Grade
- Available in 20' lengths only.

Part#	Mfg#	Size	Price
899007	87000	1/2" x 20'	83.52
899013	87005	3/4" x 20'	104.78
899014	87010	1" x 20'	160.13
899015	87015	1-1/4" x 20'	197.82
899020	87020	1-1/2" x 20'	219.64
899022	87025	2" x 20'	273.20
899023	87030	2-1/2" x 20'	387.19
899024	87035	3" x 20'	455.13
899026	87040	4" x 20'	612.35

CELEBRATING  
**75** YEARS  
 1934 • 2010

Metropolitan Pipe recently celebrated 75 years of operation. Our staff, with over a century of combined experience, is always ready to tackle your next job. No one knows the industry better!



## Tools



### Pressing Tools

#### RP 330-B Press Tool

- For convenience and portability, the RP 330-B is the logical choice. Featuring a barrel that rotates 270 degrees and a longer service interval, the RP 330-B is designed to handle your toughest construction projects. Powered by a 18V Lithium-Ion Battery, the RP 330-B offers more presses per battery charge than ever before.
- Capacity: 1/2" – 4"
- 270° Barrel/Jaw swivel
- Battery: 18V Li-Ion
- Battery charger: 115V
- Hydraulic ram output: 7,200 lbs. (32kN)
- Weight: 10.0 lbs. w/ battery
- Operating temperature range: 14°F to 122°F
- Approximate cycle time: 5 seconds



Part #	Mfg #	Description	Price
913273	27923	Kit: 1/2" - 2" Jaw Set, Case, 2 Batteries & Battery Charger	3390.10

#### RP 330-C Press Tool

- Want peace of mind from your press tool? The RP 330-C features the same reliability and durability of the RP 330-B with the added confidence a power cord offers. At nearly half the weight of the previous corded unit, this is our lightest corded press tool ever.
- Capacity: 1/2" – 4"
- 270° Barrel/JawsSwivel
- Hydraulic ram output: 7,200 lbs. (32kN)
- Weight: 9 lbs.
- Operating temperature range: 14°F to 122°F
- Approximate cycle time: 5 seconds



Part #	Mfg #	Description	Price
912592	27948	Kit: 1/2" - 2" Jaw Set, Case	2887.70

#### RP 210-B Press Tool

- Say "hello" to your little friend! RIDGID® introduces the ultimate in press tool technology: the RP 210-B. For a fast and reliable way to join copper, stainless steel and PEX, the new RP 210-B has more capacity than any compact press tool on the market. This model is 2 inches shorter and 25% lighter than our previous compact tool and features the longest service interval available (32,000 cycles), an improved swiveling barrel and a powerful 18V Lithium-Ion battery. Now you can do more... with less!
- Capacity: 1/2" – 1-1/4" (Copper & Stainless Steel), 3/8" - 1 1/2" (PEX)
- 270° Barrel/Jaw swivel
- Battery: 18V Li-Ion 1.1Ah
- Weight: 6.4 lbs. with battery
- Battery charger: 115V
- Hydraulic ram output: 5,400 lbs. (24kN)
- Operating temperature range: 15°F to 122°F
- Approximate cycle time: 5 seconds



Part #	Mfg #	Description	Price
918238	31028	Kit: 1/2" - 1-1/4" Jaw Set, Case, 2 Batteries & Battery Charger	2237.10

Prices & specifications are subject to change.

We offer a variety of GREEN products such as flush valves, faucets, showerheads & more!



## Tools



### Pressing Rings

#### Standard Series XL-C Press Rings

- For use with ProPress systems; patented
- For use with ProPress XL-C copper fittings
- Works with V2 actuator and provides increased flexibility in tight spaces, swivels nearly 180° with XL-C press rings



Part #	Mfg #	Description	Price
886970	20483	2-1/2" - 4" Pressing Rings, Actuator, & Case	2533.30

#### Standard Series XL Press Rings

- For use with ProPress XL bronze fittings
- Spring-loaded to remain in place
- Works with the R2 actuator on all standard series pressing tools to make connections of 2-1/2" to 4" tube



Part #	Mfg #	Description	Price
233523	93667	2-1/2" - 4" Pressing Rings, Actuator, & Case	2533.30

### Pressing Jaws

#### Standard Series Jaws for ProPress Systems

- Total system compatibility with the ProPress System fittings
- Compatible only with Ridgid Standard Series pressing tools
- Backed by full Ridgid Lifetime Warranty
- For use with copper



Part #	Mfg #	Description	Price
893683	76652	1/2" Jaw	194.90
893684	76657	3/4" Jaw	194.90
893682	76662	1" Jaw	194.90
867554	76667	1-1/4" Jaw	194.90
876580	76672	1-1/2" Jaw	249.95
876582	76677	2" Jaw	273.65

#### Compact Series Jaws for ProPress Systems

- 40% Lighter and 33% Smaller than Standard Series Jaws enabling them to fit into tight spaces.
- Compatible only with Ridgid Compact Series Pressing tools

Part #	Mfg #	Description	Price
931676	16958	1/2" Jaw	192.31
931677	16963	3/4" Jaw	192.31
931678	16978	1" Jaw	192.31
931679	31228	1-1/4" Jaw	203.85



## Tools



### Standard Series Jaws for PureFlow™ Systems

- Total system compatibility with the PureFlow System fittings
- Compatible only with Ridgid Standard Series pressing tools
- Backed by full Ridgid lifetime warranty
- Compatible with:  
Viega Pexcel PureFlow Plumbing Systems  
Viega Radiant Heating Systems  
Viega Snow Melting Systems



Part #	Mfg #	Description	Price
907936	22653	1/2" Jaw	222.39
907937	22658	5/8" Jaw	222.39
907938	22663	3/4" Jaw	222.39
907939	22668	1" Jaw	222.39
907940	22673	1-1/4" Jaw	228.30
907941	22678	1-1/2" Jaw	291.83

### Compact Series Jaws for PureFlow™ Systems

- 40% Lighter and 33% Smaller than the Standard Series Jaws
- Compatible only with Ridgid Compact Series pressing tool

Part #	Mfg #	Description	Price
907926	17003	3/8" Jaw	1304.25
907927	17008	1/2" Jaw	165.50
907928	19813	5/8" Jaw	165.50
907929	17013	3/4" Jaw	165.50
907930	17018	1" Jaw	165.50
907934	22683	1-1/4" Jaw	209.09
907935	22688	1-1/2" Jaw	231.25



**Metropolitan Pipe** is proud to be a member of the nationwide *Embassy Group*.

Our participation in this group allows us to extend better pricing and stock availability to you.



## Acid Waste

### Acid Waste Pipe No-Hub/Rionfuse CF®



Blueline Sch 40 Polypropylene Pipe - 10' Lengths

Part #	Mfg #	Size	Price
111686	0110156440	1-1/2"	5.15
111687	0110206440	2"	7.05
111688	0110306440	3"	12.75
45474	0110406440	4"	18.00
115348	0110606440	6"	30.54

### Acid Waste Couplings

#### No-Hub (Mechanical Joint) Couplings

- All fittings pre-grooved at factory
- No heat or hot water required
- Reusable
- Stainless steel outer coupling
- No metal in joint
- Suitable for below ground applications



Part #	Mfg #	Size	Price
857420	11101501	1-1/2"	4.91
857421	11102001	2"	6.29
857422	11103001	3"	9.43
857423	11104001	4"	15.86
857424	11106001	6"	29.64

#### Rionfuse CF® (Clamp-Free) Electrofusion Couplings

- No clamps required
- Strongest joint in the industry
- Multiple joint capabilities
- Non-corrosive polypropylene
- Continuous coil throughout coupling
- Use Rionfuser® power unit to fuse
- Can be used above and below ground



Part #	Mfg #	Size	Price
857482	131101501	1-1/2"	7.43
857481	131102001	2"	9.33
857425	131103001	3"	11.13
857426	131104001	4"	14.89
857427	131106001	6"	42.11

### Acid Waste Fittings

#### No-Hub/Rionfuse CF®

- All fittings are sold as plain end
- Couplings must be purchased separately

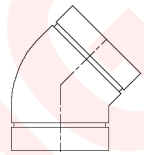

#### 45° Elbows - 1/8 Bends

Part #	Mfg #	Size	Price
857212	01101502	1-1/2"	8.36
857233	01102002	2"	10.23
857264	01103002	3"	26.91
857298	01104002	4"	47.12
857336	01106002	6"	70.88

#### 90° Elbows - 1/4 Bends

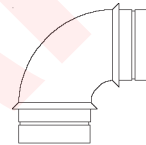

Part #	Mfg #	Size	Price
857206	01101503	1-1/2"	9.12
857207	01102003	2"	10.99
857265	01103003	3"	26.15
857299	01104003	4"	49.05
857337	01106003	6"	102.24

#### Sanitary Tees - TY - 90° Tee

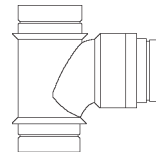

Part #	Mfg #	Size	Price
857213	01101505	1-1/2"	12.27
857234	01102005	2"	22.25
857266	01103005	3"	34.68
857300	01104005	4"	57.52

#### Reducing Sanitary Tees - TY

Part #	Mfg #	Size	Price
857258	011021506	2" x 1-1/2"	12.44
857293	011031506	3" x 1-1/2"	34.86
857277	011030206	3" x 2"	41.56
857311	011040206	4" x 2"	65.01
857320	011040306	4" x 3"	72.99



## Acid Waste



### Dandy Clean Out Tees with Plug

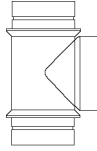

Part #	Mfg #	Size	Price
857214	01101507	1-1/2"	25.60
857235	01102007	2"	32.33
857267	01103007	3"	55.99
857301	01104007	4"	78.55
857338	01106007	6"	263.65

### 45° Wyes

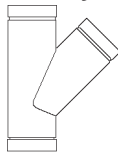

Part #	Mfg #	Size	Price
857215	01101508	1-1/2"	7.98
857236	01102008	2"	13.58
857268	01103008	3"	39.21
857302	01104008	4"	58.27
857339	01106008	6"	125.49

### Reducing 45° Wyes

Part #	Mfg #	Size	Price
857259	011021509	2" x 1-1/2"	19.49
857294	011031509	3" x 1-1/2"	48.84
857278	011030209	3" x 2"	55.89
857332	011041509	4" x 1-1/2"	87.25
857312	011040209	4" x 2"	91.54
857321	011040309	4" x 3"	99.07
857358	011060409	6" x 4"	202.10

### Long Turn Tee Wyes

- Combination wye and 1/8 bend

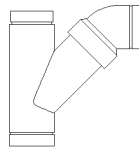

Part #	Mfg #	Size	Price
857216	01101510	1-1/2"	16.79
857237	01102010	2"	16.02
857269	01103010	3"	48.95
857303	01104010	4"	71.19
857340	01106010	6"	268.82

### Reducing Long Turn Wyes

- Combination reducing wye and 1/8 bend

Part #	Mfg #	Size	Price
857260	011021511	2" x 1-1/2"	24.70
857279	011030211	3" x 2"	56.51
857313	011040211	4" x 2"	34.23
857322	011040311	4" x 3"	102.90

### Double Wyes

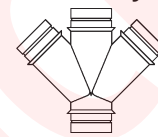

Part #	Mfg #	Size	Price
857239	01102013	2"	54.72
857271	01103013	3"	76.51
857305	01104013	4"	100.00

### Reducing Double Wyes

Part #	Mfg #	Description	Price
857280	011030214	3" x 2"	107.60
857323	011040314	4" x 3"	132.98
857261	011021514	2" x 1-1/2"	95.30

### Double Reducing Long Turn Tee Wyes

- Combination double reducing wye and 1/8 bends

Part #	Mfg #	Size	Price
858491	011021516	2" x 1-1/2"	117.51
857281	011030216	3" x 2"	58.39
857324	011040316	4" x 3"	130.77

### Male Adapters

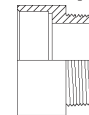

Part #	Mfg #	Size	Price
857220	01101517	1-1/2"	7.43
857241	01102017	2"	7.91
857273	01103017	3"	17.97
857307	01104017	4"	41.07



## Acid Waste

### Female Adapters

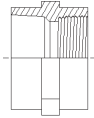

Part #	Mfg #	Size	Price
857221	01101518	1-1/2"	8.26
857242	01102018	2"	12.61
857274	01103018	3"	26.91
857308	01104018	4"	44.04

### Clean Out Adapters with Plug

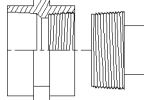

Part #	Mfg #	Size	Price
857243	01102019	2"	21.01
857275	01103019	3"	46.36
857309	01104019	4"	70.99
857345	01106019	6"	150.67

### Clean Out Plugs

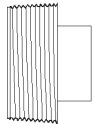

Part #	Mfg #	Size	Price
857223	01101520	1-1/2"	5.29
857244	01102020	2"	8.43
857276	01103020	3"	19.45
857310	01104020	4"	26.98

### Caps



Part #	Mfg #	Size	Price
857462	01101521	1-1/2"	16.20
857463	01102021	2"	17.86
857464	01103021	3"	30.23
857465	01104021	4"	47.71
857466	01106021	6"	50.16

### Reducing Bushings

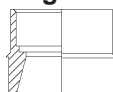

Part #	Mfg #	Size	Price
857478	011021522	2" x 1-1/2"	15.48
857468	011031522	3" x 1-1/2"	16.72

### No-Hub/Rionfuse CF®

#### Reducing Bushings (Continued)

Part #	Mfg #	Size	Price
857469	011030222	3" x 2"	17.38
857467	011040222	4" x 2"	34.27
857473	011040322	4" x 3"	35.37
857476	011060422	6" x 4"	59.38

### Adapters (Duriron x Spigot)

- Must use Duriron clamp

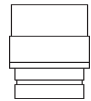

Part #	Mfg #	Size	Price
857224	01101523	1-1/2"	20.56
857245	01102023	2"	24.84
857282	01103023	3"	27.78
857316	01104023	4"	35.44

### Duriron Mechanical Joint Couplings

- Designed for fast & easy assembly or disassembly through the use of a 2-bolt mechanical coupling
- An ordinary ratchet is necessary to complete the joint
- Tighten nuts to a minimum of 9 ft-lbs torque before testing

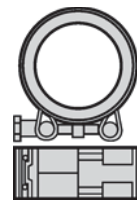

Part #	Mfg #	Description	Price
7770	MJ112A	1-1/2"	58.95
7771	MJ2A	2"	79.70
7772	MJ3A	3"	83.85
7773	MJ4A	4"	95.20

### Union P-Traps

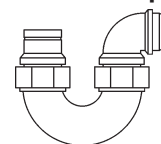

Part #	Mfg #	Model	Size	Price
857225	01101525	UTP	1-1/2"	42.39
857247	01102025	UTP	2"	69.08





## Acid Waste



### P-Traps

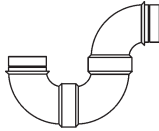

Part #	Mfg #	Model	Size	Price
857284	01103028	RBP	3"	77.76
857318	01104028	RBP	4"	166.00

### Sink Tail Piece Adapters



Part #	Mfg #	Model	Size	Price
858164	01101530	RLNS	1-1/2"	19.28

### Sink Tail Piece Extensions



Part #	Mfg #	Size	Price
858536	01101531	1-1/2" x 12"	33.68

### Slip Joint Adapters - Desanco

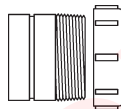

Part #	Mfg #	Size	Price
857230	01101532	1-1/2"	18.83

### Flanges



Part #	Mfg #	Size	Price
857231	01101535	1-1/2"	13.58
857253	01102035	2"	67.70
857286	01103035	3"	110.26
857325	01104035	4"	135.54
857357	01106035	6"	176.95

### Waste Assemblies

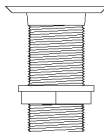

Part #	Mfg #	Size	Price
54160	WA-1	1-1/2" IPS x 2.48" W	26.70
114527	WA-2	1-1/2" IPS x 3.24" W	29.26
114529	WA-3	1-1/2" IPS x 4.14" W	37.17

### Cup Sinks - Oval

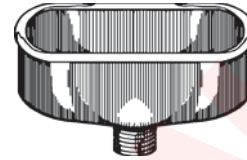

Part #	Mfg #	Model	Size	Price
36084	81393441	CS5	9" x 3" x 4"	37.62

### Floor Cleanout

- Adjustable top for finished floors



Part #	Mfg #	Description	Price
857208	01103044	4" Round Nickel Bronze CO	297.22

### Floor Drains

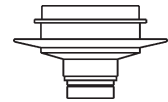

Part #	Mfg #	Model	Size	Price
857255	01102045	FD-1	2"	267.17
857290	01103045	FD-1	3"	292.94
857328	01104045	FD-1	4"	318.50

### Mechanical Joint Tools

#### Grooving Tools

Part #	Mfg #	Size	Price
54155	MJGT1	1-1/2"	119.40
47710	MJGT2	2"	149.80
114542	MJGT3	3"	197.40
112883	MJGT4	4"	231.20
153352	MJGT6	6"	874.00

#### Groover Repair Kits

- Kit includes:
  - Blade
  - Cam assembly
  - Cover
  - Screw

Part #	Mfg #	Description	Price
116500	REPAIR	Groover Repair Kit	47.50

Prices & specifications are subject to change.

Metropolitan Pipe offers Vendor Managed Inventory - never run out of that part again!



## Acid Waste

### Neutralization & Dilution Tanks

- Tanks are free standing and self supporting

#### Style 5 - Bolted Top Tanks

- 4" Cleanout
- Other tank sizes and styles available.  
Please call for more information.

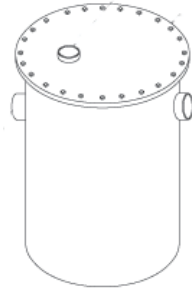

Part #	Mfg #	Size	Ht	Inlet/Outlet	Price
114554	5-222-5	5 gal	16.25"	2" FIP	668.00
36150	5-332-15	15 gal	15.5"	3" FIP	965.00

**Metropolitan Pipe RENTS Orion Fusing Machines! Ask a salesman for details.**





## Pipe



**PVC Pipe**

### Sch 40 PVC - 20' Lengths

Part #	Size	Price
480	1/2"	0.44
481	3/4"	0.49
482	1"	0.80
507	1-1/4"	0.66
508	1-1/2"	0.70
509	2"	0.97
483	2-1/2"	2.37
510	3"	1.90
511	4"	2.66
484	5"	10.91
512	6"	6.02
513	8"	7.39
514	10"	12.00
515	12"	17.68

### Sch 80 PVC - 20' Lengths

Part #	Size	Price
489	1/2"	0.97
490	3/4"	1.29
491	1"	1.90
492	1-1/4"	2.67
493	1-1/2"	2.94
494	2"	4.14
495	2-1/2"	6.81
496	3"	8.35
497	4"	12.03
498	6"	23.18
499	8"	34.94

### DWV Sch 40 PVC - 10' Lengths

Part #	Size	Price
517	1-1/2"	0.70
518	2"	0.97
519	3"	1.90
520	4"	2.66
521	6"	6.02



## DWV Fittings

### PVC DWV Fittings

#### Couplings - PVC (Hub)



Part #	Size	Price
8897	1-1/2"	0.88
8898	2"	1.13
8899	3"	3.91
8900	4"	6.93
8901	6"	22.56
36354	8"	49.69
8902	2" x 1-1/2"	2.53
8904	3" x 2"	5.91
8905	4" x 2"	11.70
8906	4" x 3"	12.45

#### Repair Couplings - PVC (Hub)



Part #	Size	Price
8907	1-1/2"	4.74
8908	2"	3.31
8909	3"	8.34
8910	4"	16.07

#### Fitting Flush Bushings - PVC (Spigot x Hub)



Part #	Size	Price
8911	2" x 1-1/2"	1.50
8912	3" x 1-1/2"	7.19
8913	3" x 2"	3.76
8914	4" x 2"	12.51
8915	4" x 3"	6.39

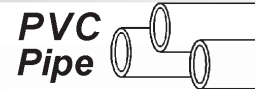

## PVC Pipe

### Fitting Flush Bushings - PVC (Spigot x Hub) (Continued)

Part #	Size	Price
8916	6" x 4"	33.19

### Ftg Slip Joint Trap Adapters with Plastic Nut - PVC (Spigot x SJ)

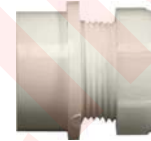

Part #	Size	Price
8941	1-1/2"	3.21
8942	1-1/2" x 1-1/4"	3.54

### Slip Joint Trap Adapters - PVC (Hub x SJ)

Part #	Size	Price
8940	1-1/2"	3.09
8943	1-1/2" x 1-1/4"	3.21

### Female Adapters - PVC (Hub x FIP)



Part #	Size	Price
8921	1-1/2"	1.63
8922	2"	2.76
8923	3"	7.44
8924	4"	9.53

### Male Adapters - PVC (Hub x MIP)



Part #	Size	Price
8917	1-1/2"	1.69
8918	2"	2.20
8919	3"	6.29
8920	4"	13.94

Prices & specifications are subject to change.



## PVC DWV Fittings



### No-Hub Soil Adapters - PVC (Hub x No-Hub)

Part #	Size	Price
8937	2"	4.52
8938	3"	6.58
8939	4"	8.45

### Cast Iron Hub Adapters - PVC (Hub x SJ)

Part #	Size	Price
8929	2"	8.50
8930	3"	15.23
8931	4"	24.49

### Cast Iron Hub Adapter - PVC (Hub x Spigot)

Part #	Size	Price
8932	2" x 1-1/2"	12.62
8933	3" x 1-1/2"	13.98
8934	3" x 2"	12.43
8935	4" x 3"	17.37

### Test Caps - PVC



Part #	Size	Price
9047	1-1/2"	1.91
9048	2"	1.73
9049	3"	2.11
9050	4"	2.63

### Expansion Joints - PVC (Hub)

Part #	Size	Price
8925	1-1/2"	100.12
8926	2"	75.30
8927	3"	92.79
8928	4"	202.41

### 90° Elbows - PVC (Hub)



Part #	Size	Price
8944	1-1/2"	1.75
8945	2"	2.76
8946	3"	8.14
8947	4"	16.03
8948	6"	56.27

### 90° Street Elbows - PVC (Spigot x Hub)



Part #	Size	Price
8953	1-1/2"	2.35
8954	2"	3.57
8955	3"	9.02
8956	4"	16.95
8957	6"	78.38

### 90° Side Inlet Elbows - PVC (Hub)



Part #	Size	Price
8958	3" x 3" x 2"	16.60

### 90° Long Turn Elbows - PVC (Hub)



Part #	Size	Price
8949	1-1/2"	4.20
8950	2"	4.55
8951	3"	10.71
8952	4"	20.44

### 45° Elbows - PVC (Hub)



Part #	Size	Price
92218	1-1/4"	2.42
8963	1-1/2"	1.72
8964	2"	2.47
8965	3"	7.28
8966	4"	12.78
8967	6"	51.50
45905	8"	92.11

### 45° Street Elbows - PVC (Spigot x Hub)



Part #	Size	Price
8968	1-1/2"	1.70
8969	2"	2.62
8970	3"	7.14
8971	4"	12.20
8972	6"	63.07

### 22-1/2° Elbows - PVC (Hub)



Part #	Size	Price
8973	1-1/2"	2.42
8974	2"	3.00
8975	3"	7.66
8976	4"	11.70
52788	6"	70.30



## PVC DWV Fittings



### 22-1/2° Street Elbows - PVC (Spigot x Hub)



Part #	Size	Price
8977	1-1/2"	6.82
8978	2"	7.30
8979	3"	11.49
8980	4"	16.74
156667	6"	68.10

### 60° Elbows - PVC (Hub)



Part #	Size	Price
8959	1-1/2"	3.83
8960	2"	4.91
8961	3"	15.63
8962	4"	24.18

### 45° Wyes - PVC (Hub)



Part #	Size	Price
9010	1-1/2"	5.98
9011	2"	5.68
9012	3"	15.34
9013	4"	27.82
9014	6"	83.97
53647	8"	142.71
9016	2" x 1-1/2" x 1-1/2"	8.02
9017	2" x 1-1/2" x 2"	12.28
9015	2" x 2" x 1-1/2"	6.98
9018	3" x 3" x 1-1/2"	10.04
9019	3" x 3" x 2"	11.34
9021	4" x 4" x 2"	16.75
9022	4" x 4" x 3"	22.58
9023	6" x 6" x 4"	61.71

### 45° Street Wyes - PVC (Spigot x Hub x Hub)

Part #	Size	Price
232462	1-1/2"	10.10

### Sanitary Tees - PVC (Hub)



Part #	Size	Price
8981	1-1/2"	3.19
8982	2"	4.66
8983	3"	12.26
8984	4"	21.77
8985	6"	90.81
9002	2" x 1-1/2" x 1-1/2"	4.09
9003	2" x 1-1/2" x 2"	4.97
8995	2" x 2" x 1-1/2"	4.13
8996	3" x 3" x 1-1/2"	8.67
8997	3" x 3" x 2"	9.16
8999	4" x 4" x 2"	19.46
9000	4" x 4" x 3"	26.45
9001	6" x 6" x 4"	87.82

### Cleanout Tees with Plug - PVC (Hub)

Part #	Size	Price
9033	1-1/2"	8.02
9034	2"	9.25
9035	3"	17.68
9036	4"	30.75

### Street Tees - PVC (Spigot x Hub x Hub)

Part #	Size	Price
118737	1-1/2"	6.24

### Comb Long Radius TYs - PVC (Hub)



Part #	Size	Price
202591	3"	22.04
202590	3" x 3" x 2"	14.57

### Cleanouts with Plug - PVC (Spigot x Cleanout)



Part #	Size	Price
9037	1-1/2"	3.60
9038	2"	4.36
9039	3"	10.53
9040	4"	16.77
9041	6"	50.75

### Plugs - PVC (MIP)



Part #	Size	Price
9042	1-1/2"	1.54
9043	2"	1.71
9044	3"	3.07
9045	4"	4.52
9046	6"	15.03

### 45° Double Wyes - PVC (Hub)



Part #	Size	Price
9024	1-1/2"	12.95
9025	2"	14.96
9026	3"	30.41
9027	4"	61.69

Prices & specifications are subject to change.

Our office hours are 7am to 4:30pm and counter hours 6am to 4:30pm Monday through Friday.



## PVC DWV Fittings



### 45° Double Wyes - PVC (Hub) (Continued)

Part #	Size	Price
9028	2" x 2" x 1-1/2" x 1-1/2"	13.20
9030	3" x 3" x 2" x 2"	22.66
9031	4" x 4" x 2" x 2"	36.98
9032	4" x 4" x 3" x 3"	48.85

### Double Sanitary Tees - PVC (Hub)



Part #	Size	Price
8986	1-1/2"	7.05
8987	2"	9.52
8988	3"	26.60
8989	4"	42.78
8990	2" x 2" x 1-1/2" x 1-1/2"	7.19
8992	3" x 3" x 2" x 1-1/2"	16.07
8993	4" x 4" x 2" x 2"	35.38
8994	4" x 4" x 3" x 3"	29.37

### Double Tees with Right & Left Inlets - PVC (Hub) Estabrook



Part #	Size	Price
140369	3" x 3" x 3" x 3" x 2" x 2"	18.30

### Double Tees with 90° Inlet - PVC (Hub) Estabrook



Part #	Size	Price
117594	3" x 3" x 3" x 3" x 2"	35.03

### Comb Wye & 1/8 Bend - Left Inlet - PVC (Hub)

Part #	Size	Price
9005	3" x 3" x 3" x 2"	22.28
9006	4" x 4" x 4" x 2"	50.24

### Comb Wye & 1/8 Bend - Right Inlet - PVC (Hub)

Part #	Size	Price
9008	3" x 3" x 3" x 2"	22.28
9009	4" x 4" x 4" x 2"	50.24

### Double 90° Elbows - PVC (Hub)



Part #	Size	Price
151001	2" x 2" x 1-1/2"	8.97

### P-Traps - PVC (Hub)



Part #	Size	Price
9057	1-1/2"	6.08
9060	2"	8.20
9061	3"	27.79
9062	4"	63.36

### P-Traps with Plug - PVC (Hub x Hub x Cleanout)



Part #	Size	Price
9058	1-1/2"	10.04
9059	2"	17.02

### Drum Traps with Cleanout - PVC (Hub)

Part #	Size	Price
9063	3" x 6" x 1-1/2"	24.60

### Closet Flanges - PVC (Hub)



Part #	Size	Price
9051	4" x 3"	9.37

### Adj Closet Flanges with Metal Ring - PVC (Hub)



Part #	Size	Price
9054	4"	21.51

### Adj Ftg Closet Flanges with Metal Ring - PVC (Spigot)

Part #	Size	Price
9055	4" x 3"	18.70

### Offset Adj Closet Flanges - PVC (Hub)



Part #	Size	Price
9056	4" x 3" w/Metal Ring	24.67

## PVC 40 Fittings



### PVC Schedule 40 Fittings

#### Tees - PVC (Socket)



Part #	Size	Price
9197	1/2"	0.47
9198	3/4"	0.54
9199	1"	1.00
9200	1-1/4"	1.56
9201	1-1/2"	1.90

Prices & specifications are subject to change.



## PVC Schedule 40 Fittings



### Tees - PVC (Socket) (Continued)

Part #	Size	Price
9202	2"	2.76
9203	2-1/2"	9.11
9204	3"	11.96
9205	4"	21.64
9207	6"	72.79
9208	8"	168.81
92021	10"	915.24
57285	12"	1352.32

### Reducing Tees - PVC (Socket)



Part #	Size	Price
9209	3/4" x 1/2"	0.62
9210	1" x 1/2"	1.06
9211	1" x 3/4"	1.16
9212	1-1/4" x 1/2"	1.72
9213	1-1/4" x 3/4"	1.72
9214	1-1/4" x 1"	1.72
9216	1-1/2" x 3/4"	3.01
9217	1-1/2" x 1"	3.01
9218	1-1/2" x 1-1/4"	3.01
9219	2" x 3/4"	2.96
9220	2" x 1"	2.96
9221	2" x 1-1/4"	2.96
9222	2" x 1-1/2"	2.96
112799	3" x 1-1/2"	21.28
156646	6" x 2"	119.10
112690	12" x 8"	942.33

### 90° Elbows - PVC (Socket)



Part #	Size	Price
9159	3/8"	0.52
9160	1/2"	0.38
9161	3/4"	0.42
9162	1"	0.76

### 90° Elbows - PVC (Socket) (Continued)

Part #	Size	Price
9163	1-1/4"	1.33
9164	1-1/2"	1.43
9165	2"	2.24
9166	2-1/2"	6.81
9167	3"	8.15
9168	4"	14.57
9169	5"	37.65
9170	6"	46.33
9171	8"	119.30
37496	10"	735.22
50644	12"	986.07

### Reducing 90° Elbows - PVC (Socket)

Part #	Size	Price
9175	1-1/2" x 1-1/4"	3.37

### 90° Street Elbows - PVC (Spigot x Socket)



Part #	Size	Price
9190	1/2"	1.06
9191	3/4"	1.30
9192	1"	2.24
9193	1-1/4"	2.68
9194	1-1/2"	2.96
9195	2"	5.70

### 45° Elbows - PVC (Socket)



Part #	Size	Price
229264	3/8"	0.62
9178	1/2"	0.62
9179	3/4"	0.96
9180	1"	1.16
9181	1-1/4"	1.60
9182	1-1/2"	2.01
9183	2"	2.62

### 45° Elbows - PVC (Socket) (Continued)

Part #	Size	Price
9184	2-1/2"	6.82
9185	3"	10.59
9186	4"	18.98
9188	6"	46.89
9189	8"	112.76
139881	10"	480.32
48371	12"	711.78

### Couplings - PVC (Socket)



Part #	Size	Price
9075	1/2"	0.25
9076	3/4"	0.34
9077	1"	0.60
9078	1-1/4"	0.82
9079	1-1/2"	0.88
9080	2"	1.34
9081	2-1/2"	2.96
9082	3"	4.63
9083	4"	6.69
9084	5"	12.25
9085	6"	21.14
9086	8"	39.47
119176	10"	188.24
115061	12"	375.05

### Reducer Couplings - PVC (Socket)

Part #	Size	Price
9087	3/4" x 1/2"	0.62
9088	1 x 3/4"	1.06

### Adapters - PVC (Socket x FIP)



Part #	Size	Price
9133	1/2"	0.42
9134	3/4"	0.54
9135	1"	0.62

Prices & specifications are subject to change.

You can check stock availability, pricing and place orders online at [www.MetPipe.com](http://www.MetPipe.com).



## PVC Schedule 40 Fittings



### Adapters - PVC (Socket x FIP) (Continued)

Part #	Size	Price
9136	1-1/4"	0.96
9137	1-1/2"	1.10
9138	2"	1.47
9139	2-1/2"	3.72
9140	3"	5.00
9141	4"	8.28
9142	6"	30.45

### Adapters - PVC (Spigot x FIP)

Part #	Size	Price
9154	3/4"	0.55
9155	1"	0.88
9156	1-1/4"	1.23
9157	1-1/2"	1.53
9158	2"	2.24

### Adapters - PVC (MIP x Socket)



Part #	Size	Price
9143	1/2"	0.34
9144	3/4"	0.38
9145	1"	0.67
9146	1-1/4"	0.82
9147	1-1/2"	1.10
9148	2"	1.44
9149	2-1/2"	4.24
9150	3"	6.20
9151	4"	7.91
9152	6"	20.61

### Flush Style Reducer Bushings - PVC (Spigot x Socket)



Part #	Size	Price
9090	3/4" x 1/2"	0.40
9091	1" x 1/2"	0.71
9092	1" x 3/4"	0.71

### Flush Style Reducer Bushings - PVC (Spigot x Socket) (Continued)

Part #	Size	Price
9093	1-1/4" x 1/2"	0.96
9094	1-1/4" x 3/4"	0.96
9095	1-1/4" x 1"	0.96
9096	1-1/2" x 1/2"	1.01
9097	1-1/2" x 3/4"	1.01
9098	1-1/2" x 1"	1.01
9099	1-1/2" x 1-1/4"	1.01
9100	2" x 1/2'	1.68
9101	2" x 3/4"	1.68
9102	2" x 1"	1.68
9103	2" x 1-1/4"	1.68
9104	2" x 1-1/2"	1.68
54336	2-1/2" x 1"	2.69
9105	2-1/2" x 1-1/2"	2.69
9106	2-1/2" x 2"	2.69
9107	3" x 1-1/2"	3.95
9108	3" x 2"	3.95
9109	3" x 2-1/2"	3.95
9112	4" x 2"	8.85
9114	4" x 3"	8.85
173548	5" x 4"	20.34
9115	6" x 4"	21.90
132899	10" x 6"	340.00
36438	10" x 8"	340.00
112709	12" x 8"	378.12
213279	12" x 10"	378.12

### Flush Style Reducer Bushings - PVC (Spigot x FIP)



Part #	Size	Price
9118	3/4" x 1/2"	0.62
9120	1" x 3/4"	1.00
9121	1-1/4" x 1/2"	1.54
9122	1-1/4" x 3/4"	1.54
9123	1-1/4" x 1"	1.54
9124	1-1/2" x 1/2"	1.77
9125	1-1/2" x 3/4"	1.77
9126	1-1/2" x 1"	1.77
9127	1-1/2" x 1-1/4"	1.77
9128	2" x 1/2'	2.38

### Flush Style Reducer Bushings - PVC (Spigot x FIP) (Continued)

Part #	Size	Price
9129	2" x 3/4"	2.38
9130	2" x 1"	2.38
9131	2" x 1-1/4"	2.38
9132	2" x 1-1/2"	2.38

### Caps - PVC (Socket)



Part #	Size	Price
9223	3/8"	1.56
9224	1/2"	0.34
9225	3/4"	0.40
9226	1"	0.62
9227	1-1/4"	0.88
9228	1-1/2"	0.96
9229	2"	1.16
9230	2-1/2"	3.66
9231	3"	4.01
9232	4"	9.11
9234	6"	21.82

### Plugs - PVC (Spigot)



Part #	Size	Price
9235	1/2"	0.82
9236	3/4"	0.96
9237	1"	1.16
9238	1-1/4"	1.14
9239	1-1/2"	2.44
9240	2"	1.92
9241	2-1/2"	6.77

### Plugs - PVC (MIP)

Part #	Size	Price
55488	3/4"	1.09
111761	1"	1.77
54373	1-1/4"	1.87

Prices & specifications are subject to change.





## PVC Schedule 40 Fittings



### P-Trap - PVC

Part #	Size	Price
9244	3/4"	2.72



### Plastic Backwater Valves



- Reduces backflow in drainage system
- Flapper and cover have elastomeric gasket to ensure watertight seal
- Stepped construction encourages flow (minimum 1/4" per foot fall)
- Threaded access cover for easy inspection and cleaning of drain line
- Sockets are Sch 40 DWV

Part #	Size	Price
9819	3" PVC	39.89
9820	4" PVC	49.00
48769	6" PVC	240.93

### Tees - PVC (FIP) (Continued)

Part #	Size	Price
9582	3"	51.39
9583	4"	83.51

### 90° Elbows - PVC (FIP)



Part #	Size	Price
9551	1/4"	3.03
9553	1/2"	2.83
9554	3/4"	3.53
9555	1"	4.44
9556	1-1/4"	4.78
9557	1-1/2"	6.77
9558	2"	7.63
9559	2-1/2"	29.70
9560	3"	47.89
9561	4"	84.27

### Couplings - PVC (FIP)

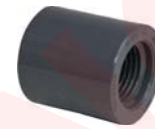

Part #	Size	Price
9492	1/4"	2.65
9493	3/8"	2.65
9494	1/2"	2.48
9495	3/4"	3.53
9496	1"	3.79
9497	1-1/4"	4.69
9498	1-1/2"	10.42
9499	2"	10.94
9500	2-1/2"	26.11
9501	3"	30.62
9502	4"	53.02

### Reducer Couplings - PVC (FIP)

Part #	Size	Price
9503	3/4" x 1/2"	2.95
9504	1" x 1/2"	4.11
9505	1" x 3/4"	2.63
9506	1-1/4" x 3/4"	7.95
9509	1-1/2" x 1"	14.34
9513	2" x 1-1/2"	15.65

## PVC 80 Fittings



### PVC Schedule 80 IPS Fittings

#### Tees - PVC (FIP)

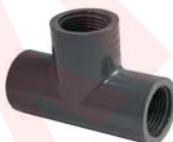

Part #	Size	Price
9573	1/4"	3.98
9575	1/2"	3.98
9576	3/4"	4.44
9577	1"	9.79
9578	1-1/4"	10.37
9579	1-1/2"	12.58
9580	2"	13.52
9581	2-1/2"	49.20

### 45° Elbows - PVC (FIP x FIP)



Part #	Size	Price
9562	1/4"	4.98
9563	3/8"	4.98
9564	1/2"	4.54
9565	3/4"	4.88
9566	1"	6.13
9567	1-1/4"	9.34
9568	1-1/2"	11.74
9569	2"	17.40
9570	2-1/2"	34.43
9571	3"	55.37
9572	4"	79.45

### Reducer Bushings - PVC (MIP x FIP)



Part #	Size	Price
9514	3/8" x 1/4"	4.46
9515	1/2" x 1/4"	4.46
9516	1/2" x 3/8"	4.46
9517	3/4" x 1/4"	3.32
9518	3/4" x 3/8"	3.32
9519	3/4" x 1/2"	2.74
9520	1" x 1/2"	4.29
9521	1" x 3/4"	4.29
9522	1-1/4" x 1/2"	4.55
9523	1-1/4" x 3/4"	4.55
9524	1-1/4" x 1"	4.55
9525	1-1/2" x 1/2"	5.39
9526	1-1/2" x 3/4"	5.39

Prices & specifications are subject to change.

We offer a variety of GREEN products such as flush valves, faucets, showerheads & more!



## PVC Schedule 80 Fittings



### Reducer Bushings - PVC (MIP x FIP) (Continued)

Part #	Size	Price
9527	1-1/2" x 1"	5.39
9528	1-1/2" x 1-1/4"	5.39
9529	2" x 1/2"	7.89
9530	2" x 3/4"	7.89
9531	2" x 1"	7.89
9532	2" x 1-1/4"	7.89
9533	2" x 1-1/2"	7.89
9535	2-1/2" x 2"	10.68
9538	3" x 2"	14.52
9540	4" x 2"	29.93
9541	4" x 3"	38.22

### Caps - PVC (FIP)



Part #	Size	Price
9584	1/4"	2.71
9585	3/8"	2.71
9586	1/2"	2.71
9587	3/4"	3.03
9588	1"	3.82
9589	1-1/4"	4.55
9590	1-1/2"	5.19
9591	2"	10.20
9593	3"	24.01
9594	4"	42.28

### Plugs - PVC (MIP)

Part #	Size	Price
9595	1/4"	2.34
9597	1/2"	2.09
9598	3/4"	2.17
9599	1"	2.65
9600	1-1/4"	3.91
9601	1-1/2"	4.75
9602	2"	4.88
9603	2-1/2"	13.62
9604	3"	15.89
9605	4"	30.93

### Flush Style Reducer Bushings - PVC (Spigot x FIP)



Part #	Size	Price
9299	3/8" x 1/4"	1.96
9300	1/2" x 1/4"	1.96
9301	1/2" x 3/8"	1.96
113803	3/4" x 1/4"	1.30
119665	3/4" x 1/2"	1.30
55391	1" x 1/2"	2.04
9302	1" x 3/4"	2.04
42318	2" x 3/4"	6.35
9305	3" x 1"	24.88

### PVC Schedule 80 Socket Fittings

#### Tees - PVC (Socket)

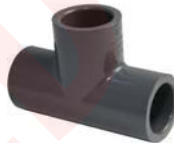

Part #	Size	Price
9365	1/4"	3.45
9366	3/8"	3.45
9367	1/2"	3.45
9368	3/4"	3.61
9369	1"	4.52
9370	1-1/4"	12.41
9371	1-1/2"	12.41
9372	2"	15.51
9373	2-1/2"	16.87
9374	3"	21.08
9375	4"	24.43
9376	6"	83.39
9377	8"	193.40
40071	10"	903.24

#### Reducing Tees - PVC (Socket)

Part #	Size	Price
242274	2" x 3/4"	14.84
42295	4" x 2"	31.08

### Reducing Tees - PVC (Socket) (Continued)

Part #	Size	Price
111406	4" x 3"	43.95
137326	6" x 4"	214.38

### 90° Elbows - PVC (Socket)



Part #	Size	Price
9341	1/2"	1.23
9342	3/4"	1.56
9343	1"	2.52
9344	1-1/4"	3.37
9345	1-1/2"	3.61
9346	2"	4.36
9347	2-1/2"	10.20
9348	3"	11.46
9349	4"	17.43
9350	6"	49.59
9351	8"	136.68

### 45° Elbows - PVC (Socket)



Part #	Size	Price
9353	3/8"	4.39
9354	1/2"	2.31
9355	3/4"	3.52
9356	1"	5.27
9357	1-1/4"	6.71
9358	1-1/2"	7.94
9359	2"	10.29
9360	2-1/2"	21.59
9361	3"	26.28
9362	4"	47.32
9363	6"	59.59
9364	8"	129.20



## PVC Schedule 80 Fittings



### Couplings - PVC (Socket)



Part #	Size	Price
9247	1/4"	3.54
9249	1/2"	2.21
9250	3/4"	3.00
9251	1"	3.08
9252	1-1/4"	4.69
9253	1-1/2"	5.05
9254	2"	5.43
9255	2-1/2"	13.35
9256	3"	15.33
9257	4"	19.19
9258	6"	41.30
9259	8"	56.21

### Reducer Couplings - PVC (Socket)

Part #	Size	Price
9260	3/4" x 1/2"	2.71
9261	1" x 1/2"	3.78
9262	1" x 3/4"	3.95
9267	1-1/2" x 1-1/4"	10.36
9269	2" x 1-1/2"	9.46

### Male Adapters - PVC (Socket x MIP)

Part #	Size	Price
9330	1/2"	2.59
9331	3/4"	2.85
9332	1"	4.93
9333	1-1/4"	5.77
9334	1-1/2"	8.29
9335	2"	11.98
9336	2-1/2"	13.62
9337	3"	15.12
9338	4"	26.89

### Female Adapters - PVC (Socket x FIP)

Part #	Size	Price
9317	1/4"	3.74
9318	3/8"	3.74
9319	1/2"	2.07

### Female Adapters - PVC (Socket x FIP) (Continued)

Part #	Size	Price
9320	3/4"	3.08
9321	1"	4.54
9322	1-1/4"	7.35
9323	1-1/2"	9.00
9324	2"	15.70
9325	2-1/2"	24.79
9326	3"	27.91
9327	4"	47.95

### Caps - PVC (Socket)



Part #	Size	Price
9378	1/4"	2.81
9379	3/8"	2.81
9380	1/2"	2.17
9381	3/4"	2.28
9382	1"	4.06
9383	1-1/4"	4.89
9384	1-1/2"	4.89
9385	2"	9.65
9386	2-1/2"	19.70
9387	3"	23.05
9388	4"	38.87
9389	6"	96.70

### Flush Style Reducer Bushings - PVC (Spigot x Socket)



Part #	Size	Price
9270	3/8" x 1/4"	1.96
9271	1/2" x 1/4"	1.96
9272	1/2" x 3/8"	1.96
9275	3/4" x 1/2"	0.72
9276	1" x 1/2"	2.04
9277	1" x 3/4"	2.04
9278	1-1/4" x 1/2"	3.20
9279	1-1/4" x 3/4"	3.20
9280	1-1/4" x 1"	3.20

### Flush Style Reducer Bushings - PVC (Spigot x Socket) (Continued)

Part #	Size	Price
9281	1-1/2" x 1/2"	4.36
9282	1-1/2" x 3/4"	4.36
9283	1-1/2" x 1"	4.36
9284	1-1/2" x 1-1/4"	4.36
9285	2" x 1/2"	6.22
9286	2" x 3/4"	6.22
9287	2" x 1"	6.22
9288	2" x 1-1/4"	6.22
9289	2" x 1-1/2"	6.22
9290	2-1/2" x 1-1/2"	10.79
9291	2-1/2" x 2"	10.79
9292	3" x 1-1/2"	17.11
9293	3" x 2"	17.11
9294	3" x 2-1/2"	17.11
9295	4" x 2"	23.70
9296	4" x 2-1/2"	23.70
9297	4" x 3"	23.70
9298	6" x 4"	32.95
48125	8" x 6"	80.15

### PVC Schedule 80 Unions Unions with Viton® O-Ring Seal - PVC 2000 (Socket)

- 235 psi Max internal pressure rating @ 73°F



Part #	Size	Price
9309	1/2"	4.54
9310	3/4"	5.76
9311	1"	6.57
9312	1-1/4"	13.05
9313	1-1/2"	14.78
9314	2"	20.04
9315	2-1/2"	45.37
9316	3"	37.30

Prices & specifications are subject to change.

Our state of the art pipe shop offers cutting, threading, grooving and make-ons up to 36in!



## PVC Schedule 80 Fittings

### Unions with BunaN O-Ring Seal - PVC (FIP)

- 235 psi Max internal pressure rating @ 73°F



Part #	Size	Price
9543	3/8"	5.26
9544	1/2"	5.26
9545	3/4"	7.36
9546	1"	9.79
9547	1-1/4"	18.67
9548	1-1/2"	23.12
9549	2"	35.57
9550	3"	90.23

### Flanges - Van Stone Style with Plastic Ring - PVC (Socket)

- 150 psi Max internal pressure rating @ 73°F

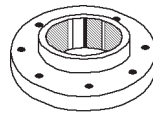

Part #	Size	Price
9400	1"	7.96
9401	1-1/4"	8.20
9402	1-1/2"	8.37
9403	2"	11.14
9404	2-1/2"	17.21
9405	3"	19.02
9406	4"	24.05
9407	6"	37.83
9408	8"	61.60

### Tank Adapters with Neoprene Gasket (Old Style) - PVC (Socket x FIP)

- 150 psi Max internal pressure rating @ 73°F

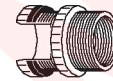

Part #	Size	Price
9617	1/2"	32.62
9618	3/4"	37.19
9619	1"	41.32
9620	1-1/4"	49.78
9621	1-1/2"	54.62
9622	2"	80.96
35950	3"	148.93

### 1-Piece Flanges -PVC (Socket)

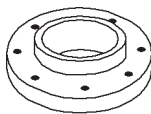

Part #	Size	Price
208036	1/2"	4.87

### Flanges - Van Stone Style with Plastic Solid Ring - PVC (Socket)

- 150 psi Max internal pressure rating @ 73°F

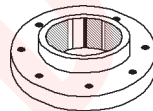

Part #	Size	Price
57286	12"	121.57

### Blind Flanges - PVC



Part #	Size	Price
9409	1/2"	9.38
9410	3/4"	11.18
9411	1"	15.27
9412	1-1/4"	18.73
9413	1-1/2"	18.73
9416	3"	55.02
9417	4"	68.54
136590	6"	83.29

### Flanges - Van Stone Style with Plastic Ring - PVC (FIP)

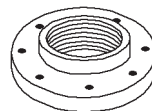

Part #	Size	Price
9606	1/2"	8.00
9607	3/4"	9.38
9608	1"	10.26
9609	1-1/4"	14.14
9611	2"	15.80
9612	2-1/2"	36.33
9614	4"	67.93



# Nipples

Sch 80  
Nipples



## PVC Schedule 80 PVC Nipples - 1/4"

Part#	Size	Price
9419	1/4" x Close	0.89
9420	1/4" x 1-1/2"	0.96
9421	1/4" x 2"	0.96
9422	1/4" x 2-1/2"	1.42
9423	1/4" x 3"	1.42
9424	1/4" x 3-1/2"	1.90
9425	1/4" x 4"	1.90
9426	1/4" x 4-1/2"	2.20
9427	1/4" x 5"	2.20
9428	1/4" x 5-1/2"	2.40
9429	1/4" x 6"	2.40

## PVC Nipples - 3/8"

Part#	Size	Price
9430	3/8" x Close	0.89
9431	3/8" x 1-1/2"	0.89
9432	3/8" x 2"	1.11
9433	3/8" x 2-1/2"	1.55
9434	3/8" x 3"	1.55
9435	3/8" x 3-1/2"	2.20
9436	3/8" x 4"	2.20
9437	3/8" x 4-1/2"	2.40
9438	3/8" x 5"	2.40
9439	3/8" x 5-1/2"	2.57
9440	3/8" x 6"	2.57

## PVC Nipples - 1/2"

Part#	Size	Price
9441	1/2" x Close	1.05
9442	1/2" x 1-1/2"	1.05
9443	1/2" x 2"	1.11
9444	1/2" x 3"	1.26
9445	1/2" x 4"	1.42
9446	1/2" x 5"	1.64
9447	1/2" x 6"	1.72

## PVC Nipples - 3/4"

Part#	Size	Price
9448	3/4" x Close	1.11
9449	3/4" x 2"	1.11
9450	3/4" x 3"	1.26
9451	3/4" x 4"	1.47
9452	3/4" x 5"	1.72

## PVC Nipples - 3/4" (Continued)

Part#	Size	Price
9453	3/4" x 6"	2.14

## PVC Nipples - 1"

Part#	Size	Price
9454	1" x Close	1.47
9455	1" x 2"	1.64
9456	1" x 3"	1.87
9457	1" x 4"	2.14
9458	1" x 5"	2.57
9459	1" x 6"	2.94

## PVC Nipples - 1-1/4"

Part#	Size	Price
9460	1-1/4" x Close	2.14
9461	1-1/4" x 2"	2.20
9462	1-1/4" x 3"	2.50
9463	1-1/4" x 4"	2.87
9464	1-1/4" x 5"	3.27
9465	1-1/4" x 6"	3.67

## PVC Nipples - 1-1/2"

Part#	Size	Price
9466	1-1/2" x Close	2.34
9467	1-1/2" x 2"	2.57
198020	1-1/2" x 2-1/2"	2.73
9468	1-1/2" x 3"	2.94
9469	1-1/2" x 4"	3.27
9470	1-1/2" x 5"	3.91
9471	1-1/2" x 6"	4.40

## PVC Nipples - 2"

Part#	Size	Price
9472	2" x Close	3.07
9473	2" x 2-1/2"	3.62
118087	2" x 3-1/2"	4.27
9475	2" x 4"	4.27
9476	2" x 5"	5.07
9477	2" x 6"	5.49

## PVC Nipples - 2-1/2"

Part#	Size	Price
9478	2-1/2" x Close	10.51
9480	2-1/2" x 4"	13.69
9482	2-1/2" x 6"	17.44

## PVC Nipples - 3"

Part#	Size	Price
9483	3" x Close	12.55
9485	3" x 4"	15.99
9487	3" x 6"	20.50

## PVC Nipples - 4"

Part#	Size	Price
9488	4" x Close	20.50
9491	4" x 6"	26.81

## CPVC Schedule 80

### CPVC Nipples - 1/2"

Part#	Size	Price
7328	1/2" x Close	2.60
7329	1/2" x 2"	3.10
7330	1/2" x 3"	3.54
7331	1/2" x 4"	4.14
7332	1/2" x 5"	4.65
7333	1/2" x 6"	5.25

### CPVC Nipples - 3/4"

Part#	Size	Price
7334	3/4" x Close	3.20
7335	3/4" x 2"	3.71
7336	3/4" x 3"	4.23
7337	3/4" x 4"	4.89
7338	3/4" x 5"	5.41
7339	3/4" x 6"	6.05

### CPVC Nipples - 1"

Part#	Size	Price
7340	1" x Close	3.88
7341	1" x 2"	3.10
7342	1" x 3"	5.25
7343	1" x 4"	6.04
7344	1" x 5"	6.81
7345	1" x 6"	7.91

### CPVC Nipples - 1-1/4"

Part#	Size	Price
7346	1-1/4" x Close	4.89
7347	1-1/4" x 2"	5.42
7348	1-1/4" x 3"	6.81
7349	1-1/4" x 4"	8.48
7350	1-1/4" x 5"	9.97

## CPVC Schedule 80 CPVC Nipples - 1-1/4" (Continued)

Part#	Size	Price
7351	1-1/4" x 6"	11.46

## CPVC Nipples - 1-1/2"

Part#	Size	Price
7352	1-1/2" x Close	5.42
7353	1-1/2" x 2"	6.05
7354	1-1/2" x 3"	7.52
7355	1-1/2" x 4"	9.09
7356	1-1/2" x 5"	10.61
7357	1-1/2" x 6"	12.09

## CPVC Nipples - 2"

Part#	Size	Price
7358	2" x Close	8.38
7359	2" x 3"	9.97
7360	2" x 4"	11.82
7361	2" x 5"	13.66
7362	2" x 6"	15.49

Prices & specifications are subject to change.

Metropolitan Pipe offers FREE DELIVERY in the Greater Boston area.



## Pipe



### CPVC CTS Pipe

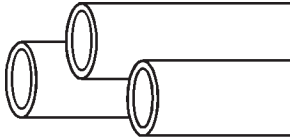

#### CPVC CTS Pipe - 10' Lengths

Part #	Size	Price
888757	1/2"	1.11
888260	3/4"	1.70
888262	1"	3.65
888264	1-1/4"	6.36
888265	1-1/2"	5.70
888266	2"	9.64

### CPVC Schedule 80 Industrial Fittings

#### Tees - CPVC Sch 80 (Socket)



Part #	Size	Price
7414	1/2"	5.23
7415	3/4"	5.33
7416	1"	6.53
7417	1-1/4"	13.77
7418	1-1/2"	15.77
7419	2"	17.55
37571	3"	44.68
110784	4"	59.46

#### 90° Elbows - CPVC Sch 80 (Socket)



Part #	Size	Price
7402	1/2"	2.24
7403	3/4"	2.85
7404	1"	4.53
7405	1-1/4"	9.79
7406	1-1/2"	10.92
7407	2"	13.18
36415	3"	34.36
44889	4"	61.88

#### 45° Elbows - CPVC Sch 80 (Socket)



Part #	Size	Price
7408	1/2"	2.74
7409	3/4"	3.95
7410	1"	6.27
7411	1-1/4"	12.32
7412	1-1/2"	12.65
7413	2"	14.19
36407	3"	37.25
46748	4"	51.12

#### Couplings - CPVC Sch 80 (Socket)



Part #	Size	Price
7363	1/2"	2.36
7364	3/4"	3.30
7365	1"	4.44
7366	1-1/4"	6.65
7367	1-1/2"	8.37
7368	2"	9.73
48299	2-1/2"	31.59
33620	3"	23.52
46749	4"	30.82

#### Couplings - CPVC Sch 80 (FIP)



Part #	Size	Price
117774	1/2"	6.27
118058	3/4"	10.13
198165	1"	16.26

#### Female Adapters - CPVC Sch 80 (Socket x FIP)

Part #	Size	Price
7396	1/2"	3.82
7397	3/4"	4.02
7398	1"	9.31
7399	1-1/4"	9.53

#### Female Adapters - CPVC Sch 80 (Socket x FIP) (Continued)

Part #	Size	Price
7400	1-1/2"	11.10
7401	2"	19.12
138500	3"	75.24

#### Male Adapters - CPVC Sch 80 (Socket x MIP)

Part #	Size	Price
7390	1/2"	3.05
7391	3/4"	3.72
7392	1"	6.26
7393	1-1/4"	9.23
7394	1-1/2"	12.47
7395	2"	16.92
37568	3"	61.97
43173	4"	104.77

#### Flush Style Reducer Bushings - CPVC Sch 80 (Spigot x Socket)



Part #	Size	Price
7369	3/4" x 1/2"	2.52
7370	1" x 1/2"	3.91
7371	1" x 3/4"	3.91
7372	1-1/4" x 1/2"	14.67
7373	1-1/4" x 3/4"	10.37
7374	1-1/4" x 1"	14.67
7375	1-1/2" x 1/2"	16.58
7376	1-1/2" x 3/4"	11.73
7377	1-1/2" x 1"	11.73
7378	1-1/2" x 1-1/4"	16.58
7379	2" x 1/2"	15.14
7380	2" x 3/4"	15.14
7381	2" x 1"	15.14
7383	2" x 1-1/2"	15.14



## CPVC Fittings

### Caps - CPVC Sch 80 (Socket)



Part #	Size	Price
7420	1/2"	3.67
7421	3/4"	5.23
7422	1"	9.26
7423	1-1/4"	10.13
7424	1-1/2"	10.13
36409	3"	39.42

### Blind Flanges - CPVC Sch 80

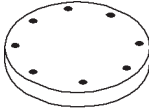

Part #	Size	Price
118077	4"	120.55
166411	6"	202.22

### Flanges - Van Stone Style with Plastic Ring - Copper (Socket)

- 150 psi Max internal pressure rating @ 73°F

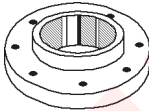

Part #	Size	Price
7426	1"	11.17
7429	2"	18.33
37577	3"	39.75
110781	4"	53.68
133527	6"	91.46
111615	8"	275.19

### CPVC Schedule 80 Unions Unions with Viton® O-Ring Seal - Copper (Socket)



Part #	Size	Price
7384	1/2"	10.12
7385	3/4"	10.57

### CPVC Schedule 80 Unions (Continued)

#### Unions with Viton® O-Ring Seal - Copper (Socket)

Part #	Size	Price
7386	1"	12.69
7387	1-1/4"	25.67
7388	1-1/2"	26.14
7389	2"	43.33



### FlowGuard Gold® CPVC Fittings

- CTS - Copper tube size system
- Chlorinated polyvinyl chloride (CPVC)
- Used for hot and cold domestic water distribution where the operating temperature will not exceed 180°F at 100psi
- Conforms to safety requirements of ANSI/NSF Standard 61 (drinking water components, health effects)
- Highly resistant to corrosion

#### Couplings (Slip x Slip)



Part #	Size	Price
863863	1/2"	0.62
863862	3/4"	0.77
880293	1"	3.44
880294	1-1/4"	4.70

#### Female Adapter (Brass FPT x CTS HUB)



Part #	Size	Price
880269	1/2"	9.00
888279	3/4"	12.24
888277	1"	23.24
888276	1-1/4"	71.20

### Male Adapters (Brass MPT x CTS HUB)

Part #	Description	Price
888295	1/2"	7.30
888298	3/4"	12.24
888296	1"	23.24
888294	1-1/4"	71.20

### Reducer Bushing (Slip x Socket)

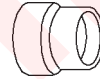

Part #	Size	Price
880277	3/4" x 1/2"	0.93
880278	1" x 1/2"	3.04
880279	1" x 3/4"	3.04

### Reducer Bushing (Slip x Slip)

Part #	Size	Price
880280	1-1/4" x 1/2"	4.36
880281	1-1/4" x 3/4"	3.94
880282	1-1/4" x 1"	3.44

### Cap (Slip)



Part #	Size	Price
863866	1/2"	0.64
888303	3/4"	0.86
888301	1"	3.12
888300	1-1/4"	4.42

### 90° Elbow (Slip x Slip)



Part #	Size	Price
863868	1/2"	0.71
863867	3/4"	1.16
888306	1"	3.39
888305	1-1/4"	6.75

Prices & specifications are subject to change.

Metropolitan Pipe offers Vendor Managed Inventory - never run out of that part again!



## CPVC Fittings



### Street 90° Elbow (Spigot x Slip)



Part #	Size	Price
863871	1/2"	0.88
888635	3/4"	1.38
888311	1"	6.29

### CPVC 90° Drop Ear Elbows (Slip x Slip)



Part #	Size	Price
888309	1/2"	2.22

### 45° Elbow (Slip x Slip)



Part #	Size	Price
242295	1/2"	0.95
863872	3/4"	1.64
888314	1"	3.93
888313	1-1/4"	8.79

### Street 45° Elbow (Spigot x Slip)

Part #	Size	Price
888316	1/2"	1.89
888318	3/4"	2.68
888317	1"	7.70

### Tee (Slip x Slip x Slip)



Part #	Size	Price
888637	1/2"	0.96
888636	3/4"	1.70
888320	1"	8.87

### FlowGuard Gold® CPVC Fittings (Continued) Tee (Slip x Slip x Slip)

Part #	Size	Price
880274	1-1/4"	13.62

### Reducing Tee (Slip x Slip x Slip)



Part #	Size	Price
888319	1/2" x 3/4"	3.32
888322	3/4" x 1/2" x 1/2"	1.75
888324	3/4" x 1/2"	1.85
880303	1" x 1/2"	10.08
880304	1" x 3/4"	9.62

Pipe, Fittings, Hardware







## Cast Iron Pipe

### Cast Iron No-Hub Soil Pipe

#### No-Hub Soil Pipe - 10' Lengths - Cast Iron

Part #	Size	Price
9716	2" x 10'	63.66
9717	3" x 10'	87.82
9718	4" x 10'	114.04
9719	5" x 10'	164.43
9720	6" x 10'	196.06
9721	8" x 10'	305.40
9722	10" x 10'	518.91
202163	12" x 10'	753.82
202213	15" x 10'	1101.60

### Cast Iron Service-Weight Soil Pipe



#### Single-Hub Soil Pipe - 10' Lengths - Cast Iron Service-Weight

Part #	Size	Price
9770	2" x 10'	70.23
9771	3" x 10'	96.91
9772	4" x 10'	125.96
9773	5" x 10'	177.70
9774	6" x 10'	216.42
9775	8" x 10'	337.03
9776	10" x 10'	560.92
9777	12" x 10'	814.83
9778	15" x 10'	1190.84

#### Single-Hub Soil Pipe - 5' Lengths - Cast Iron Service-Weight

Part #	Size	Price
9752	2" x 5'	69.39
9753	3" x 5'	73.26
9754	4" x 5'	85.05
9755	5" x 5'	137.82
9756	6" x 5'	160.82
9757	8" x 5'	234.52
9758	10" x 5'	356.36
9759	12" x 5'	470.33
9760	15" x 5'	734.17

#### Single-Hub Soil Pipe - 30" Lengths - Cast Iron Service-Weight

Part #	Size	Price
197137	8" x 30"	128.54
197138	10" x 30"	160.43
197139	12" x 30"	308.04

#### Double-Hub Soil Pipe - 5' Lengths - Cast Iron Service-Weight



Part #	Size	Price
9761	2" x 5'	73.39
9762	3" x 5'	81.83
9763	4" x 5'	93.17
9764	5" x 5'	143.81
9765	6" x 5'	169.90

#### Double-Hub Soil Pipe - 30" Lengths - Cast Iron Service-Weight

Part #	Size	Price
10418	2" x 30"	57.28
10419	3" x 30"	68.36
10420	4" x 30"	80.09

## No-Hub Fittings



#### Cast Iron No-Hub Soil Fittings

##### No-Hub Soil 1/4 Bends - Cast Iron

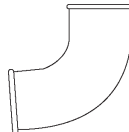

Part #	Size	Price
9999	1-1/2"	8.64
10000	2"	9.35
10001	3"	13.08
10002	4"	19.40
10003	5"	43.56

#### No-Hub Soil 1/4 Bends - Cast Iron (Continued)

Part #	Size	Price
10004	6"	46.84
10005	8"	131.70

#### No-Hub Soil Extended 1/4 Bends

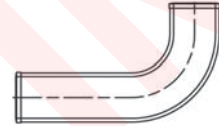

Part #	Size	Price
10021	2" x 12"	26.10
10022	3" x 12"	44.85
10023	4" x 12"	66.56

#### No-Hub Soil Short Sweep 1/4 Bends - Cast Iron

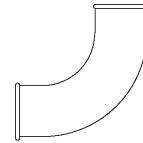

Part #	Size	Price
10006	2"	13.02
10007	3"	17.08
10008	4"	30.22
45068	5"	53.09
10009	6"	55.80
10010	8"	144.32
10011	10"	263.26
202164	12"	822.31
202216	15"	1077.12

#### No-Hub Soil Long Sweep 1/4 Bends - Cast Iron

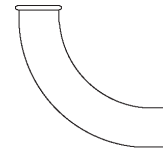

Part #	Size	Price
10013	2"	20.49
10014	3"	24.87
10015	4"	39.56
10016	5"	71.46
10017	6"	87.18

Prices & specifications are subject to change.

Our faucet parts counter is one of the largest in the Boston area with thousands of parts in stock!



## Cast Iron Fittings



### No-Hub Soil 1/5 Bends - Cast Iron

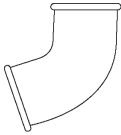

Part #	Size	Price
10026	4"	33.83

### No-Hub Soil 1/6 Bends - Cast Iron

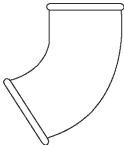

Part #	Size	Price
10027	2"	9.93
10028	3"	12.76
10029	4"	17.08

### No-Hub Soil 1/8 Bends - Cast Iron

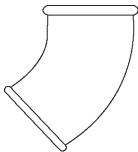

Part #	Size	Price
10031	2"	8.06
10032	3"	10.83
10033	4"	14.18
10034	5"	29.58
10035	6"	31.45
10036	8"	90.72
10037	10"	172.48
202167	12"	348.63
202214	15"	695.58

### No-Hub Soil Long 1/8 Bends - Cast Iron

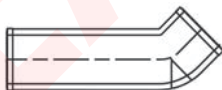

Part #	Size	Price
10038	2" x 12"	25.26
10039	3" x 12"	38.66
10040	4" x 12"	62.76

### No-Hub Soil 1/16 Bends - Cast Iron



Part #	Size	Price
92171	1-1/2"	6.19
10041	2"	8.25
10042	3"	9.60
10043	4"	12.70
10044	5"	28.16
10045	6"	34.09
10046	8"	54.25

### No-Hub Soil Sanitary Tees - Cast Iron

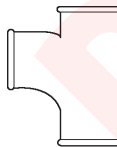

Part #	Size	Price
10048	2"	12.89
10049	3"	15.98
10050	4"	30.16
10051	5"	70.62
10052	6"	72.04
10053	8"	292.00
10054	2" x 1-1/2"	13.08
10055	3" x 1-1/2"	15.34
10056	3" x 2"	14.11
10057	4" x 2"	20.30
10058	4" x 3"	23.26
10059	5" x 2"	50.52
10060	5" x 3"	53.09
10061	5" x 4"	54.58
10062	6" x 2"	52.13
10063	6" x 3"	53.09
10064	6" x 4"	54.58
10065	6" x 5"	85.69
158571	8" x 4"	222.30
10066	8" x 6"	168.36

### No-Hub Soil Sanitary Tees with 2" Side Opening - Cast Iron (Estabrook)

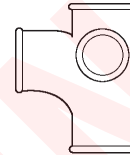

Part #	Size	Price
75867	4X4X4X2 (LH)	74.55

### No-Hub Soil Sanitary Tapped Tees - Cast Iron

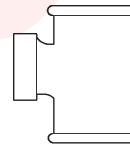

Part #	Size	Price
10074	2" x 1-1/2"	14.11
10075	2" x 2"	16.24
10077	3" x 1-1/2"	19.27
10078	3" x 2"	22.62
10079	3" x 3"	41.63
10080	4" x 1-1/2"	20.04
10081	4" x 2"	22.75
10082	4" x 3"	30.42

### No-Hub Soil Wyes - Cast Iron

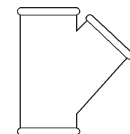

Part #	Size	Price
10090	2"	11.99
10091	3"	17.47
10092	4"	27.84
10093	5"	66.17
10094	6"	74.23
10095	8"	174.93
10096	10"	388.25
202165	12"	764.58
202218	15"	1710.45
10097	3" x 2"	12.89
10098	4" x 2"	18.62
10099	4" x 3"	24.23
10100	5" x 2"	41.05
10101	5" x 3"	57.60
10102	5" x 4"	59.28
10103	6" x 2"	45.68



## Cast Iron Fittings

### No-Hub Fittings

#### No-Hub Soil Wyes - Cast Iron (Continued)

Part #	Size	Price
10104	6" x 3"	57.60
10105	6" x 4"	59.28
10106	6" x 5"	71.91
10108	8" x 4"	101.87
10109	8" x 5"	123.45
10110	8" x 6"	125.38
10111	10" x 4"	269.19
10112	10" x 6"	281.82
10113	10" x 8"	338.19

#### No-Hub Soil Double Wyes - Cast Iron

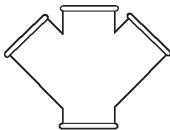

Part #	Size	Price
10114	2"	19.01
10115	3"	34.99
10116	4"	71.26
57017	8"	293.22
10118	3" x 2"	29.58
10119	4" x 2"	39.44
10120	4" x 3"	44.59
10121	5" x 4"	94.59
10122	6" x 4"	101.67

#### No-Hub Soil Upright Wyes - Cast Iron



Part #	Size	Price
10128	2"	21.07
10129	3"	28.74
10130	4"	76.10
10131	3" x 2"	20.56
10132	4" x 2"	28.87
10133	4" x 3"	38.47

#### No-Hub Soil Combination Wye & 45° Elbow - Cast Iron

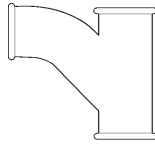

Part #	Size	Price
10134	2"	13.66
10135	3"	21.52
10136	4"	41.43
10138	6"	113.79
10139	3" x 2"	17.08
10140	4" x 2"	22.30
10141	4" x 3"	31.70
174816	5" x 3"	102.20
10142	5" x 4"	78.16
110547	6" x 3"	66.11
10143	6" x 4"	66.82

#### No-Hub Soil Double Combination Wye & 45° Elbow - Cast Iron

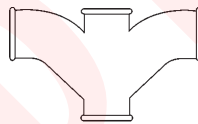

Part #	Size	Price
111142	3"	50.07
55592	4" x 3"	65.21

#### No-Hub Tapped Wye - Cast Iron

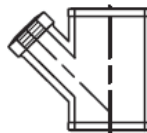

Part #	Size	Price
10123	2" x 1-1/2"	27.06
123153	2" x 2"	29.32
10124	3" x 1-1/2"	30.42
10125	3" x 2"	34.47
10127	4" x 2"	37.63

#### No-Hub Tapped Double Wye - Cast Iron

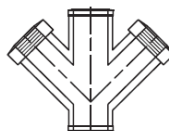

Part #	Size	Price
174802	2" x 1-1/2"	53.74

#### No-Hub Soil Sanitary Crosses - Cast Iron

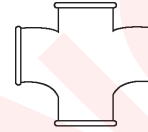

Part #	Size	Price
10067	2"	22.04
10068	3"	34.02
10069	4"	64.37
10070	3" x 2"	30.35
10071	4" x 2"	43.30
10072	4" x 3"	52.32
50622	6" x 4"	93.04
174814	8" x 4"	217.97

#### No-Hub Soil Sanitary Tap Crosses - Cast Iron (Double Tap TY)

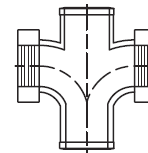

Part #	Size	Price
10084	2"	16.24
10083	2" x 1-1/2"	14.11
10085	3" x 1-1/2"	19.27
10086	3" x 2"	22.62
10087	4" x 1-1/2"	20.04
10088	4" x 2"	22.75

#### No-Hub Soil Test Tees with Type A Brass Plug - Cast Iron

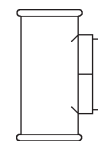

Part #	Size	Price
10156	2" - 2"	21.85
10157	3" - 3"	36.47
10158	4" - 4"	61.86
10159	5" - 5"	113.79
10160	6" - 6"	166.30
10161	8" - 8"	317.38
45070	10" - 10"	954.10

Prices & specifications are subject to change.

Our office hours are 7am to 4:30pm and counter hours 6am to 4:30pm Monday through Friday.



## Cast Iron Fittings



### No-Hub Soil Short Reducers - Cast Iron

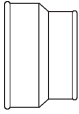

Part #	Size	Price
9976	3" x 2"	6.64
9977	4" x 2"	10.25
9978	4" x 3"	10.25
9980	5" x 3"	19.01
9981	5" x 4"	19.72
9982	6" x 2"	28.16
9983	6" x 3"	27.52
9984	6" x 4"	27.52
9985	6" x 5"	28.16
9987	8" x 3"	32.86
9988	8" x 4"	42.40
9989	8" x 5"	47.94
9990	8" x 6"	47.17
9991	10" x 4"	83.38
9992	10" x 6"	88.08
9993	10" x 8"	103.35
202166	12" x 4"	172.42
202221	12" x 6"	184.72
202171	12" x 8"	189.88
202170	12" x 10"	193.10
202226	15" x 4"	360.55
202225	15" x 6"	340.45
202224	15" x 8"	391.73
202223	15" x 10"	405.90
202222	15" x 12"	410.80

### No-Hub End Cleanout (with Southern Code Plug)



Part #	Size	Plug	Price
10163	2"	1-1/2"	18.95
10164	3"	2-1/2"	24.27
10165	4"	3-1/2"	33.33
10166	5"	4"	52.28
10167	6"	5"	69.58
10168	8"	6"	153.09

### No-Hub Soil Blind Plugs - Cast Iron



Part #	Size	Price
10149	1-1/2"	4.64
10150	2"	4.64
10151	3"	6.77
10152	4"	10.70
10153	5"	19.72
10154	6"	20.56
10155	8"	54.70
92784	10"	80.67
202227	12"	127.77
227745	15"	219.45

### No-Hub Soil P-Traps - Cast Iron

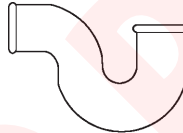

Part #	Size	Price
10144	2"	13.66
10145	3"	29.96
10146	4"	53.09
10147	6"	128.80

### No-Hub Soil P-Traps with 1/2" Heel Tapping - Cast Iron



Part #	Size	Price
922438	2"	30.54
940186	3"	49.16
113349	4"	86.15

### No-Hub Soil Closet Flanges (Slot & Notch) - Cast Iron

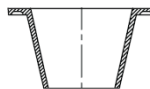

Part #	Size	Price
9796	4" x 3"-3-1/2"	19.33
9795	4"-4"	22.62

### Tapped Adapters - Cast Iron



Part #	Size	Price
9997	2" x 1-1/2"	10.76
9998	2" x 2"	10.76

### Cast Iron Service-Weight Soil Fittings

#### Service-Weight Soil 1/4 Bends - Cast Iron Single-Hub

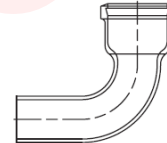

Part #	Size	Price
10453	2"	16.76
10454	3"	22.36
10455	4"	34.99
10456	5"	48.84
10457	6"	60.89
10458	8"	183.43
10459	10"	268.09
10460	12"	363.19

#### Service-Weight Soil Long 1/4 Bends - Cast Iron Single-Hub



Part #	Size	Price
10462	2" x 12"	43.62
10463	3" x 12"	53.16
10464	4" x 12"	49.68
10467	4" x 18"	70.17

#### Service-Weight Soil 1/6 Bends - Cast Iron Single-Hub

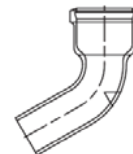

Part #	Size	Price
10506	2"	21.14
10507	3"	27.90
10508	4"	33.44



## Cast Iron Fittings

**No-Hub  
 Fittings**

### Service-Weight Soil 1/6 Bends - Cast Iron Single-Hub (Continued)

Part #	Size	Price
10509	6"	76.16

### Service-Weight Soil 1/8 Bends - Cast Iron Single-Hub

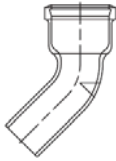

Part #	Size	Price
10471	2"	11.92
10472	3"	18.69
10473	4"	27.39
10474	5"	37.82
10475	6"	46.26
10476	8"	138.20
10477	10"	198.77
10478	12"	376.98
10479	15"	815.50

### Service-Weight Soil Long 1/8 Bends - Cast Iron Single-Hub



Part #	Size	Price
10480	2" - 12"	49.81
10481	3" - 12"	55.99
10482	4" - 12"	55.03

### Service-Weight Soil 1/16 Bend - Cast Iron Single-Hub



Part #	Size	Price
10489	2"	13.53
10490	3"	20.56
10491	4"	23.91
10492	5"	39.37
10493	6"	40.40
10494	8"	141.75

### Service-Weight Soil Short Sweep Bends - Cast Iron Single-Hub

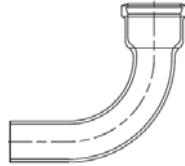

Part #	Size	Price
41801	2"	16.43
41802	3"	29.26
41803	4"	44.78
41804	5"	75.45
41805	6"	90.85
136572	10"	404.62

### Service-Weight Soil Long Sweep Bends - Cast Iron Single-Hub



Part #	Size	Price
10498	2"	25.39
10499	3"	36.21
10500	4"	53.22
10501	5"	88.01
10502	6"	107.02
10503	8"	242.13
47438	10"	409.38

### Service-Weight Soil Wyes - Cast Iron Single-Hub

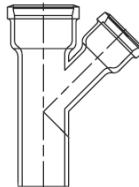

Part #	Size	Price
10575	2"	21.33
10576	3"	39.56
10577	4"	52.97
10578	5"	93.68
10579	6"	121.71
10580	8"	297.47
10581	10"	480.71
10582	12"	10889.27
10559	3" x 2"	30.67
10560	4" x 2"	41.17

### Service-Weight Soil Wyes - Cast Iron Single-Hub (Continued)

Part #	Size	Price
10561	4" x 3"	45.36
10562	5" x 2"	69.01
10563	5" x 3"	73.84
10564	5" x 4"	72.10
10565	6" x 2"	81.18
10566	6" x 3"	82.86
10567	6" x 4"	82.09
10568	6" x 5"	115.07
10570	8" x 3"	141.10
10571	8" x 4"	156.57
10572	8" x 5"	184.98
10569	8" x 6"	194.45
10584	10" x 4"	268.09
10585	10" x 5"	296.25
10586	10" x 6"	292.32
10587	10" x 8"	401.27
10574	12" x 4"	453.20
10588	12" x 5"	481.61
10589	12" x 6"	466.98
10590	12" x 8"	560.40
10591	12" x 10"	894.79
10594	15" x 10"	1584.05
10595	15" x 12"	1704.27

### Service-Weight Soil Double Wyes - Cast Iron

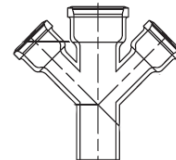

Part #	Size	Price
10596	2"	51.16
10597	3"	64.76
10598	4"	84.79
124383	6"	217.97
10601	4" x 2"	66.56
10602	4" x 3"	70.17

Prices & specifications are subject to change.

You can check stock availability, pricing and place orders online at [www.MetPipe.com](http://www.MetPipe.com).



## Cast Iron Fittings

### Service-Weight Soil Combination Wye & 45° Elbow (Long Turn Pattern) - Cast Iron

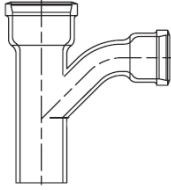

Part #	Size	Price
10608	2"	29.26
10609	3"	44.53
10610	4"	61.34
119308	6"	147.22
10612	3" x 2"	33.64
10613	4" x 2"	45.36
10614	4" x 3"	53.29
41813	6" x 4"	106.12

### Service-Weight Soil Sanitary Tee - Cast Iron

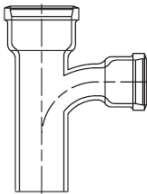

Part #	Size	Price
10525	2"	23.39
10526	3"	37.82
10527	4"	46.26
10528	5"	92.20
10529	6"	104.51
10530	8"	276.79
10531	10"	507.77
10534	3" x 2"	32.48
10535	4" x 2"	39.56
10536	4" x 3"	42.46
10537	5" x 4"	86.79
10538	6" x 3"	84.73
10539	6" x 4"	118.17
10542	8" x 4"	176.99

### Service-Weight Soil Sanitary Tee w/Side Tap - Cast Iron

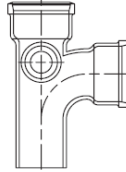

Part #	Size	Price
174727	4" w/2" LH	92.72
174799	4" w/2" RH	92.72

### Service-Weight Soil Sanitary Tapped Tee - Cast Iron

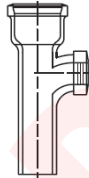

Part #	Size	Price
10550	2"	31.38
10549	2" x 1-1/2"	32.99
10551	3" x 1-1/2"	38.28
10552	3" x 2"	35.12
10553	4" x 1-1/2"	47.94
43604	2" x 2" x 18"	77.71

### Service-Weight Soil Sanitary Crosses - Cast Iron

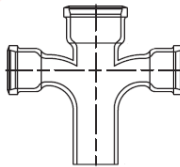

Part #	Size	Price
10544	2"	50.13
10545	3"	60.83
10546	4"	77.25
57354	3" x 2"	60.83
10547	4" x 2"	60.25
10548	4" x 3"	64.05

### Service-Weight Soil Sanitary Tapped Crosses - Cast Iron

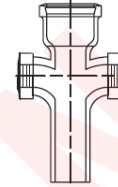

Part #	Size	Price
10558	2"	39.18
124381	3" x 1-1/2"	57.64
57041	3" x 2"	52.84
10557	4" x 2"	65.08

### Service-Weight Soil P-Traps - Cast Iron

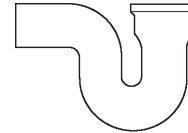

Part #	Size	Price
10627	2"	26.68
10628	3"	39.82
10629	4"	57.41
10630	5"	99.03
10631	6"	176.99

### Service-Weight Washington Test Tee with Southern Raised Head Brass Plug Installed - Cast Iron

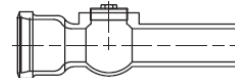

Part #	Size	Price
9830	2" - 2"	51.74
9832	4" - 4"	124.93
9833	5" - 5"	165.72
9834	6" - 6"	255.92

### Service-Weight Cleanout Ferrules with Southern Raised Head Brass Plug Installed - Cast Iron

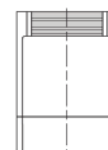

Part #	Size	Price
9844	2" - 1-1/2"	20.88



## Cast Iron Fittings

No-Hub  
Fittings

### Service-Weight Cleanout Ferrules with Southern Raised Head Brass Plug Installed - Cast Iron (Continued)

Part #	Size	Price
9845	3" - 2-1/2"	31.32
9846	4" - 3-1/2"	36.47
9847	5" - 4"	55.09
9848	6" - 5"	85.24
9849	8" - 6"	129.31
9850	10" - 6"	213.01
9851	12" - 6"	255.66

### Service-Weight Reducer - Cast Iron

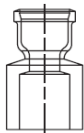

Part #	Size	Price
10421	3" x 2"	16.43
10422	4" x 2"	18.75
10423	4" x 3"	21.33
10424	5" x 3"	47.10
10425	5" x 4"	27.45
10426	6" x 4"	43.04
10427	6" x 5"	46.26
10429	8" x 4"	71.71
10430	8" x 5"	74.42
10431	8" x 6"	73.71
10432	10" x 4"	108.12
10433	10" x 5"	124.48
10434	10" x 6"	120.94
10435	10" x 8"	121.13
10436	12" x 4"	176.02
10438	12" x 6"	188.72
10439	12" x 8"	193.93
10440	12" x 10"	197.03
10441	15" x 6"	367.96
10442	15" x 8"	577.20

### Service-Weight Pipe Plug - Cast Iron



Part #	Size	Price
10618	2"	8.38

Prices & specifications are subject to change.

We offer a variety of GREEN products such as flush valves, faucets, showerheads & more!

### Service-Weight Pipe Plug - Cast Iron (Continued)

Part #	Size	Price
10619	3"	11.99
10620	4"	14.63
10621	5"	28.35
10622	6"	27.45

### X-Heavy Weight Cast Iron Soil Fittings

#### X-Heavy Closet Flanges - Cast Iron



Part #	Size	Price
55345	4" x 2-1/2"	13.43
55504	4" x 4"	20.94
55506	4" x 6"	34.14

#### Push-On Closet Flange - Specialty Cast Iron



Part #	Size	Price
169176	4" x 4"	32.57

#### Offset Closet Flange (to Offset 1") - Specialty Cast Iron

- Fits over 4" pipe for caulk joints



Part #	Size	Price
9794	4" x 2"	28.84
9793	4" x 2-1/2"	47.62

### Greensboro Reducing Closet Flange - Specialty Cast Iron

- Use to caulk over 3" pipe or use coupling to 4" no hub pipe

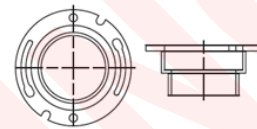

Part #	Size	Price
9792	4" x 3" x 3"	21.20

#### Notched and Slotted Closet Flange - Specialty Cast Iron

- Fits over 4" pipe for caulk joints

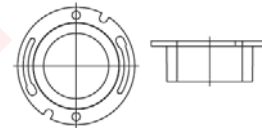

Part #	Size	Price
9789	4" x 1-1/2"	13.11



## Plugs, Valves, Couplings

### Cleanout Plugs

Southern Code Brass - Raised Head



Part #	Size	Price
9860	1-1/2"	7.80
9861	2"	10.16
9862	2-1/2"	11.41
9863	3"	17.86
9864	3-1/2"	28.29
9865	4"	31.72
9867	5"	47.46
9868	6"	89.73

### Countersunk

Part #	Size	Price
9869	1-1/2"	10.60
9870	2"	14.65
9871	2-1/2"	17.57
9872	3"	21.91
9873	3-1/2"	30.65
9874	4"	42.15
9876	5"	59.00
9877	6"	115.44
9878	8"	169.06

### Backwater Valves

Cast Iron Service Weight Backwater Valves

- Reduces backflow in drainage system
- All neoprene gaskets
- 300 Series stainless bolts and washers
- Repairable in service

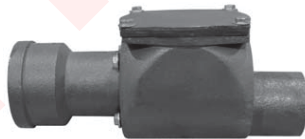

Part #	Size	Hub	Price
9822	3" x 10-3/4"	5-1/8"	61.28
9823	4" x 11-3/4"	6-1/2"	71.19

### Cast Iron No-Hub Backwater Valves

- Reduces backflow in drainage system
- All neoprene gaskets
- 300 Series stainless bolts and washers
- Repairable in service



Part #	Size	Length	Price
9826	2"	10-3/4"	71.35
9827	3"	11-3/4"	97.35
9828	4"	12-3/4"	104.61
9829	6"	14-1/2"	171.33

### No-Hub Couplings

Old-Style CISPI No-Hub Couplings

- Conforms to CISPI 310



Part #	Mfg #	Size	Price
9704	C150C	1-1/2"	6.16
9706	C200C	2"	6.16
9707	C300C	3"	7.36
9708	C400C	4"	8.70
9709	C500C	5"	21.15
9710	C600C	6"	22.04
9711	C800C	8"	41.59
9712	C1000C	10"	54.90
205492	C1200HW	12"	92.71
215452	C1500HW	15"	129.60

### Mission Heavyweight No-Hub Couplings

- For heavy-duty installations
- Multiple bands attached to heavy duty, corrugated 304 Series stainless steel shield over a molded one-piece elastomer sealing sleeve
- 1500 PSI min.



Part #	Mfg #	Size	Price
930549	C150HW	1-1/2"	8.94
235176	C200HW	2"	8.08
235175	C300HW	3"	9.35
235174	C400HW	4"	10.84
930550	C500HW	5"	22.24
930551	C600HW	6"	25.64
930552	C800HW	8"	51.66

Prices & specifications are subject to change.





## Couplings

### No-Hub Couplings (Continued) Mission Heavyweight No-Hub Couplings

Part #	Mfg #	Size	Price
930553	C1000HW	10"	67.25

### Husky SD 4000 Super Duty No-Hub Couplings

- A Super-Duty stainless steel coupling for joining No-Hub cast iron soil pipe and fittings
- Extra width for lateral support
- Additional sealing clamps for better load distribution and a more positive seal.
- 304 stainless steel heavy duty construction. Shield color coated orange.
- Meets ASTM C-1540 standard specification for Heavy Duty shielded couplings.



Part #	Mfg #	Size	Price
9683	4002	1-1/2"	10.14
9684	4006	2"	10.82
9685	4008	3"	12.47
9686	4010	4"	14.54
9687	4012	5"	29.85
9688	4014	6"	35.34
9689	4016	8"	69.97
9690	4017	10"	89.98

### Service-Weight Gaskets



Part #	Mfg #	Size	Price
9893	3002	2"	2.84
9894	3003	3"	3.74
9895	3004	4"	4.73
9896	3005	5"	7.30
9897	3006	6"	7.56
9898	3008	8"	16.67
9899	3010	10"	29.04
9900	3012	12"	32.07
9901	3015	15"	38.33

IPS Size Chart (Shaded Row: Wall Thickness, White Row: Weight#)

Pipe Size	O.D. (In)	STD	XH	XXH	10	20	30	40	60	80	100	120	140	160
1/2	0.840	100	147	294				109	147					188
3/4	1.050	85	109	171				85	109					131
1	1.315	113	154	308				113	154					219
1-1/4	1.660	146	200	400				146	200					281
1-1/2	1.900	168	237	474				168	237					325
2	2.375	218	300	600				218	300					438
2-1/2	2.875	272	370	740				272	370					531
3	3.500	350	500	1000				350	500					635
3-1/2	4.125	425	600	1200				425	600					739
4	4.500	450	675	1350				450	675					843
5	5.563	556	834	1668				556	834					1000
6	6.625	662	993	1986				662	993					1157
8	8.625	862	1293	2586				862	1293					1511
10	10.750	1075	1612	3224				1075	1612					1871
12	12.750	1275	1912	3824				1275	1912					2237
14	14.750	1475	2212	4424				1475	2212					2603
16	16.750	1675	2512	5024				1675	2512					2969
18	18.750	1875	2812	5624				1875	2812					3335
20	20.750	2075	3112	6224				2075	3112					3701
24	24.750	2475	3712	7424				2475	3712					4429
28	28.750	2875	4312	8624				2875	4312					5157
30	30.000	3000	4500	9000				3000	4500					5400
36	36.000	3600	5400	10800				3600	5400					6480
42	42.000	4200	6300	12600				4200	6300					7560
48	48.000	4800	7200	14400				4800	7200					8640

**Spec Sheets**  
 Need exact sizes and other specs? See pages 634-658!



## Fusion Piping



### Aquatherm PPR Fusion Piping System

- For use with: Hydronics, Domestic Water, Compressed Air, High Purity, Fire Protection, Food Grade
- MA Approved
- Earns LEED Credits
- Environmentally Friendly

#### Pipe

#### Greenpipe® Faser-composite Pipe SDR 7.4



- For high temperature, moderate pressure systems, particularly domestic hot water systems.

Part#	Mfg#	Size	Price
949780	0670708	1/2" x 13'	1.04
949781	0670710	3/4" x 13'	1.56
949782	0670712	1" x 13'	2.58
949783	0670714	1-1/4" x 13'	3.89
949784	0670716	1-1/2" x 13'	6.36
949785	0670718	2" x 13'	9.69
949786	0670720	2-1/2" x 13'	14.11
949787	0670722	3" x 13'	19.69
949788	0670726	4" x 13'	36.02
949789	0670730	6" x 19'	42.51

#### Greenpipe® Faser-composite Pipe SDR 11



- Potable water, preferably domestic cold. Low pressure installations, such as well-casings, food processing, etc.

Part#	Mfg#	Size	Price
949790	0610208	1/2" x 13'	0.72
949791	0610210	3/4" x 13'	1.03
949792	0610212	1" x 13'	1.61
949793	0610214	1-1/4" x 13'	2.48
949794	0610216	1-1/2" x 13'	3.89
949795	0610218	2" x 13'	6.19
949796	0610220	2-1/2" x 13'	8.72
949797	0610222	3" x 13'	12.58
949798	0610226	4" x 13'	23.12
949799	0610230	6" x 19'	27.81

### Climatherm® Faser-composite Pipe SDR 7.4/11

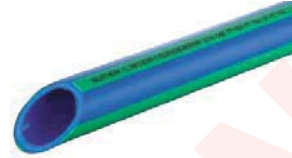

- Heating and cooling applications, industrial applications, compressed air.

Part#	Mfg#	Size	Price
949800	2670708	1/2" x 13'	0.85
949801	2670710	3/4" x 13'	1.32
949802	2670112	1" x 13'	1.52
949803	2670114	1-1/4" x 13'	2.39
949804	2670116	1-1/2" x 13'	3.60
949805	2670118	2" x 13'	5.82
949806	2670120	2-1/2" x 13'	8.26
949807	2670122	3" x 13'	12.03
949808	2670126	4" x 13'	22.39
949809	2670130	6" x 19'	26.12

#### Coils (Non-faser)

Part#	Mfg#	Size	Price
949811	2610310	3/4" x 328'	0.85
949810	2610308	1/2" x 328'	0.62

#### Greenpipe® 90-Elbows

- Socket
- Sizes 6" and above: welded



Part#	Mfg#	Size	Price
949849	0112108	1/2"	1.30
949850	0112110	3/4"	1.66
949851	0112112	1"	2.39
949852	0112114	1-1/4"	3.68
949853	0112116	1-1/2"	7.92
949854	0112118	2"	12.17
949855	0112120	2-1/2"	26.98
949856	0112122	3"	49.80
949857	0112126	4"	109.18
949858	0112130	6" SDR 7.4	125.92
949859	0112131	6" SDR 11	104.03

#### Greenpipe® Street 90-Elbows

- Female/male



Part#	Mfg#	Size	Price
949860	0112308	1/2"	1.30
949861	0112310	3/4"	1.66
949862	0112312	1"	2.39



## Fusion Piping



### Aquatherm PPR Fusion Piping System (Continued)

#### Greenpipe® 90-Elbows

##### Greenpipe® Street 90-Elbows

Part#	Mfg#	Size	Price
949863	0112314	1-1/4"	3.68

#### Greenpipe® Drop 90-Elbow

- Socket x Female



Part#	Mfg#	Size	Price
949987	0120108	1/2"	6.90
953627	0120112	3/4"	10.32
949988	0120113	3/4" x 1/2"	6.90

#### Greenpipe® Socket x Male 90-Elbow



Part#	Mfg#	Size	Price
953635	0123506	1/2"	8.61
953636	0123510	3/4"	9.71

#### Socket x Female 90-Elbow

Part#	Mfg#	Size	Price
953634	0123012	3/4"	10.32

#### Greenpipe® 45-Elbows

- Socket
- Sizes 6" and above: welded



Part#	Mfg#	Size	Price
949864	0112508	1/2"	1.30
949865	0112510	3/4"	1.66
949866	0112512	1"	2.39
949867	0112514	1-1/4"	3.68
949868	0112516	1-1/2"	7.92
949869	0112518	2"	12.02
949870	0112520	2-1/2"	26.65
949871	0112522	3"	49.20
949872	0112526	4"	107.87
949873	0112530	6" SDR 7.4	124.41
949874	0112531	6" SDR 11	102.78

### Greenpipe® Street 45-Elbows



- Female/male

Part#	Mfg#	Size	Price
949875	0112708	1/2"	1.28
949876	0112710	3/4"	1.66
949877	0112712	1"	2.39
949878	0112714	1-1/4"	3.68

### Greenpipe® Tees



- Socket
- Sizes 6" and above: welded

Part#	Mfg#	Size	Price
949879	0113108	1/2"	1.74
949880	0113110	3/4"	2.39
949881	0113112	1"	3.04
949882	0113114	1-1/4"	4.64
949883	0113116	1-1/2"	13.24
949884	0113118	2"	18.96
949885	0113120	2-1/2"	31.77
949886	0113122	3"	58.24
949887	0113126	4"	115.02
949888	0113130	6" SDR 7.4	135.07
949889	0113131	6" SDR 11	102.64
949890	0113511	1/2" x 3/4"	2.39
949891	0113520	3/4" x 1/2"	2.39
949892	0113522	3/4" x 1/2"	2.39
949893	0113532	1" x 1/2"	3.01
949894	0113534	1" x 1/2"	3.01
949895	0113540	1" x 3/4"	3.01
949896	0113542	1-1/4" x 1/2"	4.64
949897	0113544	1-1/4" x 3/4"	4.64
949898	0113546	1-1/4" x 1"	4.64
953289	0113547	1-1/2" x 1/2"	13.24
949900	0113548	1-1/2" x 3/4"	13.24
949901	0113550	1-1/2" x 1"	13.24
949902	0113551	1-1/2" x 1-1/4"	13.24
949903	0113552	2" x 1/2"	17.82
949904	0113554	2" x 3/4"	17.82
949905	0113556	2" x 1"	17.82
949906	0113558	2" x 1-1/4"	17.82
949907	0113560	2" x 1-1/2"	17.82
949908	0113561	2-1/2" x 1/2"	29.05
949909	0113562	2-1/2" x 3/4"	29.05
949910	0113564	2-1/2" x 1"	29.05
949911	0113566	2-1/2" x 1-1/4"	29.05
949912	0113568	2-1/2" x 1-1/2"	29.05
949913	0113570	2-1/2" x 2"	29.05
949914	0113576	3" x 1"	58.24

Prices & specifications are subject to change.

Metropolitan Pipe offers FREE DELIVERY in the Greater Boston area.



## Fusion Piping

### Aquatherm PPR Fusion Piping System (Continued) Greenpipe® Tees

Part#	Mfg#	Size	Price
949915	0113578	3" x 1-1/4"	58.24
949916	0113580	3" x 1-1/2"	58.24
949917	0113582	3" x 2"	58.24
949918	0113584	3" x 2-1/2"	58.24
949919	0113592	4" x 2-1/2"	105.39
949920	0113594	4" x 3"	109.05
949921	0113602	6" x 3" SDR 7.4	299.41
949922	0113603	6" x 3" SDR 11	278.77

#### Greenpipe® Socket x Female Tee



Part#	Mfg#	Size	Price
950006	0125006	1/2"	8.17
950007	0125012	3/4"	10.87
950008	0125016	1"	24.83

#### Greenpipe® Coupling

- Aquatherm Greenpipe® electrofusion device (Part No. 0050175) and peeling tool (Part No. 0050558 - 0050592) Required



Part#	Mfg#	Size	Price
949977	0117208	1/2"	31.02
949978	0117210	3/4"	32.23
949979	0117212	1"	36.10
949980	0117214	1-1/4"	36.68
949981	0117216	1-1/2"	39.57
949982	0117218	2"	57.35
949983	0117220	2-1/2"	67.98
949984	0117222	3"	86.75
949985	0117226	4"	155.04
949986	0117230	6"	189.95

#### Greenpipe® Couplings



Part#	Mfg#	Size	Price
949812	0111008	1/2"	1.21
949813	0111010	3/4"	1.35
949814	0111012	1"	1.77

### Aquatherm PPR Fusion Piping System (Continued) Greenpipe® Couplings

Part#	Mfg#	Size	Price
949815	0111014	1-1/4"	2.13
949816	0111016	1-1/2"	4.46
949817	0111018	2"	8.91
949818	0111020	2-1/2"	9.97
949819	0111022	3"	21.91
949820	0111026	4"	46.76

#### Greenpipe® Bushings



- Female to male for use with standard fitting.

Part#	Mfg#	Size	Price
949821	0111112	3/4" x 1/2"	1.35
949822	0111114	1" x 1/2"	1.80
949823	0111116	1" x 3/4"	1.80
949824	0111118	1-1/4" x 1/2"	2.76
949825	0111120	1-1/4" x 3/4"	2.76
949826	0111122	1-1/4" x 1"	2.76
949827	0111124	1-1/2" x 1/2"	4.57
949828	0111126	1-1/2" x 3/4"	4.57
949829	0111128	1-1/2" x 1"	4.57
949830	0111130	1-1/2" x 1-1/4"	4.57
949831	0111131	2" x 1/2"	9.13
949832	0111132	2" x 3/4"	9.13
949833	0111134	2" x 1"	9.13
949834	0111136	2" x 1-1/4"	9.13
949835	0111138	2" x 1-1/2"	9.13
949836	0111143	2-1/2" x 1/2"	10.21
949837	0111144	2-1/2" x 3/4"	10.21
949838	0111145	2-1/2" x 1"	10.21
949839	0111139	2-1/2" x 1-1/4"	10.21
949840	0111140	2-1/2" x 1-1/2"	10.21
949841	0111142	2-1/2" x 2"	10.21
949842	0111151	3" x 1-1/2"	22.74
949843	0111152	3" x 2"	22.74
949844	0111153	3" x 2-1/2"	22.74
949845	0111161	4" x 2-1/2"	44.35
949846	0111163	4" x 3"	55.17
949847	0111176	6" x 4"	67.97
949848	0111177	6" x 4"	67.97



## Fusion Piping

### Greenpipe® Caps



- Socket

Part#	Mfg#	Size	Price
949923	0114108	1/2"	1.89
949924	0114110	3/4"	2.39
949925	0114112	1"	2.90
949926	0114114	1-1/4"	4.57
949927	0114116	1-1/2"	6.30
949928	0114118	2"	10.54
949929	0114120	2-1/2"	15.27
949930	0114122	3"	34.50
949931	0114126	4"	63.19
949932	0114130	6" SDR 7.4	86.73
949933	0114131	6" SDR 11	86.73

### Greenpipe® Socket Outlets



- With weld-on surface and additional weld-in socket for fusion with the inner pipe wall.

Part#	Mfg#	Size	Price
949934	0115156	1-1/4" x 1/2"	3.27
949935	0115158	1-1/4" x 3/4"	3.27
949936	0115160	1-1/2" x 1/2"	3.71
949937	0115162	1-1/2" x 3/4"	3.71
949938	0115164	2"	4.45
949939	0115166	2"	4.45
949940	0115168	2" x 1"	4.45
949941	0115170	2-1/2" x 1/2"	5.19
949942	0115172	2-1/2" x 3/4"	5.19
949943	0115174	2-1/2" x 1"	5.19
949944	0115175	2-1/2" x 1-1/4"	5.19
949945	0115176	3"	5.94
949946	0115178	3"	5.94
949947	0115180	3" x 1"	5.94
949948	0115181	3" x 1-1/4"	5.94
949949	0115190	4"	7.42
949950	0115192	4"	7.42
949951	0115194	4" x 1"	7.42
949952	0115196	4" x 1-1/4"	7.42
949953	0115197	4" x 1-1/2"	8.45
949954	0115198	4" x 2"	11.59
949955	0115206	6"	8.06
949956	0115208	6"	8.06
949957	0115210	6" x 1"	8.06
949958	0115216	6" x 2"	18.28
949959	0115220	6" x 3"	44.91

### Greenpipe® Female Outlets



- With hex shaped thread, weld-in surface and weld-in socket for fusion with the inner wall of the pipe.

#### Female Outlet

Part#	Mfg#	Size	Price
950009	0128214	1-1/4" x 1/2"	10.16
950054	0128234	1-1/4" x 3/4"	14.53
950010	0128214	1-1/2" x 1/2"	10.16
950055	0128236	1-1/2" x 3/4"	14.53
950011	0128218	2" x 1/2"	10.16
950056	0128238	2" x 3/4"	14.53
950012	0128220	2-1/2" x 1/2"	10.16
950057	0128240	2-1/2" x 3/4"	14.53
950061	0128260	2-1/2" x 1"	21.05
950013	0128222	3" x 1/2"	10.16
950058	0128242	3" x 3/4"	14.53
950062	0128262	3" x 1"	21.05
950014	0128226	4" x 1/2"	10.16
950059	0128246	4" x 3/4"	14.53
950063	0128266	4" x 1"	21.05
950015	0128230	6" x 1/2"	10.16
950060	0128250	6" x 3/4"	14.47
950064	0128270	6" x 1"	21.05

#### Male Outlet

Part#	Mfg#	Size	Price
950040	0128316	1-1/2" x 1/2"	9.99
950041	0128318	2" x 1/2"	9.99
950042	0128320	2-1/2" x 1/2"	9.49
950043	0128322	3" x 1/2"	9.49
950044	0128326	4" x 1/2"	11.98
950045	0128330	6" x 1/2"	12.80
950046	0128314	1-1/4" x 1/2"	9.99
950047	0128334	1-1/4" x 3/4"	13.47
950048	0128336	1-1/2" x 3/4"	13.47
950049	0128338	2" x 3/4"	19.37
950050	0128340	2-1/2" x 3/4"	19.37
950051	0128342	3" x 3/4"	19.37
950052	0128346	4" x 3/4"	19.37
950053	0128350	6" x 3/4"	19.37

### Greenpipe® Flange Adapter



Part#	Mfg#	Size	Price
949960	0115518	2"	8.67

Prices & specifications are subject to change.

Metropolitan Pipe offers Vendor Managed Inventory - never run out of that part again!



## Fusion Piping

### Aquatherm PPR Fusion Piping System (Continued)

#### Greenpipe® Flange Adapter

Part#	Mfg#	Size	Price
949961	0115520	2-1/2"	12.13
949962	0115522	3"	24.67
949963	0115526	4"	93.56
949964	0115530	6"	59.89
949965	0115531	6"	59.89

#### Flange Ring

Part#	Mfg#	Size	Bolts	Price
949966	3315718	2"	4	37.01
949967	3315720	2-1/2"	4	52.34
949968	3315722	3"	8	61.00
949969	3315726	4"	8	92.27
949970	3315730	6"	8	126.03

#### Greenpipe® Socket x Female Adapter

- NPT transition piece with hex-shaped threaded transition



Part#	Mfg#	Size	Price
953628	0121008	1/2" Round	5.91
949989	0121108	1/2"	9.27
949990	0121110	1/2" x 3/4"	10.85
949991	0121111	3/4" x 1/2"	9.27
953633	0121211	3/4" x 1/2" Round	13.91
949992	0121112	3/4"	10.85
949993	0121114	1"	25.38
949994	0121116	1-1/4"	40.10
949995	0121118	1-1/2"	46.51
953631	0121119	2" x 1-1/2"	50.95
949996	0121120	2"	72.01
953632	0121122	2-1/2" x 2"	75.18

#### Greenpipe® Socket x Male Adapter

- NPT transition piece with hex-shaped threaded transition



Part#	Mfg#	Size	Price
949997	0121308	1/2"	10.20
949998	0121310	1/2" x 3/4"	11.66
949999	0121312	3/4"	11.66
950000	0121314	1"	19.53
950038	0121316	1" x 1-1/4"	32.88
950001	0121318	1-1/4"	34.98

### Aquatherm PPR Fusion Piping System (Continued)

#### Greenpipe® Socket x Male Adapter

Part#	Mfg#	Size	Price
950002	0121320	1-1/2"	44.52
950003	0121322	2"	61.68
950004	0121324	2-1/2"	94.56
950005	0121325	3"	147.46

#### Greenpipe® Screw Joint Union

- With PPR nut



Part#	Mfg#	Size	Price
949971	0115838	1/2"	27.45
949972	0115840	3/4"	30.20
949973	0115842	1"	33.63
949974	0115844	1-1/4"	62.01
949975	0115846	1-1/2"	83.74
949976	0115848	2"	99.54

#### Greenpipe® Fusion Ball Valves



#### Socket x Socket Fusion

Part#	Mfg#	Size	Price
950016	0141388	1/2"	46.47
950017	0141390	3/4"	48.72
950018	0141392	1"	58.62
950019	0141394	1-1/4"	74.83
950020	0141396	1-1/2"	98.10
950021	0141398	2"	115.75

#### Socket x Socket Bronze

Part#	Mfg#	Size	Price
953637	0141308	1/2"	36.15
953638	0141310	3/4"	40.70
953639	0141312	1"	49.69
953640	0141314	1-1/4"	75.14
953641	0141316	1-1/2"	114.85
953642	0141318	2"	183.68



## Fusion Piping

### Aquatherm Drill Bit



- For the mounting of weld in fusion outlets

Part#	Mfg#	Size	Price
954383	0050940	1/2 & 3/4"	142.44
954384	0050942	1"	157.82
954385	0050944	1-1/4"	173.25
954386	0050946	1-1/2"	304.87
954387	0050948	2"	392.97
954388	0050950*	2-1/2"	409.42
954389	0050952*	3"	463.19

\* Must be used in fixed drilling machine. Morse taper shank.



### Fusion Piping Tools

#### R63 Hand Socket Fusion Tool



- Manual socket fusion tool for pipes and fittings designed according to safety and welding standard in force. Features an aluminum heating plate and a practical, heat insulated plastic handle.
- Manual socket fusion tool for pipes/fittings
- Welds HDPE, PP, PP-R, PVDF
- For pipe up to 2in
- 800 watts
- 7" x 2" x 14"
- Weight: 4 LB

Part#	Mfg#	Description	Price
950915	R63	With electronic temperature control. Up to 2in pipe.	635.83

#### R125Q Hand Socket Fusion Tool

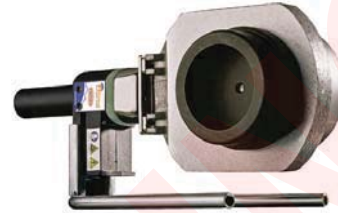

- Manual socket fusion tool for pipes and fittings designed according to safety and welding standard in force. Features an aluminum heating plate and a practical, heat insulated plastic handle.
- Manual socket fusion tool for pipes/fittings
- Welds HDPE, PP, PP-R, PVDF
- For pipe up to 4in
- 1400 watts
- 7" x 2" x 15.5"
- Weight: 7 LB

Part#	Mfg#	Description	Price
950917	R125Q	With electronic temperature control. Up to 4in pipe.	1439.72

#### Prisma 125 Light Socket Welding Machine



- Welding machine Prisma 125 Light is a field machine for socket welding method, for pipe and fittings in Polyethylene (HDPE), Polypropylene (PP), Polyvinyl fluoride (PVDF), Polybutylene (PB) for diameters included between 63 and 125 mm. Available in 110 V and 230 V.
- Building site/workshop machine
- Working range 63 - 125 mm
- Light and easy to transport
- Four self centring clamp
- Sliding trolley

Part#	Mfg#	Description	Price
950948	95500005	Includes: Socket fusion machine, steel case with sockets and spigots from 25 to 125 mm, sliding trolley.	5533.00

Prices & specifications are subject to change.

Our faucet parts counter is one of the largest in the Boston area with thousands of parts in stock!



## Fusion Piping



### Elektra Light Electrofusion Machine



- *Elektra Light is a multipurpose low voltage (8÷48V) electrofusion machine capable of fusing any brand of couplers available in the market for the transport of gas, water and other fluids under pressure (HDPE, PP, PP-R). Elektra Light is light and easy to carry, and meets the international welding standards. Elektra Light has a memory capacity of up to 350 welding cycles, which can subsequently be downloaded (via adapter DB9M-USB - on request) to a USB flash drive or a serial printer.*
- *For high pressure conduits from Ø 20 to 125/160 mm*
- *Optic pen bar code*
- *Memory that registers 350 welding cycles*
- *Data download*
- *110 V - 230 V 50/60 Hz, 2000 W*

Part#	Mfg#	Description	Price
950949	96906080	SUPPLIED WITH: Universal adapter Ø 4,0 - Ø 4.7 mm, Trevira bag, manual scraper.	1900.00

### Saddle Sockets for Fusion Outlet

- *These accessories are necessary for the socket fusion of pipes and fittings.*



Part#	Mfg#	Size	Price
950990	95307000	1-1/4" x 1/2" & 3/4"	126.85
950991	95307001	1-1/2" x 1/2" & 3/4"	126.85
950992	95307002	2" x 1/2" & 3/4"	126.85
950993	95307003	2" x 1"	126.85
950994	95307004	2-1/2" x 1-1/4"	126.85
950995	95307005	2-1/2" x 1"	126.85
950996	95307006	2-1/2" x 1-1/4"	126.85
950997	95307007	3" x 1/2" & 3/4"	134.78
950998	95307008	4" x 2"	134.78

### Fusion Piping Tools (Continued)

#### Saddle Sockets for Fusion Outlet

Part#	Mfg#	Size	Price
950999	95307009	3" x 1-1/4"	134.78
951000	95307014	4" x 1/2" & 3/4"	150.64
951001	95307015	4" x 1"	150.64
951002	95307016	4" x 1-1/4"	150.64
951003	95307017	4" x 1-1/2"	150.64
951004	95307018	4" x 2"	150.64
951005	95307019	6" x 1/2" & 3/4"	198.20
951006	95307020	6" x 1"	198.20
951007	95307021	6" x 1-1/4"	198.20
951008	95307022	6" x 1-1/2"	198.20
951009	95307023	6" x 2"	198.20

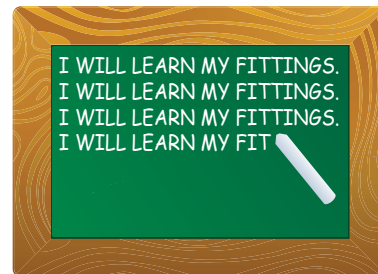

## Product Training

*Met Pipe offers training on every product we sell- from pumps to boilers. Let us organize a group training session for your team today!*





# Pipe



## Black Steel Pipe - Cut - Threaded Both Ends



10' Lengths

Part #	Size	Price
338	1/2"	1.52
339	3/4"	1.81
340	1"	2.60
341	1-1/4"	3.34
342	1-1/2"	4.02
343	2"	5.39
205251	2-1/2"	8.35
205252	3"	10.93
205253	4"	15.45

## A53 Black Steel Pipe PE



21' Lengths

Part #	Size	Price
50217	1/8"	3.55
300	3/8"	5.55
301	1/2"	1.26
302	3/4"	1.50
303	1"	1.71
304	1-1/4"	2.30
305	1-1/2"	2.76
306	2"	3.70
307	2-1/2"	5.66
308	3"	7.41
309	3-1/2"	13.40
310	4"	10.54
31124	5"	19.79
31125	6"	25.67
31126	8"	69.29

## Standard Black T&C Threaded & Coupled - 21' Lengths

Part #	Size	Price
285	1/4"	5.60
286	3/8"	6.40
287	1/2"	1.45
288	3/4"	1.73

## Standard Black T&C (Continued)

Threaded & Coupled - 21' Lengths

Part #	Size	Price
289	1"	2.50
290	1-1/4"	3.24
291	1-1/2"	3.88
292	2"	5.21
293	2-1/2"	7.96
294	3"	10.32
295	4"	10.32

## Extra-Heavy A53 Black Steel Pipe PE



21' Lengths

Part #	Size	Price
323	1/8"	4.51
324	1/4"	5.54
325	3/8"	7.29
326	1/2"	1.68
327	3/4"	2.09
328	1"	2.87
329	1-1/4"	3.80
330	1-1/2"	4.56
331	2"	6.20
332	2-1/2"	9.69
333	3"	13.10
334	4"	18.56

## A106 Black Seamless Pipe PE



Random Lengths - 20' to 21'

Part #	Size	Price
433	1/4"	2.34
434	3/8"	2.54
435	1/2"	1.94
436	3/4"	2.56
437	1"	3.14
438	1-1/4"	4.50
439	1-1/2"	5.35

## A106 Black Seamless Pipe PE (Continued)

Random Lengths - 20' to 21'

Part #	Size	Price
372	2"	5.72
373	2-1/2"	11.00
374	3"	11.84
43744	3-1/2"	19.16
31132	4"	20.53
376	5"	21.87
377	6"	28.32
378	8"	38.06
379	10"	56.04
380	12"	56.50
381	14"	73.16
383	18"	139.56
384	20"	163.36
385	24"	141.20

## Extra-Heavy A106 Black Seamless Pipe PE



Random Lengths - 20' to 21'

Part #	Size	Price
441	1/4"	5.64
442	3/8"	1.07
443	1/2"	2.29
444	3/4"	3.36
445	1"	4.29
446	1-1/4"	5.92
447	1-1/2"	7.19
31143	2"	9.98
31144	2-1/2"	14.65
31145	3"	20.58
31147	3-1/2"	26.82
31148	4"	28.41
31149	5"	26.55
31150	6"	32.95
31151	8"	64.84
31152	10"	84.75
31153	12"	103.16
219796	16"	116.77

Prices & specifications are subject to change.



# Pipe

## Extra Extra-Heavy A106 Black Seamless Pipe PE



Random Lengths - 20' to 21'

Part #	Size	Price
453	1/2"	5.92
454	3/4"	7.31
455	1"	16.42
456	1-1/4"	17.57
457	1-1/2"	15.98
399	2"	17.97
400	2-1/2"	18.16
401	3"	23.35
402	4"	34.76
403	5"	49.72
404	6"	69.50

## A106 Black Seamless Sch 160 Pipe PE



Random Lengths - 20' to 21'

Part #	Size	Price
448	1/2"	6.74
449	3/4"	6.94
450	1"	9.56
451	1-1/4"	7.85
452	1-1/2"	9.12
31156	2"	11.00
31157	2-1/2"	18.37
31158	3"	24.63
31159	4"	38.13
31160	5"	49.26
31161	6"	36.95

## Galvanized Steel Pipe



## A53 Standard Galvanized Steel Pipe PE



21' Lengths

Part #	Size	Price
363	3/4"	2.42

## A53 Standard Galvanized Steel Pipe PE (Continued)

21' Lengths

Part #	Size	Price
364	1"	2.36
365	1-1/4"	3.14
366	1-1/2"	3.77
367	2"	4.96
368	2-1/2"	7.84
369	3"	8.62
371	4"	14.61
31124	5"	19.79
31125	6"	25.67
31126	8"	69.29

## Galvanized Steel Pipe T&C

Threaded & Coupled - 21' Lengths

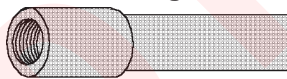

Part #	Size	Price
344	1/8"	6.56
346	3/8"	9.28
347	1/2"	2.24
348	3/4"	2.71
349	1"	4.16
350	1-1/4"	5.44
351	1-1/2"	6.49
352	2"	7.64
353	2-1/2"	14.32
354	3"	16.11
356	4"	26.31

## Extra-Heavy Galvanized Steel Pipe PE



21' Lengths

Part #	Size	Price
458	1/2"	2.81
459	3/4"	3.47
460	1"	4.87
461	1-1/4"	6.51
462	1-1/2"	7.84

## Extra-Heavy Galvanized Steel Pipe PE (Continued)

21' Lengths

Part #	Size	Price
463	2"	10.85
464	2-1/2"	16.96
465	3"	22.69
467	4"	32.02

## Fusion Bond Steel PE Pipe

21' Lengths

Part#	Size	Price
220162	3/4"	3.65
220165	1"	4.50
220166	1-1/4"	6.15
220168	1-1/2"	6.91
220169	2"	7.42
232049	3"	17.16
234358	4"	25.21

## Schedule 10 Steel Pipe

Black Sch 10 Steel Pipe - Grooved - 21' Lengths



Part #	Size	Price
420	2"	2.70
421	2-1/2"	3.64
422	3"	4.47
423	4"	5.79
424	5"	8.32
425	6"	9.96

Galvanized Sch 10 Steel Pipe - Grooved - 21' Lengths

Part #	Size	Price
119744	2-1/2"	4.73
119746	3"	5.82
119745	4"	7.53
Call	5"	Call
135888	6"	Call
Call	8"	Call

Pipe, Fittings, Hardware

Prices & specifications are subject to change.

Metropolitan Pipe offers FREE DELIVERY in the Greater Boston area.



## Cast Iron Fittings

### Threaded Black Cast Iron Fittings

#### Threaded 125# Straight Crosses - Black Cast Iron



Part #	Size	Price
5782	3/4"	14.57
5783	1"	16.97
5784	1-1/4"	23.92
5785	1-1/2"	33.18
5786	2"	43.96

#### Threaded 125# 45° Elbows - Black Cast Iron



Part #	Size	Price
5555	1/4"	6.60
5556	3/8"	7.09
5557	1/2"	5.20
5558	3/4"	5.22
5559	1"	6.12
5560	1-1/4"	8.23
5561	1-1/2"	13.64
5562	2"	15.73
5563	2-1/2"	40.92
5564	3"	64.79
5566	4"	134.71
5568	6"	389.87

#### Threaded 125# 90° Elbows - Black Cast Iron



Part #	Size	Price
5505	1/4"	5.35
5506	3/8"	7.75
5507	1/2"	3.39
5508	3/4"	3.41

### Threaded 125# 90° Elbows - Black Cast Iron (Continued)

Part #	Size	Price
5509	1"	4.02
5510	1-1/4"	5.72
5511	1-1/2"	7.90
5512	2"	12.34
5513	2-1/2"	30.76
5514	3"	50.36
5516	4"	93.37
5517	5"	204.54
5518	6"	265.04

### Threaded 125# 90° Reducing Elbows - Black Cast Iron



Part #	Size	Price
5520	1/2" x 3/8"	10.78
5519	1/2" x 1/4"	8.36
5521	3/4" x 1/2"	7.13
5522	1" x 1/2"	5.28
5523	1" x 3/4"	5.97
5524	1-1/4" x 1/2"	8.41
5525	1-1/4" x 3/4"	8.54
5526	1-1/4" x 1"	7.51
5527	1-1/2" x 1/2"	14.85
5528	1-1/2" x 3/4"	13.84
5529	1-1/2" x 1"	13.84
5530	1-1/2" x 1-1/4"	15.14
5531	2" x 1/2"	23.08
5532	2" x 3/4"	20.27
5533	2" x 1"	20.27
5534	2" x 1-1/4"	21.65
5535	2" x 1-1/2"	20.27
5538	2-1/2" x 1-1/2"	46.12
5539	2-1/2" x 2"	40.90
5542	3" x 2"	71.13
5543	3" x 2-1/2"	77.22
5547	4" x 3"	131.74

## Black Cast Iron Fittings

### Threaded 125# Concentric Reducers - Black Cast Iron



Part #	Size	Price
5442	3/4" x 1/2"	9.49
5443	1" x 1/2"	4.66
5444	1" x 3/4"	6.43
5445	1-1/4" x 1/2"	19.14
5446	1-1/4" x 3/4"	14.24
5447	1-1/4" x 1"	16.66
5448	1-1/2" x 1"	23.57
5449	1-1/2" x 1-1/4"	23.57
5450	2" x 1"	27.44
5451	2" x 1-1/4"	32.19
5452	2" x 1-1/2"	30.83
5453	2-1/2" x 2"	43.81
5454	3" x 2"	53.68
5455	3" x 2-1/2"	69.46
5456	4" x 2"	142.37
5457	4" x 2-1/2"	142.37
5458	4" x 3"	142.37

### Threaded 125# Eccentric Reducers - Black Cast Iron



Part #	Size	Price
5463	3/4" x 1/2"	19.94
5464	1" x 1/2"	20.93
5465	1" x 3/4"	21.54
5466	1-1/4" x 1/2"	34.41
5467	1-1/4" x 3/4"	31.18
5468	1-1/4" x 1"	32.08
5469	1-1/2" x 1/2"	43.32
5470	1-1/2" x 3/4"	45.48
5471	1-1/2" x 1"	45.48
5472	1-1/2" x 1-1/4"	43.48
5473	2" x 1/2"	58.13
5474	2" x 3/4"	65.52
5475	2" x 1"	59.36
5476	2" x 1-1/4"	56.52
5477	2" x 1-1/2"	57.67

Prices & specifications are subject to change.

You can check stock availability, pricing and place orders online at [www.MetPipe.com](http://www.MetPipe.com).



## Cast Iron Fittings



### Threaded 125# Eccentric Reducers - Black Cast Iron (Continued)

Part #	Size	Price
5478	2-1/2" x 1"	90.16
5479	2-1/2" x 1-1/4"	90.16
5480	2-1/2" x 1-1/2"	90.16
5481	2-1/2" x 2"	88.05
5485	3" x 2"	109.17

### Threaded 125# Tees - Black Cast Iron



Part #	Size	Price
5569	1/4"	8.36
5570	3/8"	8.14
5571	1/2"	5.28
5572	3/4"	6.16
5573	1"	5.27
5574	1-1/4"	10.01
5575	1-1/2"	13.01
5576	2"	18.11
5577	2-1/2"	47.06
5578	3"	72.23
5579	3-1/2"	145.67
5580	4"	140.87
5581	5"	385.27
5582	6"	437.39

### Threaded 125# Reducing Run/Outlet Tees - Black Cast Iron



Part #	Size	Price
5657	3/4" x 1/2" x 1/2"	9.95
5658	3/4" x 1/2" x 3/4"	9.95
5659	1" x 1/4" x 1"	12.87
5660	1" x 1/2" x 1/2"	12.35
5661	1" x 1/2" x 3/4"	11.27
5662	1" x 1/2" x 1"	8.14
5663	1" x 3/4" x 1/2"	11.27
5664	1" x 3/4" x 3/4"	10.34
5665	1" x 3/4" x 1"	8.28

### Threaded 125# Reducing Run/Outlet Tees - Black Cast Iron (Continued)

Part #	Size	Price
5666	1-1/4" x 1/2" x 3/4"	18.09
5667	1-1/4" x 1/2" x 1"	17.96
5668	1-1/4" x 1/2" x 1-1/4"	15.29
5669	1-1/4" x 3/4" x 3/4"	17.87
5670	1-1/4" x 3/4" x 1"	17.87
5671	1-1/4" x 3/4" x 1-1/4"	14.59
5672	1-1/4" x 1" x 1/2"	10.01
5673	1-1/4" x 1" x 3/4"	11.33
5674	1-1/4" x 1" x 1"	9.88
5675	1-1/4" x 1" x 1-1/4"	10.92
5592	1-1/4" x 1-1/4" x 1/2"	9.88
5677	1-1/2" x 1/2" x 1-1/2"	20.46
5678	1-1/2" x 3/4" x 1-1/2"	19.98
5680	1-1/2" x 1" x 3/4"	20.53
5681	1-1/2" x 1" x 1"	18.35
5683	1-1/2" x 1" x 1-1/2"	15.29
5684	1-1/2" x 1-1/4" x 1/2"	18.35
5685	1-1/2" x 1-1/4" x 3/4"	14.74
5686	1-1/2" x 1-1/4" x 1"	12.90
5687	1-1/2"x1-1/4"x1-1/4"	18.35
5688	1-1/2"x1-1/4"x1-1/2"	18.35
5595	1-1/2" x 1-1/2" x 1/2"	12.90
5597	1-1/2" x 1-1/2" x 1"	12.90
5598	1-1/2"x1-1/2"x1-1/4"	18.35
5694	2" x 1" x 1"	32.19
5700	2" x 1-1/4" x 1-1/4"	28.65
5701	2" x 1-1/4" x 1-1/2"	32.98
5703	2" x 1-1/2" x 1/2"	20.93
5704	2" x 1-1/2" x 3/4"	20.93
5705	2" x 1-1/2" x 1"	18.29
5706	2" x 1-1/2" x 1-1/4"	28.63
5707	2" x 1-1/2" x 1-1/2"	28.08
5601	2" x 2" x 1"	18.29
5723	2-1/2" x 2" x 2"	54.63
5730	3" x 2" x 2"	93.00
5759	4" x 3" x 2"	190.19

### Threaded 125# Reducing Run Tees - Black Cast Iron

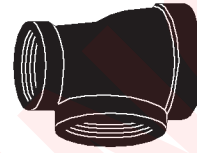

Part #	Size	Price
5658	3/4" x 1/2" x 3/4"	9.95
5662	1" x 1/2" x 1"	8.14
5665	1" x 3/4" x 1"	8.28
5668	1-1/4" x 1/2" x 1-1/4"	15.29
5671	1-1/4" x 3/4" x 1-1/4"	14.59
5675	1-1/4" x 1" x 1-1/4"	10.92
5677	1-1/2" x 1/2" x 1-1/2"	20.46
5678	1-1/2" x 3/4" x 1-1/2"	19.98
5683	1-1/2" x 1" x 1-1/2"	15.29
5688	1-1/2"x1-1/4"x1-1/2"	18.35
5690	2" x 1/2" x 2"	28.65
5692	2" x 3/4" x 2"	26.18
5697	2" x 1" x 2"	28.89
5702	2" x 1-1/4" x 2"	24.93
5708	2" x 1-1/2" x 2"	24.93
5709	2-1/2" x 1/2" x 2-1/2"	53.42
5712	2-1/2" x 1" x 2-1/2"	61.87
5724	2-1/2" x 2" x 2-1/2"	53.60
5725	3" x 3/4" x 3"	95.29
5726	3" x 1" x 3"	93.00
5727	3" x 1-1/4" x 3"	93.00
5732	3" x 2" x 3"	93.00
5738	3" x 2-1/2" x 3"	93.00

### Threaded 125# Reducing Outlet Tees - Black Cast Iron



Part #	Size	Price
5584	1/2" x 1/2" x 3/8"	10.98
5585	3/4" x 3/4" x 1/4"	11.31
5586	3/4" x 3/4" x 3/8"	10.21
5587	3/4" x 3/4" x 1/2"	8.56
5590	1" x 1" x 1/2"	6.19
5591	1" x 1" x 3/4"	7.42
5592	1-1/4" x 1-1/4" x 1/2"	9.88
5593	1-1/4" x 1-1/4" x 3/4"	10.74
5594	1-1/4" x 1-1/4" x 1"	9.88
5595	1-1/2" x 1-1/2" x 1/2"	12.90

Prices & specifications are subject to change.



## Cast Iron Fittings



### Threaded 125# Reducing Outlet Tees - Black Cast Iron (Continued)

Part #	Size	Price
5596	1-1/2" x 1-1/2" x 3/4"	13.93
5597	1-1/2" x 1-1/2" x 1"	12.90
5598	1-1/2"x1-1/2"x1-1/4"	18.35
5599	2" x 2" x 1/2"	18.29
5600	2" x 2" x 3/4"	18.29
5601	2" x 2" x 1"	18.29
5602	2" x 2" x 1-1/4"	20.53
5603	2" x 2" x 1-1/2"	21.70
5604	2-1/2" x 2-1/2" x 1/2"	56.48
5605	2-1/2" x 2-1/2" x 3/4"	53.38
5606	2-1/2" x 2-1/2" x 1"	52.32
5607	2-1/2"x2-1/2"x1-1/4"	53.38
5608	2-1/2"x2-1/2"x1-1/2"	54.63
5609	2-1/2" x 2-1/2" x 2"	53.38
5610	3" x 3" x 1/2"	125.95
5611	3" x 3" x 3/4"	125.95
5612	3" x 3" x 1"	78.32
5613	3" x 3" x 1-1/4"	85.69
5614	3" x 3" x 1-1/2"	93.00
5615	3" x 3" x 2"	79.97
5616	3" x 3" x 2-1/2"	93.00
5625	4" x 4" x 2"	163.77
5626	4" x 4" x 2-1/2"	123.08
5627	4" x 4" x 3"	181.35

### Threaded 125# Bull Tees - Black Cast Iron



Part #	Size	Price
43870	1/2" x 1/2" x 1"	11.77
5641	3/4" x 3/4" x 1"	10.06
5642	1" x 1" x 1-1/4"	11.86
5643	1" x 1" x 1-1/2"	19.65
119330	1-1/4" x 1" x 1-1/2"	18.35
5644	1-1/4"x1-1/4"x1-1/2"	18.35
5645	1-1/4" x 1-1/4" x 2"	29.29
5646	1-1/2" x 1-1/2" x 2"	20.07
5648	2" x 2" x 2-1/2"	46.53
5649	2" x 2" x 3"	83.91

### Threaded X-Heavy Black Cast Iron Fittings

#### Threaded 250# XH 90° Elbows - Black Cast Iron



Part #	Size	Price
5816	1/4"	19.30
5818	1/2"	17.30
5819	3/4"	17.78
5820	1"	21.50
5821	1-1/4"	31.99
5822	1-1/2"	39.69
5823	2"	48.98

#### Threaded 250# XH 45° Elbows - Black Cast Iron



Part #	Size	Price
5807	1/2"	24.64
5808	3/4"	23.79
5809	1"	28.56
5810	1-1/4"	47.06
5811	1-1/2"	51.79
5812	2"	73.64

#### Threaded 250# XH Tees - Black Cast Iron

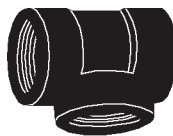

Part #	Size	Price
5829	1/2"	27.28
5830	3/4"	27.11
5831	1"	32.89
5832	1-1/4"	49.06
5833	1-1/2"	63.12
5834	2"	78.30

### Threaded 250# XH Reducing Tees - Black Cast Iron

Part #	Size	Price
5838	3/4" x 1/2"	48.54
5842	1-1/4" x 1"	76.98
5844	1-1/2" x 1"	97.42
5846	2" x 1"	112.84
5847	2" x 1-1/4"	132.47
5848	2" x 1-1/2"	132.47

### Flanged Black Cast Iron Fittings

#### Flanged 125# 45° Elbows - Black Cast Iron



Part #	Size	Price
5950	2"	71.15
5951	2-1/2"	82.69
5952	3"	267.94
5954	4"	301.58
5955	5"	461.54
5956	6"	261.54
5957	8"	305.77

#### Flanged 125# 90° Elbows - Black Cast Iron



Part #	Size	Price
134745	2"	94.64
5937	2-1/2"	192.86
5938	3"	160.98
5940	4"	199.08
5941	5"	471.46
5942	6"	311.68
5943	8"	538.19
217248	4" x 2-1/2"	674.96
5945	4" x 3"	441.63

Prices & specifications are subject to change.

We offer a variety of GREEN products such as flush valves, faucets, showerheads & more!



## Cast Iron Fittings



### Flanged 125# Concentric Reducers - Black Cast Iron



Part #	Size	Price
40328	3" x 2"	357.22
5932	4" x 3"	401.37
203754	5" x 3"	375.00
5933	5" x 4"	620.62
5934	6" x 4"	537.51
5935	6" x 5"	313.46

### Flanged 125# Tees - Black Cast Iron

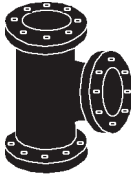

Part #	Size	Price
134740	2"	Call
5958	2-1/2"	284.33
5959	3"	199.28
5961	4"	303.12
5962	5"	811.98
5963	6"	439.87
5964	8"	751.48

### 125# Blind Flanges - Black Cast Iron

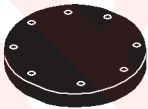

Part #	Size	Price
5849	0" x 4-5/8" (1-1/4")	43.76
5850	0" x 5" (1-1/2")	Call
5851	0" x 6" (2")	52.47
5852	0" x 7" (2-1/2")	57.67
5853	0" x 7-1/2" (3")	69.13
5854	0" x 8-1/2" (3-1/2")	102.11
5855	0" x 9" (4")	88.53
5856	0" x 10" (5")	143.84
5857	0" x 11" (6")	156.47
5858	0" x 13-1/2" (8")	110.73
5859	0" x 16" (10")	363.18

### Flanged X-Heavy Black Cast Iron Fittings

#### XH 250# Blind Flanges - Black Cast Iron

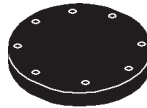

Part #	Size	Price
5900	0" x 6-1/2" (2")	132.64
5902	0" x 8-1/4" (3")	181.02
5903	0" x 10" (4")	264.53
5905	0" x 11" (5")	339.86

### Threaded 150# Floor Flanges - Black Malleable Iron

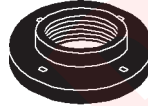

Part #	Size	Price
5798	1/4"	8.52
5799	3/8"	8.52
5800	1/2"	8.52
5801	3/4"	8.52
5802	1"	10.70
5803	1-1/4"	10.70
5804	1-1/2"	13.75
5805	2"	16.55

### Threaded 150# Companion Flanges - Black Malleable Iron



Part #	Size	Price
5861	1" x 4-1/4"	26.03
5862	1-1/4" x 4-5/8"	31.13
5863	1-1/2" x 5"	28.78
5864	2" x 6"	28.71
5865	2-1/2" x 7"	33.58
5866	3" x 7-1/2"	43.26
5867	3-1/2" x 8-1/2"	60.61
5868	4" x 9"	58.30
5869	5" x 10"	82.35
5870	6" x 11"	93.17
5871	8" x 13-1/2"	147.07

### Threaded 150# Reducing Companion Flanges - Black Malleable Iron

Part #	Size	Price
5873	1" x 5"	76.87
5874	1-1/2" x 6"	60.11
5875	1-1/2" x 7"	77.49
5876	1-1/2" x 7-1/2"	92.91
5878	1-1/2" x 9"	137.22
5879	2" x 7"	56.21
5880	2" x 7-1/2"	74.96
5882	2" x 9"	101.89
5883	2" x 11"	186.32
5884	2-1/2" x 7-1/2"	80.46
5885	2-1/2" x 9"	109.32
5886	2-1/2" x 11"	221.39
5888	3" x 9"	101.89
5889	3" x 10"	188.35
5890	3" x 11"	186.32
5893	4" x 10"	157.66
5894	4" x 11"	153.67
5896	5" x 11"	194.77

### Threaded 300# XH Companion Flanges - Black Malleable Iron

Part #	Size	Price
5908	1-1/2" x 6-1/8"	107.54
5909	2" x 6-1/2"	81.84
5910	2-1/2" x 7-1/2"	117.77
5912	3" x 8-1/4"	128.04

## Black Malleable Iron Fittings



### Threaded 150# Black Malleable Iron Fittings

#### Threaded 150# Hex Bushings - Black Malleable Iron



Part #	Size	Price
4550	1/4" x 1/8"	3.55
4551	3/8" x 1/8"	3.55
4552	3/8" x 1/4"	3.44

Prices & specifications are subject to change.



## Malleable Iron Fittings



### Threaded 150# Hex Bushings - Black Malleable Iron (Continued)

Part #	Size	Price
4553	1/2" x 1/8"	3.44
4554	1/2" x 1/4"	3.28
4555	1/2" x 3/8"	3.44
4556	3/4" x 1/8"	3.39
4557	3/4" x 1/4"	3.22
4558	3/4" x 3/8"	3.30
4559	3/4" x 1/2"	2.86
4560	1" x 1/8"	4.82
4561	1" x 1/4"	4.16
4562	1" x 3/8"	4.27
4563	1" x 1/2"	3.17
4564	1" x 3/4"	2.99
4565	1-1/4" x 1/4"	5.97
4566	1-1/4" x 3/8"	5.00
4567	1-1/4" x 1/2"	4.62
4568	1-1/4" x 3/4"	4.07
4569	1-1/4" x 1"	4.07
4570	1-1/2" x 1/4"	6.96
4571	1-1/2" x 3/8"	7.88
4572	1-1/2" x 1/2"	5.28
4573	1-1/2" x 3/4"	5.28
4574	1-1/2" x 1"	4.65
4575	1-1/2" x 1-1/4"	5.15
4576	2" x 1/2"	8.39
4577	2" x 3/4"	6.65
4578	2" x 1"	6.34
4579	2" x 1-1/4"	6.34
4580	2" x 1-1/2"	6.49
4581	2-1/2" x 1/2"	10.89
4582	2-1/2" x 3/4"	11.69
4583	2-1/2" x 1"	11.69
4584	2-1/2" x 1-1/4"	11.69
4585	2-1/2" x 1-1/2"	10.17
4586	2-1/2" x 2"	9.99
4588	3" x 3/4"	17.14
4589	3" x 1"	15.78
4590	3" x 1-1/4"	15.78
4591	3" x 1-1/2"	15.78
4592	3" x 2"	11.80
4593	3" x 2-1/2"	13.67
4596	3-1/2" x 1-1/2"	30.74
4597	3-1/2" x 2"	29.99
4598	3-1/2" x 2-1/2"	30.74
4599	3-1/2" x 3"	27.66
4600	4" x 1"	35.75
4601	4" x 1-1/4"	35.75

### Threaded 150# Hex Bushings - Black Malleable Iron (Continued)

Part #	Size	Price
4602	4" x 1-1/2"	32.94
4603	4" x 2"	26.58
4604	4" x 2-1/2"	32.17
4605	4" x 3"	26.58
4607	5" x 2"	61.93
4609	5" x 3"	55.73
4611	5" x 4"	54.12
4612	6" x 2"	63.89
4613	6" x 2-1/2"	71.02
4614	6" x 3"	63.89
4615	6" x 4"	55.31
4616	6" x 5"	63.89

### Threaded 150# Double Tap Bushings - Black Malleable Iron



Part #	Size	Price
6076	1-1/2" x 1"	9.00
6077	1-1/2" x 1-1/4"	9.26
6081	2" x 1"	12.15
6082	2" x 1-1/4"	12.15
6083	2" x 1-1/2"	9.48
6084	2-1/2" x 1"	20.90
6088	3" x 1"	25.32

### Threaded 150# Caps - Black Malleable Iron



Part #	Size	Price
5060	1/8"	2.34
5061	1/4"	2.45
5062	3/8"	1.97
5063	1/2"	1.78
5064	3/4"	2.42
5065	1"	2.90
5066	1-1/4"	3.99
5067	1-1/2"	5.48
5068	2"	7.68
5069	2-1/2"	18.18
5070	3"	27.02
39540	3-1/2"	61.23
5071	4"	46.31

### Threaded 150# Caps - Black Malleable Iron (Continued)

Part #	Size	Price
42003	6"	202.34

### Threaded 150# Crosses - Black Malleable Iron



Part #	Size	Price
5050	1/4"	8.87
5051	3/8"	9.20
5052	1/2"	9.22
5053	3/4"	11.16
5054	1"	13.75
5055	1-1/4"	22.31
5056	1-1/2"	27.66
5057	2"	45.46
5058	2-1/2"	96.78

### Threaded 150# RH Couplings - Black Malleable Iron



Part #	Size	Price
4787	1/4"	3.28
4788	3/8"	3.28
4789	1/2"	2.44
4790	3/4"	2.84
4791	1"	4.26
4792	1-1/4"	6.78
4793	1-1/2"	7.45
4794	2"	11.03
4795	2-1/2"	31.64
4796	3"	42.77
4797	4"	86.16

### Threaded 150# 45° Elbows - Black Malleable Iron



Part #	Size	Price
4896	1/8"	3.96
4897	1/4"	3.96

Prices & specifications are subject to change.

Our state of the art pipe shop offers cutting, threading, grooving and make-ons up to 36in!



## Malleable Iron Fittings



### Threaded 150# 45° Elbows - Black Malleable Iron (Continued)

Part #	Size	Price
4898	3/8"	3.96
4899	1/2"	2.90
4900	3/4"	3.58
4901	1"	4.69
4902	1-1/4"	8.30
4903	1-1/2"	10.26
4904	2"	15.51
4905	2-1/2"	44.91
4906	3"	58.33
4907	4"	114.38

### Threaded 150# 45° Street Elbows - Black Malleable Iron



Part #	Size	Price
4919	1/8"	6.12
4921	3/8"	5.15
4922	1/2"	4.21
4923	3/4"	6.36
4924	1"	7.42
4925	1-1/4"	12.81
4926	1-1/2"	16.50
4927	2"	27.75

### Threaded 150# 90° Elbows - Black Malleable Iron



Part #	Size	Price
4851	1/8"	2.71
4852	1/4"	2.64
4853	3/8"	2.64
4854	1/2"	1.76
4855	3/4"	2.12
4856	1"	3.69
4857	1-1/4"	6.08
4858	1-1/2"	7.98
4859	2"	13.75
4860	2-1/2"	31.84
4861	3"	46.60

### Threaded 150# 90° Elbows - Black Malleable Iron (Continued)

Part #	Size	Price
4862	4"	100.08

### Threaded 150# 90° Reducing Elbows - Black Malleable Iron



Part #	Size	Price
4863	1/4" x 1/8"	5.24
4864	3/8" x 1/8"	7.31
4865	3/8" x 1/4"	3.70
4867	1/2" x 1/4"	3.57
4868	1/2" x 3/8"	3.48
4869	3/4" x 1/4"	5.57
4870	3/4" x 3/8"	5.00
4871	3/4" x 1/2"	3.57
4873	1" x 1/2"	4.95
4874	1" x 3/4"	4.60
4875	1-1/4" x 1/2"	10.06
4876	1-1/4" x 3/4"	8.61
4877	1-1/4" x 1"	7.73
4878	1-1/2" x 3/4"	12.46
4879	1-1/2" x 1"	10.89
4880	1-1/2" x 1-1/4"	10.89
4881	2" x 3/4"	19.01
4882	2" x 1"	17.93
4883	2" x 1-1/4"	17.93
4884	2" x 1-1/2"	15.78
4886	2-1/2" x 1-1/2"	45.83
4887	2-1/2" x 2"	43.30
4889	3" x 2"	69.99
4890	3" x 2-1/2"	81.01

### Threaded 150# 90° Street Elbows - Black Malleable Iron



Part #	Size	Price
4908	1/8"	3.90
4909	1/4"	3.90
4910	3/8"	3.90

### Threaded 150# 90° Street Elbows - Black Malleable Iron (Continued)

Part #	Size	Price
4911	1/2"	3.79
4912	3/4"	3.64
4913	1"	5.35
4914	1-1/4"	8.30
4915	1-1/2"	11.11
4916	2"	18.04
4917	2-1/2"	45.72
4918	3"	69.79

### Threaded 150# Extension Pieces - Black Malleable Iron

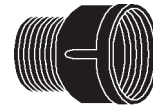

Part #	Size	Price
4845	1/2"	5.64
4846	3/4"	8.30
4847	1"	11.97
4848	1-1/4"	13.86

### Threaded 150# Locknuts - Black Malleable Iron



Part #	Size	Price
5073	1/4"	2.49
5075	1/2"	2.60
5076	3/4"	2.84
5077	1"	5.46
5080	2"	10.43

### Threaded 150# Square Headed Plugs Cored - Black Malleable Iron



Part #	Size	Price
4739	1/2"	1.32
4740	3/4"	1.63
4741	1"	1.63
4742	1-1/4"	2.73
4743	1-1/2"	3.85
4744	2"	4.32

Prices & specifications are subject to change.





## Malleable Iron Fittings



### Threaded 150# Square Headed Plugs Cored - Black Malleable Iron (Continued)

Part #	Size	Price
4745	2-1/2"	10.92
4746	3"	12.65
4747	3-1/2"	30.87
4748	4"	26.05
4749	5"	48.98
4750	6"	63.94

### Threaded 150# Countersunk Square Plugs - Black Malleable Iron



Part #	Size	Price
4769	1"	5.44
4770	1-1/4"	5.85
4773	2-1/2"	14.92
4774	3"	24.38

### Threaded 150# Square Head Solid Plugs - Black Malleable Iron



Part #	Size	Price
4736	1/8"	1.70
4737	1/4"	1.70
4738	3/8"	1.63
4776	1/2"	1.52
4777	3/4"	4.56
4778	1"	4.84
4779	1-1/4"	5.59
4780	1-1/2"	7.92
4781	2"	10.21

### Threaded 150# Reducers - Black Malleable Iron



Part #	Size	Price
4798	1/4" x 1/8"	3.46
4799	3/8" x 1/8"	4.43

### Threaded 150# Reducers - Black Malleable Iron (Continued)

Part #	Size	Price
4800	3/8" x 1/4"	3.46
4801	1/2" x 1/8"	3.48
4802	1/2" x 1/4"	3.13
4803	1/2" x 3/8"	2.97
4804	3/4" x 1/8"	4.12
4805	3/4" x 1/4"	3.96
4806	3/4" x 3/8"	3.96
4807	3/4" x 1/2"	3.33
4808	1" x 1/4"	6.96
4809	1" x 3/8"	6.49
4810	1" x 1/2"	5.28
4811	1" x 3/4"	4.95
4812	1-1/4" x 1/2"	7.79
4813	1-1/4" x 3/4"	6.63
4814	1-1/4" x 1"	6.63
4815	1-1/2" x 1/2"	9.90
4816	1-1/2" x 3/4"	11.16
4817	1-1/2" x 1"	9.73
4818	1-1/2" x 1-1/4"	8.39
4819	2" x 1/2"	16.13
4820	2" x 3/4"	13.91
4821	2" x 1"	13.16
4822	2" x 1-1/4"	13.91
4823	2" x 1-1/2"	12.15
4824	2-1/2" x 1"	35.91
4825	2-1/2" x 1-1/4"	35.91
4826	2-1/2" x 1-1/2"	33.14
4827	2-1/2" x 2"	27.92
4828	3" x 1"	44.47
4829	3" x 1-1/4"	45.28
4830	3" x 1-1/2"	43.65
4831	3" x 2"	36.15
4832	3" x 2-1/2"	42.22
4833	4" x 1-1/2"	104.81
4834	4" x 2"	87.50
4835	4" x 2-1/2"	98.12
4836	4" x 3"	87.50

### Threaded 150# Tees - Black Malleable Iron



Part #	Size	Price
4928	1/8"	4.07

### Threaded 150# Tees - Black Malleable Iron (Continued)

Part #	Size	Price
4929	1/4"	3.83
4930	3/8"	3.83
4931	1/2"	2.35
4932	3/4"	3.37
4933	1"	5.76
4934	1-1/4"	9.71
4935	1-1/2"	12.06
4936	2"	20.57
4937	2-1/2"	44.36
4938	3"	65.32
4939	4"	157.88

### Threaded 150# Reducing Run/Outlet Tees - Black Malleable Iron



Part #	Size	Price
4977	3/8" x 1/4" x 1/4"	9.27
4979	1/2" x 3/8" x 3/8"	6.49
4983	3/4" x 1/2" x 1/2"	5.57
4985	1" x 1/2" x 1/2"	7.79
4986	1" x 1/2" x 3/4"	9.29
4988	1" x 3/4" x 1/2"	7.84
4989	1" x 3/4" x 3/4"	7.24
4993	1-1/4" x 3/4" x 3/4"	14.50
4994	1-1/4" x 3/4" x 1"	13.42
4996	1-1/4" x 1" x 1/2"	15.78
4997	1-1/4" x 1" x 3/4"	12.76
4998	1-1/4" x 1" x 1"	12.76
5003	1-1/2" x 1" x 1"	17.32
5008	1-1/2" x 1-1/4" x 3/4"	17.32
5009	1-1/2" x 1-1/4" x 1"	14.88
5010	1-1/2" x 1-1/4" x 1-1/4"	23.24
5015	2" x 1-1/4" x 1-1/4"	27.02
5016	2" x 1-1/4" x 1-1/2"	34.46
5020	2" x 1-1/2" x 1"	26.54
5021	2" x 1-1/2" x 1-1/4"	27.06
5022	2" x 1-1/2" x 1-1/2"	26.54
5024	2-1/2" x 2" x 2"	66.58
5026	3" x 2" x 2"	81.51
5029	3" x 2-1/2" x 2-1/2"	121.82

Prices & specifications are subject to change.

Metropolitan Pipe offers FREE DELIVERY in the Greater Boston area.



## Malleable Iron Fittings

### Threaded 150# Reducing Run Tees - Black Malleable Iron



Part #	Size	Price
4980	1/2" x 3/8" x 1/2"	6.49
4982	3/4" x 3/8" x 3/4"	16.72
4984	3/4" x 1/2" x 3/4"	6.25
4987	1" x 1/2" x 1"	7.79
4990	1" x 3/4" x 1"	7.92
4992	1-1/4" x 1/2" x 1-1/4"	14.50
4995	1-1/4" x 3/4" x 1-1/4"	13.14
4999	1-1/4" x 1" x 1-1/4"	15.32
5000	1-1/2" x 1/2" x 1-1/2"	17.32
5002	1-1/2" x 3/4" x 1-1/2"	16.04
5006	1-1/2" x 1" x 1-1/2"	17.32
5011	1-1/2"x1-1/4"x1-1/2"	26.12
5012	2" x 1/2" x 2"	27.02
5013	2" x 3/4" x 2"	26.54
5014	2" x 1" x 2"	27.02
5017	2" x 1-1/4" x 2"	29.02
5023	2" x 1-1/2" x 2"	29.24
5025	2-1/2" x 2" x 2-1/2"	69.28
5027	3" x 2" x 3"	92.54
5030	4" x 3" x 4"	245.79

### Threaded 150# Reducing Outlet Tees - Black Malleable Iron



Part #	Size	Price
4940	1/4" x 1/4" x 1/8"	7.92
4942	3/8" x 3/8" x 1/4"	6.01
5033	3/8" x 3/8" x 1/2"	5.68
4944	1/2" x 1/2" x 1/4"	4.16
4945	1/2" x 1/2" x 3/8"	5.33
4946	3/4" x 3/4" x 1/4"	6.01
4947	3/4" x 3/4" x 3/8"	6.65
4948	3/4" x 3/4" x 1/2"	5.42
4950	1" x 1" x 3/8"	9.62
4951	1" x 1" x 1/2"	6.56
4952	1" x 1" x 3/4"	6.82
4953	1-1/4" x 1-1/4" x 1/2"	12.46

### Threaded 150# Reducing Outlet Tees - Black Malleable Iron (Continued)

Part #	Size	Price
4954	1-1/4" x 1-1/4" x 3/4"	10.92
4955	1-1/4" x 1-1/4" x 1"	11.84
4956	1-1/2" x 1-1/2" x 1/2"	14.59
4957	1-1/2" x 1-1/2" x 3/4"	13.78
4958	1-1/2" x 1-1/2" x 1"	13.78
4959	1-1/2"x1-1/2"x1-1/4"	17.03
4960	2" x 2" x 1/2"	22.00
4961	2" x 2" x 3/4"	21.59
4962	2" x 2" x 1"	21.59
4963	2" x 2" x 1-1/4"	23.24
4964	2" x 2" x 1-1/2"	23.24
4965	2-1/2" x 2-1/2" x 1"	67.26
4967	2-1/2"x2-1/2"x1-1/2"	67.26
4968	2-1/2" x 2-1/2" x 2"	57.69
4969	3" x 3" x 1"	77.42
4970	3" x 3" x 1-1/4"	81.58
4971	3" x 3" x 1-1/2"	80.11
4972	3" x 3" x 2"	77.05
4973	3" x 3" x 2-1/2"	91.52
4974	4" x 4" x 2"	179.99
4975	4" x 4" x 2-1/2"	209.49
4976	4" x 4" x 3"	186.85

### Threaded 150# Bull Tees - Black Malleable Iron

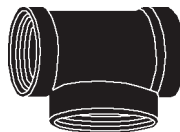

Part #	Size	Price
5033	3/8" x 3/8" x 1/2"	5.68
5034	1/2" x 1/2" x 3/4"	6.25
5035	1/2" x 1/2" x 1"	10.21
5036	3/4" x 3/4" x 1"	8.25
5036	3/4" x 3/4" x 1-1/4"	8.25
5037	1" x 1" x 1-1/4"	15.12
5038	1" x 1" x 1-1/2"	24.78
5039	1-1/4"x1-1/4"x1-1/2"	19.08
5041	1-1/2" x 1-1/2" x 2"	30.72
4966	2-1/2"x2-1/2"x1-1/4"	67.26



### Threaded 150# Wyes - Black Malleable Iron



Part #	Size	Price
5043	1/2"	9.27
5044	3/4"	12.28
5045	1"	16.06
5046	1-1/4"	27.75

### Threaded X-Heavy Black Malleable Iron Fittings

#### Threaded 300# XH Caps - Black Malleable Iron



Part #	Size	Price
5177	1/4"	8.54
5178	3/8"	8.54
5179	1/2"	8.47
5180	3/4"	10.70
5181	1"	14.04
5182	1-1/4"	15.54
5183	1-1/2"	22.71
5184	2"	31.55
5185	2-1/2"	60.81
5186	3"	83.93

#### Threaded 300# XH Crosses - Black Malleable Iron

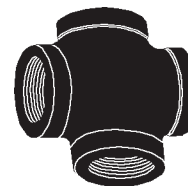

Part #	Size	Price
5169	1/4"	21.35
5172	3/4"	51.51
5173	1"	56.19
5174	1-1/4"	54.27
5175	1-1/2"	98.30
5176	2"	107.03



## Malleable Iron Fittings



### Threaded 300# XH Couplings - Black Malleable Iron



Part #	Size	Price
5084	1/4"	8.34
5085	3/8"	8.34
5086	1/2"	9.31
5087	3/4"	10.70
5088	1"	12.24
5089	1-1/4"	14.55
5090	1-1/2"	21.78
5091	2"	31.38
5092	2-1/2"	57.78
5093	3"	83.21

### Threaded 300# XH 45° Elbows - Black Malleable Iron



Part #	Size	Price
5127	1/4"	13.75
5128	3/8"	13.75
5129	1/2"	15.29
5130	3/4"	17.03
5131	1"	18.81
5132	1-1/4"	30.17
5133	1-1/2"	39.32
5134	2"	59.43
5135	2-1/2"	132.73
5136	3"	174.53

### Threaded 300# XH 90° Elbows - Black Malleable Iron



Part #	Size	Price
5108	1/4"	9.24
5109	3/8"	8.21
5110	1/2"	10.63
5111	3/4"	12.02
5112	1"	15.36
5113	1-1/4"	22.40

### Threaded 300# XH 90° Elbows - Black Malleable Iron (Continued)

Part #	Size	Price
5114	1-1/2"	26.43
5115	2"	38.00
5116	2-1/2"	98.50
5117	3"	113.11

### Threaded 300# XH 90° Reducing Elbows - Black Malleable Iron



Part #	Size	Price
5118	3/4" x 1/2"	14.48
5119	1" x 1/2"	29.81
5120	1" x 3/4"	29.00
5123	1-1/2" x 1"	57.49
5124	1-1/2" x 1-1/4"	57.49
5125	2" x 1-1/4"	80.79
5126	2" x 1-1/2"	72.03

### Threaded 300# XH 90° Street Elbows - Black Malleable Iron



Part #	Size	Price
5137	1/4"	10.94
5138	3/8"	12.26
5139	1/2"	14.30
5140	3/4"	20.31
5141	1"	23.81
5142	1-1/4"	32.74
5143	1-1/2"	40.44
5144	2"	62.95

### Threaded 300# XH Reducers - Black Malleable Iron

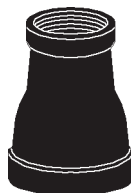

Part #	Size	Price
5094	3/8" x 1/4"	11.03

### Threaded 300# XH Reducers - Black Malleable Iron (Continued)

Part #	Size	Price
36238	1/2" x 1/4"	13.27
5095	1/2" x 3/8"	13.27
5096	3/4" x 1/2"	13.56
5097	1" x 1/2"	16.53
5098	1" x 3/4"	16.20
5099	1-1/4" x 1/2"	33.82
5100	1-1/4" x 3/4"	22.14
5101	1-1/4" x 1"	21.32
5102	1-1/2" x 3/4"	30.34
5103	1-1/2" x 1"	29.22
5104	1-1/2" x 1-1/4"	33.22
5105	2" x 1"	42.35
5106	2" x 1-1/4"	51.31
5107	2" x 1-1/2"	42.00
42895	2-1/2" x 2"	81.76
49525	3" x 2"	119.79
42894	3" x 2-1/2"	124.39

### Threaded 300# XH Tees - Black Malleable Iron



Part #	Size	Price
5145	1/4"	11.64
5146	3/8"	12.32
5147	1/2"	15.69
5148	3/4"	16.92
5149	1"	20.38
5150	1-1/4"	29.20
5151	1-1/2"	34.04
5152	2"	50.25
5153	2-1/2"	122.10
5154	3"	174.07

### Threaded 300# XH Outlet Reducing Tees - Black Malleable Iron



Part #	Size	Price
5156	3/4" x 3/4" x 1/2"	25.02
5157	1" x 1" x 1/2"	30.56

Prices & specifications are subject to change.

Metropolitan Pipe offers Vendor Managed Inventory - never run out of that part again!



## Malleable Iron Fittings



### Threaded 300# XH Outlet Reducing Tees - Black Malleable Iron (Continued)

Part #	Size	Price
5158	1" x 1" x 3/4"	30.56
5159	1-1/4" x 1-1/4" x 3/4"	40.68
5160	1-1/4" x 1-1/4" x 1"	42.24
5162	1-1/2" x 1-1/2" x 3/4"	49.53
5164	1-1/2" x 1-1/2" x 1-1/4"	55.77
5165	2" x 2" x 3/4"	79.82
5166	2" x 2" x 1"	79.82
5167	2" x 2" x 1-1/4"	82.09
5168	2" x 2" x 1-1/2"	74.23
5163	2-1/2" x 2-1/2" x 2"	49.53

### Flanged Black Malleable Iron Unions

#### Flanged 150# Unions - Black Malleable Iron



Part #	Size	Price
5497	1-1/2"	63.43
5498	2"	74.67
5499	2-1/2"	101.09
5500	3"	114.36
5502	4"	155.50
5504	6"	340.21

### Threaded Black Malleable Iron Unions

#### Threaded 150# All Iron Unions - Black Malleable Iron



Part #	Size	Price
4695	1/8"	13.97
4696	1/4"	12.92
4697	3/8"	8.91
4698	1/2"	7.75

### Threaded 150# All Iron Unions - Black Malleable Iron (Continued)

Part #	Size	Price
4699	3/4"	8.91
4700	1"	11.62
4701	1-1/4"	16.65
4702	1-1/2"	20.78
4703	2"	24.14
4704	2-1/2"	74.80
4705	3"	90.05

### Threaded 250# Brass Seat Unions - Black Malleable Iron



Part #	Size	Price
4707	1/4"	15.10
4713	2"	134.96
151592	4"	294.01

### Threaded 300# XH Brass Seat Unions - Black Malleable Iron



Part #	Size	Price
4716	1/8"	20.68
4717	1/4"	18.88
4718	3/8"	19.10
4719	1/2"	15.45
4720	3/4"	17.12
4721	1"	22.33
4722	1-1/4"	36.44
4723	1-1/2"	38.15
4724	2"	47.24
33616	2-1/2"	152.33
33617	3"	197.06

### Threaded 300# Dart Unions

- Bronze seats on both sides to prevent corrosion
- True bearing surfaces
- Can be repeatedly installed and removed

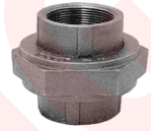

Part #	Size	Price
7600	1/8"	18.34
7601	1/4"	Call
7602	3/8"	Call
7603	1/2"	22.04
7604	3/4"	24.99
7605	1"	32.83
7606	1-1/4"	42.26
7607	1-1/2"	50.78
7608	2"	69.99
7609	2-1/2"	Call
7610	3"	Call
47726	4"	Call

### Galvanized Malleable Iron Fittings



### Galvanized Malleable Iron Fittings

#### Threaded 150# Hex Bushings - Galvanized Malleable Iron



Part #	Size	Price
4646	1/4" x 1/8"	0.78
4647	3/8" x 1/8"	0.96
4648	3/8" x 1/4"	5.50
4650	1/2" x 1/4"	5.50
4651	1/2" x 3/8"	5.50
4653	3/4" x 1/4"	5.77
4654	3/4" x 3/8"	6.45
4655	3/4" x 1/2"	4.93
4656	1" x 1/4"	6.74
4658	1" x 1/2"	6.10
4659	1" x 3/4"	5.68
4660	1-1/4" x 1/4"	9.96
4662	1-1/4" x 1/2"	8.67
4663	1-1/4" x 3/4"	7.66



## Malleable Iron Fittings



### Threaded 150# Hex Bushings - Galvanized Malleable Iron (Continued)

Part #	Size	Price
4664	1-1/4" x 1"	7.66
4665	1-1/2" x 1/2"	10.65
4666	1-1/2" x 3/4"	10.65
4667	1-1/2" x 1"	9.62
4668	1-1/2" x 1-1/4"	9.22
4669	2" x 1/2"	13.36
4670	2" x 3/4"	12.41
4671	2" x 1"	12.41
4672	2" x 1-1/4"	12.41
4673	2" x 1-1/2"	10.70
4674	2-1/2" x 1"	22.60
4675	2-1/2" x 1-1/4"	21.51
4676	2-1/2" x 1-1/2"	20.33
4677	2-1/2" x 2"	17.80
4679	3" x 1-1/2"	26.82
4680	3" x 2"	23.17
4681	3" x 2-1/2"	24.89
4684	4" x 2"	48.65
4685	4" x 2-1/2"	62.44
4686	4" x 3"	48.65

### Threaded 150# Caps - Galvanized Malleable Iron



Part #	Size	Price
5383	1/4"	3.33
5384	3/8"	3.33
5385	1/2"	2.73
5386	3/4"	3.77
5387	1"	4.67
5388	1-1/4"	6.14
5389	1-1/2"	7.88
5390	2"	11.03
5391	2-1/2"	32.01
5392	3"	38.81
5393	4"	85.72

### Threaded 125# Square Headed Plugs Cored - Galvanized Cast Iron



Part #	Size	Price
4753	1/8"	3.37
4754	1/4"	3.37
4755	3/8"	3.37
4756	1/2"	2.89
4757	3/4"	3.63
4758	1"	3.63
4759	1-1/4"	6.08
4760	1-1/2"	8.21
4761	2"	10.19
4762	2-1/2"	21.54
4763	3"	27.57
4765	4"	75.66

### Threaded 150# Couplings - Galvanized Malleable Iron



Part #	Size	Price
5187	1/8"	5.44
5188	1/4"	4.56
5189	3/8"	4.71
5190	1/2"	3.59
5191	3/4"	4.14
5192	1"	6.80
5193	1-1/4"	9.57
5194	1-1/2"	10.89
5195	2"	15.91
5196	2-1/2"	48.71
5197	3"	65.08
5198	4"	138.21

### Threaded 150# 45° Elbows - Galvanized Malleable Iron



Part #	Size	Price
5266	1/4"	6.14
5267	3/8"	5.81
5268	1/2"	3.88

### Threaded 150# 45° Elbows - Galvanized Malleable Iron (Continued)

Part #	Size	Price
5269	3/4"	5.59
5270	1"	6.32
5271	1-1/4"	11.77
5272	1-1/2"	13.84
5273	2"	20.46
5274	2-1/2"	71.22
5275	3"	103.56
5276	4"	173.61

### Threaded 150# 90° Elbows - Galvanized Malleable Iron



Part #	Size	Price
5233	1/8"	4.18
5234	1/4"	3.81
5235	3/8"	3.81
5236	1/2"	2.47
5237	3/4"	3.02
5238	1"	5.59
5239	1-1/4"	8.83
5240	1-1/2"	11.51
5241	2"	18.86
5242	2-1/2"	49.35
5243	3"	81.36
5244	4"	143.51

### Threaded 150# 90° Reducing Elbows - Galvanized Malleable Iron

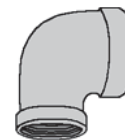

Part #	Size	Price
5247	3/8" x 1/4"	6.10
5248	1/2" x 1/4"	5.04
5249	1/2" x 3/8"	4.51
5252	3/4" x 1/2"	5.24
5254	1" x 1/2"	7.15
5255	1" x 3/4"	6.74
5256	1-1/4" x 1/2"	14.37
5259	1-1/2" x 3/4"	18.02

Prices & specifications are subject to change.

Our faucet parts counter is one of the largest in the Boston area with thousands of parts in stock!



## Malleable Iron Fittings

### Threaded 150# 90° Reducing Elbows - Galvanized Malleable Iron (Continued)

Part #	Size	Price
5264	2" x 1-1/2"	21.06

### Threaded 150# 90° Street Elbows - Galvanized Malleable Iron



Part #	Size	Price
5277	1/8"	5.46
5278	1/4"	5.28
5279	3/8"	5.28
5280	1/2"	5.39
5281	3/4"	5.39
5282	1"	7.22
5283	1-1/4"	12.13
5285	2"	25.63

### Threaded 150# Floor Flanges - Galvanized Malleable Iron



Part #	Size	Price
5396	1/2"	21.26
5397	3/4"	21.26
5398	1"	19.41
5399	1-1/4"	25.79
5400	1-1/2"	33.03

### Threaded 125# Companion Galvanized Cast Iron Flanges

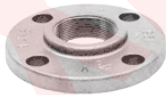

Part #	Size	Price
5925	2" x 6"	60.83
5927	3" x 7-1/2"	86.46
5928	4" x 9"	117.77
5929	6" x 11"	197.61

### Threaded 150# Reducers - Galvanized Malleable Iron



Part #	Size	Price
5199	1/4" x 1/8"	4.67
5201	3/8" x 1/4"	4.67
5203	1/2" x 3/8"	4.36
5204	3/4" x 1/4"	5.31
5206	3/4" x 1/2"	4.67
5208	1" x 1/2"	7.77
5209	1" x 3/4"	7.22
5212	1-1/4" x 3/4"	10.06
5214	1-1/2" x 1/2"	15.21
5215	1-1/2" x 3/4"	12.96
5216	1-1/2" x 1"	12.96
5217	1-1/2" x 1-1/4"	12.24
5218	2" x 1/2"	16.15
5219	2" x 3/4"	21.17
5221	2" x 1/4"	18.68
5220	2" x 1"	17.67
5222	2" x 1-1/2"	16.37
5226	2-1/2" x 2"	49.31
5229	3" x 2"	61.93
5230	3" x 2-1/2"	63.23
5231	4" x 2"	141.79
5232	4" x 3"	141.79

### Threaded 150# Tees - Galvanized Malleable Iron



Part #	Size	Price
5301	3/8"	4.98
5302	1/2"	3.19
5303	3/4"	5.24
5304	1"	8.47
5305	1-1/4"	13.45
5306	1-1/2"	16.72
5307	2"	27.17
5308	2-1/2"	76.50
5309	3"	89.72
5310	4"	212.19

### Threaded 150# Reducing Run/Outlet Tees - Galvanized Malleable Iron

Part #	Size	Price
5346	3/4" x 1/2" x 1/2"	8.30
5352	1" x 3/4" x 1"	12.79
5355	1-1/4" x 1" x 1"	19.25
5323	1-1/2" x 1-1/2" x 1/2"	20.73
5324	1-1/2" x 1-1/2" x 3/4"	19.61
5325	1-1/2" x 1-1/2" x 1"	18.67

### Threaded 150# Reducing Run Tees - Galvanized Malleable Iron

Part #	Size	Price
5352	1" x 3/4" x 1"	12.79
5356	1-1/4" x 1" x 1-1/4"	20.38
5360	1-1/2" x 1-1/4" x 1-1/2"	34.96
5364	2" x 1-1/2" x 2"	33.96

### Threaded 150# Reducing Outlet Tees - Galvanized Malleable Iron

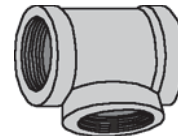

Part #	Size	Price
5315	1/2" x 1/2" x 3/8"	7.40
5316	3/4" x 3/4" x 1/2"	7.29
5318	1" x 1" x 1/2"	10.23
5319	1" x 1" x 3/4"	10.23
5320	1-1/4" x 1-1/4" x 1/2"	16.79
5321	1-1/4" x 1-1/4" x 3/4"	15.87
5322	1-1/4" x 1-1/4" x 1"	15.87
5323	1-1/2" x 1-1/2" x 1/2"	20.73
5324	1-1/2" x 1-1/2" x 3/4"	19.61
5325	1-1/2" x 1-1/2" x 1"	18.67
5328	2" x 2" x 3/4"	28.63
5329	2" x 2" x 1"	28.10
5330	2" x 2" x 1-1/4"	33.71
5331	2" x 2" x 1-1/2"	33.71
5335	2-1/2" x 2-1/2" x 2"	90.23

### Threaded 150# Bull Tees - Galvanized Malleable Iron

Part #	Size	Price
5366	1/2" x 1/2" x 3/4"	8.72



## Malleable Iron Fittings



### Threaded 150# Bull Tees - Galvanized Malleable Iron (Continued)

Part #	Size	Price
5367	3/4" x 3/4" x 1"	12.54

### Threaded 150# Brass Seat Unions - Galvanized Malleable Iron

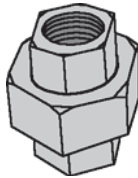

Part #	Size	Price
4726	1/4"	17.52
4727	3/8"	11.73
4728	1/2"	10.70
4729	3/4"	12.30
4730	1"	16.11
4731	1-1/4"	23.28
4732	1-1/2"	28.21
4733	2"	32.43
4734	2-1/2"	112.62
4735	3"	157.63

### Dielectric Fittings

#### Insulation Kits (Continued)

Part #	Size	Price
33621	2"	12.94
33622	2-1/2"	13.60
33623	3"	14.26
33624	4"	28.02
33625	6"	38.02
221623	8"	43.00
221624	10"	90.14

### Dielectric Unions (C x FNPT)



Part #	Size	Price
7621	1/2"	3.34
7622	3/4"	3.34
7623	1"	6.04
7624	1-1/4"	9.36
7625	1-1/2"	14.04
7626	2"	19.97

### Dielectric Nipples (Schedule 40)



Part #	Size	Price
7631	1/2" x 3"	8.31
7632	3/4" x 3"	5.12
7633	1" x 3"	7.99
7634	1-1/4" x 4"	12.12
7635	1-1/2" x 4"	13.63
7636	2" x 4"	16.66
7637	2-1/2" x 6"	25.06
7638	3" x 6"	41.39

### Grinnell 407GT - Clearflow Dielectric Waterway - (Grooved x FNPT)



• Painted

Part #	Size	Price
868042	1-1/2" x 4"	51.79
868857	2" x 4"	52.80
869131	2-1/2" x 6"	71.76
867859	3" x 6"	129.30

### Forged Steel O-Lets



#### Class 3000 Forged Steel Soc-O-Lets

Part #	Outlet Size	Nom Run Pipe Size	Price
92325	1/8"	36 - 1/2"	11.98
92328	3/8"	36 - 3/4"	11.98
92330	1/2"	36 - 3/4"	8.95
92331	3/4"	1 - 3/4"	8.95
165252	3/4"	5 - 3"	911.40
42670	3/4"	36 - 1-1/2"	9.08
92333	1"	2 - 1-1/4"	10.07
92332	1"	36 - 3"	10.07
34914	1-1/4"	1-1/4"	180.30
92335	1-1/4"	2 - 1-1/2"	16.82
92334	1-1/4"	3-1/2 - 2"	16.82
92336	1-1/4"	36 - 4"	16.82
34924	1-1/2"	1-1/2"	16.82
92337	1-1/2"	2-1/2 - 2"	16.82
50937	1-1/2"	5 - 3"	16.82
92339	1-1/2"	36 - 6"	16.82
34935	2"	2-1/2"	19.12
92342	2"	3-1/2 - 3"	19.12
92341	2"	6 - 4"	19.12
92340	2"	36 - 8"	19.12
34945	2-1/2"	3-1/2 - 3"	83.73
34953	2-1/2"	36 - 20"	83.73
34957	3"	4 - 3-1/2"	113.07
34967	4"	5"	167.60
34970	4"	10"	167.60

#### Class 3000 Forged Steel Thread-O-Lets

Part #	Outlet Size	Nom Run Pipe Size	Price
11674	1/8"	36 - 1/2"	14.30
92296	1/4"	36 - 1/2"	22.80
92299	3/8"	36 - 3/4"	14.30
92300	1/2"	3/4 - 1/2"	7.22
56330	1/2"	36 - 3/4"	7.22
11686	3/4"	1-1/2 - 1-1/4"	14.30
50675	3/4"	36 - 1-1/2"	8.32
11691	1"	1"	9.69
92303	1"	2-1/2 - 1-1/4"	9.69
50813	1"	36 - 3"	9.69



### Dielectric Fittings Insulation Kits

*Includes: gasket, sleeves, steel washers & isolation washers*



Part #	Size	Price
221622	1/2"	11.20
122692	3/4"	11.20
122691	1"	11.32
187264	1-1/4"	11.76
159898	1-1/2"	12.02

Prices & specifications are subject to change.

Our office hours are 7am to 4:30pm and counter hours 6am to 4:30pm Monday through Friday.



## Steel Fittings

### Class 3000 Forged Steel Thread-O-Lets (Continued)

Part #	Outlet Size	Nom Run Pipe Size	Price
11700	1-1/4"	1-1/4"	15.36
187441	1-1/4"	3-1/2 - 2"	15.36
50929	1-1/4"	36 - 4"	15.36
11708	1-1/2"	1-1/2"	15.36
92305	1-1/2"	2-1/2 - 2"	15.36
50928	1-1/2"	5 - 3"	15.36
50930	1-1/2"	36 - 6"	15.36
11717	2"	2"	17.48
11718	2"	2-1/2"	17.48
92306	2"	3-1/2 - 2-1/2"	17.48
50941	2"	6 - 4"	17.48
55468	2"	36 - 8"	17.48
11727	2-1/2"	3-1/2 - 3"	58.63
191275	2-1/2"	8 - 6"	58.63
11735	2-1/2"	36 - 10"	58.63
11738	3"	4 - 3-1/2"	71.10
50932	3"	6 - 5"	71.10
203141	3"	14 - 6"	71.10
11744	3"	36 - 16"	71.10
11747	4"	6 - 5"	132.22
11749	4"	10 - 8"	132.22
11751	4"	20 - 12"	132.22

### Class 3000 Forged Steel Weld-O-Lets

Part #	Outlet Size	Nom Run Pipe Size	Price
92311	1/2"	3/4 - 1/2"	14.94
92310	1/2"	36 - 1-1/4"	14.94
92312	3/4"	1 - 3/4"	14.94
11626	3/4"	1-1/2 - 1-1/4"	15.76
92313	3/4"	36 - 2-1/2"	15.76
34778	1"	1"	16.48
92314	1"	36 - 2"	16.48
92315	1-1/4"	2 - 1-1/2"	20.17
92316	1-1/4"	6 - 2-1/2"	21.52
92317	1-1/4"	36 - 8"	20.17
92320	1-1/2"	3-1/2 - 2"	19.57
92318	1-1/2"	36 - 4"	19.57
11645	2"	2"	32.78
92322	2"	3 - 2-1/2"	19.74
92323	2"	6 - 3-1/2"	19.74
92324	2"	36 - 8"	19.74
11651	2-1/2"	5 - 4"	45.20

### Class 3000 Forged Steel Weld-O-Lets (Continued)

Part #	Outlet Size	Nom Run Pipe Size	Price
857453	2-1/2"	8 - 6"	45.20
92974	2-1/2"	10 - 5"	45.20
34827	2-1/2"	36 - 12"	45.20
11656	3"	4 - 3-1/2"	49.47
11657	3"	6 - 5"	49.47
162739	3"	14 - 6"	49.47
34838	3"	36 - 16"	49.47
11662	4"	6 - 5"	62.51
11663	4"	10 - 8"	62.51
11666	4"	20 - 12"	62.51
111620	6"	5"	153.32
114814	6"	6"	179.98
11670	6"	8"	180.30
34863	6"	10"	180.30
92977	6"	18 - 16"	180.30



### 150# Forged Steel Flanges

### Weld Neck Flanges - Raised Face 150# Standard Bore Forged Steel

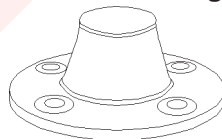

Part #	Size	Price
11464	1/2"	20.24
11465	3/4"	20.24
11466	1"	20.24
11467	1-1/4"	20.24
11468	1-1/2"	20.24
11469	2"	23.18
11470	2-1/2"	25.21
11471	3"	27.51
11472	3-1/2"	33.39
11473	4"	33.39
11474	5"	52.73
11475	6"	62.36
11476	8"	89.11
11477	10"	142.71
11478	12"	207.39

### Weld Neck Flanges - Raised Face 150# Standard Bore Forged Steel (Continued)

Part #	Size	Price
32633	14"	298.95
32634	16"	449.47
32635	18"	632.60
32636	20"	771.09
32637	24"	1299.70

### Weld Neck Flanges - Flat Face 150# Standard Bore Forged Steel

Part #	Size	Price
32638	1/2"	20.24
32639	3/4"	20.24
32640	1"	20.24
32641	1-1/4"	20.24
32642	1-1/2"	20.24
32643	2"	23.18
32644	2-1/2"	25.21
32645	3"	27.51
32647	4"	33.39
32648	5"	66.09
32649	6"	62.36
32650	8"	89.11
32651	10"	178.88
32652	12"	259.95

### Slip On Flanges - Raised Face 150# Standard Bore Forged Steel



Part #	Size	Price
32658	1/2"	13.85
32659	3/4"	13.85
32660	1"	13.85
32661	1-1/4"	13.85
32662	1-1/2"	13.85
11454	2"	15.39
11456	3"	20.90
11457	3-1/2"	26.19
11458	4"	26.19
11459	5"	45.61
11460	6"	43.06
11461	8"	65.38
11462	10"	112.83
11463	12"	167.31
32673	14"	222.30





## Steel Fittings



### Slip On Flanges - Raised Face 150# Standard Bore Forged Steel (Continued)

Part #	Size	Price
32674	16"	347.54
32675	18"	431.81
32676	20"	493.69
32677	24"	713.44

### Reducing Raised Face 150# Slip On Flanges

Part #	Size	Price
32689	2" x 1-1/4"	62.91
32690	2" x 1-1/2"	62.82
11455	2-1/2"	26.33
32692	2-1/2" x 2"	87.64
32697	3" x 2"	66.53
32700	4" x 2"	71.18
32701	4" x 2-1/2"	71.10
32702	4" x 3"	71.18
32709	6" x 2-1/2"	192.84
32711	6" x 4"	192.84
32712	6" x 5"	192.84
32713	8" x 3"	243.05
32714	8" x 4"	243.05
32716	8" x 6"	243.05
32723	12" x 8"	574.09

### Slip On Flanges - Flat Face 150# Standard Bore Forged Steel

Part #	Size	Price
32724	1/2"	13.85
32725	3/4"	17.35
32726	1"	13.85
32727	1-1/4"	17.35
32728	1-1/2"	17.35
32729	2"	19.23
32730	2-1/2"	26.33
32731	3"	20.90
32733	4"	26.19
32734	5"	45.61
32735	6"	43.06
32736	8"	65.38
32737	10"	112.83
32738	12"	167.31
32739	14"	278.64

### Socket Weld Flanges - Raised Face 150# Standard Bore Forged Steel

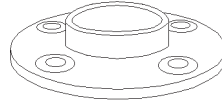

Part #	Size	Price
32821	1/2"	18.28
32822	3/4"	18.28
32823	1"	18.28
32824	1-1/4"	18.28
32825	1-1/2"	18.28
32826	2"	20.13
32827	2-1/2"	27.04
32828	3"	25.64
32830	4"	33.38
32832	6"	68.41
32833	8"	78.65

### Socket Weld Flanges - Flat Face 150# Standard Bore Forged Steel

Part #	Size	Price
32839	1/2"	18.28
32840	3/4"	22.91
32841	1"	18.28
32842	1-1/4"	18.28
32843	1-1/2"	18.28
32844	2"	20.13
234861	2-1/2"	27.04
32845	3"	25.64
223587	4"	41.86

### Threaded Flanges - Raised Face 150# Forged Steel

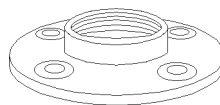

Part #	Size	Price
32744	1/2"	20.86
32745	3/4"	20.86
32746	1"	20.86
32747	1-1/4"	20.86
32748	1-1/2"	20.86
32749	2"	23.36
32750	2-1/2"	28.63
32751	3"	28.81
32752	4"	41.56
32753	5"	58.55
32754	6"	57.91

### Threaded Flanges - Raised Face 150# Forged Steel (Continued)

Part #	Size	Price
32755	8"	99.39

### Reducing Raised Face 150# Threaded Flanges

Part #	Size	Price
32587	2" x 1"	81.69
32588	2" x 1-1/4"	81.80
32589	2" x 1-1/2"	81.69
32591	2-1/2" x 1-1/4"	95.91
32592	2-1/2" x 1-1/2"	96.04
32595	3" x 1-1/4"	86.87
32597	3" x 2"	120.36
32598	3" x 2-1/2"	86.98
32600	4" x 1-1/2"	92.15
32601	4" x 2"	92.15
32602	4" x 2-1/2"	92.15
32603	4" x 3"	92.03
32617	8" x 6"	367.82

### Threaded Flanges - Flat Face 150# Forged Steel

Part #	Size	Price
32759	3/4"	20.86
32760	1"	20.86
32761	1-1/4"	20.86
32762	1-1/2"	20.86
32763	2"	23.36
32764	2-1/2"	28.63
32765	3"	25.00
32766	4"	41.97
32767	5"	52.69
32768	6"	57.91

### Blind Flanges - Raised Face 150# Forged Steel

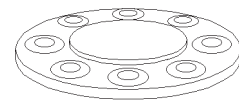

Part #	Size	Price
32772	1/2"	16.61
32773	3/4"	16.61
32774	1"	16.61
32775	1-1/4"	16.61
32776	1-1/2"	16.61
32777	2"	18.55
32778	2-1/2"	28.21

Prices & specifications are subject to change.

You can check stock availability, pricing and place orders online at [www.MetPipe.com](http://www.MetPipe.com).



## Steel Fittings



### Blind Flanges - Raised Face 150# Forged Steel (Continued)

Part #	Size	Price
32779	3"	23.64
32781	4"	33.13
32782	5"	43.57
32783	6"	50.44
32784	8"	82.76
32785	10"	159.39
32786	12"	240.06
32787	14"	397.54
32788	16"	586.73
32789	18"	795.42
32790	20"	999.83
32791	24"	1380.04

### Blind Flanges - Flat Face 150# Forged Steel

Part #	Size	Price
32792	1/2"	16.61
32793	3/4"	16.61
32794	1"	16.61
32796	1-1/2"	16.61
32797	2"	18.55
32799	3"	23.64
32801	4"	33.13
32803	6"	50.44
32804	8"	103.74
32805	10"	159.39
32806	12"	240.06

### Lap Joint Flanges - 150# Forged Steel



Part #	Size	Price
32808	3/4"	14.59
32809	1"	14.59
32810	1-1/4"	14.59
32811	1-1/2"	14.59
32812	2"	16.26
32813	2-1/2"	26.18
32814	3"	22.13
32815	4"	27.16
32816	5"	42.62
32817	6"	45.61
32818	8"	72.31

### Lap Joint Flanges - 150# Forged Steel (Continued)

Part #	Size	Price
32819	10"	143.19
32820	12"	209.48

### Stub Ends - 150# Carbon Steel



Part #	Size	Price
32275	1"	81.82
32276	1-1/4"	81.82
32277	1-1/2"	81.82
32278	2"	81.82
32279	2-1/2"	84.21
32280	3"	84.21
32281	4"	119.79
32282	5"	119.79
32283	6"	228.07

### 300# Forged Steel Flanges Weld Neck Flanges - Raised Face 300# Standard Bore Forged Steel



Part #	Size	Price
32846	1/2"	Call
32847	3/4"	24.37
32848	1"	24.37
32849	1-1/4"	24.37
32850	1-1/2"	24.37
32851	2"	30.32
11590	2-1/2"	34.71
11591	3"	35.07
11592	4"	57.65
11593	5"	87.79
11594	6"	89.63
11595	8"	154.48
11596	10"	415.95
11597	12"	359.56
32866	14"	773.19

### Slip On Flanges - Raised Face 300# Standard Bore Forged Steel

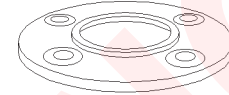

Part #	Size	Price
32877	1/2"	18.46
32878	3/4"	18.46
32879	1"	18.46
32880	1-1/4"	18.46
32881	1-1/2"	18.46
32882	2"	24.52
11601	2-1/2"	27.69
11602	3"	30.15
11603	4"	43.42
11604	5"	75.33
11605	6"	75.56
11606	8"	128.98
11607	10"	220.04
11608	12"	270.60
32892	14"	845.12
223515	16"	929.29
40803	18"	922.44
53969	20"	1022.15

### Socket Weld Flanges - Raised Face 300# Standard Bore Forged Steel

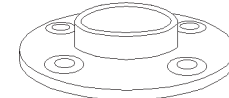

Part #	Size	Price
32931	1/2"	28.92
32932	3/4"	23.07
32933	1"	23.07
32934	1-1/4"	23.07
32935	1-1/2"	23.07
32936	2"	26.28
32937	2-1/2"	39.79
32938	3"	41.74
32939	4"	68.08
32940	5"	86.79

Pipe, Fittings, Hardware



## Steel Fittings



### Threaded Flanges - Raised Face 300# Forged Steel

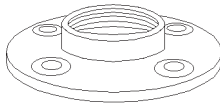

Part #	Size	Price
32893	1/2"	28.92
32894	3/4"	23.07
32895	1"	23.07
32896	1-1/4"	23.07
32897	1-1/2"	23.07
32898	2"	26.81
32899	2-1/2"	37.53
32900	3"	39.99
32901	4"	57.56
32903	6"	135.04

### Blind Flanges - Raised Face 300# Forged Steel

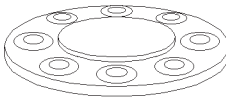

Part #	Size	Price
32904	1/2"	27.07
32905	3/4"	21.60
32906	1"	21.60
32907	1-1/4"	21.60
32908	1-1/2"	21.60
32909	2"	24.17
32910	2-1/2"	42.45
32911	3"	34.44
32912	4"	54.84
32913	5"	95.08
32914	6"	95.08
32915	8"	148.84
32916	10"	296.64
32917	12"	428.56

### Lap Joint Flanges - 300# Forged Steel



Part #	Size	Price
32920	3/4"	20.12
32921	1"	20.12
32922	1-1/4"	20.12
32923	1-1/2"	20.12

### Lap Joint Flanges - 300# Forged Steel (Continued)

Part #	Size	Price
32924	2"	23.12
32925	2-1/2"	33.31
32926	3"	34.71
32927	4"	52.71
32928	5"	87.79
32929	6"	94.47

### Stub Ends - 300# Carbon Steel



Part #	Size	Price
32549	3/4"	92.84
32550	1"	92.84
32551	1-1/2"	Call
32552	2"	92.84
32553	2-1/2"	89.24
32554	3"	102.42
32555	4"	135.24
32556	6"	446.08

### 600# Forged Steel Flanges

#### Weld Neck Flanges - Raised Face 600# Standard Bore Forged Steel

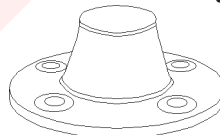

Part #	Size	Price
32955	1-1/2"	29.53
32956	2"	34.01
32957	2-1/2"	46.66
32958	3"	49.04
32960	4"	87.53
32961	5"	80.83
32962	6"	172.85
32963	8"	416.90

#### Slip On Flanges - Raised Face 600# Standard Bore Forged Steel

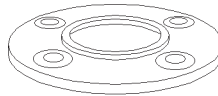

Part #	Size	Price
32979	1/2"	27.32

### Slip On Flanges - Raised Face 600# Standard Bore Forged Steel (Continued)

Part #	Size	Price
32980	3/4"	27.32
32981	1"	27.32
32983	1-1/2"	27.32
32984	2"	32.96
32986	3"	61.79
32987	4"	98.69
32989	6"	224.87
32990	8"	358.08

### Socket Weld Flanges - Raised Face 600# Standard Bore Forged Steel

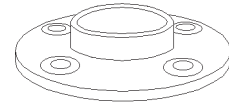

Part #	Size	Price
33025	1/2"	42.26
33026	3/4"	52.97
33027	1"	42.26
33028	1-1/4"	52.97
33029	1-1/2"	Call
33030	2"	45.88
33032	3"	62.07
33033	4"	101.69

### Socket Weld Flanges - Raised Face 600# XH Bore Forged Steel

Part #	Size	Price
33034	1/2"	42.26
33035	3/4"	42.26
33036	1"	Call
33037	1-1/4"	42.26
33038	1-1/2"	42.26
33039	2"	57.50

### Blind Flanges - Raised Face 600# Forged Steel

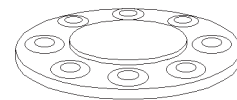

Part #	Size	Price
33004	1"	26.58
33005	1-1/4"	26.58
33006	1-1/2"	26.58
33007	2"	33.48

Prices & specifications are subject to change.

We offer a variety of GREEN products such as flush valves, faucets, showerheads & more!



## Steel Fittings



### Blind Flanges - Raised Face 600# Forged Steel (Continued)

Part #	Size	Price
33009	3"	47.44
33011	5"	Call
33010	4"	83.29
33012	6"	258.60
33013	8"	402.23
33014	10"	660.76

### 1500# Forged Steel Flanges

#### Slip On Flanges - Raised Face 1500# Standard Bore Forged Steel

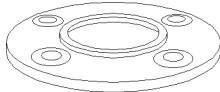

Part #	Size	Price
33052	1/2"	125.78
33053	3/4"	Call
33054	1"	133.85
33056	1-1/2"	125.78
33057	2"	125.78

### 3000# Forged Steel Fittings Threaded Caps - 3000# Forged Steel



Part #	Size	Price
8111	1/4"	3.44
8112	3/8"	3.44
8113	1/2"	3.34
8114	3/4"	4.66
8115	1"	7.14
8116	1-1/4"	11.50
8117	1-1/2"	13.74
8118	2"	19.78
31691	2-1/2"	54.45

### Threaded Couplings - 3000# Forged Steel



Part #	Size	Price
8001	1/8"	3.56
8002	1/4"	3.56
8003	3/8"	3.56
8004	1/2"	2.93
8005	3/4"	3.81
8006	1"	6.63
8007	1-1/4"	11.05
8008	1-1/2"	14.29
8009	2"	17.83
31576	2-1/2"	44.11
31577	3"	83.37
31578	4"	156.38

### Threaded Reducing Couplings - 3000# Forged Steel

Part #	Size	Price
7992	3/8" x 1/4"	5.83
7993	1/2" x 1/4"	5.83
7994	3/4" x 1/4"	6.91
7995	3/4" x 1/2"	6.91
31559	1" x 1/2"	9.00
31560	1" x 3/4"	9.00
31561	1-1/4" x 1/2"	15.76
31562	1-1/4" x 3/4"	15.76
7996	1-1/4" x 1"	15.76
31563	1-1/2" x 1/2"	17.11
31564	1-1/2" x 3/4"	17.11
31565	1-1/2" x 1"	17.11
31566	1-1/2" x 1-1/4"	17.11
31567	2" x 1/2"	24.82
31568	2" x 3/4"	24.82
31569	2" x 1"	24.82
7997	2" x 1-1/2"	24.82

### Threaded Half Couplings - 3000# Forged Steel

Part #	Size	Price
8010	1/8"	1.86
8011	1/4"	1.86
8012	3/8"	1.92
8013	1/2"	1.79
8014	3/4"	2.56
8015	1"	3.51

### Threaded Half Couplings - 3000# Forged Steel (Continued)

Part #	Size	Price
8016	1-1/4"	6.35
8017	1-1/2"	8.44
8018	2"	11.34

### Threaded 90° Elbows - 3000# Forged Steel

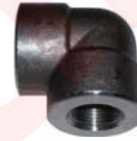

Part #	Size	Price
31608	1/8"	8.35
8074	1/4"	9.14
8075	3/8"	9.14
8076	1/2"	7.01
8077	3/4"	8.79
8078	1"	13.06
8079	1-1/4"	24.81
8080	1-1/2"	32.01
8081	2"	38.87
31609	2-1/2"	115.06
31610	3"	165.75

### Threaded 90° Street Elbows - 3000# Forged Steel



Part #	Size	Price
8093	3/8"	13.18
8094	1/2"	13.18
8095	3/4"	16.66
8097	1-1/4"	40.25

### Threaded 45° Elbows - 3000# Forged Steel



Part #	Size	Price
8082	1/4"	11.60
8083	3/8"	11.60
8084	1/2"	11.44

Prices & specifications are subject to change.



## Steel Fittings

### Threaded 45° Elbows - 3000# Forged Steel (Continued)

Part #	Size	Price
8085	3/4"	13.21
8086	1"	17.99
8087	1-1/4"	22.71
8088	1-1/2"	35.70
8089	2"	49.26

### Threaded Tees - 3000# Forged Steel



Part #	Size	Price
31638	1/8"	11.10
8100	1/4"	11.10
8101	3/8"	11.10
8102	1/2"	10.00
8103	3/4"	13.50
8104	1"	17.78
8105	1-1/4"	34.50
8106	1-1/2"	40.25
8107	2"	52.04
31639	2-1/2"	141.02
31640	3"	438.16

### Square Head Plugs - 3000# Forged Steel



Part #	Size	Price
8119	1/8"	1.55
8120	1/4"	1.55
8121	3/8"	1.63
8122	1/2"	1.71
8123	3/4"	2.12
8124	1"	3.25
8125	1-1/4"	6.70
8126	1-1/2"	7.65
8127	2"	12.08
8128	2-1/2"	31.07
8129	3"	52.01

### Hex Head Plugs - 3000# Forged Steel

Part #	Size	Price
31343	1/8"	1.30
31344	1/4"	1.30
31345	3/8"	1.35
144885	1/2"	1.35
31347	3/4"	2.51
31348	1"	3.53
31349	1-1/4"	6.01
31350	1-1/2"	8.54
31351	2"	13.25
47576	2-1/2"	29.87
31353	3"	44.29

### Countersunk Hex Plugs

- ASTM A105 Steel

Part #	Size	Price
30101	3/8"	3.10
30502	1/2"	7.28
28689	1-1/4"	13.40
56859	1-1/2"	51.90
28136	2"	54.00

### Threaded Hex Bushings - 3000# Forged Steel



Part #	Size	Price
8021	1/4" x 1/8"	2.15
8022	3/8" x 1/8"	2.15
8023	3/8" x 1/4"	2.15
8024	1/2" x 1/8"	2.16
8025	1/2" x 1/4"	2.16
8026	1/2" x 3/8"	2.16
8027	3/4" x 1/8"	2.65
8028	3/4" x 1/4"	2.65
8029	3/4" x 3/8"	2.65
8030	3/4" x 1/2"	2.65
31321	1" x 1/8"	4.31
8031	1" x 1/4"	4.31
8032	1" x 3/8"	4.31
8033	1" x 1/2"	4.31
8034	1" x 3/4"	4.31
8035	1-1/4" x 1/4"	7.03
8036	1-1/4" x 3/8"	7.03
8037	1-1/4" x 1/2"	7.03

### Threaded Hex Bushings - 3000# Forged Steel (Continued)

Part #	Size	Price
8038	1-1/4" x 3/4"	7.03
8039	1-1/4" x 1"	7.03
8040	1-1/2" x 1/4"	8.10
8041	1-1/2" x 3/8"	8.10
8042	1-1/2" x 1/2"	8.10
8043	1-1/2" x 3/4"	8.10
8044	1-1/2" x 1"	8.10
8045	1-1/2" x 1-1/4"	8.10
31324	2" x 1/4"	12.16
8046	2" x 3/8"	12.16
8047	2" x 1/2"	12.16
8048	2" x 3/4"	12.16
8049	2" x 1"	12.16
8050	2" x 1-1/4"	12.16
8051	2" x 1-1/2"	12.16
31327	2-1/2" x 1/2"	38.10
8052	2-1/2" x 3/4"	38.10
8053	2-1/2" x 1"	38.10
8054	2-1/2" x 1-1/4"	38.10
8055	2-1/2" x 1-1/2"	38.10
8056	2-1/2" x 2"	38.10
31331	3" x 3/4"	58.94
8057	3" x 1"	58.94
8058	3" x 1-1/4"	58.94
8059	3" x 1-1/2"	58.94
8060	3" x 2"	58.94
8061	3" x 2-1/2"	58.94
8062	4" x 2"	127.69
8063	4" x 2-1/2"	127.69
8064	4" x 3"	127.69

### Threaded Unions - 3000# Forged Steel



Part #	Size	Price
8065	1/8"	14.37
8066	1/4"	14.37
8067	3/8"	14.62
8068	1/2"	12.42
8069	3/4"	15.20
8070	1"	19.86
8071	1-1/4"	31.50
8072	1-1/2"	37.57

Prices & specifications are subject to change.

Our state of the art pipe shop offers cutting, threading, grooving and make-ons up to 36in!



## Steel Fittings



### Threaded Unions - 3000# Forged Steel (Continued)

Part #	Size	Price
8073	2"	50.93
31579	2-1/2"	126.22
31580	3"	148.60

### Threaded Crosses - 3000# Forged Steel

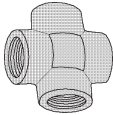

Part #	Size	Price
31679	1/4"	38.29
31681	1/2"	24.73
31682	3/4"	34.03
31683	1"	27.68
31684	1-1/4"	63.45
31685	1-1/2"	54.06
31686	2"	77.89

### Socket Weld Caps - 3000# Forged Steel

Part #	Size	Price
7984	1/2"	4.59
7985	3/4"	5.35
7986	1"	8.12
7987	1-1/4"	9.56
7988	1-1/2"	13.28
7989	2"	20.48

### Socket Weld Couplings - 3000# Forged Steel



Part #	Size	Price
7898	1/8"	9.47
7899	1/4"	7.89
7900	3/8"	7.89
7901	1/2"	3.64
7902	3/4"	4.72
7903	1"	5.20
7904	1-1/4"	9.22
7905	1-1/2"	10.20
7906	2"	16.28
7907	2-1/2"	36.40
7908	3"	81.82
31406	4"	123.03

### Socket Weld Reducing Couplings - 3000# Forged Steel

Part #	Size	Price
7917	3/8" x 1/4"	21.24
7921	3/4" x 1/2"	12.95
7922	1" x 1/4"	18.07
7924	1" x 1/2"	18.07
7925	1" x 3/4"	18.07
7926	1-1/4" x 1/2"	23.09
7928	1-1/4" x 1"	23.09
7930	1-1/2" x 3/4"	24.75
7931	1-1/2" x 1"	24.75
7932	1-1/2" x 1-1/4"	24.75
7933	2" x 1/2"	27.36
7934	2" x 3/4"	27.36
7935	2" x 1"	27.36
7936	2" x 1-1/4"	27.36
7937	2" x 1-1/2"	27.36

### Socket Weld Reducer Inserts - 3000# Forged Steel

Part #	Size	Price
31429	1/2" x 1/4"	7.03
31430	1/2" x 3/8"	6.27
8130	3/4" x 1/4"	8.58
31432	3/4" x 1/2"	8.58
31435	1" x 1/2"	9.39
31436	1" x 3/4"	9.39
31437	1-1/4" x 1/2"	11.01
31438	1-1/4" x 3/4"	11.01
31439	1-1/4" x 1"	11.01
31440	1-1/2" x 1/2"	11.01
31441	1-1/2" x 3/4"	13.76
31442	1-1/2" x 1"	13.76
31443	1-1/2" x 1-1/4"	13.76
31444	2" x 1/2"	18.84
31445	2" x 3/4"	18.84
31446	2" x 1"	18.84
31447	2" x 1-1/4"	18.84
31448	2" x 1-1/2"	18.84
31453	2-1/2" x 2"	130.73
31462	4" x 3"	145.65

### Socket Weld Half Couplings - 3000# Forged Steel

Part #	Size	Price
7912	1-1/4"	11.36
7913	1-1/2"	11.32

### Socket Weld Half Couplings - 3000# Forged Steel (Continued)

Part #	Size	Price
7915	2-1/2"	150.00

### Socket Weld 90° Elbows - 3000# Forged Steel



Part #	Size	Price
7948	1/4"	12.42
7949	3/8"	12.42
7950	1/2"	6.93
7951	3/4"	7.21
7952	1"	9.26
7953	1-1/4"	17.79
7954	1-1/2"	20.67
7955	2"	30.39
7956	2-1/2"	86.39
7957	3"	149.21
7958	4"	394.02

### Socket Weld 45° Elbows - 3000# Forged Steel



Part #	Size	Price
7959	1/4"	12.48
7960	3/8"	12.48
7961	1/2"	9.23
7962	3/4"	10.72
7963	1"	14.03
7964	1-1/4"	19.23
7965	1-1/2"	23.57
7966	2"	37.91
7967	2-1/2"	99.52
7968	3"	165.38
7969	4"	325.92

### Socket Weld Tees - 3000# Forged Steel



Part #	Size	Price
7970	1/4"	13.72
7971	3/8"	13.72
7972	1/2"	8.58

Prices & specifications are subject to change.



## Steel Fittings



### Socket Weld Tees - 3000# Forged Steel (Continued)

Part #	Size	Price
7973	3/4"	10.49
7974	1"	14.25
31487	1" x 1" x 1/2"	26.02
7975	1-1/4"	21.89
31490	1-1/4" x 1-1/4" x 3/4"	39.99
7976	1-1/2"	29.01
31494	1-1/2" x 1-1/2" x 1/2"	52.99
31495	1-1/2" x 1-1/2" x 3/4"	52.99
31496	1-1/2" x 1-1/2" x 1"	52.99
7977	2"	41.88
31498	2" x 2" x 1/2"	76.49
180368	2" x 2" x 1-1/4"	76.49
180366	2" x 2" x 1-1/2"	76.49
7978	2-1/2"	120.29
31504	2-1/2" x 2-1/2" x 1"	219.70
7979	3"	287.60
7980	4"	462.80

### Socket Weld Unions - 3000# Forged Steel



Part #	Size	Price
7938	1/4"	16.92
7939	3/8"	16.92
7940	1/2"	14.18
7941	3/4"	16.54
7942	1"	21.31
7943	1-1/4"	34.28
7944	1-1/2"	37.22
7945	2"	53.59
7946	2-1/2"	135.10
7947	3"	162.87

### Socket Weld Crosses - 3000# Forged Steel

Part #	Size	Price
31543	1/2"	31.14
31546	1-1/4"	37.55
31547	1-1/2"	62.17
31548	2"	89.58

### 2000# Forged Steel Fittings

#### Threaded 90° Elbows - 2000# Forged Steel



Part #	Size	Price
7870	1/4"	6.39
7871	3/8"	7.39
7872	1/2"	6.47
7873	3/4"	7.06
7874	1"	9.09
7875	1-1/4"	18.18
7876	1-1/2"	22.18
7877	2"	30.39
7878	2-1/2"	80.03
7879	3"	123.57

#### Threaded 45° Elbows - 2000# Forged Steel



Part #	Size	Price
7880	1/4"	9.55
7881	3/8"	9.90
7882	1/2"	9.41
7883	3/4"	10.54
7884	1"	12.33
7885	1-1/4"	19.50
7886	1-1/2"	24.54
7887	2"	38.27
7888	2-1/2"	102.31

#### Threaded Tees - 2000# Forged Steel



Part #	Size	Price
7890	1/4"	8.17
7891	3/8"	9.12
7892	1/2"	7.84
7893	3/4"	10.62
7894	1"	14.75

### 2000# Forged Steel Fittings

#### Threaded Tees - 2000# Forged Steel (Continued)

Part #	Size	Price
7895	1-1/4"	26.10
7896	1-1/2"	31.59
7897	2"	39.49
31367	2-1/2"	100.11
31368	3"	172.55



### Carbon Steel Weld Fittings

#### Long Radius 90° Elbows - Standard Weld Carbon Steel

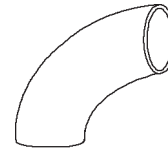

Part #	Size	Price
11309	1/2"	5.75
11310	3/4"	5.75
11311	1"	5.75
11312	1-1/4"	5.75
11313	1-1/2"	5.75
11314	2"	8.04
11315	2-1/2"	9.74
11316	3"	11.89
11317	3-1/2"	19.59
11318	4"	19.59
11319	5"	42.23
11320	6"	43.19
11321	8"	81.56
11322	10"	162.33
11323	12"	240.44
31937	14"	346.91
31938	16"	473.07
31939	18"	626.11
31940	20"	866.09
31941	24"	1224.82
31942	2" x 1"	147.73
31943	2" x 1-1/4"	659.76
31946	2-1/2" x 1-1/2"	191.49
31947	2-1/2" x 2"	151.10
31948	3" x 1-1/2"	169.43
31949	3" x 2"	156.71

Prices & specifications are subject to change.

Metropolitan Pipe offers FREE DELIVERY in the Greater Boston area.



## Steel Weld Fittings



### Carbon Steel Weld Fittings

#### Long Radius 90° Elbows - Standard Weld Carbon Steel (Continued)

Part #	Size	Price
31950	3" x 2-1/2"	275.27
31954	4" x 2"	268.16
31955	4" x 2-1/2"	268.16
31956	4" x 3"	177.28
31958	5" x 3"	524.35
31960	5" x 4"	315.29
31961	6" x 3"	547.54
31962	6" x 4"	344.08
31963	6" x 5"	344.08
31965	8" x 5"	3092.35
31966	8" x 6"	857.96
31967	10" x 5"	4777.55
31969	10" x 8"	4777.55
31971	12" x 8"	3250.44

#### Short Radius 90° Elbows - Standard Weld Carbon Steel

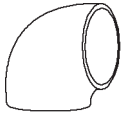

Part #	Size	Price
31973	1"	9.23
11359	1-1/4"	9.23
11360	1-1/2"	9.23
11361	2"	12.23
11362	2-1/2"	19.59
11363	3"	22.98
11364	4"	30.12
11365	5"	89.54
11366	6"	79.58
11367	8"	131.77
11368	10"	269.76
11369	12"	376.96
31986	14"	523.32
31987	16"	1537.67
31989	20"	1024.00
31990	24"	1575.85

### Long Radius 45° Elbow - Standard Weld Carbon Steel



Part #	Size	Price
11343	1/2"	6.11
11344	3/4"	6.11
11345	1"	6.11
11346	1-1/4"	6.11
11347	1-1/2"	6.11
11348	2"	7.85
11349	2-1/2"	9.40
11350	3"	9.74
11351	3-1/2"	17.55
11352	4"	17.55
11353	5"	26.61
11354	6"	34.53
11355	8"	57.51
11356	10"	114.79
11357	12"	162.33
32006	14"	218.25
32007	16"	391.11
32008	18"	553.09
32009	20"	572.56
32010	24"	867.68

### Straight Tees - Standard Weld Carbon Steel



Part #	Size	Price
11374	1/2"	18.93
11375	3/4"	18.93
11376	1"	18.93
11377	1-1/4"	18.93
11378	1-1/2"	18.93
11379	2"	19.36
11380	2-1/2"	26.72
11381	3"	29.78
11382	3-1/2"	41.78
11383	4"	41.78
11384	5"	68.95
11385	6"	71.77
11386	8"	125.20
11387	10"	245.98
11388	12"	344.24
32049	14"	603.92

### Carbon Steel Weld Fittings

#### Straight Tees - Standard Weld Carbon Steel (Continued)

Part #	Size	Price
32050	16"	675.13
164315	20"	1683.62
40452	24"	2172.97

#### Reducing Outlet Tees - Standard Weld Carbon Steel

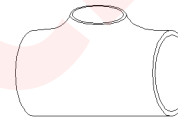

Part #	Size	Price
32053	1" x 1/2"	21.92
32054	1" x 3/4"	21.92
32057	1-1/4" x 1"	68.92
32059	1-1/2" x 3/4"	21.92
32061	1-1/2" x 1-1/4"	21.92
32063	2" x 1"	32.38
32064	2" x 1-1/4"	32.38
32065	2" x 1-1/2"	32.38
32066	2-1/2" x 1"	Call
32067	2-1/2" x 1-1/4"	35.55
32068	2-1/2" x 1-1/2"	35.55
32069	2-1/2" x 2"	35.55
32070	3" x 1"	84.09
32071	3" x 1-1/4"	Call
32072	3" x 1-1/2"	34.64
32073	3" x 2"	34.64
32074	3" x 2-1/2"	34.64
32079	4" x 1-1/2"	43.92
32080	4" x 2"	43.92
32081	4" x 2-1/2"	43.92
32082	4" x 3"	43.92
32084	5" x 2"	94.87
32085	5" x 2-1/2"	94.87
32086	5" x 3"	94.87
32088	5" x 4"	94.87
32089	6" x 2"	89.78
32090	6" x 2-1/2"	89.78
32091	6" x 3"	89.78
32093	6" x 4"	89.78
32094	6" x 5"	89.78
32095	8" x 3"	162.90
32097	8" x 4"	162.90
32098	8" x 5"	162.90





## Steel Weld Fittings



### Carbon Steel Weld Fittings

#### Reducing Outlet Tees - Standard Weld Carbon Steel (Continued)

Part #	Size	Price
32099	8" x 6"	162.90
49328	10" x 4"	300.55
118191	10" x 5"	729.56
32100	10" x 6"	300.55
32101	10" x 8"	300.55
32102	12" x 6"	443.63
32103	12" x 8"	443.63
32104	12" x 10"	443.63
814000	14" x 6"	669.13
49427	14" x 8"	669.13
132688	14" x 10"	669.13
132689	14" x 12"	669.13
57222	16" x 8"	1716.04
57221	16" x 10"	775.00
38484	16" x 12"	1716.04
134755	16" x 14"	1716.04
132680	18" x 14"	1353.39
55331	18" x 16"	1353.39

#### Concentric Reducers - Standard Weld Carbon Steel

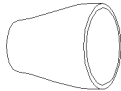

Part #	Size	Price
32105	3/4" x 1/2"	46.14
32106	1" x 1/2"	19.01
32107	1" x 3/4"	19.01
32109	1-1/4" x 3/4"	19.01
32110	1-1/4" x 1"	19.01
32111	1-1/2" x 1/2"	19.01
32112	1-1/2" x 3/4"	46.14
32113	1-1/2" x 1"	19.01
32114	1-1/2" x 1-1/4"	19.01
32115	2" x 3/4"	26.04
32116	2" x 1"	16.84
32117	2" x 1-1/4"	12.16
32118	2" x 1-1/2"	12.16
32119	2-1/2" x 1"	31.50
32120	2-1/2" x 1-1/4"	26.51
32121	2-1/2" x 1-1/2"	19.80
32122	2-1/2" x 2"	15.29
32123	3" x 1"	31.03
32124	3" x 1-1/4"	24.64

### Carbon Steel Weld Fittings

#### Concentric Reducers - Standard Weld Carbon Steel (Continued)

Part #	Size	Price
32125	3" x 1-1/2"	15.60
32126	3" x 2"	13.57
32127	3" x 2-1/2"	12.63
32130	3-1/2" x 2"	33.84
32131	3-1/2" x 2-1/2"	79.10
32132	3-1/2" x 3"	32.59
32133	4" x 1"	52.52
32135	4" x 1-1/2"	35.71
32136	4" x 2"	19.80
32137	4" x 2-1/2"	19.80
32138	4" x 3"	16.22
32139	4" x 3-1/2"	17.00
32140	5" x 2"	62.52
32141	5" x 2-1/2"	62.52
32142	5" x 3"	41.01
32143	5" x 3-1/2"	90.30
32144	5" x 4"	30.10
32145	6" x 2"	102.59
32146	6" x 2-1/2"	81.86
32147	6" x 3"	41.16
32149	6" x 4"	33.99
32150	6" x 5"	30.40
32151	8" x 3"	125.04
32153	8" x 4"	57.38
32154	8" x 5"	50.21
32155	8" x 6"	44.59
32156	10" x 4"	147.96
32157	10" x 5"	118.49
32158	10" x 6"	81.23
32159	10" x 8"	86.53
32162	12" x 6"	128.78
32163	12" x 8"	123.01
32164	12" x 10"	106.96
32166	14" x 8"	271.90
32167	14" x 10"	220.30
32168	14" x 12"	160.90
32170	16" x 8"	409.57
32171	16" x 10"	311.19
32172	16" x 12"	683.50
32173	16" x 14"	281.57
32176	18" x 14"	383.54
32177	18" x 16"	307.61
32179	20" x 14"	1334.06

### Carbon Steel Weld Fittings

#### Concentric Reducers - Standard Weld Carbon Steel (Continued)

Part #	Size	Price
32180	20" x 16"	527.90
32182	24" x 16"	637.19

#### Eccentric Reducers - Standard Weld Carbon Steel

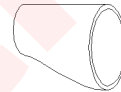

Part #	Size	Price
32185	1" x 1/2"	25.74
32186	1" x 3/4"	25.74
32188	1-1/4" x 3/4"	25.74
32189	1-1/4" x 1"	25.74
32191	1-1/2" x 3/4"	25.74
32192	1-1/2" x 1"	25.74
32193	1-1/2" x 1-1/4"	25.74
32194	2" x 3/4"	71.88
32195	2" x 1"	25.26
32196	2" x 1-1/4"	25.26
32197	2" x 1-1/2"	15.60
32199	2-1/2" x 1-1/4"	38.36
32200	2-1/2" x 1-1/2"	21.21
32201	2-1/2" x 2"	18.09
32202	3" x 1"	246.00
32203	3" x 1-1/4"	87.00
32204	3" x 1-1/2"	24.17
32205	3" x 2"	21.21
32206	3" x 2-1/2"	19.80
32210	3-1/2" x 2-1/2"	86.30
32211	3-1/2" x 3"	82.13
32212	4" x 1"	216.61
32214	4" x 1-1/2"	105.86
32215	4" x 2"	31.50
32216	4" x 2-1/2"	27.29
32217	4" x 3"	25.89
32219	5" x 2"	193.49
32220	5" x 2-1/2"	81.70
32221	5" x 3"	52.24
32223	5" x 4"	52.24
32224	6" x 2"	184.60
32225	6" x 2-1/2"	143.91
32226	6" x 3"	83.57
32228	6" x 4"	53.33
32229	6" x 5"	38.36

Prices & specifications are subject to change.

Metropolitan Pipe offers Vendor Managed Inventory - never run out of that part again!



## Steel Weld Fittings



### Carbon Steel Weld Fittings

**Eccentric Reducers -  
 Standard Weld Carbon Steel  
 (Continued)**

Part #	Size	Price
32230	8" x 3"	211.57
32232	8" x 4"	124.26
32233	8" x 5"	88.25
32234	8" x 6"	67.98
32235	10" x 4"	596.46
32236	10" x 5"	456.42
32237	10" x 6"	156.69
32238	10" x 8"	89.03
32241	12" x 6"	853.42
32242	12" x 8"	217.96
32243	12" x 10"	138.92
32244	14" x 10"	285.47

**Caps -  
 Standard Weld Carbon Steel**



Part #	Size	Price
11434	1/2"	7.07
11435	3/4"	7.07
11436	1"	7.07
11437	1-1/4"	7.07
11438	1-1/2"	7.07
11439	2"	7.82
11440	2-1/2"	8.23
11441	3"	8.23
32261	3-1/2"	12.00
11443	4"	12.00
11444	5"	18.47
11445	6"	20.49
11446	8"	31.00
11447	10"	56.20
11448	12"	84.77
32268	14"	112.80
32269	16"	112.80
32270	18"	180.04
32271	20"	204.30
32272	24"	277.74

### Short Radius 180° Return Bends - Standard Weld Carbon Steel

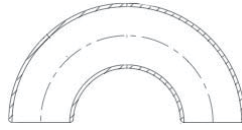

Part #	Size	Price
32024	1"	77.26
32025	1-1/4"	77.26
32026	1-1/2"	77.26
32029	3"	77.26
32031	4"	89.13

### Long Radius 90° Elbows - XH Weld Carbon Steel

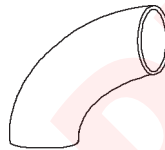

Part #	Size	Price
32285	1/2"	7.55
32286	3/4"	7.55
32287	1"	7.55
32289	1-1/2"	7.55
32290	2"	9.64
32291	2-1/2"	13.56
32292	3"	17.38
32294	4"	28.58
32295	5"	68.25
32296	6"	72.28
32297	8"	137.39
32298	10"	289.78
32299	12"	862.01
32300	14"	1194.95
32306	2-1/2" x 2"	182.14
32308	3" x 2"	572.13

### Short Radius 90° Elbows - XH Weld Carbon Steel



Part #	Size	Price
32321	1-1/4"	18.21
32322	1-1/2"	18.21
32323	2"	30.33
32324	2-1/2"	30.33
32325	3"	30.33
32326	3-1/2"	120.09

### Carbon Steel Weld Fittings

**Short Radius 90° Elbows -  
 XH Weld Carbon Steel  
 (Continued)**

Part #	Size	Price
32327	4"	49.86
32328	5"	111.99
32329	6"	116.16
32330	8"	248.50
32331	10"	909.40

### Long Radius 45° Elbow - XH Weld Carbon Steel

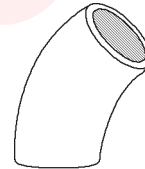

Part #	Size	Price
32334	3/4"	8.03
32335	1"	8.03
32336	1-1/4"	8.03
32337	1-1/2"	8.03
32338	2"	10.09
32339	2-1/2"	22.42
32340	3"	13.00
32342	4"	20.51
32343	5"	48.75
32344	6"	56.14
32345	8"	97.05
32346	10"	453.72
32347	12"	672.97

### Straight Tees - XH Weld Carbon Steel

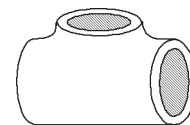

Part #	Size	Price
32365	3/4"	18.69
32367	1-1/4"	18.69
32368	1-1/2"	18.69
32369	2"	21.30
32370	2-1/2"	35.44
32371	3"	33.02
32373	4"	53.37
32374	5"	116.30
32375	6"	102.19



## Steel Weld Fittings



### Carbon Steel Weld Fittings

#### Straight Tees - XH Weld Carbon Steel (Continued)

Part #	Size	Price
32376	8"	202.25
32377	10"	731.78
32378	12"	1064.78

#### Reducing Outlet Tees - XH Weld Carbon Steel

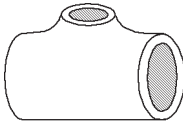

Part #	Size	Price
32388	1-1/2" x 1"	28.39
32389	1-1/2" x 1-1/4"	28.39
32396	2-1/2" x 1-1/2"	33.07
32397	2-1/2" x 2"	80.27
32400	3" x 1-1/2"	38.41
32401	3" x 2"	38.41
32402	3" x 2-1/2"	38.41
32407	4" x 1-1/2"	138.71
32408	4" x 2"	57.14
32409	4" x 2-1/2"	57.14
32410	4" x 3"	57.14
32415	5" x 4"	408.85
32416	6" x 3"	256.80
32417	6" x 4"	105.79

#### Concentric Reducers - XH Weld Carbon Steel

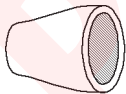

Part #	Size	Price
32423	1" x 3/4"	33.68
32424	1-1/4" x 1/2"	13.88
32426	1-1/4" x 1"	13.88
32427	1-1/2" x 1/2"	13.88
32428	1-1/2" x 3/4"	33.68
32429	1-1/2" x 1"	13.88
32432	2" x 1"	17.00
32433	2" x 1-1/4"	16.38
32434	2" x 1-1/2"	13.57
32436	2-1/2" x 1-1/4"	28.38
32437	2-1/2" x 1-1/2"	18.56
32438	2-1/2" x 2"	18.56
32439	3" x 1"	38.67

### Carbon Steel Weld Fittings

#### Concentric Reducers - XH Weld Carbon Steel (Continued)

Part #	Size	Price
32441	3" x 1-1/2"	20.74
32442	3" x 2"	15.60
32443	3" x 2-1/2"	15.60
32449	4" x 1"	63.45
32450	4" x 1-1/4"	63.45
32452	4" x 2"	26.20
32453	4" x 2-1/2"	23.54
32454	4" x 3"	19.96
32458	5" x 3"	150.25
32460	5" x 4"	42.57
32463	6" x 3"	55.98
32465	6" x 4"	47.87
32466	6" x 5"	46.47
32469	8" x 4"	79.52
32471	8" x 6"	65.18
32472	10" x 4"	245.72
32473	10" x 5"	188.03
32474	10" x 6"	111.48
32475	10" x 8"	93.39
32476	12" x 6"	404.57
32477	12" x 8"	376.19

#### Eccentric Reducers - XH Weld Carbon Steel

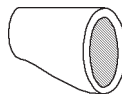

Part #	Size	Price
32481	1" x 1/2"	23.76
32485	1-1/4" x 1"	23.76
32486	1-1/2" x 1/2"	23.76
32488	1-1/2" x 1"	23.76
32489	1-1/2" x 1-1/4"	23.76
32491	2" x 1"	32.59
32494	2-1/2" x 1"	223.29
32496	2-1/2" x 1-1/2"	25.73
32497	2-1/2" x 2"	62.45
32501	3" x 2"	21.21
32502	3" x 2-1/2"	21.21
32510	4" x 1-1/2"	170.26
32511	4" x 2"	45.53
32512	4" x 2-1/2"	34.46
32513	4" x 3"	33.21
32515	5" x 2"	361.24

### Carbon Steel Weld Fittings

#### Eccentric Reducers - XH Weld Carbon Steel (Continued)

Part #	Size	Price
32517	5" x 3"	95.89
52006	5" x 4"	76.87
32520	6" x 2"	238.54
32521	6" x 2-1/2"	420.34
32522	6" x 3"	226.70
32524	6" x 4"	71.88
32529	8" x 5"	115.38
32530	8" x 6"	101.03

#### Caps - XH Weld Carbon Steel



Part #	Size	Price
32531	1/2"	8.75
32532	3/4"	8.75
32534	1-1/4"	8.75
32536	2"	7.82
32537	2-1/2"	10.79
32538	3"	12.00
32540	4"	16.31
32541	5"	26.69
32542	6"	33.15
32543	8"	49.73
32544	10"	76.41
32545	12"	102.15

Prices & specifications are subject to change.

Our faucet parts counter is one of the largest in the Boston area with thousands of parts in stock!



# Nipples

## Black Steel Nipples



### Standard Weight Std Wt Black Steel Nipples - 1/8"

Part#	Size	Price
3999	1/8" x Close	1.24
4000	1/8" x 1-1/2"	1.53
4001	1/8" x 2"	1.53
4002	1/8" x 2-1/2"	1.77
4003	1/8" x 3"	1.77
4004	1/8" x 3-1/2"	2.14
4005	1/8" x 4"	2.14
4006	1/8" x 4-1/2"	4.05
4007	1/8" x 5"	4.05
4008	1/8" x 5-1/2"	4.44
4009	1/8" x 6"	4.44
4010	1/8" x 7"	6.11
4011	1/8" x 8"	6.11
4012	1/8" x 9"	6.99
4013	1/8" x 10"	7.15
4014	1/8" x 11"	7.15
4015	1/8" x 12"	7.15

### Std Wt Black Steel Nipples - 1/4"

Part#	Size	Price
4017	1/4" x Close	1.49
4018	1/4" x 1-1/2"	1.58
4019	1/4" x 2"	1.58
4020	1/4" x 2-1/2"	2.04
4021	1/4" x 3"	2.04
4022	1/4" x 3-1/2"	2.36
4023	1/4" x 4"	2.36
4024	1/4" x 4-1/2"	3.58
4025	1/4" x 5"	3.58
4026	1/4" x 5-1/2"	4.21
4027	1/4" x 6"	4.21
4028	1/4" x 7"	6.47
4029	1/4" x 8"	6.47
4030	1/4" x 9"	7.61
4031	1/4" x 10"	7.61
4032	1/4" x 11"	8.39
4033	1/4" x 12"	8.39
131	1/4" x 24"	14.36



### Std Wt Black Steel Nipples - 1/4" (Continued)

Part#	Size	Price
132	1/4" x 30"	15.11
133	1/4" x 36"	21.27
134	1/4" x 48"	23.32
135	1/4" x 72"	30.69

### Std Wt Black Steel Nipples - 3/8"

Part#	Size	Price
4035	3/8" x Close	1.53
4036	3/8" x 1-1/2"	1.73
4037	3/8" x 2"	1.73
4038	3/8" x 2-1/2"	2.21
4039	3/8" x 3"	2.21
4040	3/8" x 3-1/2"	2.60
4041	3/8" x 4"	2.60
4042	3/8" x 4-1/2"	3.75
4043	3/8" x 5"	3.75
4044	3/8" x 5-1/2"	4.18
4045	3/8" x 6"	4.18
4046	3/8" x 7"	7.35
4047	3/8" x 8"	7.35
4048	3/8" x 9"	8.25
4049	3/8" x 10"	8.25
4050	3/8" x 11"	9.37
4051	3/8" x 12"	9.37
136	3/8" x 18"	12.64
137	3/8" x 24"	15.76
138	3/8" x 30"	16.76
139	3/8" x 36"	20.86
140	3/8" x 42"	23.70
141	3/8" x 48"	25.04
142	3/8" x 54"	30.24

### Std Wt Black Steel Nipples - 1/2"

Part#	Size	Price
4054	1/2" x Close	1.29
4055	1/2" x 1-1/2"	1.29
4056	1/2" x 2"	1.29
4057	1/2" x 2-1/2"	1.53
4058	1/2" x 3"	1.53
4059	1/2" x 3-1/2"	1.82

### Std Wt Black Steel Nipples - 1/2" (Continued)

Part#	Size	Price
4060	1/2" x 4"	1.82
4061	1/2" x 4-1/2"	2.14
4062	1/2" x 5"	2.14
4063	1/2" x 5-1/2"	2.38
4064	1/2" x 6"	2.38
4065	1/2" x 7"	4.29
4066	1/2" x 8"	4.29
4067	1/2" x 9"	5.16
4068	1/2" x 10"	5.16
4069	1/2" x 11"	6.13
4070	1/2" x 12"	6.13
146	1/2" x 18"	9.12
147	1/2" x 24"	11.90
148	1/2" x 30"	13.96
149	1/2" x 36"	16.46
150	1/2" x 42"	19.62
151	1/2" x 48"	20.81
152	1/2" x 54"	23.85
153	1/2" x 60"	24.95
154	1/2" x 66"	29.11
155	1/2" x 72"	30.68

### Std Wt Black Steel Nipples - 3/4"

Part#	Size	Price
4073	3/4" x Close	1.47
4074	3/4" x 1-1/2"	1.58
4075	3/4" x 2"	1.58
4076	3/4" x 2-1/2"	1.79
4077	3/4" x 3"	1.79
4078	3/4" x 3-1/2"	2.21
4079	3/4" x 4"	2.21
4080	3/4" x 4-1/2"	2.78
4081	3/4" x 5"	2.78
4082	3/4" x 5-1/2"	3.14
4083	3/4" x 6"	3.14
4084	3/4" x 7"	5.26
4085	3/4" x 8"	5.26
4086	3/4" x 9"	6.11
4087	3/4" x 10"	6.11
4088	3/4" x 11"	6.81
4089	3/4" x 12"	6.81

### Std Wt Black Steel Nipples - 3/4" (Continued)

Part#	Size	Price
156	3/4" x 18"	11.26
157	3/4" x 24"	14.41
158	3/4" x 30"	16.86
159	3/4" x 36"	19.97
160	3/4" x 42"	24.92
161	3/4" x 48"	26.58
162	3/4" x 54"	31.63
163	3/4" x 60"	32.55
164	3/4" x 66"	36.28
165	3/4" x 72"	37.45

### Std Wt Black Steel Nipples - 1"

Part#	Size	Price
4092	1" x Close	2.14
4093	1" x 2"	2.35
4094	1" x 2-1/2"	2.47
4095	1" x 3"	2.47
4096	1" x 3-1/2"	3.07
4097	1" x 4"	3.07
4098	1" x 4-1/2"	3.64
4099	1" x 5"	3.64
4100	1" x 5-1/2"	4.30
4101	1" x 6"	4.30
4102	1" x 7"	7.02
4103	1" x 8"	7.02
4104	1" x 9"	8.22
4105	1" x 10"	8.22
4106	1" x 11"	9.43
4107	1" x 12"	9.43
166	1" x 18"	14.48
167	1" x 24"	18.95
168	1" x 30"	21.83
169	1" x 36"	26.35
170	1" x 42"	32.97
171	1" x 48"	34.41
172	1" x 54"	41.80
173	1" x 60"	43.34
174	1" x 66"	47.37
175	1" x 72"	51.18



# Metropolitan Pipe & Supply

Plumbing • Heating • PVF • Industrial Supplies

## Nipples

### Black Steel Nipples



#### Std Wt Black Steel Nipples - 1-1/4"

Part#	Size	Price
4110	1-1/4" x Close	2.71
4111	1-1/4" x 2"	3.07
4112	1-1/4" x 2-1/2"	3.26
4113	1-1/4" x 3"	3.26
4114	1-1/4" x 3-1/2"	3.86
4115	1-1/4" x 4"	3.86
4116	1-1/4" x 4-1/2"	4.60
4117	1-1/4" x 5"	4.60
4118	1-1/4" x 5-1/2"	5.47
4119	1-1/4" x 6"	5.47
4120	1-1/4" x 7"	8.82
4121	1-1/4" x 8"	8.82
4122	1-1/4" x 9"	10.58
4123	1-1/4" x 10"	10.58
4124	1-1/4" x 11"	12.00
4125	1-1/4" x 12"	12.00
176	1-1/4" x 18"	18.43
177	1-1/4" x 24"	24.83
178	1-1/4" x 30"	29.33
179	1-1/4" x 36"	34.57
180	1-1/4" x 42"	42.70
181	1-1/4" x 48"	45.79
182	1-1/4" x 54"	54.45
183	1-1/4" x 60"	56.97
184	1-1/4" x 66"	64.06
185	1-1/4" x 72"	68.00

#### Std Wt Black Steel Nipples - 1-1/2"

Part#	Size	Price
4128	1-1/2" x Close	3.37
4129	1-1/2" x 2"	3.63
4130	1-1/2" x 2-1/2"	4.05
4131	1-1/2" x 3"	4.05
4132	1-1/2" x 3-1/2"	4.56
4133	1-1/2" x 4"	4.56
4134	1-1/2" x 4-1/2"	5.56
4135	1-1/2" x 5"	5.56
4136	1-1/2" x 5-1/2"	6.37
4137	1-1/2" x 6"	6.37
4138	1-1/2" x 7"	10.13
4139	1-1/2" x 8"	10.13
4140	1-1/2" x 9"	11.84

#### Std Wt Black Steel Nipples - 1-1/2" (Continued)

Part#	Size	Price
4141	1-1/2" x 10"	11.84
4142	1-1/2" x 11"	13.65
4143	1-1/2" x 12"	13.65
186	1-1/2" x 18"	21.05
187	1-1/2" x 24"	28.38
188	1-1/2" x 30"	33.81
189	1-1/2" x 36"	40.40
190	1-1/2" x 42"	47.52
191	1-1/2" x 48"	50.14
192	1-1/2" x 54"	65.23
193	1-1/2" x 60"	68.14
194	1-1/2" x 66"	77.94
195	1-1/2" x 72"	80.29

#### Std Wt Black Steel Nipples - 2"

Part#	Size	Price
4146	2" x Close	4.59
4147	2" x 2-1/2"	5.26
4148	2" x 3"	5.26
4149	2" x 3-1/2"	6.36
4150	2" x 4"	6.36
4151	2" x 4-1/2"	7.33
4152	2" x 5"	7.33
4153	2" x 5-1/2"	8.58
4154	2" x 6"	8.58
4155	2" x 7"	14.39
4156	2" x 8"	14.39
4157	2" x 9"	16.92
4158	2" x 10"	16.92
4159	2" x 11"	19.47
4160	2" x 12"	19.47
196	2" x 18"	29.33
197	2" x 24"	38.85
198	2" x 30"	44.66
199	2" x 36"	52.60
200	2" x 42"	67.38
201	2" x 48"	68.73
202	2" x 54"	83.22
203	2" x 60"	88.40
204	2" x 66"	92.41
205	2" x 72"	97.75

#### Std Wt Black Steel Nipples - 2-1/2"

Part#	Size	Price
4163	2-1/2" x Close	11.95
4164	2-1/2" x 3"	12.26
4165	2-1/2" x 3-1/2"	14.42
4166	2-1/2" x 4"	14.42
4167	2-1/2" x 4-1/2"	15.83
4168	2-1/2" x 5"	15.83
4169	2-1/2" x 5-1/2"	16.52
4170	2-1/2" x 6"	16.52
4171	2-1/2" x 7"	21.01
4172	2-1/2" x 8"	21.01
4173	2-1/2" x 9"	23.61
4174	2-1/2" x 10"	23.61
4175	2-1/2" x 11"	26.24
4176	2-1/2" x 12"	26.24
4179	2-1/2" x 18"	44.00
4181	2-1/2" x 22"	48.40
4182	2-1/2" x 24"	66.40

#### Std Wt Black Steel Nipples - 3"

Part#	Size	Price
4184	3" x Close	14.19
4185	3" x 3"	15.43
4186	3" x 3-1/2"	18.27
4187	3" x 4"	18.27
4188	3" x 4-1/2"	20.15
4189	3" x 5"	20.15
4190	3" x 5-1/2"	21.89
4191	3" x 6"	21.89
4192	3" x 7"	29.55
4193	3" x 8"	29.55
4194	3" x 9"	33.19
4195	3" x 10"	33.19
4196	3" x 11"	36.82
4197	3" x 12"	36.82
4200	3" x 18"	80.97

#### Std Wt Black Steel Nipples - 3-1/2"

Part#	Size	Price
4205	3-1/2" x Close	26.01
4206	3-1/2" x 4"	32.42
4207	3-1/2" x 4-1/2"	37.34

#### Std Wt Black Steel Nipples - 3-1/2" (Continued)

Part#	Size	Price
4208	3-1/2" x 5"	15.76
4209	3-1/2" x 5-1/2"	41.96
4210	3-1/2" x 6"	27.34
4211	3-1/2" x 7"	47.63
4212	3-1/2" x 8"	47.63
4214	3-1/2" x 10"	52.34
4215	3-1/2" x 11"	58.98
4216	3-1/2" x 12"	58.98

#### Std Wt Black Steel Nipples - 4"

Part#	Size	Price
4218	4" x Close	21.37
4219	4" x 4"	24.72
4220	4" x 4-1/2"	28.24
4221	4" x 5"	28.24
4222	4" x 5-1/2"	30.19
4223	4" x 6"	30.19
4224	4" x 7"	34.86
4225	4" x 8"	34.86
4226	4" x 9"	39.69
4227	4" x 10"	39.69
4228	4" x 11"	46.52
4229	4" x 12"	46.52
4231	4" x 16"	82.12
4232	4" x 18"	96.84
4233	4" x 20"	96.84
4235	4" x 24"	113.50

#### Std Wt Black Steel Nipples - 5"

Part#	Size	Price
4236	5" x Close	69.54
4237	5" x 4-1/2"	81.53
4238	5" x 5"	81.53
4239	5" x 5-1/2"	89.44
4240	5" x 6"	89.44
4241	5" x 8"	106.56
4242	5" x 10"	122.13
4243	5" x 12"	142.41

Prices & specifications are subject to change.

Our office hours are 7am to 4:30pm and counter hours 6am to 4:30pm Monday through Friday.



# Nipples

## Black Steel Nipples



### Std Wt Black Steel Nipples - 6"

Part#	Size	Price
4245	6" x Close	78.17
4246	6" x 4-1/2"	92.00
4247	6" x 5"	92.00
4248	6" x 5-1/2"	102.03
4249	6" x 6"	102.03
4250	6" x 8"	122.97
4251	6" x 10"	142.41
4252	6" x 12"	167.64

### Extra-Heavy A53 XH A53 Black Steel Nipples - 1/8"

Part#	Size	Price
4261	1/8" x Close	2.14
4262	1/8" x 1-1/2"	2.44
4263	1/8" x 2"	2.44
4264	1/8" x 2-1/2"	2.83
4265	1/8" x 3"	2.83
4266	1/8" x 3-1/2"	3.66
4267	1/8" x 4"	3.66
4268	1/8" x 4-1/2"	6.69
4269	1/8" x 5"	6.69
4270	1/8" x 5-1/2"	7.29
4271	1/8" x 6"	7.29

### XH A53 Black Steel Nipples - 1/4"

Part#	Size	Price
4273	1/4" x Close	2.27
4274	1/4" x 1-1/2"	2.65
4275	1/4" x 2"	2.65
4276	1/4" x 2-1/2"	3.44
4277	1/4" x 3"	3.44
4278	1/4" x 3-1/2"	3.75
4279	1/4" x 4"	3.75
4280	1/4" x 4-1/2"	5.93
4281	1/4" x 5"	5.93
4282	1/4" x 5-1/2"	6.73
4283	1/4" x 6"	6.73
4273	1/4" x 12"	2.27

### XH A53 Black Steel Nipples - 3/8"

Part#	Size	Price
4285	3/8" x Close	2.32
4286	3/8" x 1-1/2"	2.94
4287	3/8" x 2"	2.94
4288	3/8" x 2-1/2"	3.49
4289	3/8" x 3"	3.49
4290	3/8" x 3-1/2"	4.13
4291	3/8" x 4"	4.13
4292	3/8" x 4-1/2"	5.93
4293	3/8" x 5"	5.93
4294	3/8" x 5-1/2"	6.74
4295	3/8" x 6"	6.74

### XH A53 Black Steel Nipples - 1/2"

Part#	Size	Price
4297	1/2" x Close	2.14
4298	1/2" x 1-1/2"	2.15
4299	1/2" x 2"	2.15
4300	1/2" x 2-1/2"	2.57
4301	1/2" x 3"	2.57
4302	1/2" x 3-1/2"	3.07
4303	1/2" x 4"	3.07
4304	1/2" x 4-1/2"	3.50
4305	1/2" x 5"	3.50
4306	1/2" x 5-1/2"	3.98
4307	1/2" x 6"	3.98

### XH A53 Black Steel Nipples - 3/4"

Part#	Size	Price
4309	3/4" x Close	2.46
4310	3/4" x 1-1/2"	2.47
4311	3/4" x 2"	2.47
4312	3/4" x 2-1/2"	2.96
4313	3/4" x 3"	2.96
4314	3/4" x 3-1/2"	3.50
4315	3/4" x 4"	3.50
4316	3/4" x 4-1/2"	4.36
4317	3/4" x 5"	4.36
4318	3/4" x 5-1/2"	5.19
4319	3/4" x 6"	5.19

### XH A53 Black Steel Nipples - 1"

Part#	Size	Price
4321	1" x Close	3.64
4322	1" x 2"	4.07
4323	1" x 2-1/2"	4.21
4324	1" x 3"	4.21
4325	1" x 3-1/2"	5.04
4326	1" x 4"	5.04
4327	1" x 4-1/2"	6.00
4328	1" x 5"	6.00
4329	1" x 5-1/2"	7.10
4330	1" x 6"	7.10

### XH A53 Black Steel Nipples - 1-1/4"

Part#	Size	Price
4332	1-1/4" x Close	4.46
4333	1-1/4" x 2"	4.79
4334	1-1/4" x 2-1/2"	5.26
4335	1-1/4" x 3"	5.26
4336	1-1/4" x 3-1/2"	6.57
4337	1-1/4" x 4"	6.57
4338	1-1/4" x 4-1/2"	8.08
4339	1-1/4" x 5"	8.08
4340	1-1/4" x 5-1/2"	9.10
4341	1-1/4" x 6"	9.10

### XH A53 Black Steel Nipples - 1-1/2"

Part#	Size	Price
4343	1-1/2" x Close	5.59
4344	1-1/2" x 2"	6.05
4345	1-1/2" x 2-1/2"	6.50
4346	1-1/2" x 3"	6.50
4347	1-1/2" x 3-1/2"	7.84
4348	1-1/2" x 4"	7.84
4349	1-1/2" x 4-1/2"	9.13
4350	1-1/2" x 5"	9.13
4351	1-1/2" x 5-1/2"	10.47
4352	1-1/2" x 6"	10.47

### XH A53 Black Steel Nipples - 2"

Part#	Size	Price
4354	2" x Close	7.66
4355	2" x 2-1/2"	8.63

### XH A53 Black Steel Nipples - 2" (Continued)

Part#	Size	Price
4356	2" x 3"	8.63
4357	2" x 3-1/2"	9.92
4358	2" x 4"	9.92
4359	2" x 4-1/2"	12.26
4360	2" x 5"	12.26
4361	2" x 5-1/2"	14.13
4362	2" x 6"	14.13

### XH A53 Black Steel Nipples - 2-1/2"

Part#	Size	Price
4364	2-1/2" x Close	23.43
4365	2-1/2" x 3"	24.40
4366	2-1/2" x 3-1/2"	28.45
4367	2-1/2" x 4"	28.45
4368	2-1/2" x 4-1/2"	32.31
4369	2-1/2" x 5"	32.31
4370	2-1/2" x 5-1/2"	35.21
4371	2-1/2" x 6"	35.21

### XH A53 Black Steel Nipples - 3"

Part#	Size	Price
4373	3" x Close	28.60
4374	3" x 3"	31.82
4375	3" x 3-1/2"	37.11
4376	3" x 4"	37.11
4377	3" x 4-1/2"	40.73
4378	3" x 5"	40.73
4379	3" x 5-1/2"	44.48
4380	3" x 6"	44.48

### XH A53 Black Steel Nipples - 4"

Part#	Size	Price
4382	4" x Close	43.13
4383	4" x 4"	49.01
4384	4" x 4-1/2"	55.04
4385	4" x 5"	55.04
4386	4" x 5-1/2"	59.82
4387	4" x 6"	59.82

Pipe, Fittings, Hardware

Prices & specifications are subject to change.

Metropolitan Pipe offers FREE DELIVERY in the Greater Boston area.



# Nipples

## Black Steel Nipples



### Extra-Heavy A106 Seamless

#### XH A106 Smls Black Steel Nipples - 1/4"

Part#	Size	Price
31211	1/4" x Close	5.84
31212	1/4" x 1-1/2"	5.97
31213	1/4" x 2"	6.60
31214	1/4" x 2-1/2"	7.19
31215	1/4" x 3"	7.99
31216	1/4" x 3-1/2"	8.88
31217	1/4" x 4"	9.84
31218	1/4" x 4-1/2"	10.69
31219	1/4" x 5"	15.17
31220	1/4" x 5-1/2"	16.01
31221	1/4" x 6"	17.08

#### XH A106 Smls Black Steel Nipples - 3/8"

Part#	Size	Price
31222	3/8" x Close	6.31
31223	3/8" x 1-1/2"	6.58
31224	3/8" x 2"	7.19
31225	3/8" x 2-1/2"	8.08
31226	3/8" x 3"	9.08
31227	3/8" x 3-1/2"	9.99
31228	3/8" x 4"	10.87
31229	3/8" x 4-1/2"	11.95
31230	3/8" x 5"	15.92
31231	3/8" x 5-1/2"	17.02
31232	3/8" x 6"	18.12

#### XH A106 Smls Black Steel Nipples - 1/2"

Part#	Size	Price
31233	1/2" x Close	3.22
31234	1/2" x 1-1/2"	3.42
31235	1/2" x 2"	3.76
31236	1/2" x 2-1/2"	4.16
31237	1/2" x 3"	4.58
31238	1/2" x 3-1/2"	5.19
31239	1/2" x 4"	5.71
31240	1/2" x 4-1/2"	6.28
31241	1/2" x 5"	7.23
31242	1/2" x 5-1/2"	7.87
31243	1/2" x 6"	8.51

### XH A106 Smls Black Steel Nipples - 3/4"

Part#	Size	Price
31244	3/4" x Close	3.63
31245	3/4" x 1-1/2"	3.88
31246	3/4" x 2"	4.06
31247	3/4" x 2-1/2"	4.60
31248	3/4" x 3"	5.11
31249	3/4" x 3-1/2"	5.83
31250	3/4" x 4"	6.39
31251	3/4" x 4-1/2"	6.98
31252	3/4" x 5"	7.97
31253	3/4" x 5-1/2"	8.56
31254	3/4" x 6"	9.20

### XH A106 Smls Black Steel Nipples - 1"

Part#	Size	Price
31255	1" x Close	5.13
31256	1" x 2"	5.44
34431	1" x 2-1/2"	5.83
34432	1" x 3"	6.81
34433	1" x 3-1/2"	7.55
34434	1" x 4"	8.44
34435	1" x 4-1/2"	9.18
34436	1" x 5"	10.62
34437	1" x 5-1/2"	11.37
34438	1" x 6"	12.13

### XH A106 Smls Black Steel Nipples - 1-1/4"

Part#	Size	Price
34439	1-1/4" x Close	6.44
34440	1-1/4" x 2"	6.69
34441	1-1/4" x 2-1/2"	7.37
34442	1-1/4" x 3"	8.56
34443	1-1/4" x 3-1/2"	9.35
34444	1-1/4" x 4"	10.47
34445	1-1/4" x 4-1/2"	11.38
34446	1-1/4" x 5"	13.19
34447	1-1/4" x 5-1/2"	14.19
34448	1-1/4" x 6"	15.17

### XH A106 Smls Black Steel Nipples - 1-1/2"

Part#	Size	Price
34449	1-1/2" x Close	7.75

### Extra-Heavy A106 Seamless

#### XH A106 Smls Black Steel Nipples - 1-1/2" (Continued)

Part#	Size	Price
34450	1-1/2" x 2"	8.19
34451	1-1/2" x 2-1/2"	8.91
34452	1-1/2" x 3"	10.25
34453	1-1/2" x 3-1/2"	11.19
34454	1-1/2" x 4"	12.52
34455	1-1/2" x 4-1/2"	13.70
34456	1-1/2" x 5"	15.83
34457	1-1/2" x 5-1/2"	16.83
34458	1-1/2" x 6"	17.80

#### XH A106 Smls Black Steel Nipples - 2"

Part#	Size	Price
34459	2" x Close	9.20
34460	2" x 2-1/2"	10.33
34461	2" x 3"	12.01
34462	2" x 3-1/2"	12.92
34463	2" x 4"	14.42
34464	2" x 4-1/2"	15.55
34465	2" x 5"	18.21
34466	2" x 5-1/2"	19.66
34467	2" x 6"	20.79

#### XH A106 Smls Black Steel Nipples - 2-1/2"

Part#	Size	Price
42882	2-1/2" x Close	30.56
49308	2-1/2" x 3"	32.00
49309	2-1/2" x 3-1/2"	34.45
49310	2-1/2" x 4"	35.73
49311	2-1/2" x 4-1/2"	37.67
49312	2-1/2" x 5"	40.22
49313	2-1/2" x 5-1/2"	42.23
49314	2-1/2" x 6"	44.04

## Galvanized Steel Nipples

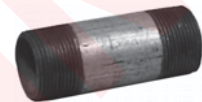

### Galvanized Steel Galv Steel Nipples - 1/8"

Part #	Size	Price
4398	1/8" x Close	1.56
4399	1/8" x 1-1/2"	2.16
4400	1/8" x 2"	2.16
4401	1/8" x 2-1/2"	2.84
4402	1/8" x 3"	2.84
4403	1/8" x 3-1/2"	3.37
4404	1/8" x 4"	3.37
4405	1/8" x 4-1/2"	5.68
4406	1/8" x 5"	5.68
4407	1/8" x 5-1/2"	6.36
4408	1/8" x 6"	6.36

### Galv Steel Nipples - 1/4"

Part #	Size	Price
4409	1/4" x Close	1.67
4410	1/4" x 1-1/2"	1.94
4411	1/4" x 2"	1.94
4412	1/4" x 2-1/2"	2.55
4413	1/4" x 3"	2.55
4414	1/4" x 3-1/2"	3.07
4415	1/4" x 4"	3.07
4416	1/4" x 4-1/2"	4.18
4417	1/4" x 5"	4.18
4418	1/4" x 5-1/2"	4.66
4419	1/4" x 6"	4.66

### Galv Steel Nipples - 3/8"

Part #	Size	Price
4420	3/8" x Close	1.81
4421	3/8" x 1-1/2"	2.09
4422	3/8" x 2"	2.09
4423	3/8" x 2-1/2"	2.79
4424	3/8" x 3"	2.79

Prices & specifications are subject to change.

You can check stock availability, pricing and place orders online at [www.MetPipe.com](http://www.MetPipe.com).



# Metropolitan Pipe & Supply

Plumbing • Heating • PVF • Industrial Supplies

## Nipples

### Galv Steel Nipples - 3/8" (Continued)

Part #	Size	Price
4425	3/8" x 3-1/2"	3.31
4426	3/8" x 4"	3.31
4427	3/8" x 4-1/2"	4.56
4428	3/8" x 5"	4.56
4429	3/8" x 5-1/2"	5.06
4430	3/8" x 6"	5.06

### Galv Steel Nipples - 1/2"

Part #	Size	Price
4431	1/2" x Close	1.47
4432	1/2" x 1-1/2"	1.56
4433	1/2" x 2"	1.56
4434	1/2" x 2-1/2"	1.82
4435	1/2" x 3"	1.82
4436	1/2" x 3-1/2"	2.26
4437	1/2" x 4"	2.26
4438	1/2" x 4-1/2"	2.71
4439	1/2" x 5"	2.90
4440	1/2" x 5-1/2"	3.07
4441	1/2" x 6"	3.07
4443	1/2" x 8"	5.39
4444	1/2" x 10"	6.41
4445	1/2" x 12"	7.30

### Galv Steel Nipples - 3/4"

Part #	Size	Price
4446	3/4" x Close	1.79
4447	3/4" x 1-1/2"	1.94
4448	3/4" x 2"	1.94
4449	3/4" x 2-1/2"	2.15
4450	3/4" x 3"	2.15
4451	3/4" x 3-1/2"	2.78
4452	3/4" x 4"	2.78
4453	3/4" x 4-1/2"	3.31
4454	3/4" x 5"	3.31
4455	3/4" x 5-1/2"	3.98
4456	3/4" x 6"	3.98
4457	3/4" x 8"	6.91
4458	3/4" x 10"	7.66
4459	3/4" x 12"	8.58

### Galv Steel Nipples- 1"

Part #	Size	Price
4460	1" x Close	2.46
4461	1" x 2"	2.89
4462	1" x 2-1/2"	3.12

### Galv Steel Nipples- 1" (Continued)

Part #	Size	Price
4463	1" x 3"	3.12
4464	1" x 3-1/2"	3.75
4465	1" x 4"	3.75
4466	1" x 4-1/2"	4.60
4467	1" x 5"	4.60
4468	1" x 5-1/2"	5.24
4469	1" x 6"	5.24
4470	1" x 8"	8.75
4471	1" x 10"	10.00
4472	1" x 12"	11.63

### Galv Steel Nipples - 1-1/4"

Part #	Size	Price
4473	1-1/4" x Close	3.29
4474	1-1/4" x 2"	3.57
4475	1-1/4" x 2-1/2"	3.87
4476	1-1/4" x 3"	3.87
4477	1-1/4" x 3-1/2"	4.60
4478	1-1/4" x 4"	4.60
4479	1-1/4" x 4-1/2"	5.69
4480	1-1/4" x 5"	5.69
4481	1-1/4" x 5-1/2"	6.62
4482	1-1/4" x 6"	6.62
4483	1-1/4" x 8"	10.72
4484	1-1/4" x 10"	12.82
4485	1-1/4" x 12"	15.39

### Galv Steel Nipples - 1-1/2"

Part #	Size	Price
4486	1-1/2" x Close	3.86
4487	1-1/2" x 2"	4.14
4488	1-1/2" x 2-1/2"	4.60
4489	1-1/2" x 3"	4.60
4490	1-1/2" x 3-1/2"	5.83
4491	1-1/2" x 4"	5.83
4492	1-1/2" x 4-1/2"	7.04
4493	1-1/2" x 5"	7.04
4494	1-1/2" x 5-1/2"	7.92
4495	1-1/2" x 6"	7.92
4496	1-1/2" x 8"	12.30
4497	1-1/2" x 10"	14.34
4498	1-1/2" x 12"	16.39

### Galv Steel Nipples - 2"

Part #	Size	Price
4499	2" x Close	5.42

### Galv Steel Nipples - 2" (Continued)

Part #	Size	Price
4500	2" x 2-1/2"	6.11
4501	2" x 3"	6.11
4502	2" x 3-1/2"	7.42
4503	2" x 4"	7.42
4504	2" x 4-1/2"	9.48
4505	2" x 5"	9.48
4506	2" x 5-1/2"	11.00
4507	2" x 6"	11.00
4508	2" x 8"	17.94
4509	2" x 10	20.99
4510	2" x 12"	24.07

### Galv Steel Nipples - 2-1/2"

Part #	Size	Price
4511	2-1/2" x Close	13.46
4512	2-1/2" x 3"	13.98
4513	2-1/2" x 3-1/2"	16.24
4514	2-1/2" x 4"	16.24
4515	2-1/2" x 4-1/2"	18.10
4516	2-1/2" x 5"	18.10
4517	2-1/2" x 5-1/2"	19.88
4518	2-1/2" x 6"	19.88
4519	2-1/2" x 8"	25.59
4520	2-1/2" x 10"	29.18
4521	2-1/2" x 12"	32.65

### Galv Steel Nipples - 3"

Part #	Size	Price
4522	3" x Close	16.14
4523	3" x 3"	18.37
4524	3" x 3-1/2"	21.55
4525	3" x 4"	21.55
4526	3" x 4-1/2"	25.11
4527	3" x 5"	25.11
4528	3" x 5-1/2"	26.56
4529	3" x 6"	26.56
4530	3" x 8"	35.77
4531	3" x 10"	40.81
4532	3" x 12"	45.88

### Galv Steel Nipples - 4"

Part #	Size	Price
4533	4" x Close	24.19
4535	4" x 4"	28.92
4536	4" x 4-1/2"	32.43
4537	4" x 5"	32.43
4538	4" x 5-1/2"	43.02

### Galv Steel Nipples - 4" (Continued)

Part #	Size	Price
4539	4" x 6"	43.02
4540	4" x 8"	42.78
4541	4" x 10"	49.58
4542	4" x 12"	56.44

### Galv Steel Nipples - 5"

Part #	Size	Price
4543	5" x Close	139.13
4544	5" x 6"	178.79

### Galv Steel Nipples - 6"

Part #	Size	Price
4546	6" x Close	156.29
4547	6" x 6"	204.05





# Metropolitan Pipe & Supply

Plumbing • Heating • PVF • Industrial Supplies

## Pipe



### Stainless Steel Pipe

Sch 40 304 Welded - 20' Lengths

Part #	Size	Price
10639	1/2"	9.38
10640	3/4"	12.37
10641	1"	17.25
10642	1-1/4"	22.93
42984	1-1/2"	26.76
43855	2"	36.00

Sch 40 316 Welded - 20' Lengths

Part #	Size	Price
10843	3/4"	17.56
10844	1"	24.64
10845	1-1/4"	31.90
10846	1-1/2"	37.01
10847	2"	49.47

### 304/SS Stainless Steel Fittings

Threaded 150# Hex Bushings - 304/SS



Part #	Size	Price
10752	1/4" x 1/8"	5.11
10753	3/8" x 1/8"	5.58
10754	3/8" x 1/4"	5.58
10755	1/2" x 1/8"	7.06
10756	1/2" x 1/4"	7.06
10757	1/2" x 3/8"	7.06
10759	3/4" x 1/4"	3.31
10760	3/4" x 3/8"	3.31
10761	3/4" x 1/2"	3.31
10762	1" x 1/4"	4.60
10763	1" x 3/8"	4.60
10764	1" x 1/2"	4.60
10765	1" x 3/4"	4.60
10766	1-1/4" x 1/2"	8.23
10767	1-1/4" x 3/4"	8.23
10768	1-1/4" x 1"	8.23
10770	1-1/2" x 1/2"	9.85
10771	1-1/2" x 3/4"	9.85
10773	1-1/2" x 1-1/4"	9.85

Threaded 150# Hex Bushings - 304/SS (Continued)

Part #	Size	Price
10774	2" x 1/2"	15.02
10775	2" x 3/4"	15.02
10776	2" x 1"	15.02
10777	2" x 1-1/4"	15.02
10778	2" x 1-1/2"	15.02

Threaded 150# Couplings - 304/SS



Part #	Size	Price
10732	1/4"	5.07
10733	3/8"	5.91
10734	1/2"	8.37
10735	3/4"	3.87
10736	1"	5.89
10737	1-1/4"	9.35
10738	1-1/2"	11.10
10739	2"	15.65

Threaded 150# Reducing Couplings - 304/SS



Part #	Size	Price
10742	3/8" x 1/4"	2.92
10743	1/2" x 1/4"	2.79
10744	1/2" x 3/8"	2.79
10746	3/4" x 1/4"	4.19
10747	3/4" x 1/2"	4.19
10750	1" x 1/2"	5.73
10751	1" x 3/4"	5.73
134836	2" x 1-1/4"	17.79

Threaded 150# Caps - 304/SS



Part #	Size	Price
10834	1/4"	1.82

Threaded 150# Caps - 304/SS (Continued)

Part #	Size	Price
10835	3/8"	2.13
10836	1/2"	2.21
10837	3/4"	2.77
10838	1"	4.16
10839	1-1/4"	7.53
10840	1-1/2"	9.88
10841	2"	12.59

Threaded 150# 45° Elbows - 304/SS



Part #	Size	Price
10807	1/4"	3.18
10808	3/8"	3.73
10809	1/2"	4.10
10810	3/4"	5.99
10811	1"	7.31
10812	1-1/4"	11.70
10813	1-1/2"	13.92
10814	2"	19.58

Threaded 150# 90° Elbows - 304/SS



Part #	Size	Price
10789	1/4"	2.52
10790	3/8"	3.12
10791	1/2"	3.32
10792	3/4"	4.77
10793	1"	6.75
10794	1-1/4"	11.85
10795	1-1/2"	15.77
10796	2"	20.00

Prices & specifications are subject to change.

We offer a variety of GREEN products such as flush valves, faucets, showerheads & more!

1-800-MetPipe  
www.MetPipe.com

465

Pipe, Fittings, Hardware



## Stainless Steel Fittings



### Threaded 150# 90° Street Elbows - 304/SS



Part #	Size	Price
10797	1/8"	3.59
10798	1/4"	3.59
10799	3/8"	4.32
10800	1/2"	5.08
10801	3/4"	7.05
10802	1"	12.20
10803	1-1/4"	17.71
10804	1-1/2"	20.95
10805	2"	28.38

### Threaded 150# Square Headed Plugs Cored - 304/SS



Part #	Size	Price
10824	1/8"	1.09
10825	1/4"	1.29
10826	3/8"	1.72
10827	1/2"	2.45
10828	3/4"	2.99
10829	1"	3.78
10830	1-1/4"	7.53
10831	1-1/2"	8.98
10832	2"	10.62

### Threaded 150# Tees - 304/SS



Part #	Size	Price
10816	1/4"	3.37
10817	3/8"	4.29
10818	1/2"	4.51
10819	3/4"	7.17
10820	1"	9.13
10821	1-1/4"	18.15
10822	1-1/2"	22.56
10823	2"	28.97

### Threaded 150# Unions - 304/SS



Part #	Size	Price
10780	1/4"	26.44
10781	3/8"	26.95
10782	1/2"	9.35
10783	3/4"	11.85
10784	1"	17.87
10785	1-1/4"	30.99
10786	1-1/2"	35.06
10787	2"	41.97

### 316/SS Stainless Steel Fittings

#### Threaded 150# Hex Bushings - 316/SS



Part #	Size	Price
10965	1/4" x 1/8"	5.76
10967	3/8" x 1/4"	6.57
10968	1/2" x 1/4"	7.72
10969	1/2" x 3/8"	7.72
10970	3/4" x 1/4"	3.68
10971	3/4" x 3/8"	3.68
10972	3/4" x 1/2"	3.68
10975	1" x 1/2"	5.26
10976	1" x 3/4"	5.26
10978	1-1/4" x 1/2"	10.27
10979	1-1/4" x 3/4"	10.27
10980	1-1/4" x 1"	10.27
10983	1-1/2" x 1/2"	12.14
10984	1-1/2" x 3/4"	12.14
10985	1-1/2" x 1"	12.14
10986	1-1/2" x 1-1/4"	12.14
10987	2" x 1"	17.24
10988	2" x 1-1/4"	17.24

### Threaded 150# Couplings - 316/SS



Part #	Size	Price
10939	1/4"	5.65
10940	3/8"	6.63
10941	1/2"	9.68
10942	3/4"	4.49
10943	1"	6.68
10944	1-1/4"	10.63
10945	1-1/2"	12.63
10946	2"	17.77

### Threaded 150# 45° Elbows - 316/SS



Part #	Size	Price
11000	1/4"	3.84
11001	3/8"	4.68
11002	1/2"	5.14
11003	3/4"	6.75
11004	1"	8.46
11005	1-1/4"	13.30
11006	1-1/2"	15.82
11007	2"	22.11

### Threaded 150# 90° Elbows - 316/SS



Part #	Size	Price
10991	1/4"	3.22
10992	3/8"	3.91
10993	1/2"	4.32
10994	3/4"	6.26
10995	1"	7.86
10996	1-1/4"	13.47
10997	1-1/2"	17.97
10998	2"	22.71

Pipe, Fittings, Hardware

Prices & specifications are subject to change.



## Stainless Steel Fittings



### Threaded 150# 90° Street Elbows - 316/SS



Part #	Size	Price
11008	1/4"	4.40
11009	3/8"	5.40
11010	1/2"	6.36
11011	3/4"	8.37
11012	1"	13.37
11013	1-1/4"	19.98
11014	1-1/2"	22.26
11015	2"	31.79

### Threaded 150# Square Headed Plugs Cored - 316/SS



Part #	Size	Price
11025	1/4"	1.49
11026	3/8"	1.96
11027	1/2"	2.77
11028	3/4"	3.39
11029	1"	4.23
11030	1-1/4"	10.00
11031	1-1/2"	11.05
11032	2"	15.24

### Threaded 150# Reducers - 316/SS



Part #	Size	Price
10947	1/4" x 1/8"	2.99
10949	3/8" x 1/4"	3.32
10950	1/2" x 1/4"	3.98
10951	1/2" x 3/8"	3.98
10952	3/4" x 1/4"	5.11
10953	3/4" x 3/8"	5.11
10954	3/4" x 1/2"	5.11
10956	1" x 1/2"	8.42
10957	1" x 3/4"	8.42

### Threaded 150# Reducers - 316/SS (Continued)

Part #	Size	Price
10958	1-1/4" x 3/4"	11.00
10960	1-1/2" x 1"	14.69
10961	1-1/2" x 1-1/4"	14.69
10964	2" x 1-1/2"	24.77

### Threaded 150# Tees - 316/SS



Part #	Size	Price
11016	1/4"	4.01
11017	3/8"	5.31
11018	1/2"	5.60
11019	3/4"	8.25
11020	1"	10.35
11021	1-1/4"	20.61
11022	1-1/2"	25.00
11023	2"	32.21

### Threaded 150# Unions - 316/SS



Part #	Size	Price
10931	1/4"	30.00
10932	3/8"	30.52
10933	1/2"	10.63
10934	3/4"	13.48
10935	1"	20.34
10936	1-1/4"	35.16
10937	1-1/2"	39.91
10938	2"	47.59

Prices & specifications are subject to change.

Our state of the art pipe shop offers cutting, threading, grooving and make-ons up to 36in!



**Nipples**



**Stainless Steel  
 304/SS Weld Sch 40 - 1/8"**

Part #	Size	Price
10643	1/8" x Close	1.15
33971	1/8" x 1-1/2"	1.50
10644	1/8" x 2"	1.79
33972	1/8" x 2-1/2"	2.07
10645	1/8" x 3"	2.35
10646	1/8" x 4"	2.93
10647	1/8" x 5"	3.51
10648	1/8" x 6"	4.08

**304/SS Weld Sch 40 - 1/4"**

Part #	Size	Price
10649	1/4" x Close	1.29
10650	1/4" x 1-1/2"	1.60
10651	1/4" x 2"	1.92
10652	1/4" x 2-1/2"	2.28
10653	1/4" x 3"	2.63
10654	1/4" x 3-1/2"	2.98
10655	1/4" x 4"	3.37
10656	1/4" x 4-1/2"	3.72
10657	1/4" x 5"	4.07
10658	1/4" x 5-1/2"	4.43
10659	1/4" x 6"	4.78

**304/SS Weld Sch 40 - 3/8"**

Part #	Size	Price
10660	3/8" x Close	1.55
10661	3/8" x 1-1/2"	1.88
10662	3/8" x 2"	2.28
10663	3/8" x 2-1/2"	2.71
10664	3/8" x 3"	3.14
10665	3/8" x 3-1/2"	3.58
10666	3/8" x 4"	4.01
10667	3/8" x 4-1/2"	4.44
10668	3/8" x 5"	4.87
10669	3/8" x 5-1/2"	5.31
10670	3/8" x 6"	5.74

**304/SS Weld Sch 40 - 1/2"**

Part #	Size	Price
10671	1/2" x Close	2.00
10672	1/2" x 1-1/2"	2.41
10673	1/2" x 2"	2.89
10674	1/2" x 2-1/2"	3.46
10675	1/2" x 3"	4.03
10676	1/2" x 3-1/2"	4.60

**304/SS Weld Sch 40 - 1/2"  
 (Continued)**

Part #	Size	Price
10677	1/2" x 4"	5.19
10678	1/2" x 4-1/2"	5.76
10679	1/2" x 5"	6.34
10680	1/2" x 5-1/2"	6.90
10681	1/2" x 6"	7.48

**304/SS Weld Sch 40 - 3/4"**

Part #	Size	Price
10682	3/4" x Close	2.70
10683	3/4" x 1-1/2"	2.87
10684	3/4" x 2"	3.44
10685	3/4" x 2-1/2"	4.13
10686	3/4" x 3"	4.82
10687	3/4" x 3-1/2"	5.51
10688	3/4" x 4"	6.20
10689	3/4" x 4-1/2"	6.89
10690	3/4" x 5"	7.58
10691	3/4" x 5-1/2"	8.27
10692	3/4" x 6"	8.97

**304/SS Weld Sch 40 - 1"**

Part #	Size	Price
10693	1" x Close	3.54
10694	1" x 2"	4.44
10695	1" x 2-1/2"	5.27
10696	1" x 3"	6.16
10697	1" x 3-1/2"	7.05
10698	1" x 4"	7.94
10699	1" x 4-1/2"	8.83
10700	1" x 5"	9.72
10701	1" x 5-1/2"	10.61
10702	1" x 6"	11.50

**304/SS Weld Sch 40 - 1-1/4"**

Part #	Size	Price
10703	1-1/4" x Close	4.76
10704	1-1/4" x 2"	5.61
10705	1-1/4" x 2-1/2"	6.64
10706	1-1/4" x 3"	7.77
10707	1-1/4" x 3-1/2"	8.90
10708	1-1/4" x 4"	10.03
10709	1-1/4" x 4-1/2"	11.15
10710	1-1/4" x 5"	12.28
10711	1-1/4" x 5-1/2"	13.41
10712	1-1/4" x 6"	14.54

**304/SS Weld Sch 40 - 1-1/2"**

Part #	Size	Price
10713	1-1/2" x Close	5.83
10714	1-1/2" x 2"	6.39
10715	1-1/2" x 2-1/2"	7.72
10716	1-1/2" x 3"	9.05
10717	1-1/2" x 3-1/2"	10.39
10718	1-1/2" x 4"	11.72
10719	1-1/2" x 4-1/2"	13.05
10720	1-1/2" x 5"	14.38
10721	1-1/2" x 5-1/2"	15.71
10722	1-1/2" x 6"	17.05

**304/SS Weld Sch 40 - 2"**

Part #	Size	Price
10723	2" x Close	9.04
10724	2" x 2-1/2"	10.07
10725	2" x 3"	11.66
10726	2" x 3-1/2"	13.40
10727	2" x 4"	15.13
10728	2" x 4-1/2"	16.87
10729	2" x 5"	18.60
10730	2" x 5-1/2"	20.34
10731	2" x 6"	22.08

**316/SS Nipples - 1/4"**

Part #	Size	Price
10848	1/4" x Close	1.59
10849	1/4" x 1-1/2"	2.04
10850	1/4" x 2"	2.49
10851	1/4" x 2-1/2"	2.97
10852	1/4" x 3"	3.45
10853	1/4" x 3-1/2"	3.93
10854	1/4" x 4"	4.44
10855	1/4" x 4-1/2"	4.92
10856	1/4" x 5"	5.40
10857	1/4" x 5-1/2"	5.88
10858	1/4" x 6"	6.36

**316/SS Nipples - 3/8"**

Part #	Size	Price
10859	3/8" x Close	1.97
10860	3/8" x 1-1/2"	2.46
10861	3/8" x 2"	3.02
10862	3/8" x 2-1/2"	3.62
10863	3/8" x 3"	4.22
10864	3/8" x 3-1/2"	4.82
10865	3/8" x 4"	5.42

Pipe, Fittings, Hardware

Prices & specifications are subject to change.



**Nipples**



**316/SS Nipples - 3/8" (Continued)**

Part #	Size	Price
10866	3/8" x 4-1/2"	6.02
10867	3/8" x 5"	6.62
10868	3/8" x 5-1/2"	7.22
10869	3/8" x 6"	7.83

**316/SS Nipples - 1/2"**

Part #	Size	Price
10870	1/2" x Close	2.62
10871	1/2" x 1-1/2"	3.22
10872	1/2" x 2"	3.94
10873	1/2" x 2-1/2"	4.77
10874	1/2" x 3"	5.59
10875	1/2" x 3-1/2"	6.41
10876	1/2" x 4"	7.26
10877	1/2" x 4-1/2"	8.08
10878	1/2" x 5"	8.81
10879	1/2" x 5-1/2"	9.73
10880	1/2" x 6"	10.55

**316/SS Nipples - 3/4"**

Part #	Size	Price
10881	3/4" x Close	3.41
10882	3/4" x 1-1/2"	3.65
10883	3/4" x 2"	4.46
10884	3/4" x 2-1/2"	5.39
10885	3/4" x 3"	6.32
10886	3/4" x 3-1/2"	7.25
10887	3/4" x 4"	8.18
10888	3/4" x 4-1/2"	9.12
10889	3/4" x 5"	10.05
10890	3/4" x 5-1/2"	10.98
10891	3/4" x 6"	11.92

**316/SS Nipples - 1"**

Part #	Size	Price
10892	1" x Close	4.74
10893	1" x 2"	6.01
10894	1" x 2-1/2"	7.21
10895	1" x 3"	8.48
10896	1" x 3-1/2"	9.75
10897	1" x 4"	11.01
10898	1" x 4-1/2"	12.28
10899	1" x 5"	13.55
10900	1" x 5-1/2"	14.82
10901	1" x 6"	16.09

**316/SS Nipples - 1-1/4"**

Part #	Size	Price
10902	1-1/4" x Close	6.48
10903	1-1/4" x 2"	7.71
10904	1-1/4" x 2-1/2"	9.24
10905	1-1/4" x 3"	10.88
10906	1-1/4" x 3-1/2"	12.51
10907	1-1/4" x 4"	14.15
10908	1-1/4" x 4-1/2"	15.78
10909	1-1/4" x 5"	17.42
10910	1-1/4" x 5-1/2"	19.05
10911	1-1/4" x 6"	20.68

**316/SS Nipples- 1-1/2"**

Part #	Size	Price
10912	1-1/2" x Close	8.01
10914	1-1/2" x 2-1/2"	10.79
10915	1-1/2" x 3"	12.72
10916	1-1/2" x 3-1/2"	14.65
10917	1-1/2" x 4"	16.58
10918	1-1/2" x 4-1/2"	18.51
10919	1-1/2" x 5"	20.44
10920	1-1/2" x 5-1/2"	22.37
10921	1-1/2" x 6"	24.30

**316/SS Nipples - 2"**

Part #	Size	Price
10922	2" x Close	12.43
10923	2" x 2-1/2"	14.22
10924	2" x 3"	16.61
10925	2" x 3-1/2"	19.15
10926	2" x 4"	21.70
10927	2" x 4-1/2"	24.24
10928	2" x 5"	26.79
10929	2" x 5-1/2"	29.34
10930	2" x 6"	31.88

Prices & specifications are subject to change.

Metropolitan Pipe offers FREE DELIVERY in the Greater Boston area.



## Piping Systems

### Grooved Couplings

#### 772 - Grooved Rigid Couplings

- Anti-rotational gripping teeth along the coupling keys
- Maximum pressure: 750 psi



#### EPDM Mechanical Gasket - Painted

Part #	Mfg #	Size	Price
868251	77215ES	1-1/2"	13.83
868746	77220ES	2"	15.36
869005	77225ES	2-1/2"	17.60
869276	77230ES	3"	20.39
869520	77240ES	4"	28.49
869808	77250ES	5"	36.86
870028	77260ES	6"	48.59
870311	77280ES	8"	76.66
868135	77210ES	10"	221.16

#### EPDM Mechanical Gasket - Galvanized

Part #	Mfg #	Size	Price
868745	77220EGS	2"	19.41
869004	77225EGS	2-1/2"	22.34
869275	77230EGS	3"	26.11
869519	77240EGS	4"	36.86
870027	77260EGS	6"	63.11

#### 705 - Grooved Flexible Coupling

- Maximum pressure: 500 psi



#### EPDM Mechanical Gasket - Painted

Part #	Mfg #	Size	Price
868303	70513ES	1-1/4"	10.48
868235	70515ES	1-1/2"	12.71
868721	70520ES	2"	15.50
868981	70525ES	2-1/2"	18.02
869252	70530ES	3"	20.11
869496	70540ES	4"	28.91
869784	70550ES	5"	43.84
870004	70560ES	6"	51.94
870288	70580ES	8"	84.47

#### 716 - Grooved Flexible Reducing Couplings

- Provides a direct transition between 2 different pipe sizes; rather than (2) couplings and a reducing fitting
- Maximum pressure: 500 psi



#### EPDM Gasket - Painted

Part #	Mfg #	Size	Price
868795	7162015ES	2" x 1-1/2"	20.67
869104	7162520ES	2-1/2" x 2"	26.67
869372	7163020ES	3" x 2"	30.44
869401	7163025ES	3" x 2-1/2"	26.25
869618	7164020ES	4" x 2"	48.03
869646	7164025ES	4" x 2-1/2"	43.15
869678	7164030ES	4" x 3"	40.36
869911	7165040ES	5" x 4"	54.18
870171	7166040ES	6" x 4"	81.82
870203	7166050ES	6" x 5"	71.63
870409	7168060ES	8" x 6"	122.31

#### EPDM Gasket - Galvanized

Part #	Mfg #	Size	Price
881346	7162520EGS	2-1/2" x 2"	33.37
881343	7163020EGS	3" x 2"	38.40
881341	7163025EGS	3" x 2-1/2"	33.37
869645	7164025EGS	4" x 2-1/2"	56.69

#### 71 - Flange Adapter

- ANSI Class 125/150
- Provides a direct transition from flanged components to a grooved piping system
- Maximum pressure: 300 psi



#### EPDM Gasket - Painted

Part #	Mfg #	Size	Price
868741	7120S	2"	60.88
869000	7125S	2-1/2"	75.40
869271	7130S	3"	81.54
869515	7140S	4"	108.77
869803	7150S	5"	126.36
870023	7160S	6"	137.81
870307	7180S	8"	155.54
868130	7110S	10"	246.01

#### Flange Seal Washers

- For use with #71
- For use with butterfly valves

Part #	Mfg #	Size	Price
868739	7120FWC	2"	21.37
868998	7125FWC	2-1/2"	22.62



## Piping Systems

### Flange Seal Washers (Continued)

Part #	Mfg #	Size	Price
869269	7130FWC	3"	26.39
869513	7140FWC	4"	30.58
869801	7150FWC	5"	37.28
870021	7160FWC	6"	42.45
870305	7180FWC	8"	53.76
886179	7110FWC	10"	74.42

### Grooved Fittings

#### 201 - Mechanical Grooved 45° Elbow



Painted

Part #	Mfg #	Size	Price
868212	20115S	1-1/2"	16.12
868690	20120S	2"	18.30
868946	20125S	2-1/2"	18.30
869217	20130S	3"	32.40
869460	20140S	4"	35.19
869751	20150S	5"	84.05
869968	20160S	6"	98.71
870255	20180S	8"	205.66

#### Galvanized

Part #	Mfg #	Size	Price
868945	20125GS	2-1/2"	23.04
869216	20130GS	3"	38.12
869459	20140GS	4"	45.66
869967	20160GS	6"	124.54

#### 210 - Mechanical Grooved 90° Elbow



Painted

Part #	Mfg #	Size	Price
868214	21015S	1-1/2"	18.30
868692	21020S	2"	18.30
868948	21025S	2-1/2"	18.30
869219	21030S	3"	32.40
869462	21040S	4"	35.19
869753	21050S	5"	84.05

### 210 - Mechanical Grooved 90° Elbow

#### Painted (Continued)

Part #	Mfg #	Size	Price
869970	21060S	6"	98.71
870257	21080S	8"	205.66

#### Galvanized

Part #	Mfg #	Size	Price
868947	21025GS	2-1/2"	24.30
869218	21030GS	3"	40.36
869461	21040GS	4"	49.29
869969	21060GS	6"	130.83

### 314 - Mechanical Grooved Lateral



Galvanized

Part #	Mfg #	Size	Price
869477	74703	4"	253.44
869984	74704	6"	574.81

### 219 - Mechanical Grooved Tee



Painted

Part #	Mfg #	Size	Price
868694	21920S	2"	28.35
868950	21925S	2-1/2"	28.35
869221	21930S	3"	38.96
869464	21940S	4"	59.34
869755	21950S	5"	138.50
869972	21960S	6"	159.87
870259	21980S	8"	350.44

#### Galvanized

Part #	Mfg #	Size	Price
868949	21925GS	2-1/2"	37.14
869220	21930GS	3"	53.34
869463	21940GS	4"	80.56
869971	21960GS	6"	218.23

Prices & specifications are subject to change.

Metropolitan Pipe offers Vendor Managed Inventory - never run out of that part again!



## Piping Systems

### 221/321 - Cast Grooved Reducing Tee

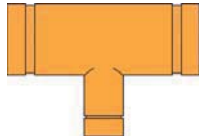

Painted

Part #	Mfg #	Size	Price
869411	2213020S	3" x 3" x 2"	52.92
869416	75419	3" x 3" x 2-1/2"	52.92
867989	2214020S	4" x 4" x 2"	71.49
869723	75423	4" x 4" x 2-1/2"	77.99
869728	2214030S	4" x 4" x 3"	71.49
869921	75425	5" x 5" x 2"	189.02
869926	75426	5" x 5" x 2-1/2"	153.99
867990	75427	5" x 5" x 3"	153.99
869936	75428	5" x 5" x 4"	166.63
872360	2216020S	6" x 6" x 2"	168.10
867991	2216040S	6" x 6" x 4"	168.10
870240	75433	6" x 6" x 5"	183.38

### 250/350 - Cast Grooved Concentric Reducer

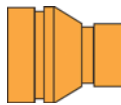

Painted

Part #	Mfg #	Size	Price
868817	72853	2" x 1-1/4"	25.44
868788	72854	2" x 1-1/2"	23.31
869049	2502515S	2-1/2" x 1-1/2"	21.37
869098	2502520S	2-1/2" x 2"	21.37
867896	2503015S	3" x 1-1/2"	25.84
869365	2503020S	3" x 2"	18.85
869395	2503025S	3" x 2-1/2"	25.84
869612	2504020S	4" x 2"	25.14
869639	2504025S	4" x 2-1/2"	31.14
869669	2504030S	4" x 3"	31.14
869884	2505030S	5" x 3"	36.03
869903	2505040S	5" x 4"	43.01
870136	2506030S	6" x 3"	56.97
870163	2506040S	6" x 4"	49.85
870196	2506050S	6" x 5"	73.44
870354	2508030S	8" x 3"	101.51
867897	2508050S	8" x 5"	101.51
870397	2508060S	8" x 6"	129.01

#### Galvanized

Part #	Mfg #	Size	Price
869394	2503025GS	3" x 2-1/2"	31.14
869668	2504030GS	4" x 3"	31.14

### 250/350 - Cast Grooved Concentric Reducer Galvanized (Continued)

Part #	Mfg #	Size	Price
870162	2506040GS	6" x 4"	64.51

### 251 - Cast Grooved Eccentric Reducer



Painted

Part #	Mfg #	Size	Price
869100	72933	2-1/2" x 2"	23.31
869366	2513020S	3" x 2"	50.97
869397	2513025S	3" x 2-1/2"	50.97
867899	2514025S	4" x 2-1/2"	62.27
869671	2514030S	4" x 3"	62.27
869905	2515040S	5" x 4"	84.61
870165	2516040S	6" x 4"	98.57
870197	2516050S	6" x 5"	118.12

### 260 - Grooved Cap



Painted

Part #	Mfg #	Size	Price
868697	26020S	2"	15.50
868954	26025S	2-1/2"	15.50
868952	26025T75S	2-1/2" w/ 3/4" Tap	18.02
869226	26030S	3"	15.50
869224	26030T75S	3" w/ 3/4" Tap	18.02
869469	26040S	4"	16.62
869467	26040T75S	4" w/ 3/4" Tap	18.02
869760	26050S	5"	38.96
869977	26060S	6"	38.82
869975	26060T75S	6" w/ 3/4" Tap	113.51
870264	26080S	8"	74.28

#### Galvanized

Part #	Mfg #	Size	Price
869225	26030GS	3"	18.58
876282	26040GS	4"	21.78
869976	26080GS	8"	52.22





## Piping Systems

### 391 - Adapter Nipple - (Grooved x MNPT)



Painted

Part #	Mfg #	Size	Price
868324	75121	1-1/4" x 4"	12.04
868047	75122	1-1/2" x 4"	12.04
868852	75123	2" x 4"	12.04
869127	75124	2-1/2" x 4"	13.86
869426	75125	3" x 4"	16.91
869737	75126	4" x 6"	27.72

### 407GT - Clearflow Dielectric Waterway - (Grooved x FNPT)

- Painted



Part #	Mfg #	Size	Price
868042	41467	1-1/2" x 4"	51.79
868857	41468	2" x 4"	52.80
869131	41469	2-1/2" x 6"	71.76
867859	41470	3" x 6"	129.30

## Mechanical Tees

### 730 - Mechanical Tees

- Can be used in place of a tee, cross connection, or welded outlet
- Suitable for retrofit or equipment hookup installations
- Maximum pressure: 500 psi



#### Grooved Branch - EPDM Gasket - Painted

Part #	Mfg #	Size	Price
881178	7303015ERS	3" x 1-1/2"	25.00
869380	7303020ERS	3" x 2"	28.77
869626	7304020ERS	4" x 2"	30.44
869654	7304025ERS	4" x 2-1/2"	31.70
869686	7304030ERS	4" x 3"	33.79
870100	7306020ERS	6" x 2"	38.12
870122	7306025ERS	6" x 2-1/2"	41.75
870148	7306030ERS	6" x 3"	43.56
870179	7306040ERS	6" x 4"	48.31
870343	7308025ERS	8" x 2-1/2"	66.60
890672	7308030ERS	8" x 3"	70.37

#### FNPT Branch - EPDM Gasket - Painted

Part #	Mfg #	Size	Price
868848	73020075ES	2" x 3/4"	17.04

### 730 - Mechanical Tees

#### FNPT Branch - EPDM Gasket - Painted (Continued)

Part #	Mfg #	Size	Price
868782	7302010ES	2" x 1"	17.04
868836	7302013ES	2" x 1-1/4"	19.69
868813	7302015ES	2" x 1-1/2"	19.69
869045	7302505ES	2-1/2" x 1/2"	17.04
869034	73025075ES	2-1/2" x 3/4"	17.04
869041	7302510ES	2-1/2" x 1"	17.04
869095	7302513ES	2-1/2" x 1-1/4"	24.16
869070	7302515ES	2-1/2" x 1-1/2"	24.16
869315	7303005ES	3" x 1/2"	19.69
869422	73030075ES	3" x 3/4"	19.69
869311	7303010ES	3" x 1"	19.69
869361	7303013ES	3" x 1-1/4"	25.00
869338	7303015ES	3" x 1-1/2"	25.00
869390	7303020ES	3" x 2"	28.77
869561	7304005ES	4" x 1/2"	24.86
869704	73040075ES	4" x 3/4"	24.86
869557	7304010ES	4" x 1"	24.86
869608	7304013ES	4" x 1-1/4"	29.19
869585	7304015ES	4" x 1-1/2"	30.44
869634	7304020ES	4" x 2"	30.44
869664	7304025ES	4" x 2-1/2"	31.70
869696	7304030ES	4" x 3"	33.79
869847	7305015ES	5" x 1-1/2"	37.14
869868	7305020ES	5" x 2"	37.14
869880	7305025ES	5" x 2-1/2"	39.24
869896	7305030ES	5" x 3"	41.75
870085	7306013ES	6" x 1-1/4"	32.34
870060	7306015ES	6" x 1-1/2"	38.12
870108	7306020ES	6" x 2"	38.12
870132	7306025ES	6" x 2-1/2"	41.05
870158	7306030ES	6" x 3"	43.56
870189	7306040ES	6" x 4"	48.31
870351	7308025ES	8" x 2-1/2"	66.60
870370	7308030ES	8" x 3"	70.37
870389	738040ES	8" x 4"	72.47

Prices & specifications are subject to change.

Our faucet parts counter is one of the largest in the Boston area with thousands of parts in stock!



## Piping Systems

### Grooved Valves

#### 590 - Grooved Swing Check Valves

- Ductile iron body and cap
- Nickel seat
- Maximum working pressure: 300 psi



EPDM

Part #	Mfg #	Size	Price
868974	59030025	2-1/2"	500.50
869246	59030030	3"	322.55
869489	59030040	4"	625.00
869777	59030050	5"	566.57
869997	59030060	6"	671.54

#### B302 - Butterfly Valve Grooved, EPDM or Nitrile

- The GRINNELL Model B302 Butterfly Valve provides for efficient control of on/off or throttling/balancing service, fluid flow, and "bubble tight" shut-off in piping systems.
- Flow can be from either direction and the valve may be positioned in any orientation.
- The valve is furnished with grooved ends for use with grooved couplings and can be easily adapted to flanged components using GRINNELL Figure 71 Class 150 Flange Adapters.



Part #	Mfg #	Size	Price
868754	B3022E	2"	172.83
869013	B30225	2-1/2"	212.86
869284	B30230	3"	222.03
869528	B30240	4"	265.27
869816	B30250	5"	472.67
870036	B30260	6"	499.19
870318	B30280EG	8"	786.01

#### CB800 - Circuit Balancing Valve (Groove x Groove)

- For throttling, draining, filling, positive shutoff and measuring differential pressure
- EPDM E O-ring
- 235 psi @ 300°F

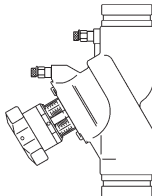

Part #	Mfg #	Size	Price
869017	CB8002504	2-1/2"	402.71
869288	CB8003004	3"	627.31
869532	CB8004004	4"	867.55
869820	CB8005004	5"	1421.14
870040	CB8006004	6"	2103.68

### Grooved Accessories

#### S853 - Grooved Y-Strainer

- Ductile iron body, cover & coupling disc
- Type 304 stainless steel ASTM-240 screen
- Non-Asbestos gasket
- Pressure rated for 640 psi @ 100°F



Painted

Part #	Mfg #	Size	Price
869290	S85330	3"	768.33
869534	S85340	4"	869.21
885428	S85360	6"	1236.54

#### S855 - Grooved Tee Strainer

- Ductile iron body, cover & coupling disc
- Cover secured by 772 coupling
- Cover is tapped and plugged
- Type 304 stainless steel ASTM-240 screen



Painted

Part #	Mfg #	Pressure Rated		Price
		Size	@ 100°F	
869021	S85525	2-1/2"	750 psi	675.63
869292	S85530	3"	750 psi	758.24
869536	S85540	4"	750 psi	858.31
869824	S85550	5"	750 psi	1243.29
870044	S85560	6"	700 psi	1349.08

### Copper Grooved System

#### 672 - Copper Rigid Couplings with Grade EN Tri-Seal Gasket

- UL, ULC, and UPC; NSF 61
- Recommended for low temperature and vacuum applications
- Maximum pressure: 300 psi



Part #	Mfg #	Size	Price
868764	67220EN3	2"	17.47
869023	67225EN3	2-1/2"	19.91
869294	67230EN3	3"	22.14
869538	67240EN3	4"	33.31
869826	67250EN3	5"	56.46
870046	67260EN3	6"	74.53



## Piping Systems



### 61 - Copper Flange Adapter with Grade EN EPDM

- UL, ULC, and UPC; NSF 61
- Provides a direct transition from flanged components to a grooved copper tube system
- Maximum pressure: 300 psi



Part #	Mfg #	Size	Price
868763	61	2"	219.78
869022	61	2-1/2"	228.69
869293	61	3"	239.58
869537	61	4"	263.01
869825	61	5"	353.76
870045	61	6"	384.78

### Phenolic Washers

- For #61 copper flange adapter
- For use with butterfly valves

Part #	Mfg #	Size	Price
868767	61PW20	2"	29.37
869026	61PW25	2-1/2"	32.01
869297	61PW30	3"	34.32
869540	61PW40	4"	54.45
870048	61PW60	6"	67.32

### 601 - Grooved Copper 45° Elbow



Part #	Mfg #	Size	Price
868716	64520S	2"	50.16
868976	64525S	2-1/2"	54.45
869247	64530S	3"	76.89
869491	64540S	4"	177.21
869779	64550S	5"	503.25
869999	64560S	6"	803.22

### 610 - Grooved Copper 90° Elbow



Part #	Mfg #	Size	Price
868717	61020S	2"	50.16
868977	61025S	2-1/2"	54.45
869248	61030S	3"	76.89
869492	61040S	4"	177.21
869780	61050S	5"	503.25
870000	61060S	6"	803.22

### 618 - Copper Reducing Tee - (Grooved x Grooved x Wrot)

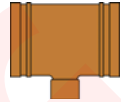

Part #	Mfg #	Size	Price
868682	6182015WA	2" x 2" x 1-1/2"	106.59
868944	61825075WA	2-1/2" x 2-1/2" x 3/4"	135.63
868930	6182510WA	2-1/2" x 2-1/2" x 1"	132.33
868934	6182513WA	2-1/2" x 2-1/2" x 1-1/4"	132.33
868932	6182515WA	2-1/2" x 2-1/2" x 1-1/2"	132.33
869200	6183010WA	3" x 3" x 1"	244.86
869203	6183013WA	3" x 3" x 1-1/4"	244.86
869201	6183015WA	3" x 3" x 1-1/2"	244.86
869456	61840075WA	4" x 4" x 3/4"	289.74
869440	6184010WA	4" x 4" x 1"	380.16
869442	6184013WA	4" x 4" x 1-1/4"	380.16
869441	6184015WA	4" x 4" x 1-1/2"	380.16

### 619 - Grooved Copper Tee

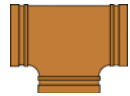

Part #	Mfg #	Size	Price
868718	61920S	2"	83.16
868978	61925S	2-1/2"	88.44
869249	61930S	3"	131.67
869493	61940S	4"	289.08
869781	61950S	5"	810.48
870001	61960S	6"	1001.55

### 621 - Grooved Copper Reducing Tee

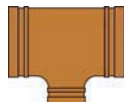

Part #	Mfg #	Size	Price
868937	6212520	2-1/2" x 2"	132.00
869206	6213020	3" x 2"	169.62
869211	6213025	3" x 2-1/2"	224.07
869445	6214020	4" x 2"	380.16
869450	6214025	4" x 2-1/2"	380.16
869454	6214030	4" x 3"	380.16
869744	6215030	5" x 3"	1161.60
869748	6215040	5" x 4"	1161.60
869953	6216025	6" x 2-1/2"	1418.67
869956	6216030	6" x 3"	1418.67
869960	6216040	6" x 4"	1418.67
869963	6216050	6" x 5"	1418.67

### 650 - Grooved Copper Concentric Reducer



Part #	Mfg #	Size	Price
868938	6502520	2-1/2" x 2"	72.60
869207	6503020	3" x 2"	72.60

Prices & specifications are subject to change.

Our office hours are 7am to 4:30pm and counter hours 6am to 4:30pm Monday through Friday.



## Piping Systems

### 650 - Grooved Copper Concentric Reducer (Continued)

Part #	Mfg #	Size	Price
869212	6503025	3" x 2-1/2"	72.60
869446	6504020	4" x 2"	149.16
869451	6504025	4" x 2-1/2"	149.16
869455	6504030	4" x 3"	149.16
869749	6505040	5" x 4"	420.75
869957	6506030	6" x 3"	455.40
869961	6506040	6" x 4"	455.40
869964	6506050	6" x 5"	455.40

### 652 - Copper Concentric Reducer - (Grooved x Wrot)



Part #	Mfg #	Size	Price
868683	6522015W	2" x 1-1/2"	60.06
868931	6522510W	2-1/2" x 1"	73.59
868929	6522513W	2-1/2" x 1-1/4"	73.59
868933	6522515W	2-1/2" x 1-1/2"	73.59
868939	6522520W	2-1/2" x 2"	73.59
869202	6523015W	3" x 1-1/2"	91.41
869208	6523020W	3" x 2"	91.41
869447	6524020W	4" x 2"	170.28

### 660 - Copper Cap



Part #	Mfg #	Size	Price
868719	66020S	2"	34.65
868979	66025S	2-1/2"	51.48
869250	66030S	3"	64.35
869494	66040S	4"	96.69
869782	66050S	5"	108.90
870002	66060S	6"	198.00

### B680 - Grooved Copper Butterfly Valves

- 10-Position locking lever handle
- EPDM Encapsulated ductile iron disc
- Maximum pressure: 300 psi



Part #	Mfg #	Size	Price
871153	68020EL	2"	401.43
871152	68025EL	2-1/2"	557.11
871150	68030EL	3"	611.94
871149	68040EL	4"	774.07
871148	68050EL	5"	984.59
870050	68060EL	6"	1052.28

## Gaskets

### Flange Adapter Replacement Gasket

- For #71 flange adapter

#### EPDM

Part #	Mfg #	Size	Price
868739	7120EPDME	2"	21.37
868998	7125EPDME	2-1/2"	22.62
869269	7130EPDME	3"	26.39
869513	7140EPDME	4"	30.58
869801	7150EPDME	5"	37.28
870021	7160EPDME	6"	42.45
870305	7180EPDME	8"	53.76
868383	7112EPDME	12"	108.77

### Replacement Gaskets - Grade "E" EPDM

- For 705 & 707 flexible couplings and 772 rigid coupling

Part #	Mfg #	Size	Price
869027	GE25	2-1/2"	9.64
869298	GE30	3"	10.48
869541	GE40	4"	13.13
870049	GE60	6"	18.30
870329	GE80	8"	25.00

### Replacement Gaskets - Grade "EN" EPDM

- For 61 CTS flange adapter

Part #	Mfg #	Size	Price
868769	GEN20	2"	18.48
869028	GEN25	2-1/2"	20.79
869299	GEN30	3"	22.44
869542	GEN40	4"	28.38
869829	GEN50	5"	34.65

### Replacement Gaskets - Tri-Seal Grade "EN" EPDM

- For 672 CTS rigid coupling

Part #	Mfg #	Size	Price
868770	GTRIEN20	2"	14.22
869029	GTRIEN25	2-1/2"	15.44
869300	GTRIEN30	3"	16.45
869543	GTRIEN40	4"	23.97
869830	GTRIEN50	5"	40.01



## Specialty Fittings



### Mission - Band-Seal® Specialty Shielded Transition Couplings

- Shielded Transition Couplings join similar and dissimilar pipe sizes and pipe materials.
- Resists shear forces while maintaining alignment
- Corrosion-resistant 300 Series stainless steel components
- Creates a rigid, durable, long lasting joint
- Internal rubber sleeve reduces noise and vibration
- Easy to assemble, disassemble and reuse
- Neoprene rubber sleeve conforms to ASTM C 564
- Band-Seal® Specialty Couplings conform to ASTM C 1460
- Material Guide
  - **CI** Cast Iron
  - **K** Copper
  - **P** Plastic Schedule 40
  - **ST** Steel
  - **XHCI** Extra Heavy Cast Iron
  - **T** Tubular



#### How to use:

- Find the size(s) you want to transition
- Use the material guide to the left to find the correct coupling

Part#	Mfg#	Size A	Size B	Material(s) A	Material(s) B	Price
9944	CK 115	1-1/2"	1-1/2"	CI, PL, ST	K	9.49
9951	CP 150	1-1/2"	1-1/2"	CI, PL, ST	PL, ST	6.78
9958	K 150	1-1/2"	1-1/2"	K	K	10.24
9966	T 215	1-1/2"	2"	T	CI, PL, ST	11.09
9953	CP 215	2"	1"	CI, PL, ST	PL, ST	9.03
9946	CK 215	2"	1-1/2"	CI, PL, ST	K	9.49
241642	KC 215	2"	1-1/2"	K	CI, PL, ST	18.58
9947	CK 22	2"	2"	CI, PL, ST	K	12.47
9952	CP 200	2"	2"	CI, PL, ST	PL, ST	6.78
9959	K 200	2"	2"	K	K	10.96
9967	C 320	3"	2"	CI	CI, PL, ST	10.69
9948	CK 32	3"	2"	CI	K	14.11
9949	CK 33	3"	3"	CI	K	13.38
9954	CP 33	3"	3"	CI	PL, ST, XHCI	10.34
9960	K 300	3"	3"	K	K	12.50
9962	P 300	3"	3"	PL, ST, XHCI	PL, ST, XHCI	10.87
9964	PK 33	3"	3"	PL, ST, XHCI	K	11.96
9968	C 420	4"	2"	CI	CI, PL, ST	13.02
9969	C 430	4"	3"	CI	CI	12.69
9950	CK 43	4"	3"	CI	K	14.33
9955	CP 43	4"	3"	CI	PL, ST, XHCI	15.11
112632	CK 44	4"	4"	CI	K	14.11
9956	CP 44	4"	4"	CI	PL, ST, XHCI	11.30
9963	P 400	4"	4"	PL, ST, XHCI	PL, ST, XHCI	12.71
55641	CP 55	5"	5"	CI	PL, ST, XHCI	24.31
9957	CP 66	6"	6"	CI	PL, ST, XHCI	32.52
112638	CP 88	8"	8"	CI	PL, ST, XHCI	44.27

Prices & specifications are subject to change.

You can check stock availability, pricing and place orders online at [www.MetPipe.com](http://www.MetPipe.com).



## Specialty Fittings

### Mission Flex-Seal® Repair Couplings

- Sleeve is manufactured of molded natural and synthetic rubber
- Inside surfaces of transitional size couplings are stepped to conform better to different pipe sizes
- Two 300 Series Stainless Steel worm drive clamping bands hold pipe ends securely
- Use of stainless steel clamping bands are highly effective in a variety of environments
- Blends of natural and synthetic rubbers permit a substantial degree of distortion without change in basic physical or chemical resistance



#### Cast Iron or Plastic transitioning to Cast Iron or Plastic

Part#	Mfg#	Size	Material(s)	Price
9933	MR56-15	1-1/2"	Cast Iron or Plastic	3.96
9935	MR56-215	2" x 1-1/2"	Cast Iron or Plastic	4.50
9934	MR56-22	2"	Cast Iron or Plastic	4.26
9936	MR56-33	3"	Cast Iron or Plastic	5.76
45749	MR56-42	4" x 2"	Cast Iron or Plastic	10.04
9939	MR56-43	4" x 3"	Cast Iron or Plastic	7.76
9938	MR56-44	4"	Cast Iron or Plastic	7.21
42348	MR56-54	5" x 4"	Cast Iron or Plastic	13.55
9941	MR56-64	6" x 4"	Cast Iron or Plastic	18.09
9940	MR56-66	6"	Cast Iron or Plastic	15.41
119212	MR56-86	8" x 6"	Cast Iron or Plastic	28.61
9942	MR56-88	8"	Cast Iron or Plastic	56.12

#### Clay transitioning to Cast Iron or Plastic

Part#	Mfg#	From Size	To Size	Material(s)	Price
9943	MR02-64	6"	4"	Cast Iron or Plastic	18.09
41850	MR02-66	6"	6"	Cast Iron or Plastic	15.41

Pipe, Fittings, Hardware



### Steel Couplings

#### Style 38 For Steel and Cast Iron Pipe

- Provides flexible, leak proof connections
- Consists of: (1) cylindrical steel middle ring; (2) resilient gaskets of special Dresser compound; set of 5/8" x 8-1/4" steel track head bolts



#### For Water

Part #	Mfg #	IPS	OD	Nbr of Bolts	--- Overall --- Diameter x Height	Working Pressure	Max Test Pressure	Price
48271	0038-0022-011	2-1/2"	2.875"	3	7" x 7"	1500 psi	2250 psi	128.74
145787	0038-9187-011	3"	3.500"	4	7-3/8" x 7"	1100 psi	1650 psi	123.89
145788	0038-9036-011	4"	4.500"	4	8-3/4" x 7"	1000 psi	1500 psi	161.70

Prices & specifications are subject to change.



## Fittings



### Extended Couplings for Steam

Part #	Mfg #	IPS	OD	Nbr of Bolts	--- Overall --- Diameter x Height	Working Pressure	Max Test Pressure	Price
145786	0038-0022-345	2-1/2"	2.875"	3	7" x 9"	1500 psi	2250 psi	227.68
145789	0038-9187-345	3"	3.500"	4	7-5/8" x 9"	1100 psi	1650 psi	205.58
145790	0038-9036-345	4"	4.500"	4	8-1/4" x 9"	1000 psi	1500 psi	220.32



### Band-Seal® End Caps



- Flexible rubber end caps for capping cast iron, steel, PVC, and ABS pipe ends.
- Molded "X" braces end cap against head pressures encountered in testing. Axially tapered design distributes and dissipates internal stresses
- Fast and easy to use over and over, and withstands rough field handling. 300 Series stainless steel clamp may be tightened or loosened in seconds with a screwdriver or wrench.
- Needs No Plastic Liner - So strong it doesn't need the usual reinforcing plastic disk or liner. So easy to put on and take off that it makes an ideal permanent clean-out. Perfect protection against entry of dirt into pipe plus resists water and ozone.
- Creates wedge against pipe inside, balancing outward strains against the restricting exterior steel band.



**Pipe Fabrication Shop**  
 Cutting, threading, grooving, make-on  
 and welding - on site!

Part#	Mfg#	Size	Price
9916	QC-101	1-1/2"	1.86
9917	QC-102	2"	2.18
9918	QC-103	3"	2.75
9919	QC-104	4"	3.52
9920	QC-105	5"	4.71
9921	QC-106	6"	4.84
156895	QC-108	8"	9.76

Pipe, Fittings, Hardware



## Pipe Clamps

### "EM" Emergency Pipe Clamps

- Repairs pit holes, splits & corrosion leaks
- Applied in seconds - outlasts pipe
- Buna-N gaskets



Part #	Mfg #	Size	Price
18448	089906	1/2"	26.40
18449	089905	3/4"	29.40
18450	089904	1"	29.70
18451	089903	1-1/4"	31.70
18452	089902	1-1/2"	33.30
18453	089899	2"	38.20
18454	089896	2-1/2"	43.90
18455	089891	3"	49.75
18457	089888	4"	113.10
18458	089886	5"	158.65
18459	089885	6"	165.60

### Copper Tube Compensators - HP/CPR-FSXFS (Female Sweat x Female Sweat)

- Stainless steel shroud
- Copper tube liner to isolate the bellows from flow impingement
- Tube expansion: 2"
- Working pressure: 200 psi
- Maximum operating temperature: 400°F



Part #	Size	Price
887485	3/4"	Call
212299	1"	Call
212300	1-1/4"	Call
855538	1-1/2"	1.94
786176	2"	238.08



### Flexcomp™ Expansion Compensators

- Absorbs thermal growth in HVAC small diameter piping systems
- Eliminates need and expense of pipe loops or maintenance with packed slip joints

#### Carbon Steel Compensators - HP/STL-MXM (MNPT x MNPT)

- Carbon steel shroud
- Carbon steel liner to isolate the bellows from flow impingement
- Total movement: 2"
- Working pressure: 200 psi
- Maximum operating temperature: 750°F
- Incorporates an internal anti-torque device



Part #	Size	Price
209402	3/4"	106.67
855539	1"	121.05
855540	1-1/4"	155.27
221445	1-1/2"	177.69
221446	2"	212.19

### Hydro-Flex Expansion Compensators



Part #	Description	Price
143476	3/4"c with 8" Flex Connector	27.33
143477	3/4"c with 10" Flex Connector	27.33

### Flexible Connectors



#### Stainless Steel (MIP x MIP)

Part #	Size	Price
951233	1/2" x 6-1/2"	33.21
951234	3/4" x 7"	35.05
110985	1" x 8"	47.17
862665	1-1/4" x 8-1/2"	49.48
134709	1-1/2" x 9"	57.11
180662	2" x 10-1/2"	72.86

#### Bronze Sweat (C x C)

Part #	Size	Price
951163	1/2" x 6-1/2"	47.28
951236	3/4" x 7"	78.38
951237	1" x 8"	78.59
951238	1-1/4" x 8-1/2"	112.69
951239	1-1/2" x 9"	131.91
951240	2" x 10-1/2"	200.66





## Specialty Fittings



### Gruvlok 7005 Roughneck Couplings

- Effective and reliable way of joining plain-end or beveled end pipe.
- Unique gripper action provides a positive pipe joint and allows for working pressure ratings up to 750 PSI (52 bar).



Part #	Mfg #	Size	Price
33685	7005	2"	75.98
33686	7005	2-1/2"	75.98
33687	7005	3"	111.47
33688	7005	4"	129.07
33689	7005	5"	183.92
33690	7005	6"	224.11
33691	7005	8"	395.71



### Straight Couplings

#### 4758 Series Straight Coupling CTS 3 Part Unions (CTS x CTS)

- Copper tube size X copper tube size compression connector for SDR-9 CTS polyethylene tubing.
- Brass fitting includes buna-n gasket, anti-friction ring, Mac-Pak nut with split clamp, and stainless steel screw.



Part #	Mfg #	Size	Price
115751	4758-22	3/4"	19.44
115750	4758-22	1"	22.24
139145	4758-22	1-1/4"	35.10
139147	4758-22	1-1/2"	68.02
139150	4758-22	2"	91.85
115749	4758-22	3/4" x 1"	22.58

#### 4753 Series Straight Coupling (MNPT X Compression)

- Copper Tube Size X Male Pipe Thread compression connector for SDR-9 CTS polyethylene tubing
- Brass fitting includes buna-n gasket, anti-friction ring, Mac-Pak nut with split clamp, and stainless steel screw.



Part #	Mfg #	Size	Price
56829	4753-22	3/4"	15.96
139142	4753-22	1"	18.91
56830	4753-22	1-1/4"	33.05
56831	4753-22	1-1/2"	47.35
56832	4753-22	2"	68.99



### Pipe Connections & Repair Galvanized Malleable Iron Compression Couplings



Part #	Mfg #	Diameter	Length	Price
11174	2560002	1/2"	2-3/4"	7.68
11175	2560004	3/4"	3"	8.95
11176	2560006	1"	3-1/4"	11.58
11177	2560008	1-1/4"	3-1/4"	14.74
11178	2560010	1-1/2"	3-1/4"	18.11
11179	2560012	2"	3-1/2"	26.63

### Hinged Steel Pipe Repair Clamps



Part #	Mfg #	Size	Price
18441	2206002	1/2"	5.16
18442	2206006	3/4"	5.68
18443	2206010	1"	6.00
18444	2206014	1-1/4"	7.58
18445	2206018	1-1/2"	8.11
18446	2206022	2"	8.95

Prices & specifications are subject to change.

Our state of the art pipe shop offers cutting, threading, grooving and make-ons up to 36in!



## Pipe Penetration Sealing

### Pipe Penetration Sealing

#### Link-Seal® Modular Seals

- Link-Seal® modular seals are considered to be the premier method for permanently sealing pipes of any size passing through walls, floors and ceilings.
- Link-Seal modular seals install in up to 75% less time compared to lead-oakum joints, hand fitted flashings, mastics or casing boots.
- Link-Seal modular seals are rated at 20 psig (40 feet of head), which exceeds the performance requirements of most applications.
- Link-Seal modular seals are designed for use as a permanent seal.
- Suitable for use in water, direct ground burial and atmospheric conditions. Provides electrical insulation where cathodic protection is required.
- Seal Element: EPDM (Black), EPDM (Blue)
- Pressure plates: composite
- Bolts & Nuts: Steel with 2-part Zinc Dichromate & Proprietary Corrosion Inhibiting Coating
- Temp. Range: -40 to +250F. (-40 to +121C.)\*  
 \* = Sustained operation near temperature limits may affect life expectancy.

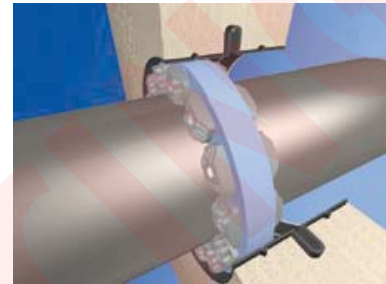

Part #	Mfg #	Sealing Element Thickness	Pressure Plate Length	Pressure Plate Width	Thread Size	10-Link Weight (Lbs)	Min. Required Seating Width	Price
122910	LS-200-C	0.48"	1.06"	0.31"	M5	0.75	2.25"	2.82
159683	LS-275-C	0.61"	0.90"	0.31"	M5	0.85	2.25"	3.70
122752	LS-300-C	0.69"	1.50"	0.44"	5/16-18	2.10	3.00"	4.04
139285	LS-315-C	0.81"	1.44"	0.44"	5/16-18	3.00	3.00"	7.10
187083	LS-325-C	0.88"	3.13"	1.00"	5/16-18	5.50	4.00"	7.92
188093	LS-340-C	1.00"	1.52"	0.67"	5/16-18	3.40	4.00"	10.64
867528	LS-360-C	1.24"	2.05"	0.77"	5/16-18	5.00	4.00"	13.26
141579	LS-400-C	1.38"	3.50"	1.06"	3/8-16	12.00	5.00"	12.78
155401	LS-425-C	1.06"	3.50"	1.19"	3/8-16	10.00	5.00"	12.78
241661	LS-475-C	1.56"	2.63"	0.88"	3/8-16	10.00	5.00"	12.78
933508	LS-500-C	2.25"	3.63"	1.06"	1/2-13	22.50	5.00"	22.30
933509	LS-525-C	2.06"	3.63"	1.00"	1/2-13	21.00	5.00"	22.30
188072	LS-575-C	1.81"	3.00"	1.90"	1/2-13	15.50	5.00"	22.30
933510	LS-600-C	3.09"	6.00"	1.19"	M20x2.5	60.60	6.00"	94.44

**See next page for the LinkSeal sizing chart.**



## Pipe Penetration Sealing

LinkSeal Sizing Chart				
Steel & Plastic Pipe with Same Outside Diameter (IPS)				
PIPE SIZE (NOM.)	ACTUAL O.D.	HOLE I.D.	LINK-SEAL SIZE	LINKS PER SEAL
1/2"	0.840"	2.000"	LS-200	4
3/4"	1.050"	3.000"	LS-315	4
1"	1.315"	3.000"	LS-300	4
1-1/4"	1.660"	3.000"	LS-275	8
1-1/2"	1.900"	4.000"	LS-315	6
2"	2.375"	4.000"	LS-300	6
2-1/2"	2.875"	4.000"	LS-200	9
3"	3.500"	5.000"	LS-300	10
3-1/2"	4.000"	6.000"	LS-315	10
4"	4.500"	6.000"	LS-300	10
5"	5.563"	8.000"	LS-340	13
6"	6.625"	10.000"	LS-475	10
8"	8.625"	12.000"	LS-475	12
10"	10.750"	14.000"	LS-475	14
12"	12.750"	16.000"	LS-475	17
Copper Tubing				
PIPE SIZE (NOM.)	ACTUAL O.D.	HOLE I.D.	LINK-SEAL SIZE	LINKS PER SEAL
1/2"	0.625"	2.000"	LS-275	4
3/4"	0.875"	2.000"	LS-200	4
1"	1.125"	3.000"	LS-315	4
1-1/4"	1.375"	3.000"	LS-300	4
1-1/2"	1.625"	3.000"	LS-275	8
2"	2.125"	4.000"	LS-315	6
2-1/2"	2.625"	4.000"	LS-275	11
3"	3.125"	5.000"	LS-315	8
4"	4.125"	6.000"	LS-315	10
6"	6.125"	8.000"	LS-315	15
8"	8.125"	12.000"	LS-575	10
10"	10.125"	14.000"	LS-575	12
12"	12.125"	16.000"	LS-575	14
Cast Iron Soil Pipe				
PIPE SIZE (NOM.)	ACTUAL O.D.	HOLE I.D.	LINK-SEAL SIZE	LINKS PER SEAL
2"	2.300"	4.000"	LS-315	6
3"	3.300"	5.000"	LS-300	8
4"	4.300"	6.000"	LS-300	10
5"	5.300"	8.000"	LS-360	9
6"	6.300"	8.000"	LS-315	15
8"	8.380"	10.000"	LS-315	19
10"	10.500"	14.000"	LS-475	14
12"	12.500"	16.000"	LS-475	17



## Press Fittings

### ProRadiant SYSTEMS

#### Viega ProRadiant & PureFlow Tubing

##### ViegaPEX Barrier Coils

- Cross-linked polyethylene ViegaPEX Barrier tubing is manufactured to ASTM F876 and F877 standards.
- Recommended for use in floor heating/cooling, snow melting, baseboard and radiator connections.
- Outside PE layer protects oxygen barrier.
- Black with one red stripe for easy identification.
- Listed to NSF/ANSI Standards 14 and 61.
- For use with Viega's press and compression fittings only.



Part#	Mfg#	Size	Price
907035	11400	5/16" x 250'	150.57
907036	11405	5/16" x 1000'	598.98
907038	11415	3/8" x 300'	183.49
907040	11425	1/2" x 300'	196.65
907041	11427	1/2" x 500'	305.31
907043	11435	1/2" x 1200'	769.53
907044	11436	1/2" x 1000'	641.28
907046	11445	5/8" x 500'	368.61
907047	11450	5/8" x 1500'	1104.16
907049	11457	3/4" x 300'	287.98
907052	11462	3/4" x 1000'	940.53
907054	11470	1" x 500'	805.50
907055	11475	1-1/4" x 100'	298.75

##### ViegaPEX Barrier Straight Lengths (20')

- This tubing is the same tubing as used in coils but sold in 20 foot straight lengths for ease of installation on straight runs.



Part#	Mfg#	Size	Price
907057	11490	5/8" x 20'	14.91
907058	11500	3/4" x 20'	19.20
907059	11505	1" x 20'	32.44
907060	11510	1-1/4" x 20'	65.51
907061	11515	1-1/2" x 20'	76.70

#### Viega FostaPEX Coils

- FostaPEX tubing adds aluminum and PE outer layers to the tubing to provide Form Stability and an oxygen barrier.
- FostaPEX can be bent and will hold its new shape — excellent for exposed runs in basements and baseboard connections.
- Can be used anywhere that ViegaPEX Barrier is applicable.
- FostaPEX has an expansion coefficient similar to copper.
- For use with Viega's PEX Press fittings only.



Part#	Mfg#	Size	Price
907624	35019	1/2" x 300'	277.50
907625	35020	1/2" x 150'	138.75
907626	35021	1/2" x 400'	339.38
907627	35030	5/8" x 150'	155.21
907628	35031	5/8" x 400'	451.32
907629	35040	3/4" x 150'	198.54
907630	35060	1" x 150'	346.84

#### Viega FostaPEX Straight Lengths (20')

- This tubing is the same tubing as used in coils but sold in 20 foot straight lengths for ease of installation on straight runs.



Part#	Mfg#	Size	Price
907634	35520	1/2" x 20'	18.64
907635	35530	5/8" x 20'	22.57
907636	35540	3/4" x 20'	26.51

#### Viega PureFlow Coils

- ViegaPEX tubing is manufactured to ASTM F876/F877 standards and listed to ANSI/NSF Standards 14 and 61.
- It is chlorine resistance rated for both traditional (CL-TD) and continuous recirculation (CL-R) applications.
- ViegaPEX tubing is rated at 100 psi at 180 degrees F and 160 psi at 73 degrees F.

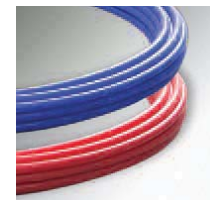

Part#	Mfg#	Size	Color	Price
907503	32101	3/8" x 100'	Red	33.07
907505	32120	1/2" x 1000'	Red	371.27
907506	32121	1/2" x 100'	Red	39.91
907507	32123	1/2" x 300'	Red	119.71
907508	32125	1/2" x 500'	Red	185.64
907509	32140	3/4" x 1000'	Red	673.44
907510	32141	3/4" x 100'	Red	72.39



## Press Fittings



### Viega ProRadiant & PureFlow Tubing (Continued)

#### Viega PureFlow Coils

Part#	Mfg#	Size	Color	Price
907511	32143	3/4" x 300'	Red	217.12
907512	32145	3/4" x 500'	Red	336.73
907514	32201	3/8" x 100'	Blue	35.54
907515	32205	3/8" x 500'	Blue	165.29
907516	32220	1/2" x 1000'	Blue	371.27
907517	32221	1/2" x 100'	Blue	39.91
907518	32223	1/2" x 300'	Blue	119.71
907519	32225	1/2" x 500'	Blue	185.64
907520	32240	3/4" x 100'	Blue	673.44
907521	32241	3/4" x 100'	Blue	72.39
907522	32243	3/4" x 300'	Blue	217.12
907523	32245	3/4" x 500'	Blue	361.86

#### Viega PureFlow Straight Lengths (20')

- This tubing is the same tubing as used in coils but sold in 20 foot straight lengths for ease of installation on straight runs



Part#	Mfg#	Size	Color	Price
907588	33240	1/2" x 20'	Blue	7.98
907589	33265	3/4" x 20'	Blue	14.48
907585	33120	1/2" x 20'	Red	7.98
907586	33145	3/4" x 20'	Red	14.48



### Fittings

#### Copper PEX Press Stub Out Elbows (Stub x C)

- Copper PEX Press stub-outs transition ViegaPEX or FostaPEX tubing to copper for termination at the wall.



Part#	Mfg#	Size	Price
908035	62420	1/2"	5.58
908034	62405	3/8" x 1/2"	6.55

### Bronze PEX Press ProPress Adapters (PEX Press x C)

- Transition directly from ViegaPEX or FostaPEX to copper tubing
- Lead-free coming soon. Not available as of catalog printing.



Part#	Mfg#	Lead-Free #	Size	Price
918620	69620	99620	1/2"	3.41
918625	69640	99640	3/4"	6.09
918626	69660	99660	1"	10.22
918627	69670	99670	1-1/4"	15.89
918628	69680	99680	1-1/2"	21.09
918621	69626	99626	1/2" x 3/4"	5.78
918622	69627	N/A	5/8" x 1/2"	4.70
918623	69628	N/A	5/8" x 3/4"	6.09
918624	69630	99630	3/4" x 1/2"	6.53

### Bronze PEX Press Copper Tubing Adapters (PEX Press x Copper Female)

- Use copper tubing adapters to make a PEX Press connection between ViegaPEX or FostaPEX tubing and standard copper tubing. Adapters solder over copper tubing.
- Lead-free coming soon. Not available as of catalog printing.



Part#	Mfg#	Lead-Free #	Size	Price
918649	82021	92021	1/2"	1.72
918654	82041	92041	3/4"	3.36
918656	82060	92060	1"	5.71
918657	82070	92070	1-1/4"	12.30
918658	82080	92080	1-1/2"	19.31
918648	82006	92006	3/8" x 1/2"	2.38
918650	82026	92026	1/2" x 3/4"	3.25
918651	82027	N/A	5/8" x 1/2"	3.25
918652	82031	N/A	5/8" x 3/4"	3.59
918653	82036	92036	3/4" x 1/2"	3.03
918655	82045	92045	3/4" x 1"	4.59

### Bronze PEX Press Copper Fitting Adapters (PEX Press x Copper Male)

- Use copper fitting adapters to make PEX Press connections between ViegaPEX or FostaPEX tubing and copper fittings. Adapters fit into solder cup or ProPress fittings.
- Lead-free coming soon. Not available as of catalog printing.



Part#	Mfg#	Lead-Free #	Size	Price
918723	87520	97520	1/2"	1.72
918728	87540	97540	3/4"	3.36
918730	87560	97560	1"	5.93

Prices & specifications are subject to change.

Metropolitan Pipe offers Vendor Managed Inventory - never run out of that part again!



# Press Fittings

## Fittings (Continued)

### Bronze PEX Press Copper Fitting Adapters (PEX Press x Copper Male)

Part#	Mfg#	Lead-Free #	Size	Price
918731	87570	97570	1-1/4"	12.84
918732	87580	97580	1-1/2"	17.29
918724	87525	97525	1/2" x 3/4"	2.38
918725	87530	N/A	5/8" x 1/2"	4.24
918726	87531	N/A	5/8" x 3/4"	3.92
918727	87535	97535	3/4" x 1/2"	3.03
918729	87545	97545	3/4" x 1"	4.14

### Bronze PEX Press Copper Tubing Elbows (PEX Press x Copper Male)

- 90° elbows connect ViegaPEX or FostaPEX tubing to copper tubing.
- Lead-free coming soon. Not available as of catalog printing.



Part#	Mfg#	Lead-Free #	Size	Price
918738	89310	99310	1/2"	5.52
918737	89309	99309	3/4"	9.38
918736	89308	99308	1/2" x 3/4"	9.27
918735	89307	99307	1/2" x 3/4"/1/2"	10.61
918740	89312	N/A	5/8" x 3/4"	8.62
918741	89313	N/A	5/8" x 3/4"/1/2"	7.47
918739	89311	99311	3/4" x 3/4"/1/2"	10.72

### Bronze PEX Press Elbows (PEX Press)

- Use elbows for making 90° PEX Press connections in ViegaPEX or FostaPEX runs.
- Lead-free coming soon. Not available as of catalog printing.



Part#	Mfg#	Lead-Free #	Size	Price
918681	83520	93520	1/2"	3.17
918682	83530	N/A	5/8"	4.38
918683	83540	93540	3/4"	4.59
918684	83560	93560	1"	10.83
918685	83570	93570	1-1/4"	23.99
918686	83580	83580	1-1/2"	30.79

### Bronze PEX Press Tees (PEX Press x PEX Press x PEX Press)

- Use these PEX Press tees to join ViegaPEX or FostaPEX tubing. Dimensions are listed as labeled, A x B x C.



- Lead-free coming soon. Not available as of catalog printing.

Part#	Mfg#	Lead-Free #	Size	Price
918687	84020	94020	1/2"	3.96
918690	84030	N/A	5/8"	5.23
918697	84040	94040	3/4"	5.92
918702	84060	94060	1"	13.84
918703	84070	94070	1-1/4"	31.23
918708	84080	94080	1-1/2"	37.47
918688	84021	94021	1/2" x 3/8" x 3/8"	4.73
918689	84022	94022	1/2" x 3/4"	6.07
918691	84032	94032	3/4" x 1/2" x 1/2"	6.07
918692	84034	94034	3/4" x 1/2" x 3/4"	6.17
918693	84036	94036	3/4" x 1/2"	6.17
918694	84037	94037	1" x 1/2" x 1/2"	10.19
918696	84039	94039	1" x 1/2" x 1"	10.61
918695	84038	94038	1" x 3/4" x 1/2"	10.28
918698	84050	94050	1" x 1/2"	10.61
918701	84056	94056	1" x 3/4"	12.50
918707	84074	94074	1-1/4" x 1"	28.66
918712	84084	94084	1-1/2" x 1"	33.00

### Bronze PEX Press Test Plugs (PEX Press)

- Use PEX Press plugs to cap ViegaPEX or FostaPEX tubing with a PEX Press connection for pressure testing or at dead ends.



- Lead-free coming soon. Not available as of catalog printing.

Part#	Mfg#	Lead-Free #	Size	Price
918718	85000	95000	3/8"	1.94
918719	85121	95121	1/2"	1.37
918720	85131	N/A	5/8"	2.47
918721	85141	95141	3/4"	2.49
918722	85161	95161	1"	6.03

Pipe, Fittings, Hardware



## Press Fittings

### Bronze PEX Press Male NPT Adapters (PEX Press x MNPT)

- Use male adapters to make a PEX Press connection between ViegaPEX or FostaPEX tubing and a female NPT thread.
- Lead-free coming soon. Not available as of catalog printing.



Part#	Mfg#	Lead-Free #	Size	Price
918630	80521	90521	1/2"	2.15
918634	80541	90541	3/4"	3.92
918638	80561	90561	1"	6.60
918641	80571	90571	1-1/4"	19.02
918642	80581	90581	1-1/2"	19.42
918629	80506	90506	3/8" x 1/2"	2.71
918631	80526	90526	1/2" x 3/4"	3.16
918632	80527	N/A	5/8" x 1/2"	4.05
918633	80531	N/A	5/8" x 3/4"	4.59
918635	80542	90542	3/4" x 1/2"	3.92
918636	80546	90546	3/4" x 1"	5.71
918639	80562	90562	3/4" x 1-1/4"	13.18
918637	80556	90556	1" x 3/4"	5.37
918640	80566	90566	1" x 1-1/4"	14.11

### Bronze PEX Press Male NPT Elbows (PEX Press x FNPT)

- Use male NPT threaded elbows to make a 90° PEX Press connection between ViegaPEX or FostaPEX tubing and a female NPT thread.
- Lead-free coming soon. Not available as of catalog printing.



Part#	Mfg#	Lead-Free #	Size	Price
918659	82520	92520	1/2"	4.49
918661	82540	92540	3/4"	6.16
918663	82560	92560	1"	10.61
918666	82575	92757	1-1/4"	25.17
918660	82525	92525	1/2" x 3/4"	5.83
918662	82545	92545	3/4" x 1"	10.26
918664	82565	92565	3/4" x 1-1/4"	22.69
918665	82570	92570	1" x 1-1/4"	23.72

### Bronze PEX Press Female NPT Adapters (PEX Press x FNPT)

- Use female adapters to make a PEX Press connection between ViegaPEX or FostaPEX tubing and a male NPT thread.
- Lead-free coming soon. Not available as of catalog printing.



Part#	Mfg#	Lead-Free #	Size	Price
918643	81520	91520	1/2"	4.05

Prices & specifications are subject to change.

### Fittings (Continued)

#### Bronze PEX Press Female NPT Adapters (PEX Press x FNPT)

Part#	Mfg#	Lead-Free #	Size	Price
918645	81540	91540	3/4"	4.59
918647	81560	91560	1"	10.27
918644	81525	91525	1/2" x 3/4"	4.38
918646	81545	91545	1" x 3/4"	8.05

#### Bronze PEX Press Couplings (PEX Press x PEX Press)

- Use these couplings to connect two sections of ViegaPEX or FostaPEX tubing with the PEX Press connection. Use to repair damaged sections or connect long runs.
- Lead-free coming soon. Not available as of catalog printing.



Part#	Mfg#	Lead-Free #	Size	Price
926431	83001	N/A	5/16"	3.42
918667	83000	93000	3/8"	2.51
918668	83020	93020	1/2"	2.39
918670	83040	93040	3/4"	3.92
918669	83030	N/A	5/8"	4.38
918673	83060	93060	1"	7.59
918675	83070	93070	1-1/4"	18.19
918680	83080	93080	1-1/2"	23.88
918671	83050	93050	1/2" x 3/4"	5.94
918672	83055	93055	3/4" x 1"	7.38
918676	83071	93071	3/4" x 1-1/4"	13.18
918677	83072	93072	3/4" x 1-1/2"	18.19
918674	83065	93065	1" x 1-1/4"	14.96
918678	83073	93073	1" x 1-1/2"	19.07
918679	83075	93075	1-1/4" x 1-1/2"	22.54



### Viega Accessories, Fasteners & Tools

#### ViegaPEX J-Clamp Tubing Fasteners

- Use these tubing fasteners anywhere that you need to secure ViegaPEX tubing (studs, joists, subfloor, etc.).
- Nail provided with each clamp.



Part#	Mfg#	Size	Price
907867	52000	3/8"	0.17



## Press Fittings



### Viega Accessories, Fasteners & Tools (Continued)

#### ViegaPEX J-Clamp Tubing Fasteners

Part#	Mfg#	Size	Price
907869	52020	1/2"	0.12
907870	52040	3/4"	0.14

#### U-Channel Fasteners



- Sold in 6.5' lengths, breaks easily into short sections.
- 1/2" and 5/8" tubing clips into channel on 2 inch centers, 3/4" tubing clips into channel on 4 inch centers.
- Great for use near manifolds to keep multiple runs of tubing neat and secure.
- Pre drilled holes allow for fastening to subfloor, insulation and metal decks.

Part#	Mfg#	Size	Price
907228	15310	1/2" PEX	8.55
907229	15311	5/8" PEX	9.56

#### ViegaPEX Snap Clips



- Nylon clips screw in place and tubing snaps in. Clips flex to hold ViegaPEX tubing securely.
- Offered in single and double models.

Part#	Mfg#	Size	Type	Price
907975	58000	5/16"	Single	0.47
907976	58001	5/16"	Double	0.91
907977	58015	3/8"	Single	0.57
907978	58016	3/8"	Double	1.37
907979	58020	1/2"	Single	0.56
907980	58021	1/2"	Double	1.14
907981	58040	3/4"	Single	0.63
907982	58060	1"	Single	1.83

### Viega Lock Clips



- Double ratchet clips allow easy and secure installation of ViegaPEX and FostaPEX tubing.
- Fasteners can be connected to allow neat installation of multiple lines. Clips install quickly using dry wall or wood screws.
- For 5/8" ViegaPEX Barrier use 1/2" Lock Clip.
- For 5/8" FostaPEX use 3/4" Lock Clip.

Part#	Mfg#	Size	Price
907983	58070	5/16"	0.49
907984	58071	3/8"	0.56
907985	58072	1/2"	0.58
907986	58073	3/4"	0.94
907988	58075	1-1/4"	1.87
907989	58076	1-1/2"	3.21

### Wire Mesh Clips



- Clips for fastening 1/2" and 5/8" tubing to wire reinforcing mesh in concrete pours.

Part#	Mfg#	Size	Price
907225	15301	1/2" & 5/8"	0.34

### Viega Hand Press Tools



- With its ratcheting design, the PEX Press tool ensures a complete press connection every time.
- The tool cannot be opened until the fitting has been properly pressed.
- Color coded handles allow easy identification of each size.

Part#	Mfg#	Size	Color	Price
907829	50000	3/8"	Green	205.87
907832	50020	1/2"	Yellow	205.87
907834	50030	5/8"	Red	199.87
907835	50040	3/4"	Blue	205.87
907837	50060	1"	Orange	350.51

### ViegaPEX Plastic Bend Supports



- Plastic bend supports allow tight 90 degree bends to be made in ViegaPEX tubing without kinking.

Part#	Mfg#	Size	Price
907860	51000	3/8"	1.72

Prices & specifications are subject to change.





## Press Fittings



### Viega Accessories, Fasteners & Tools (Continued)

#### ViegaPEX Plastic Bend Supports

Part#	Mfg#	Size	Price
907861	51020	1/2"	1.50
907865	51060	1"	4.62
907866	51070	1-1/4"	8.54
907864	51040	5/8" x 3/4"	2.17

#### Plastic Bend Support For Slab



- Plastic bend supports allow tight bends to be made at concrete entry and exit points and protect ViegaPEX tubing from abrasion.

Part#	Mfg#	Size	Price
907213	15106	3/8"	1.74
907214	15107	1/2"	1.83
907215	15108	5/8" & 3/4"	2.51
907216	15111	1"	3.54

#### Viega Multi Clip

- Use this tubing fastener anywhere you need to support 3/8" through 1" ViegaPEX or FostaPEX tubing (studs, joists, subfloor, etc).
- Self drilling screw provided.



Part#	Mfg#	Size	Price
907868	52006	3/8" - 1"	0.73

#### Zip Ties

- Bag of 100



Part#	Mfg#	Description	Price
907227	15304	Zip Ties	0.10

#### Viega Battery PEX Press Jaws

- PEX Press jaws for use in the Standard & Compact Battery Press Tool make quick work of PureFlow Press system connections.
- Battery Press Tools available from Ridgid Tools



Part#	Mfg#	Size	Type	Price
907936	56073	1/2"	Standard	222.39
907937	56074	5/8"	Standard	222.39
907938	56075	3/4"	Standard	222.39
907939	56076	1"	Standard	222.39

### Viega Accessories, Fasteners & Tools (Continued)

#### Viega Battery PEX Press Jaws

Part#	Mfg#	Size	Type	Price
907941	56081	1-1/2"	Standard	291.83
907927	56053	1/2"	Compact	165.50
907928	56054	5/8"	Compact	165.50
907929	56055	3/4"	Compact	165.50
907930	56056	1"	Compact	165.50
907934	56060	1-1/4"	Compact	209.09
907935	56061	1-1/2"	Compact	231.25

#### Viega PEX Press Tool Set

- These sets of tools allow the user to quickly begin installing the Viega PEX Press System.
- Starter set includes 1/2" and 3/4" PEX Press tools and basic tubing cutter in a convenient carrying case (also available with 1/2" and 3/4" FostaPEX prep tool). The case has three additional slots for adding 3/8", 5/8" and 1" tools as needed.
- The complete heating set includes 3/8", 1/2", 5/8", 3/4" and 1" PEX Press tools, both FostaPEX prep tools and basic tubing cutter in the same case.



Part#	Mfg#	Description	Price
907919	56000	1/2" & 3/4" Starter PEX Kit	452.42
907922	56020	1/2" & 3/4" Starter PEX Kit	517.64
907923	56030	3/8" - 1" Complete PEX Kit	1304.25

#### Tubing Cutter

- Basic tubing cutter allows for an even, square cut.



Part#	Mfg#	Description	Price
907474	21304	Basic - Up to 1" PEX Tubing	21.90

#### Plastic Clips For Foamboard

- Screw clips for fastening 1/2" and 5/8" tubing to foamboard insulation under concrete pours.



Part#	Mfg#	Description	Price
907226	15302	1/2" & 5/8" PEX Clips	0.41
907472	21207	Driver for foamboard screw clips. Handle included for manual use or extension may be used with any cord less drill.	59.66

Prices & specifications are subject to change.

Our office hours are 7am to 4:30pm and counter hours 6am to 4:30pm Monday through Friday.



## Press Fittings

### Viega FostaPEX Prep Tool

- This tool peels the outer PE and aluminum layers from the FostaPEX tubing, allowing it to be compatible with the standard Viega PureFlow PEX Press system.



Part#	Mfg#	Size	Price
907905	54030	1/2" & 3/4"	65.23

### Viega Pneumatic Pex Hammer

- This pneumatic hammer is designed to simplify tubing installations in the both the Climate Trak and Climate Panel systems.
- By applying pressure to the hammer's tip the tool delivers continuous blows to the PEX tubing inserting it into its intended groove.



Part#	Mfg#	Description	Price
907482	21450	Pneumatic PEX Hammer	292.19
907483	21455	Replacement Tip	35.00

### Viega FostaPEX Tubing Bender

- This bending tool for FostaPEX tubing allows clean, neat bends to be made with little effort.
- Will not kink tubing. Formers included for 1/2", 3/4", and 1" FostaPEX.
- Easy one-handed ratchet action with padded handle.
- Steel carrying case.



Part#	Mfg#	Size	Price
907921	56015	1/2", 3/4" & 1"	357.73

### Viega SVC Fitting Wrench



- 30mm (1-3/16") wrench for working with all SVC fitting nuts.
- Low profile 30 degree angled head for easy access to fittings on manifolds or in other locations.

Part#	Mfg#	Size	Price
907830	50002	30mm (1-3/16")	26.49

### Viega Foam Staple Gun



- Manually operated stapler for foamboard insulation.
- 1-1/2" staples hold tubing to 1" foamboard, 2-1/2" staples hold tubing to 2" foamboard.
- 300 staples per box.
- Staples will hold up to 5/8" ViegaPEX Barrier tubing.

Part#	Mfg#	Description	Price
907481	21432	Foam Staple Gun	517.01
907230	15312	Staples - 2-1/2" Length	0.24
907231	15313	Staples - 1-1/2" Length	0.21

### Viega Replacement Purge Valve

- Replacement purge valve for manifolds or stations. Fits 1" NPT manifold end caps.



Part#	Mfg#	Size	Price
907192	15032	1/2" NPT x Hose	13.77



## Climate Panel System

### Viega Multi-Run Climate Panel System

- Viega's newest addition to the Climate Panel System. This system is designed to simplify Climate Panel installations.

- A. Multi-Run Climate Panel – 48" x 12". This panel includes 6 tracks for supply and return lines while also including a row of U-Turns.
- B. Multi-Run Access Piece – 12" x 7". This piece is used to allow the tubing to enter the track of choice on the Multi-Run Climate Panel while allowing the other lines to pass through unobstructed.
- C. Multi-Run Ninety – 12" x 12". This piece is used to make a 90° turn of all 6 lines in the Multi-Run Climate Panel.

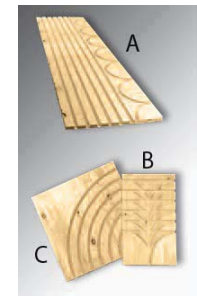

- The Multi-Run Climate Panel Set consists of (5) Multi-Run Climate Panels and (6) Multi-Run Access Pieces. This set is designed to do a 3 circuit (350 sq. ft.) area.

Part#	Mfg#	Description	Price
907168	14050	Climate Panel —7" spacing (A)	22.99

Prices & specifications are subject to change.

Metropolitan Pipe offers FREE DELIVERY in the Greater Boston area.



## Press Fittings



### Climate Panel System (Continued)

#### Viega Multi-Run Climate Panel System

Part#	Mfg#	Description	Price
907169	14055	Access Piece (B)	6.85
907170	14060	Ninety (C)	6.25
907171	14065	Climate Panel Set	155.24

#### Viega Plastic Elbow Sleeve for Climate Panel

- These plastic elbow sleeves are used for tubing protection at all penetration points.



Part#	Mfg#	Description	Price
907212	15104	Plastic Elbow Sleeve with Clip	3.20

#### Viega Compression Coupling

- Low profile compression coupling for 5/16" tubing, specifically for Climate Panel tubing repairs.



Part#	Mfg#	Size	Price
907433	19013	5/16"	10.83

#### Groove Tube



- The Groove Tube supplies a heat transfer paste and adhesive for use with the Climate Panel System and Heat Transfer Plates. Guaranteed compatible with both aluminum and PEX tubing. One tube supplies enough for 20 Climate Panels or 50 Heat Transfer Plates.

Part#	Mfg#	Description	Price
907161	14005	Groove Tube Silicone Heat Transfer Adhesive	6.73

### Viega Climate Trak System

- Upgraded staple up radiant system.
- Extruded heavy gauge aluminum with patented snap-in design.
- Optimal dimension design for quick installation and maximum heat output.
- 3.5" wide x 8' long, or 3.5" wide x 4' long.
- Pre drilled holes for ease of installation.



Part#	Mfg#	Size	Price
907221	15209	3/8" x 4'	7.65
907219	15207	3/8" x 8'	16.90
907222	15210	1/2" x 4'	7.65
907220	15208	1/2" x 8'	16.90

#### Viega Snap Panel

- High density polystyrene grid fastener system.
- For use with 1/2" PEX tubing.



Part#	Mfg#	Size	Price
907223	15211	3' x 5' x 1"	16.18



### Controls, Valves & Actuators

#### Basic Heating Control

- This basic electronic outdoor reset control modulates system water temperature as outdoor temperature fluctuates.
  - Modulating mixing valve control
  - Supply temperature high limit
  - Seasonal pump activation
  - Boiler activation
  - Mixing valve and pump exercising



Part#	Mfg#	Description	Price
907355	16015	Control	442.12



## Press Fittings

### Viega Power head for Stainless Manifolds

- Fits Viega's stainless manifold return valves to provide individual zone control.
- 24 VAC, normally closed. Connects to standard Zone Control or can be wired directly with thermostats.



Part#	Mfg#	Size	Price
907210	15061	24 V, 3 VA	58.81

### Viega Transformers

- These transformers can power thermostats, power heads, actuators, relays, or any other 24 VAC components. Choose size based upon load.

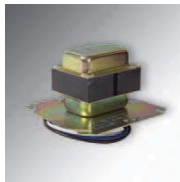

Part#	Mfg#	Size	Price
907413	18008	24 V, 40 VA	38.76
907416	18020	24 V, 75 VA	130.18

### Viega 24 VAC Actuators

- Controls the stations or a diverting valve from a 24 VAC signal.



Part#	Mfg#	Description	Price
907412	18005	2 Position (Open/Closed)	137.50
907411	18003	3 Position (Floating)	182.91

### Viega Bronze 3-Way Diverting Valves

- Three way diverting valves for temperature control in many heating and snow melting applications.
- Includes solder tailpieces.



Part#	Mfg#	Size	Price
907453	20001	3/4"	229.63
907454	20002	1"	277.72

### Viega Bronze Spring Check Valves (FNPT)

- Spring check valves ensure proper flow direction by preventing gravity circulation or backflow.
- These compact valves can be installed in any direction (vertically or horizontally).
- Constructed of all non-ferrous components for corrosion resistance.



Part#	Mfg#	Size	Price
907467	20201	1/2"	12.96
907468	20202	3/4"	17.62
907469	20203	1"	25.70
907470	20204	1-1/4"	38.50
907471	20205	1-1/2"	48.40

### Viega Outlet Boxes

- Wall-mounted box for ice maker / washing machine connections.
- 1/4 turn PEX Press valve included.



Part#	Mfg#	Description	Price
907953	57100	Ice Maker Outlet Box with 1/2" PEX Press Valve	19.61
907954	57101	Washing Machine Outlet Box with 1/2" PEX Press Valves (with Color-coded Valve Handles)	29.18

### Stainless Manifold - Shut Off/Balancing

- These pre assembled 1-1/4" diameter stainless supply and return manifolds come attached to two 6-5/8" spacing brackets for compact remote mounting.
- This stainless manifold provides shutoff and balancing valves for each circuit.
- Manifold is used with flow rates up to 2 GPM per circuit with a maximum of 18 GPM.
- The air bleeders and purge valves are connected and factory tested.
- 1-1/4" Union connection, 1" NPT removable end caps.
- Circuit connection fittings are sold separately.



Part#	Mfg#	Size	Price
907233	15700	2	167.57
907234	15701	3	207.90
907235	15702	4	248.24
907236	15703	5	288.58
907237	15704	6	328.92
907238	15705	7	369.26
907239	15706	8	409.60



## Press Fittings

### Controls, Valves & Actuators (Continued)

#### Stainless Manifold - Shut Off/Balancing

Part#	Mfg#	Size	Price
907241	15708	10	456.23

#### Stainless Manifold Ball Valve Set



Part#	Mfg#	Size	Price
907206	15056	1-1/4" MNPT x 1" FNPT	60.51

#### Stainless Manifold Outlet Caps



- Used to seal extra outlets on Stainless Steel Manifolds.

Part#	Mfg#	Description	Price
907204	15054	Manifold Outlet Cap	9.31
907203	15053	Manifold End Plug	9.31

#### SVC Bronze Compression PEX Adapters (PEX x SVC)



Part#	Mfg#	Size	Price
907427	19007	5/16"	7.30
907428	19008	3/8"	7.30
907429	19009	1/2"	7.30
907430	19010	5/8"	8.48
907431	19011	3/4"	13.10

#### Viega Bronze SVC Press Adapters (PEX x SVC)



Part#	Mfg#	Size	Price
907449	19408	3/8"	5.81
907450	19409	1/2"	5.81
907451	19410	3/4"	8.57
907452	19413	5/8"	7.01

#### Automatic Air Vent

- Automatic air vent can be used as an alternative for air bleeder on stainless manifolds.
- Air vent should be mounted on the supply header.



Part#	Mfg#	Description	Price
907198	15040	Air Vent	17.27

#### Stainless Manifold Expansion Set

##### Shut Off/Balancing

- These stainless manifold extensions attach to stainless manifolds to add circuits.
- Expansion set comes with balancing valve on supply and shut off valve on return manifold.
- 1-1/4" M NPT x 1" M NPT adapter included in set.



Part#	Mfg#	Description	Price
907207	15058	Stainless Manifold Expansion Set (Shut off/balancing)	80.22

#### Stainless Manifold Expansion Set

##### Shut Off/Balancing/Flow Meter

- These stainless manifold extensions attach to stainless manifolds to add circuits.
- Expansion set comes with balancing valve/flow meter on supply and shut off valve on return manifold.
- 1-1/4" M NPT x 1" M NPT adapter included in set.



Part#	Mfg#	Description	Price
907208	15059	Stainless Manifold Expansion Set (Shut off/balancing/flow meters)	96.28

#### Circuit Ball Valve

- Attach to valve seats on manifolds to provide individual circuit shut-off capability.
- Useful for purging one circuit at a time, or for circuit shut-off on 1-1/2" brass manifolds and stainless manifold valveless.



Part#	Mfg#	Description	Price
907191	15031	Circuit Ball Valve	14.51

Prices & specifications are subject to change.

We offer a variety of GREEN products such as flush valves, faucets, showerheads & more!



## Press Fittings

### ProRadiant SYSTEMS

#### Manabloc

- Bronze PEX Press MANABLOCs provide a home-run distribution manifold for the plumbing system.
- These MANABLOCs utilize either 3/8" or 1/2" distribution lines.
- Each MANABLOC comes factory pre-assembled with color coded hot and cold ports.
- All Bronze PEX Press MANABLOCs include press connections, drill templates, instruction guide, faceplate and port labels.
- Supply connections and mounting straps need to be ordered separately.

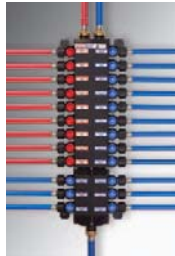

Part#	Mfg#	Size	Price
908829	MXBD303XP	30 Ports: 1/2" (12 hot, 18 cold)	Call
907780	45716	Set of 2 Mounting Straps	2.99
907846	50601	Red Valve T-Handle	0.69

#### PEX Press Supply Adapters

- These fittings connect the supply lines to the MANABLOC.
- They allow you to easily connect ViegaPEX or FostaPEX tubing to the MANABLOC with Bronze PEX Press connections (nut included).



Part#	Mfg#	Size	Price
907591	33304	3/4"	6.43

#### PEX Press Port Adapters

- This adapter connects to the distribution ports on a MANABLOC and allows you to connect to ViegaPEX or FostaPEX tubing using a Bronze PEX Press connection (nut included)



Part#	Mfg#	Size	Price
907596	33334	1/2"	2.61

#### System Pressurization Kit

- Pressurization kit for Viega stations or manifolds. Connects to purge valve or SVC fitting.
- Two 1-1/4" M NPT x 1" F NPT Reducers and two 1" NPT plugs included for testing remote manifolds.



Part#	Mfg#	Description	Price
907473	21210	System Pressurization Kit	64.61



## Custom Reporting

Need a year's worth of your purchase history? No problem! Our custom reporting capabilities allow us to get you the information you need – quickly.



## Gas Fittings

### FlashShield Gas Tubing & Fittings

- Metal mesh layer dissipates electricity
- New fittings provide continuity with metal mesh
- NO additional manufacturer bonding required
- **MA approved**



### FlashShield Corrugated Stainless Steel Tubing

- CSST flexible gas piping supplies natural gas or liquefied petroleum gas to appliances.
- Flexibility and durability allows for simple routing through complex building structures and designs.
- Pre-marked by the foot for easy measuring and installation.
- Annealed 304 stainless steel makes tubing more flexible than brands not heat-treated.



Part #	Mfg #	Size	Coil Length	Price
941433	FS-8-50	1/2"	50'	Call
941434	FS-8-125	1/2"	125'	Call
941435	FS-11-50	3/4"	50'	Call
941436	FS-11-125	3/4"	125'	Call
941438	FS-16-50	1in	50'	Call

### FlashShield Gas Fittings

- Tool-less flare design; no special tools are required.
- Metal-to-metal seal, with no split rings, O-rings or gaskets.
- Self-guiding assembly to ensure a perfectly even flare.
- Exclusive, patented Jacket-Lock fitting eliminates exposed stainless steel beyond the nut.
- All components are fully reusable.

### FlashShield Straight Fittings (Adapter/Nut/Bushing)

- Straight Fittings connect the flexible gas tubing to gas supply, distribution manifolds or gas appliances.
- Fitting adapter, bushings and nut - Brass.
- Square Flange - Steel with zinc coating.



Part #	Mfg #	Size	Price
941439	FSFTG-8-24	1/2" NPT	Call
941445	FSFTG-11-24	3/4" NPT	Call
941446	FSFTG-16-12	1in NPT	Call

### FlashShield Coupling Fittings

- Couplings allow for the splicing and additions to the flexible gas tubing.
- Fitting adapter, bushings and nut - Brass.



Part #	Mfg #	Size	Price
941447	FSFTG-8-12	1/2" NPT	Call
941448	FSCPL-11-12	3/4" NPT	Call
941449	FSCPL-16-6	1in NPT	Call

### FlashShield Termination Fittings (Flange/Adapter/Nut/Bushing)

- Termination Fittings create a fixed point "stub-out" on a wall or floor surface.
- Fitting adapter, bushings and nut - Brass.
- Square Flange - Steel with zinc coating.



Part #	Mfg #	Size	Price
941450	FSTRM-8-12	1/2" NPT	Call
941451	FSTRM-11-12	3/4" NPT	Call
941452	FSTRM-16-6	1in NPT	Call

### FlashShield Termination Bracket Fittings (Bracket/Adapter/Nut/Bushing)

- Termination Bracket Fittings provide a secure attachment point for key-valves and as an alternate termination.
- Fitting adapter, bushings and nut - Brass.
- Square Flange - Steel with zinc coating.



Part #	Mfg #	Size	Price
941455	TRMBKT-8-12	1/2" NPT	Call
941456	TRMBKT-11-12	3/4" NPT	Call
941457	TRMBKT-16-6	1in NPT	Call

### FlashShield Stubs

- All Stubs create a fixed point "stub-out" on a wall or floor surface for meter and appliance attachment.
- Schedule 40 steel pipe complying with material standard ASTM A-53.
- Exterior plating - Black oxide coating after all threading, forming and welding.



Part #	Mfg #	Size	Price
941459	STUB-11-11-30	3/4" NPT	Call
941460	STUB-8-10	1/2" NPT	Call



## Brass Compression Fittings



### Brass Compression Fittings

#### Female Adapters (Compression OD x F)



Part #	Size	Price
6187	1/4"	1.77
6188	3/8"	2.06
6199	1/2"	2.91
6191	1/4" x 1/8"	1.26
6192	1/4" x 3/8"	3.45
6193	1/4" x 1/2"	4.48
6196	3/8" x 1/4"	2.02
6197	3/8" x 1/2"	2.34
6198	1/2" x 3/8"	14.48
6201	5/8" x 1/2"	3.66

#### Male Adapters (Compression OD x MIP)



Part #	Size	Price
6202	1/8"	1.16
6209	1/4"	1.41
6217	3/8"	1.92
6203	1/2"	2.73
6206	3/16" x 1/8"	3.90
6207	3/16" x 1/4"	1.78
6208	1/4" x 1/8"	1.13
6210	1/4" x 3/8"	1.99
6211	1/4" x 1/2"	3.16
6212	5/16" x 1/8"	1.36
6213	5/16" x 1/4"	1.62
6214	5/16" x 3/8"	2.50
6215	3/8" x 1/8"	1.65
6216	3/8" x 1/4"	1.54
6218	3/8" x 1/2"	2.44
6219	3/8" x 3/4"	4.88
6220	1/2" x 1/4"	2.43
6221	1/2" x 3/8"	2.38
6205	1/2" x 3/4"	4.79
6222	5/8" x 3/8"	3.22
6223	5/8" x 1/2"	3.09
6224	5/8" x 3/4"	5.00
6204	3/4" x 3/4"	7.73
92265	7/8" x 1/2"	32.39
6225	7/8" x 3/4"	6.32

### Brass OD Compression Caps



Part #	Size	Price
6283	1/4"	0.54
6284	3/8"	0.65
6285	5/8"	2.77

### Brass 90° Elbows (Compression OD x FIP)



Part #	Size	Price
6236	1/4"	4.20
6237	1/2"	7.48
6239	1/4" x 1/8"	3.32
6240	3/8" x 1/4"	4.46
6241	3/8" x 1/2"	5.33

### Brass 90° Elbows (OD Comp x OD Comp)



Part #	Size	Price
6228	1/4" x 1/4"	3.04
6229	5/16" x 5/16"	4.56
6230	3/8" x 3/8"	3.88
6231	1/2" x 1/2"	6.02
6232	5/8" x 5/8"	7.81
6234	7/8" x 7/8"	31.28

### Brass 90° Elbows (OD Compression x MIP)



Part #	Size	Price
6243	1/8"	2.19
6249	1/4"	2.36
6244	3/8"	3.40
6245	1/2"	5.75
6246	3/16" x 1/8"	2.09
6248	1/4" x 1/8"	2.02
6250	1/4" x 3/8"	3.85
6251	5/16" x 1/8"	2.59
6252	5/16" x 1/4"	3.12
6253	5/16" x 3/8"	4.77
6254	3/8" x 1/8"	3.42
6255	3/8" x 1/4"	2.97
6256	3/8" x 1/2"	4.99
6258	1/2" x 3/8"	4.93
6259	5/8" x 3/8"	6.49

### Brass 90° Elbows (OD Compression x MIP) (Continued)

Part #	Size	Price
6260	5/8" x 1/2"	7.29

### Brass OD Compression Nuts



Part #	Size	Price
6154	1/8"	0.27
6155	3/16"	0.61
6156	1/4"	0.38
6157	5/16"	0.42
6158	3/8"	0.48
6159	1/2"	0.80
6160	5/8"	1.04
180720	3/4"	2.55
6161	7/8"	2.41

### OD Pilot Line Nut (Breakaway)

Part #	Size	Price
157838	1/4"	1.08

### Brass OD Compression Tees



Part #	Size	Price
6261	1/8"	9.44
6262	3/16"	4.58
6263	1/4"	3.87
6264	5/16"	5.85
6265	3/8"	4.75
6266	1/2"	7.95
6267	5/8"	11.35
6268	7/8"	43.51

### Brass OD Compression Unions (OD x OD)



Part #	Size	Price
6171	1/8"	1.49
6172	3/16"	1.58
6173	1/4"	1.64
6174	5/16"	1.98
6175	3/8"	2.12
6176	1/2"	3.40
6177	5/8"	4.54

Prices & specifications are subject to change.





## Brass Compression Fittings

### Brass OD Compression Unions (OD x OD) (Continued)

Part #	Size	Price
6178	7/8"	10.18
6182	3/8" x 1/4"	2.11
6183	1/2" x 3/8"	3.13
6184	5/8" x 3/8"	3.85
6185	5/8" x 1/2"	4.65

### Brass Adapters (Sweat x OD Comp)



Part #	Size	Price
11964	1/2" x 1/4"	3.52
11966	1/2" x 3/8" Delta	1.85
11967	1/2" x 1/2"	7.71

### Brass OD Compression Sleeves



Part #	Size	Price
6162	1/8"	0.15
6163	3/16"	0.14
6164	1/4"	0.11
6165	5/16"	0.14
6166	3/8"	0.14
6168	1/2"	0.28
6169	5/8"	0.35
6170	3/4"	0.89
53055	7/8"	1.02

### OD Compression Plugs



Part #	Size	Price
6279	1/4"	2.67
6280	3/8"	2.05

### Compression Sleeves



Part #	Size	Price
136676	1/4" OD Plastic	0.19
6167	3/8" OD Plastic	0.30

### Brass Compression Inserts

- Not for use with PEX piping



Part #	Size	Price
136678	1/4" OD	0.17
136677	3/8" OD	0.26

### Chrome-Plated Brass Compression Fittings

#### CP 90° Elbows (OD Comp x MIP)



Part #	Size	Price
11976	3/8" x 1/2"	19.62

#### CP OD Compression Nuts



Part #	Size	Price
11985	3/8"	0.65
11986	1/2"	1.08

#### CP OD Compression Unions



Part #	Size	Price
11958	3/8"	2.92
55669	5/8" x 3/8"	33.34

#### CP Adapters - Drill Through (OD Comp x FIP)



Part #	FIP x OD	Price
11959	3/8"	2.44
11960	3/8" x 1/2"	20.01

#### CP Adapters - Drill Through (OD Comp x MIP)



Part #	MIP x OD	Price
11961	3/8"	2.33
11970	1/2"	14.78
11963	3/8" x 1/2"	2.95



### CP Adapters (Sweat x OD Comp)



Part #	Nom Swt x OD	Price
11965	1/2" x 3/8"	2.35

### Brass Flare Fittings



### Brass Flare Fittings

#### Brass OD Flare Adapters (OD Flare x FIP)



Part #	Size	Price
6310	1/4"	1.35
6311	3/8"	1.76
6317	1/4" x 1/8"	0.87
6318	1/4" x 3/8"	3.18
6312	3/8" x 1/2"	2.39
6314	1/2" x 3/8"	1.99

#### Brass OD Flare Adapters (OD Flare x MIP)



Part #	Size	Price
6332	1/4" x 1/2"	2.50

#### Brass OD Flare Seal Caps



Part #	Size	Price
6375	1/4"	0.46
6376	3/8"	0.79
6377	1/2"	1.19

#### Brass Flare 45° Elbows (OD Flare x MIP)

Part #	Size	Price
168035	3/8"	4.77

#### Brass OD Flare 90° Elbows (OD Flare x OD Flare)



Part #	Size	Price
6344	1/4"	7.32
6346	3/8"	3.61

Prices & specifications are subject to change.

Metropolitan Pipe offers FREE DELIVERY in the Greater Boston area.



## Brass Flare Fittings

### Brass OD Flare 90° Elbows (OD Flare x OD Flare) (Continued)

Part #	Size	Price
6348	5/8"	7.35

### Brass OD Flare 90° Elbows (OD Flare x MIP)



Part #	Size	Price
6350	1/4"	2.53
6355	3/8"	3.53
6359	1/2"	5.23
6349	1/4" x 1/8"	4.51
6352	3/8" x 1/4"	3.08
6357	3/8" x 1/2"	4.47
112413	1/2" x 1/4"	12.65
6358	1/2" x 3/8"	4.26
6361	5/8" x 1/2"	6.35

### Brass OD Flare Short Nuts



Part #	Size	Price
6287	1/8"	0.80
6288	1/4"	0.67
6289	5/16"	0.90
6290	3/8"	0.95
6291	1/2"	1.36
6292	5/8"	2.07
6293	3/4"	6.52
6294	7/8"	9.38

### Brass OD Flare Long Forged Nuts



Part #	Size	Price
6295	1/4"	0.87
6296	3/8"	1.68
6297	1/2"	2.60

### Brass OD Flare Plugs



Part #	Size	Price
6371	1/4"	0.71

### Brass OD Flare Tees (OD Flare x OD Flare x OD Flare)



Part #	Size	Price
6363	1/4"	3.10
6365	3/8"	4.49
6366	1/2"	6.13
6367	5/8"	9.62

### Brass OD Flare Unions (OD Flare x OD Flare)



Part #	Size	Price
6301	1/4"	0.79
6302	3/8"	1.42
6304	1/2"	2.24
6305	5/8"	3.41

### Brass OD Flare Half-Unions (OD Flare x MIP)



Part #	Size	Price
6323	1/4"	0.98
6335	3/8"	1.41
6327	1/2"	2.13
6328	3/4"	6.71
6330	1/4" x 1/8"	0.70
6331	1/4" x 3/8"	1.45
6325	5/16" x 1/4"	1.17
6333	3/8" x 1/8"	4.96
6334	3/8" x 1/4"	1.17
6336	3/8" x 1/2"	1.94
6337	1/2" x 1/4"	1.90
6338	1/2" x 3/8"	1.86
6341	5/8" x 1/2"	2.65



**LET-LOK**

### Compression Tube Fittings Tube Compression Tees

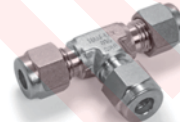

### Brass Tees

Part #	Mfg #	Size	Price
917471	764L	1/4" OD	9.22
917473	764L	3/8" OD	10.28
919071	764L	1/2" OD	15.26
919073	764L	3/4" OD	24.70
918390	764L	5/8" OD	19.40
919075	764L	1in OD	49.61

### Stainless Steel Tees

Part #	Mfg #	Size	Price
919069	764L	1/8" OD	26.79
915325	764L	1/4" OD	24.98
915327	764L	3/8" OD	32.53
915328	764L	1/2" OD	49.49
915329	764L	5/8" OD	57.80
915330	764L	3/4" OD	74.00
919070	764L	1in OD	158.27

### Tube Compression Tee - Male Run



### Stainless Steel Male Run Tees

Part #	Mfg #	Size	Price
915541	771L	1/4" OD	30.73
915542	771L	3/8" OD	36.02
915543	771L	1/2" OD	52.81



## Tube Compression Fittings



### Tube Compression Tee - Female Branch



#### Stainless Steel Female Branch Tees

Part #	Mfg #	Size	Price
915547	772LF	1/4" OD	35.87
915549	772LF	3/8" OD	41.02
915550	772LF	1/2" OD	59.92

### Tube Compression Crosses



#### Stainless Steel Crosses

Part #	Mfg #	Size	Price
919217	7102L	1/8" OD	48.11
915554	7102L	1/4" OD	45.09
915555	7102L	3/8" OD	55.99
915556	7102L	1/2" OD	65.06

### Tube Compression 90-Elbows



#### Brass 90-Elbows

Part #	Mfg #	Size	Price
917470	765L	1/4" OD	5.72
919077	765L	3/8" OD	7.63
919079	765L	1/2" OD	11.13
919082	765L	5/8" OD	13.89
919083	765L	3/4" OD	20.56
919084	765L	1in OD	38.16

#### Stainless Steel 90-Elbows

Part #	Mfg #	Size	Price
919076	765L	1/8" OD	16.50
915332	765L	1/4" OD	17.71
915333	765L	3/8" OD	21.63
915334	765L	1/2" OD	35.55
915335	765L	5/8" OD	39.80
915336	765L	3/4" OD	62.81
915337	765L	1in OD	120.14

### Tube Compression x Male 90-Elbow



#### Brass Comp x Male 90-Elbow

Part #	Mfg #	Size	Price
919212	769L	1/4" x 1/4" OD	5.62
919213	769L	3/8" x 3/8" OD	7.31
919214	769L	1/2" x 1/2" OD	8.90
919215	769L	5/8" x 1/2" OD	11.34
919216	769L	3/4" x 3/4" OD	14.84

#### Stainless Comp x Male 90-Elbow

Part #	Mfg #	Size	Price
915513	769L	1/4" x 1/4" OD	14.99
915514	769L	1/4" x 3/8" OD	21.04
916701	769L	3/8" x 1/4" OD	18.60
915516	769L	3/8" x 3/8" OD	22.09
919792	769L	3/8" x 1/2" OD	28.76
915517	769L	1/2" x 1/2" OD	32.85
915518	769L	5/8" x 1/2" OD	36.17
915520	769L	3/4" x 3/4" OD	39.94
915521	769L	1in x 1in OD	77.94

### Tube Compression x Female 90-Elbow



#### Stainless Comp x Female 90-Elbow

Part #	Mfg #	Size	Price
915537	770L	1/4" x 1/4" OD	21.04
915538	770L	1/4" x 3/8" OD	30.57
915539	770L	3/8" x 3/8" OD	24.36
915540	770L	1/2" x 1/2" OD	39.64

### Tube Compression Unions



#### Brass Unions

Part #	Mfg #	Size	Price
917469	762L	1/4" OD	3.29
917467	763L	1/4" x 1/8" OD	3.71

## Compression Tube Fittings

### Tube Compression Unions

#### Brass Unions (Continued)

Part #	Mfg #	Size	Price
918944	762L	3/8" OD	4.56
919065	763L	3/8" x 1/4" OD	4.56
919058	762L	1/2" OD	10.81
919066	763L	1/2" x 3/8" OD	7.84
919059	762L	5/8" OD	10.81
919067	763L	5/8" x 1/2" OD	11.02
919061	762L	3/4" OD	12.83
919068	763L	3/4" x 1/2" OD	12.93
919062	762L	1in OD	23.11

#### Stainless Steel Unions

Part #	Mfg #	Size	Price
919057	762L	1/8" OD	12.26
915245	762L	1/4" OD	12.11
915257	763L	1/4" x 1/8" OD	12.87
915248	762L	3/8" OD	17.42
919063	763L	3/8" x 1/8" OD	19.06
915258	763L	3/8" x 1/4" OD	17.42
915249	762L	1/2" OD	25.89
915260	763L	1/2" x 1/4" OD	26.79
915262	763L	1/2" x 3/8" OD	26.79
915250	762L	5/8" OD	33.59
915290	763L	5/8" x 1/2" OD	34.50
915261	763L	5/8" x 3/8" OD	35.10
42314	762L	3/4" OD	41.92
915291	763L	3/4" x 1/2" OD	40.86
915324	763L	3/4" x 5/8" OD	48.41
42312	762L	1in OD	69.75
919064	763L	1in x 3/4" OD	74.92

### Tube Compression x Female Adapter



#### Brass Comp x Female Adapter

Part #	Mfg #	Size	Price
917477	766L	1/4" x 1/4" OD	3.50
919098	766L	3/8" x 3/8" OD	4.56
917476	766L	1/2" x 1/2" OD	7.84
919099	766L	5/8" x 1/2" OD	8.80

Prices & specifications are subject to change.

Metropolitan Pipe offers Vendor Managed Inventory - never run out of that part again!



# Tube Compression Fittings

## Compression Tube Fittings

### Tube Compression x Female Adapter

#### Brass Comp x Female Adapter (Continued)

Part #	Mfg #	Size	Price
919100	766L	3/4" x 3/4" OD	10.92
919101	766L	1in x 1in OD	23.11

#### Stainless Comp x Female Adapter

Part #	Mfg #	Size	Price
919085	766L	1/8" x 1/8" OD	10.44
919086	766L	1/8" x 1/4" OD	12.11
919088	766L	1/4" x 1/8" OD	10.14
919090	766L	1/4" x 3/8" OD	15.60
919091	766L	1/4" x 1/2" OD	17.42
919092	766L	3/8" x 1/4" OD	13.01
915338	766L	3/8" x 3/8" OD	17.26
919094	766L	3/8" x 1/2" OD	22.69
915339	766L	1/2" x 1/2" OD	25.43
919095	766L	5/8" x 1/2" OD	26.93
919096	766L	3/4" x 3/4" OD	34.06
919097	766L	1in x 1in OD	72.79

### Tube Compression x Male Adapters



#### Brass Comp x Male Adapters

Part #	Mfg #	Size	Price
917494	768L	1/4" x 1/8" OD	2.76
917495	768L	1/4" x 1/4" OD	2.76
915347	768L	1/4" x 3/8" OD	3.39
917474	768L	1/4" x 1/2" OD	5.09
918391	768L	5/8" x 1/2" OD	6.78
919181	768L	3/8" x 3/8" OD	3.71
919182	768L	3/8" x 1/4" OD	3.29
919185	768L	3/8" x 1/2" OD	5.19
919188	768L	1/2" x 3/8" OD	5.72
917475	768L	1/2" x 1/2" OD	6.36
919190	768L	1/2" x 3/4" OD	8.16
919192	768L	5/8" x 3/4" OD	8.06
919193	768L	3/4" x 3/4" OD	8.80
919194	768L	1in x 1in OD	16.43

### Stainless Comp x Male Adapters

Part #	Mfg #	Size	Price
919105	768L	1/8" x 1/8" OD	8.16
919108	768L	1/8" x 1/4" OD	9.22
918910	768L	1/8" x 3/8" OD	14.39
915350	768L	1/4" x 1/8" OD	7.56
915348	768L	1/4" x 1/4" OD	7.88
918860	768L	1/4" x 3/8" OD	9.99
917462	768L	1/4" x 1/2" OD	13.47
919796	768L	3/8" x 1/4" OD	10.76
915505	768L	3/8" x 3/8" OD	12.11
915508	768L	3/8" x 1/2" OD	14.53
919142	768L	1/2" x 1/4" OD	15.60
919145	768L	1/2" x 3/8" OD	16.20
915509	768L	1/2" x 1/2" OD	18.02
919146	768L	1/2" x 3/4" OD	23.16
915510	768L	5/8" x 1/2" OD	19.98
919156	768L	5/8" x 3/4" OD	24.81
915511	768L	3/4" x 1/2" OD	26.18
915512	768L	3/4" x 3/4" OD	27.54
917616	768L	7/8" x 3/4" OD	47.67
919173	768L	1in x 1/2" OD	48.27
919174	768L	1in x 3/4" OD	50.69
915349	768L	1in x 1in OD	48.27

### Tube Compression x Port Adapter



#### Stainless Comp x Port Adapters

Part #	Mfg #	Size	Price
919102	767LT	1/8" x 1/4" OD	9.99
915341	767LT	1/4" x 1/8" OD	13.31
915342	767LT	1/4" x 3/8" OD	10.14
915343	767LT	3/8" x 1/4" OD	13.31
915344	767LT	3/8" x 1/2" OD	13.92
919103	767LT	1/2" x 1/4" OD	19.81
915345	767LT	1/2" x 3/8" OD	16.95
915346	767LT	1/2" x 5/8" OD	17.55
919104	767LT	5/8" x 3/4" OD	35.12

### Tube Compression Plugs



#### Brass Plugs

Part #	Mfg #	Size	Price
919341	7121L	1/4" OD	1.70
919342	7121L	3/8" OD	2.23
919343	7121L	1/2" OD	3.50
919344	7121L	5/8" OD	3.82
919345	7121L	3/4" OD	4.35

#### Stainless Steel Plugs

Part #	Mfg #	Size	Price
919337	7121L	1/8" OD	7.73
915568	7121L	1/4" OD	6.05
915569	7121L	3/8" OD	6.82
915570	7121L	1/2" OD	10.14
919338	7121L	5/8" OD	13.92
919339	7121L	3/4" OD	16.20
919340	7121L	1in OD	32.85

### Tube Compression Caps



#### Brass Caps

Part #	Mfg #	Size	Price
919222	7108L	1/4" OD	1.70
919224	7108L	3/8" OD	2.54
919225	7108L	1/2" OD	3.82
919226	7108L	5/8" OD	4.13

#### Stainless Steel Caps

Part #	Mfg #	Size	Price
919221	7108L	1/8" OD	7.26
915562	7108L	1/4" OD	6.20
915563	7108L	3/8" OD	8.47
915564	7108L	1/2" OD	12.41
915565	7108L	5/8" OD	14.99
915566	7108L	3/4" OD	20.14
915567	7108L	1in OD	37.51

Pipe, Fittings, Hardware

Prices & specifications are subject to change.



## Tube Compression Fittings



### Tube Compression Nuts



**Stainless Steel Nuts**

Part #	Mfg #	Size	Price
920685	761L	1/8" OD	2.58
915317	761L	1/4" OD	2.29
915318	761L	3/8" OD	3.18
915319	761L	1/2" OD	5.30
915321	761L	5/8" OD	7.42
915322	761L	3/4" OD	8.78
915323	761L	1in OD	16.79

### Tube Compression Ferrules

- Package of 10

#### Stainless Steel Ferrules

Part #	Mfg #	Size	Price
915301	760LS	1/4" OD	22.84
919049	760LS	1/8" OD	27.17
915294	760LS	3/8" OD	28.85
915296	760LS	1/2" OD	40.99
915297	760LS	3/4" OD	69.12
915298	760LS	1in OD	115.16

### Tube Compression High Performance Ball Valve - Brass

- The H6800 Series is a high performance instrumentation ball valve for general service and instrumentation panels. The valves offer tight shutoff, long-life service and low operating torque. The H6800 Series is rated to max. 6000 psig and performs on/off or diverter service

- 3 Piece
- Plastic Handle



Part #	Mfg #	Size	Price
919401	H-6800	1/4" OD	69.82
918945	H-6800	3/8" OD	92.47
919402	H-6800	1/2" OD	143.97

### Tube Compression Ball Valve - Stainless Steel

- The H700 Series is a moderate pressure ball valve for general services. These valves are compact in size and structure. They have relatively large ports for high flow, tight shutoff, long-life service and low operating torque. Can be used for bi-directional flow. The series is rated to max. 2000 psig (135 bar) and performs on/off service.



Part #	Mfg #	Size	Price
919398	H-700	1/4" OD	63.67
918996	H-700	3/8" OD	74.92
919399	H-700	1/2" OD	92.75

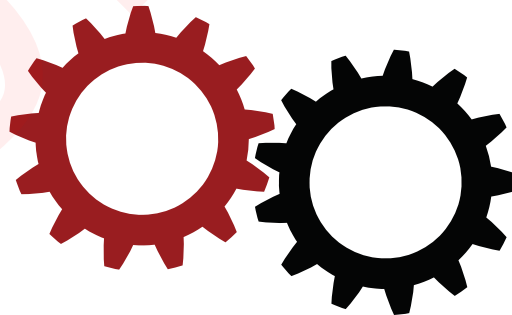

## Valve Actuation

Our in-house valve actuation shop is equipped to add actuators (both pneumatic and electric) to many different sizes and types of valves.



## Twist & Lock Fittings



### CTS Twist & Lock Fittings

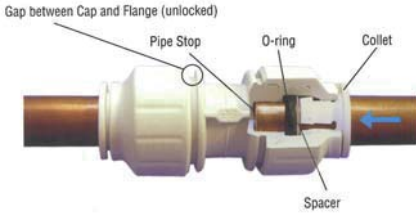

- Push-fit connections
- Suitable for use with Pex, CPVC and Copper pipe
- Hot and cold water and Hydronic Heating applications
- Lead Free and Non Toxic
- Truly demountable without damage to pipe or fitting
- No risk of fire or flames
- Corrosion free and no scale build-up

### Copper Tube Size Union Tees



Part #	Size	Price
932956	1/2"	5.54
932776	3/4"	9.24
932777	1"	17.34

### Copper Tube Size Reducing Tees



Part #	Size	Price
932926	3/4" x 1/2"	8.78
932927	3/4" x 1/2" x 1/2"	8.10
932942	1/2" x 3/4"	8.10
932943	3/4" x 1/2" x 3/4"	8.78

### Copper Tube Size Union Elbows



Part #	Size	Price
932779	1/2"	5.40
932789	3/4"	8.13
932791	1"	13.64

### Copper Tube Size Stem Elbows



Part #	Size	Price
932773	1/2" stem x 1/2"	3.79
932925	3/4" stem x 3/4"	5.30

### Copper Tube Size Couplings



Part #	Size	Price
932794	1/2"	4.72
932795	3/4"	6.20
932796	1"	12.03

### Copper Tube Size Reducing Couplings



Part #	Size	Price
932894	3/4" x 1/2"	9.54
932895	1" x 3/4"	8.83

### Copper Tube Size Reducers



Part #	Size	Price
932892	3/4" stem x 1/2"	3.57
932893	1" stem x 3/4"	7.05

### Copper Tube Size Test Caps



Part #	Size	Price
932945	1/2"	3.86
932944	3/4"	4.87
932946	1"	7.83

### Copper Tube Size Female Swivel Connector



Part #	Size	Price
932947	1/2" x 1/2"	6.73

### Copper Tube Size Pipe Inserts



Part #	Size	Price
Call	1/2"	Call
Call	3/4"	Call
Call	1"	Call

*Easy to Connect*



*Easy to Disconnect*



- No tools
- No sweating
- No threading



## Twist & Lock Fittings



### Polyethylene Fittings

- Manufactured in white polypropylene with food grade EPDM o-rings.
- Working Pressures and Temperatures:
- Water Max. 150psi at 70°F (10 bar at 20°C)
- Max. 60psi at 140°F (4 bar at 60°C)
- Min. 33°F/1°C

#### Union Elbows



Part #	Tube OD	Price
933006	1/4"	2.34
933008	5/16"	2.51
933010	3/8"	3.58
933011	1/2"	4.27

#### Street 90-Elbows



Part #	Stem OD x Tube OD	Price
933150	1/4"	2.12
933151	3/8"	3.58
933152	1/2"	4.38

#### Male 90-Elbow



Part #	Tube OD x NPTF	Price
933158	1/4"	2.39
933159	3/8"	6.42

#### Union Tees



Part #	Tube OD	Price
933007	1/4"	2.97
933004	5/16"	3.21
933005	3/8"	3.63
933002	1/2"	4.56

### Union Couplings



Part #	Tube OD	Price
933015	1/4"	2.06
933017	5/16"	2.25
933019	3/8"	2.79
933020	1/2"	3.29

### Male Adapters



Part #	Tube OD x NPTF	Price
932957	1/4"	1.52
932965	3/8"	2.11
932969	1/2"	3.87
932924	1/4" x 1/8"	1.34
932963	1/4" x 3/8"	2.11
932964	3/8" x 1/4"	1.52
933163	3/8" x 1/2"	4.12
932967	1/2" x 3/8"	3.58

### Female Adapters



Part #	Tube OD x NPTF	Price
933153	1/4"	4.74
933154	3/8"	6.42
933155	1/4" x 1/8"	4.60
933156	3/8" x 1/4"	4.89

### Stem Adapters



Part #	Stem OD x NPTF	Price
933033	1/4"	0.73
933035	3/8"	1.13
933036	1/2"	1.86
933038	1/4" x 1/8"	0.73
933034	3/8" x 1/4"	0.89
933032	1/2" x 3/8"	1.86

### Stem Reducers



Part #	Stem OD x Tube OD	Price
933039	3/8" x 1/4"	2.30
933040	1/2" x 3/8"	4.39
933041	5/8" x 1/4"	4.31
933042	5/8" x 3/8"	4.47
933043	5/8" x 1/2"	4.57

### Plugs



Part #	Stem OD	Price
933045	1/4"	0.58
933046	5/16"	0.69
933048	3/8"	0.96
933047	1/2"	1.49

### Tube to Hose Stems (Hose Barb)



Part #	Stem OD x Hose ID	Price
933142	1/2"	2.80
933126	3/8"	2.09
933129	3/8" x 1/2"	2.83
933131	1/2" x 3/8"	2.26

### Tube Inserts



Part #	ID	OD	Price
933185	1/4"	5/16"	0.19
933186	5/16"	3/8"	0.25
933187	3/8"	1/2"	0.25

### Angle Stop Adapter Valves

- Connects between your valve and riser to the main water supply line for applications in Reverse Osmosis, Filtration Systems, Automatic Coffee Brewers, Ice-makers, and many more.
- For use with water supply only



Part #	Size	Price
933162	3/8" x 3/8" x 3/8"	13.33

Prices & specifications are subject to change.

Our office hours are 7am to 4:30pm and counter hours 6am to 4:30pm Monday through Friday.



# Twist & Lock Fittings



## Polyethylene Fittings (Continued)

### Angle Stop Adapter Valves

Part #	Size	Price
933161	3/8" x 3/8" x 1/4"	12.85

### Shutoff Ball Valves

- The valves are for use with potable water.
- The valves are not to be used with compressed air, explosive gases, petroleum spirits and other fuels or for heating systems.



Part #	Size	Price
933175	1/4"	6.72
933174	3/8"	7.10

### Polyethylene Tubing

- Produced in linear low density Polyethylene for cold and intermittent hot water applications.
- FDA compliant materials
- NSF International standard 51 & 61 certified
- Natural color



Part #	Size	Price
933177	1/4" x 500'	0.19
933179	5/16" x 500'	0.33
933180	3/8" x 500'	0.42
933182	1/2" x 250'	0.60

## How to make a Standard Connection

### MAKING A GOOD CONNECTION:

To make a connection, the tube is simply pushed in by hand; the unique patented John Guest collet locking system then holds the tube firmly in place without deforming it or restricting flow.

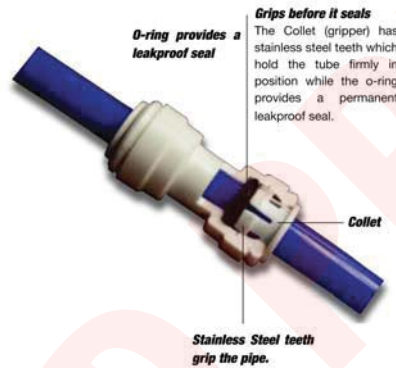

#### CUT THE TUBE SQUARE



Cut the tube square and remove burrs and sharp edges. Ensure that the outside diameter is free from score marks. For soft or thin-walled plastic tubing we recommend the use of a tube insert.

#### PUSH UP TO TUBE STOP



Push the tube into the fitting and up to the tube stop.

#### PULL TO CHECK SECURE



Pull on the tube to check that it is secure. Test the system before use.

#### TO DISCONNECT Push in collet and remove tube



To disconnect, ensure that the system is depressurized, push the collet square against the fitting. With the collet held in this position the tube can be removed.

### MATERIALS OF CONSTRUCTION

**John Guest Fittings** are made up of three components:

**Bodies** are produced in acetal copolymer or polypropylene.

**O-rings** are produced in Nitrile or EPDM.

**Collets** are produced in acetal copolymer or polypropylene with stainless steel teeth.





## Vinyl Tubing

Radiator Specialty Company

### Vinyl Tubing Clear



- Non-toxic formula
- Clear, soft, flexible & durable

Part #	Mfg #	ID	OD	Coil	Price
16670	DV-308	1/8"	1/4"	100'	14.16
16674	DV-310	1/4"	3/8"	100'	20.21
16680	DV-311	3/8"	1/2"	100'	27.01
16684	DV-3125	1/2"	5/8"	100'	35.36
16688	DV-313	5/8"	7/8"	50'	42.62
16690	DV-314	3/4"	1"	30'	46.90
16692	DV-315	1"	1-1/4"	30'	61.36
16694	DV-316	1-1/4"	1-5/8"	50'	161.25
16696	DV-317	1-1/2"	2"	50'	298.54

### Polyethylene Pressure Tubing

Part #	Mfg #	ID	OD	Coil	Price
16700	DP-308	1/8"	1/4"	100'	10.55
16704	DP-310	1/4"	3/8"	100'	20.27
16706	DP-311	3/8"	1/2"	100'	33.28



### Nylon Fittings

#### Nylon Insert x Male Adapters



Part #	Mfg #	Size	Price
8711	I11-001	1/2"	1.27
8712	I11-002	3/4"	1.24
8713	I11-003	1"	1.56
8714	I11-004	1-1/4"	3.32
8715	I11-005	1-1/2"	3.25
8716	I11-006	2"	6.15

#### Nylon Insert 90-Degree Elbows



Part #	Mfg #	Size	Price
8717	I11-013	1/2"	2.28
8718	I11-014	3/4"	3.00
8719	I11-015	1"	3.22

Prices & specifications are subject to change.

You can check stock availability, pricing and place orders online at [www.MetPipe.com](http://www.MetPipe.com).

### Nylon Fittings (Continued)

#### Nylon Insert 90-Degree Elbows

Part #	Mfg #	Size	Price
8720	I11-016	1-1/4"	5.54
8721	I11-017	1-1/2"	8.13
8722	I11-018	2"	13.55

#### Nylon Insert Tees



Part #	Mfg #	Size	Price
8723	I11-019	1/2"	2.95
8724	I11-020	3/4"	3.19
8725	I11-021	1"	3.84
8726	I11-022	1-1/4"	9.36
8727	I11-023	1-1/2"	12.55

#### Nylon Insert Couplings



Part #	Mfg #	Size	Price
8705	I11-007	1/2"	1.27
8706	I11-008	3/4"	1.12
8707	I11-009	1"	1.44
8708	I11-010	1-1/4"	2.67
8709	I11-011	1-1/2"	6.12
8710	I11-012	2"	6.98

#### Nylon Hose Barb Spicer (Barb x Barb)



Part #	Mfg #	Size	Price
16709	N10-004	3/8" x 3/8"	0.75

#### Nylon Hose Barb Adapter (MPT x Barb)



Part #	Mfg #	Size	Price
40282	N14-001	1/4" x 1/4"	0.67
16711	N14-004	3/8" x 3/8"	0.72



# Garden Hose, Fittings & Accessories

## Brass Hose Fittings

### Brass Adapters (MHT x MIP)



Part #	Mfg #	Size	Price
16813	G20-003	3/4" MHT x 3/4" MIP (1/2" FIP Tap)	3.31
16812	G20-004	3/4" MHT x 1/2" MIP (1/2" Sweat)	3.51

### Brass Adapters (MHT x MHT)



Part #	Mfg #	Size	Price
16814	G20-008	3/4" MHT x 3/4" MHT (1/2" FIP Tap)	3.52

### Brass Adapters (MHT x FIP)



Part #	Mfg #	Size	Price
16809	G20-010	3/4" MHT x 1/2" FIP	2.85
16810	G20-011	3/4" MHT x 3/4" FIP	3.97

### Brass Adapters (FHT x MIP)



Part #	Mfg #	Size	Price
16811	G20-016	3/4" FHT x 3/4" MIP (1/2" FIP Tap)	3.97

### Brass Adapters (FHT x FIP)



Part #	Mfg #	Size	Price
16807	G20-020	3/4" FHT x 1/2" FIP	3.74
16808	G20-021	3/4" FHT x 3/4" FIP	4.56

### Brass Swivel Adapter (Swivel FHT x FHT)



Part #	Mfg #	Size	Price
16806	G20-030	3/4" FHT x 3/4" FHT	4.14

### Brass Swivel Adapter (Swivel FHT x FIP)



Part #	Mfg #	Size	Price
16804	G20-031	3/4" FHT x 1/2" FIP	3.71
16805	G20-032	3/4" FHT x 3/4" FIP	4.65

### Brass Hose Wye (FHT x MHT)



Part #	Mfg #	Size	Price
16823	G20-050	3/4" FHT x 3/4" MHT	8.74

### Brass Garden Hose Cap (FHT)



Part #	Mfg #	Size	Price
40785	G20-055	3/4" FHT	2.23

### Brass Hose Barbs Hose Barb to Male Pipe



• Barb refers to hose ID

Part #	Mfg #	Size	Price
215564	G25-022	1/8" Barb x 1/8" MPT	1.26
16826	G25-042	1/4" Barb x 1/8" MPT	4.65
16828	G25-044	1/4" Barb x 1/4" MPT	1.04
16827	G25-062	3/8" Barb x 1/8" MPT	0.96
16829	G25-064	3/8" Barb x 1/4" MPT	1.07
55505	G25-068	3/8" Barb x 1/2" MPT	3.33
200735	G25-121	3/4" Barb x 3/4" MIP	5.69
192097	G25-169	1" Barb x 1" MIP	13.27

### Hose Barb to Female Pipe

Part #	Mfg #	Size	Price
16835	G26-044	1/4" Barb x 1/4" FPT	2.19
182819	G26-046	1/4" Barb x 3/8" FPT	1.74
16836	G26-064	3/8" Barb x 1/4" FPT	3.49
114411	G26-066	3/8" Barb x 3/8" FPT	6.73
182820	G26-068	3/8" Barb x 1/2" FPT	3.33
16837	G26-084	1/2" Barb x 1/4" FPT	2.03
182821	G26-086	1/2" Barb x 3/8" FPT	1.67
114413	G26-088	1/2" Barb x 1/2" FPT	9.15

Pipe, Fittings, Hardware



# Handrail Fittings

## Flanges

- Slip on
- Cast ASTM B26
- Astm B179 535 Aluminum/Magnesium Alloy Material
- Bright burnished mill finish

### Triangular Flange

- Bolts not included.
- 3 bolt holes



Part #	Mfg#	Model #	Size	Bolt Size	Price
8769	25010	40	3/4"	5/16"	7.49
8799	26010	40	1"	5/16"	9.69
8831	27020	40	1-1/4"	7/16"	10.50
8867	28020	40	1-1/2"	7/16"	12.44

### Adjustable Wall Flange

- For use on wall only. Cannot be used as a floor flange.
- Bolts not included.
- 3 bolt holes



Part #	Mfg#	Model #	Size	Bolt Size	Price
8770	25040	41	3/4"	5/16"	16.98
8800	26040	41	1"	5/16"	15.16
8832	27050	41	1-1/4"	7/16"	16.88
8868	28050	41	1-1/2"	7/16"	18.48

### Round Base Flange

- Bolts not included.
- 4 bolt holes



Part #	Mfg#	Model #	Size	Bolt Size	Price
917092	25080	42	3/4"	3/16"	Call
934421	26080	42	1"	1/4"	11.74
8833	27090	42	1-1/4"	7/16"	12.42
8869	28090	42	1-1/2"	7/16"	14.44

### Round Wall Flange

- For use on wall only. Cannot be used as a floor flange.
- No bolt holes.



Part #	Mfg#	Model #	Size	Price
8771	25100	43	3/4"	8.57
8801	26100	43	1"	11.74
8834	27100	43	1-1/4"	13.68
8870	28100	43	1-1/2"	15.34

## Square Floor Flange

- Bolts not included.
- 4 bolt holes.



Part #	Mfg#	Model #	Size	Bolt Size	Price
8772	25120	45	3/4"	5/16"	8.24
8802	26120	45	1"	5/16"	10.07
8835	27130	45	1-1/4"	7/16"	11.56
8871	28130	45	1-1/2"	7/16"	14.11

## Thin Base Flange

- Bolts not included.
- Not recommended for use on handrail.
- 2 bolt holes.



Part #	Mfg#	Model #	Size	Bolt Size	Price
53699	27140	46	1-1/4"	7/16"	14.53
43653	28140	46	1-1/2"	7/16"	15.75

## Adjustable Thin Base Flange

- Bolts not included.
- Not recommended for use on handrail.
- Adjustable
- 2 bolt holes.



Part #	Mfg#	Model #	Size	Bolt Size	Price
884594	27150	46ADJ	1-1/4"	7/16"	42.03
8872	28150	46ADJ	1-1/2"	7/16"	42.03

## Rectangular Base Flange

- Bolts not included.
- 4 bolt holes.



Part #	Mfg#	Model #	Size	Bolt Size	Price
8773	25160	47	3/4"	5/16"	8.34
8803	26160	47	1"	5/16"	9.85
8836	27170	47	1-1/4"	7/16"	11.98
8873	28170	47	1-1/2"	7/16"	14.11
8889	29170	47	2"	7/16"	21.43

## Wall Mount Triangular Flange

- Bolts not included.
- 3 bolt holes.



Part #	Mfg#	Model #	Size	Bolt Size	Price
8774	25270	50	3/4"	5/16"	9.93
8804	26270	50	1"	5/16"	17.92

Prices & specifications are subject to change.

We offer a variety of GREEN products such as flush valves, faucets, showerheads & more!



## Handrail Fittings

### Flanges (Continued)

#### Wall Mount Triangular Flange

Part #	Mfg#	Model #	Size	Bolt Size	Price
8837	27280	50	1-1/4"	7/16"	13.54
8874	28280	50	1-1/2"	7/16"	18.54

#### Wall Mount Support Bracket

- Bolts not included.
- 2 bolt holes.
- Offset



Part #	Mfg#	Model #	Size	Bolt Size	Price
38324	27360	50	1-1/4"	7/16"	15.12
212666	28360	50	1-1/2"	7/16"	16.05

### Tees

- Slip on
- Cast ASTM B26
- Astm B179 535 Aluminum/Magnesium Alloy Material
- Bright burnished mill finish

#### Tee



Part #	Mfg#	Model #	Size	Price
8754	05040	5	3/4"	9.17
8780	06040	5	1"	11.04
8812	07040	5	1-1/4"	13.37
8848	08040	5	1-1/2"	17.13
8880	09040	5	2"	26.98

#### Thin Tee

- Outlets of the tee are flush with the body.



Part #	Mfg#	Model #	Size	Price
884740	05060	5E	3/4"	Call
33634	06060	5E	1"	7.09
8813	07060	5E	1-1/4"	8.85
143297	08060	5E	1-1/2"	11.36

### Side Outlet Tee / Elbow

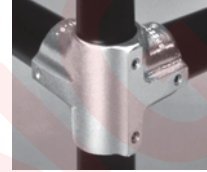

Part #	Mfg#	Model #	Size	Price
8758	01540	11	3/4"	12.56
8784	06140	11	1"	13.71
8817	07140	11	1-1/4"	17.03
8852	08140	11	1-1/2"	19.84
123934	09140	11	2"	32.37

### Thin Side Outlet Tee

- Outlets of the tee are flush with the body.

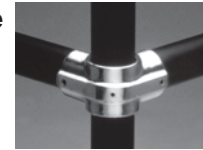

Part #	Mfg#	Model #	Size	Price
33636	06150	11E	1"	9.54
33640	07150	11E	1-1/4"	11.52
115814	08150	11E	1-1/2"	13.31

### Offset Tee



Part #	Mfg#	Model #	Size	Price
41401	07210	15	1-1/4"	24.15

### Adjustable Tee



Part #	Mfg#	Model #	Size	Price
8760	05230	17	3/4"	13.77
8787	06230	17	1"	16.40
8820	07230	17	1-1/4"	17.06
8855	08230	17	1-1/2"	18.66
56922	09230	17	2"	38.87



# Handrail Fittings

## Elbows

- Slip On
- Cast ASTM B26
- Astm B179 535 Aluminum/Magnesium Alloy Material
- Bright Burnished Mill Finish

### Elbow



Part #	Mfg#	Model #	Size	Price
8753	05020	3	3/4"	8.54
8779	06020	3	1"	9.30
8810	07020	3	1-1/4"	11.36
8847	08020	3	1-1/2"	14.72
8879	09020	3	2"	21.48

### Adjustable Elbow



Part #	Mfg#	Model #	Size	Price
8811	07030	3AE	1-1/4"	22.18
198182	08030	3AE	1-1/2"	27.20

### Side Outlet Elbow

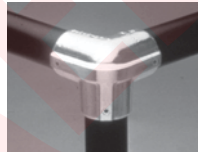

Part #	Mfg#	Model #	Size	Price
8756	05120	9	3/4"	11.61
8782	06120	9	1"	12.23
8815	07120	9	1-1/4"	16.01
8850	08120	9	1-1/2"	15.86
8882	09120	9	2"	32.04

### Outside Corner



Part #	Mfg#	Model #	Size	Price
8789	06350	20	1"	21.36
8822	07350	20	1-1/4"	25.47
8857	08350	20	1-1/2"	30.67

## Side Outlet Adjustable Elbow

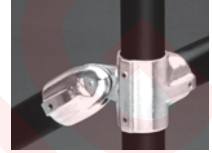

Part #	Mfg#	Model #	Size	Price
8764	05420	25	3/4"	18.11
8793	06420	25	1"	19.79
8826	07420	25	1-1/4"	23.02
8861	08420	25	1-1/2"	26.68

## Double Adjustable Side Outlet Elbow

- Adjustable outlets are 90°. For straight outlets, see #19 cross.



Part #	Mfg#	Model #	Size	Price
8765	05440	27	3/4"	25.90
8794	06440	27	1"	27.06
8827	07440	27	1-1/4"	32.08
8862	08440	27	1-1/2"	31.45

## Wall Return Elbows

- Left and right sided orientation available.



Part #	Mfg#	Model #	Size	Price
8843	07920	84AL	1-1/4"	14.88
8844	07930	84AR	1-1/4"	14.88

## Wall Return Elbows



#82



#82A

- Offset, centerline from wall:  
 #82 4-1/8"  
 #82A 3"

Part #	Mfg#	Model #	Size	Price
33643	07875	82	1-1/4" & 1-1/2"	14.75
8842	07885	82A	1-1/4" & 1-1/2"	14.66

Prices & specifications are subject to change.

Our state of the art pipe shop offers cutting, threading, grooving and make-ons up to 36in!



## Handrail Fittings

### Crosses

- Slip On
- Cast ASTM B26
- Astm B179 535 Aluminum/Magnesium Alloy Material
- Bright Burnished Mill Finish

#### Cross

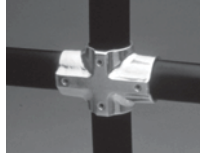

Part #	Mfg#	Model #	Size	Price
8755	05090	7	3/4"	12.43
8781	06090	7	1"	14.67
8814	07090	7	1-1/4"	17.15
8849	08090	7	1-1/2"	21.00
8881	09090	7	2"	25.66

#### Thin Cross

- Outlets of one side of the cross are flush with the other set of outlets.



Part #	Mfg#	Model #	Size	Price
33635	06100	7E	1"	10.25
33639	07100	7E	1-1/4"	12.60
36722	08100	7E	1-1/2"	13.63

### Offset Crosses



Part #	Mfg#	Model #	Size	Price
8757	05130	10	3/4"	14.46
8783	06130	10	1"	18.83
883467	01130	10	1" x 1-1/4"	17.41
8816	07130	10	1-1/4"	19.54
887432	02130	10	1-1/4" x 1-1/2"	19.57
8851	08130	10	1-1/2"	21.58
887434	03130	10	1-1/2" x 2"	21.58
195854	09130	10	2"	34.45

### Side Outlet Cross



Part #	Mfg#	Model #	Size	Price
8759	05170	13	3/4"	15.01
8785	06170	13	1"	17.13
8818	07170	13	1-1/4"	20.11

### Crosses (Continued)

#### Side Outlet Cross

Part #	Mfg#	Model #	Size	Price
8853	08170	13	1-1/2"	24.22

#### Modular Offset Cross Assembly

- Includes both pieces pictured.

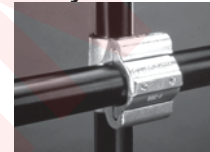

Part #	Mfg#	Model #	Size	Price
8786	16040	14S	1"	23.62
8819	17040	14S	1-1/4"	24.60
8854	08040	14S	1-1/2"	30.31

#### Adjustable Cross



Part #	Mfg#	Model #	Size	Price
8761	05330	19	3/4"	20.10
8788	06330	19	1"	9.93
8821	07330	19	1-1/4"	31.27
8856	08330	19	1-1/2"	33.22

#### Adjustable Tee/Cross



Part #	Mfg#	Model #	Size	Price
8763	05400	23	3/4"	18.11
8792	06400	23	1"	19.79
8825	07400	23	1-1/4"	23.02
8860	08400	23	1-1/2"	26.37

#### Adjustable Offset Crosses

- 2-piece
- Composed of #30A & 30C available seperately



Part #	Mfg#	Model #	Size	Price
8766	05500	30	3/4"	25.82
8795	06500	30	1"	28.41
8828	07500	30	1-1/4"	35.27
8863	08500	30	1-1/2"	39.08



## Handrail Fittings

### Modified Cross

- One side of one outlet is flush with the body of the opposite side.
- For use with 30B swivel



Part #	Mfg#	Model #	Size	Price
45345	05510	30A	3/4"	13.27
8796	06510	30A	1"	15.70
33642	07510	30A	1-1/4"	18.90
8864	08510	30A	1-1/2"	20.63

### Couplings

- Slip On
- Cast ASTM B26
- Astm B179 535 Aluminum/Magnesium Alloy Material
- Bright Burnished Mill Finish

#### External Coupling

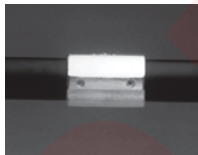

Part #	Mfg#	Model #	Size	Price
8777	05630	70	3/4"	7.28
8807	06630	70	1"	8.56
8841	07630	70	1-1/4"	9.75
8878	08630	70	1-1/2"	12.30
8892	09630	70	2"	19.10

### Swivels

#### Swivel



Part #	Mfg#	Model #	Size	Price
8767	05520	30B	3/4"	12.60
8797	06520	30B	1"	13.00
8829	07520	30B	1-1/4"	17.41
8865	08520	30B	1-1/2"	19.39

#### Adjustable Swivel

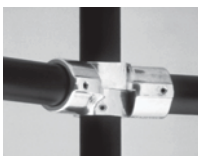

Part #	Mfg#	Model #	Size	Price
8768	05530	30C	3/4"	17.98
8798	06530	30C	1"	23.39

### Swivels (Continued)

#### Adjustable Swivel

Part #	Mfg#	Model #	Size	Price
8830	07530	30C	1-1/4"	27.41
8866	08530	30C	1-1/2"	27.79

### Plugs Pipe Plug

- Sch. 40
- Designed to cover pipe wall only.



Part #	Mfg#	Model #	Size	Price
8775	05600	60	3/4"	2.70
8805	06600	60	1"	3.69
8839	07600	60	1-1/4"	3.99
8876	08600	60	1-1/2"	4.76
8890	09600	60	2"	6.32

#### Fitting Plug

- Sch. 40
- Designed to cover pipe wall and fitting wall.



Part #	Mfg#	Model #	Size	Price
8776	05610	62	3/4"	2.58
8806	06610	62	1"	3.69
8840	07610	62	1-1/4"	3.99
8877	08610	62	1-1/2"	4.12

### Rackmaster Racking Systems

- Slip On
- Cast ASTM B26
- Astm B179 535 Aluminum/Magnesium Alloy Material
- Bright Burnished Mill Finish



Part #	Mfg#	Model #	Size	Price
8808	06730	100	1"	27.07
8845	07730	100	1-1/4"	31.00
202594	08730	100	1-1/2"	32.85

Prices & specifications are subject to change.

Metropolitan Pipe offers FREE DELIVERY in the Greater Boston area.



## Gaskets

### Non-Asbestos Gaskets

#### Non-Asbestos 150# Ring Gaskets



Part #	Size	Price
35411	3/4"	0.68
8148	1"	0.80
8149	1-1/4"	1.04
8150	1-1/2"	1.20
8151	2"	1.48
8152	2-1/2"	1.76
8153	3"	2.00
8154	3-1/2"	3.92
8155	4"	3.44
8156	5"	4.04
8157	6"	5.24
8158	8"	6.24
8159	10"	8.80
8160	12"	13.76
42991	14"	18.16
39668	16"	24.12
43201	18"	25.28
42068	20"	26.84
43204	24"	53.44

#### Non-Asbestos XH 300# Ring Gaskets

Part #	Size	Price
8161	1"	0.96
8162	1-1/4"	1.12
8163	1-1/2"	1.48
8164	2"	1.76
8165	2-1/2"	2.36
8166	3"	2.96
8168	4"	3.84
8169	5"	6.40
8170	6"	6.72
8171	8"	7.20
8172	10"	11.60

### Non-Asbestos 150# Full Face Gaskets



Part #	Size	Price
8175	3/4"	1.56
8176	1"	1.72
8177	1-1/4"	1.92
8178	1-1/2"	2.28
8179	2"	2.84
8180	2-1/2"	3.68
8181	3"	4.48
8182	4"	5.76
8183	5"	7.92
8184	6"	9.16
8185	8"	13.72
8186	12"	18.76

### Non-Asbestos XH 300# Full Face Gaskets

Part #	Size	Price
40128	2"	3.60
8194	2-1/2"	4.24
8195	3"	4.80
8196	4"	7.92
8197	5"	8.00
8198	6"	8.40
8199	8"	14.64

### Red Rubber Gaskets

#### Rubber 150# Ring Gaskets

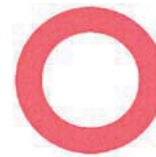

Part #	Size	Price
146643	1-1/2"	1.16
8187	2"	1.52
8188	2-1/2"	1.84
8189	3"	2.08
8190	4"	2.76
8191	5"	3.44
8192	6"	3.92
8193	8"	6.88





## Gaskets

### Rubber 150# Full Face Gaskets



Part #	Size	Price
8200	1/2"	1.04
8201	3/4"	1.16
8202	1"	1.32
8203	1-1/4"	1.52
8204	1-1/2"	1.96
8205	2"	2.24
8206	2-1/2"	2.64
8207	3"	2.92
8208	4"	4.40
8209	5"	5.40
8210	6"	6.64
8211	8"	8.40
117584	10"	12.04

### Red Rainbow Packing

Part #	Size	Price
8229	Pound - 1/8"	3.05
908571	12" x 12" Square	3.57

### 5' x 5' Non-asbestos Sheet Gasket Material

- 1/16in Thick

Part #	Size	Price
46625	5' x 5'	231.32

### Flexitallic Spiral Wound Gaskets

#### Type 304 SS



#### 150# Spiral Wound Gaskets

Part #	Size	Price
35412	3/4"	4.20
35413	1"	4.32
35414	1-1/4"	5.10
35415	1-1/2"	5.64
8212	2"	5.88
8213	2-1/2"	6.39

### Flexitallic Spiral Wound Gaskets (Continued)

#### 150# Spiral Wound Gaskets

Part #	Size	Price
8214	3"	6.87
8215	4"	8.40
8216	5"	9.18
8217	6"	11.55
8218	8"	14.07
8219	10"	20.01

#### 300# Spiral Wound Gaskets

Part #	Size	Price
8222	4"	8.88
8223	5"	10.32
8224	6"	13.08
8225	8"	16.17
8226	10"	23.64

#### 300-600# Spiral Wound Gaskets

Part #	Size	Price
35939	1"	4.74
37711	1-1/4"	5.19
37376	1-1/2"	5.40
35416	2"	5.67
8220	2-1/2"	6.03
8221	3"	7.53

#### 600# Spiral Wound Gaskets

Part #	Size	Price
35420	4"	17.07
8227	6"	15.60

Prices & specifications are subject to change.

Metropolitan Pipe offers Vendor Managed Inventory - never run out of that part again!



## Pipe Insulation

### Rubber Copper Tubing Insulation

- Sold in 6' lengths



#### 1/2" Wall

Part #	Mfg #	Size	Price
15563	6RX048068	1/2" ID	0.86
15564	6RX048058	5/8" ID	1.48
15566	6RX048078	7/8" ID	1.81
15568	6RX048118	1-1/8" ID	2.02
15570	6RX048138	1-3/8" ID	2.30
15572	6RX048158	1-5/8" ID	2.53
15574	6RX048218	2-1/8" ID	3.06

### Rubber Split Copper Pipe Insulation

- Sold in 6' lengths



#### 1/2" Wall

Part #	Mfg #	Size	Price
15565	6SRX048058	5/8" ID	0.76
15567	6SRX048078	7/8" ID	0.85
15569	6SRX048118	1-1/8" ID	0.98
15571	6SRX048138	1-3/8" ID	1.09
15573	6SRX048158	1-5/8" ID	1.29
34032	6SRX048218	2-1/8" ID	1.68

### Fiberglass Copper Pipe Insulation

- Sold in 3' lengths



#### 1/2" Wall

Part #	Mfg #	ID	Copper	Zeston	Price
15576	3FGX048058	5/8"	1/2"	3	1.48
15577	3FGX048048	1/2"	7/8"	3	1.48
15578	3FGX048068	3/4"	1-1/8"	4	1.68
15579	3FGX048088	1"	1-3/8"	5	1.74
15580	3FGX048108	1-1/4"	1-5/8"	7	1.84
15581	3FGX048128	1-1/2"	-	7	2.13
15582	3FGX048168	2"	-	9	2.27
44131	3FGX048178	2-1/8"	-	8	2.27

#### 1" Wall

Part #	Mfg #	ID	Copper	Zeston	Price
15585	3FGX088058	5/8"	3/8"	3	1.80
15586	3FGX088048	1/2"	7/8"	3	1.80
15587	3FGX088068	3/4"	1-1/8"	4	1.96
15588	3FGX088088	1"	1-3/8"	5	2.10
15589	3FGX088108	1-1/4"	1-5/8"	7	2.27
15590	3FGX088128	1-1/2"	-	10	2.45
15592	3FGX088168	2"	-	11	2.65
15591	3FGX088178	2-1/8"	-	10	2.65
37478	3FGX088208	2-1/2"	-	12	3.01
15593	3FGX088248	3"	-	13	3.23
15594	3FGX088328	4"	-	15	4.28

### Pipe Insulation Tape

Part #	Mfg #	Description	Price
15596		2" x 30' Roll, 1/8"	21.24
15598		3" x 150' ASJ Tape	32.08



**Johns Manville**

### Zeston® 2000 PVC Insulated Fitting Covers and Jacketing

- Fitting covers and jacketing together form a completely sealed system which meets USDA & FDA requirements for food, beverage and pharmaceutical facilities
- Insulate and protect pipe fittings
- Supplied with HiLo® Temp formaldehyde-free fiberglass insulation
- For indoor or outdoor use on chilled water, hot water, steam and other piping systems

### Zeston® 2000 45° Elbow Insulation (Iron Pipe Sizes)

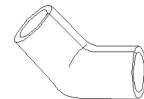

Part #	Size	1/2" Ins Pipe	1" Ins Pipe	Price
41690	#3	1/2"	-	0.96
41691	#5	1"	-	1.18
36359	#7	1-1/2"	3/8 - 3/4"	1.35
36364	#9	2"	1 - 1-1/4"	1.71
41695	#10	2-1/2"	1-1/2"	2.16
36371	#11	3"	2"	2.61
46602	#15	5"	3-1/2 - 4"	7.03



## Vendor Managed Inventory Program

Metropolitan Pipe can assist you in setting up your own *stockroom*- complete with barcodes for easy tracking.



Product ID: 454645

Kohler 4330-0 Kingston elongated wall-hung bowl with top spud



Aisle 7 - Shelf B

### Zeston® 2000 90° Elbow Insulation (Iron Pipe Sizes)

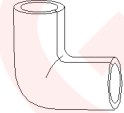

Part #	Size	1/2" Ins Pipe	1" Ins Pipe	Price
43448	#3	1/2"	-	0.96
41684	#5	1"	-	1.18
36356	#7	1-1/2"	3/8 - 3/4"	1.35
36363	#9	2"	1 - 1-1/4"	1.71
38251	#10	2-1/2"	1-1/2"	2.16
38400	#11	3"	2"	2.61
36373	#12	3-1/2"	2-1/2"	3.04
44033	#13	4"	3"	4.01
42692	#15	5"	3-1/2 - 4"	7.03

### Zeston® 2000 Tee Insulation (Iron Pipe Sizes)

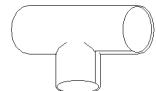

Part #	Size	1/2" Ins Pipe	1" Ins Pipe	Price
43446	#3	1/2"	-	1.66
39472	#5	1"	-	1.96
36360	#7	1-1/2"	3/8 - 3/4"	2.34
36365	#9	2"	1 - 1-1/4"	3.06
36369	#10	2-1/2"	1-1/2"	3.62
36372	#11	3"	2"	4.50
36374	#12	3-1/2"	2-1/2"	5.41
41352	#13	4"	3"	7.19
41351	#15	5"	3-1/2 - 4"	11.68

### Z-Tacks

- White powder coated stainless steel with serrated ribs
- For installing PVC fittings

Part #	Description	Price
37749	Box of 500	25.51



## Heating Cable



### Frostex® Heating Cable

#### Frostex 2102 100' Pipe Heating Spool Cable

- Frostex 100' Pipe Heating Spool Cable is a self regulating heating core that monitors its own temperature automatically with out an external thermostat. Features dependable design, easy installation and no waste circuit protection.
- Dependable design
- Easy installation
- No waste
- Circuit protection



Part #	Mfg #	Description	Price
906666	2102	100ft Spool	322.00

#### Frostex FlexFit® Plug

- Use with braided Frostex heating cable
- The Frostex 9800 FlexFit kit provides the specially designed plug you need to plug one Frostex heating cable into an electrical outlet. The built-in power cord eliminates the need for extra heating cable from the pipe to the outlet.
- CSA and FM approved and UL listed.



Part #	Mfg #	Description	Price
17071	9800	Built-In 30' Power Cord	20.28

#### FrostEx Starter Kit

- Includes:  
 (2) #9800 FlexFit Plugs  
 50ft Spool of Pipe Heating Cable



Part #	Mfg #	Description	Price
908477	5050	Includes: 50ft spool of Frostex Heat Cable (2) 9800 plug kits.	228.16

## Electronic Billing

Save time and get your invoices faster online, by email or fax!

Sign up today:  
<http://ebilling.metpipe.com>

Pipe, Fittings, Hardware



# Hardware

## Screws, Nuts & Bolts



### Nuts Hex Nuts



Part #	Size	Price
8629	1/4" Heavy	0.08
8630	3/8" Heavy	0.11
8631	1/2" Heavy	0.23
8632	5/8" Heavy	0.42
8633	3/4" Heavy	0.57
8634	7/8" Heavy	0.83
39674	1" Heavy	0.98

### Bolts Machine Bolts

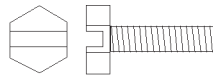

Part #	Size	Price
8599	3/8" x 1"	0.87
156137	3/8" x 1-1/2"	0.26
8600	1/2" x 1-1/2"	0.44
8601	1/2" x 2"	0.42
38876	1/2" x 2-1/4"	1.00
8602	1/2" x 2-1/2"	0.47
8603	5/8" x 1-1/2"	0.63
8604	5/8" x 1-3/4"	0.66
8605	5/8" x 2"	0.69
8606	5/8" x 2-1/4"	0.88
8607	5/8" x 2-1/2"	0.64
8608	5/8" x 2-3/4"	0.98
8609	5/8" x 3"	1.03
8610	5/8" x 3-1/2"	1.14
8611	5/8" x 4"	1.28
8612	5/8" x 5"	1.60
8613	3/4" x 1-3/4"	1.09
8614	3/4" x 2"	0.86
8615	3/4" x 2-1/4"	1.31
8616	3/4" x 2-3/4"	1.50
8617	3/4" x 3"	1.59
8618	3/4" x 3-1/4"	1.70
8619	3/4" x 3-1/2"	1.75
8620	3/4" x 3-3/4"	1.77
8621	3/4" x 4"	1.50
8622	3/4" x 5"	1.74
8623	3/4" x 5-1/2"	2.30
8624	7/8" x 2-1/4"	1.56
8625	7/8" x 2-1/2"	1.62
167427	7/8" x 3-1/2"	1.40
8626	7/8" x 3-3/4"	2.65

### Bolts (Continued) Machine Bolts

Part #	Size	Price
8627	7/8" x 4"	3.02
8628	7/8" x 4-1/2"	3.23
157872	7/8" x 5"	3.44
187107	1" x 2-3/4"	1.58

### Zinc-Plated Bolt

Part #	Size	Price
39988	5/8" x 2-1/2"	0.61

### Washers Flat Washers

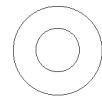

• Low carbon steel

Part #	Size	Finish	Price
8635	1/8"	Plain	0.05
8637	1/4"	Plain	0.04
8639	3/8"	Plain	0.08
8641	1/2"	Plain	0.13
8643	5/8"	Plain	0.23
8645	3/4"	Plain	0.37
8648	7/8"	Plain	0.75

### All Threaded Rods Black Threaded Rod



Part #	Size	Price
8502	1/4" x 6'	2.76
8503	3/8" x 6'	3.36
8504	1/2" x 6'	6.00
8505	5/8" x 6'	11.04
8506	3/4" x 6'	15.36

### CAD Threaded Rod

Part #	Size	Price
8509	3/8" x 6'	4.08
8510	1/2" x 6'	8.04
48317	5/8" x 6'	12.96
8511	3/4" x 6'	19.56

Prices & specifications are subject to change.

Our office hours are 7am to 4:30pm and counter hours 6am to 4:30pm Monday through Friday.



## Bolts, Nuts, Screws & Washers

### Bolts

#### Toggle Bolt with Wings

- Zinc-plated
- Spring loaded wing



Part #	Mfg #	Size	Price
38313	F33-060	3/16" x 4"	0.53
8515	F33-062	1/4" x 4"	0.61
8516	F33-064	3/8" x 4"	1.44

#### Wing Only

- Zinc-plated and spring loaded



Part #	Mfg #	Size	Price
8518	F33-068	3/8"	1.14



### "Jiffy" Point Screws

- 1/4" Indented hex washer head
- Slotted, hardened, undercut zinc plated sheet metal



Part #	Mfg #	Size	Pkg Qty	Price
142153	821-1	#7 x 1/2"	100	3.57
142156	823-1	#8 x 3/4"	100	4.89
142157	824-1	#8 x 1"	100	5.66
142158	825-1	#8 x 1-1/4"	100	6.12
142159	826-1	#8 x 1-1/2"	100	7.61
142160	827-1	#8 x 2"	100	11.50

### Anchor Kits

- (2) Compartment plastic box



#### Hex Washer Head Sheet Metal Screws

Part #	Mfg #	Size	Bit Dia	Pkg Qty	Price
142152	471	#10-1-1/4	1/4"	100	10.48

### Pipe Hangers



### Pipe Straps

#### Two-Hole Galvanized Pipe Strap (Figure 72)



Part #	Size	Price
8375	3/8"	0.10
8376	1/2"	0.41
8377	3/4"	0.44
8378	1"	0.47
8379	1-1/4"	0.76
8380	1-1/2"	0.84
8381	2"	1.30
47857	2-1/2"	1.68
8382	3"	2.70
47969	4"	5.15

### Perforated Strap

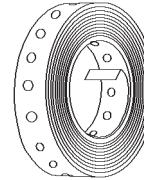

Part #	Description	Price
8512	10' Roll Copper	4.50
8513	10' Roll Iron	1.19

### Top Beam Clamps

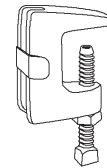

Part #	Description	Price
8372	3/8" Black	1.44
8373	1/2" Black	2.49
44667	5/8" Black	5.36
44668	3/4" Black	7.21
46777	3/8" Wide Mouth	2.59



## Pipe Fasteners



### C-Clamps - Black



Part #	Size	Price
8370	3/8"	2.00
8371	1/2"	2.03
50981	5/8"	2.90
57089	7/8"	1.99

### Side Beam Connector (Figure 153)

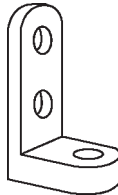

Part #	Size	Price
8438	3/8"	0.70
8439	1/2"	1.33

### Angle Fittings (Fig 152)

- Return line bracket

Part #	Size	Price
8444	2" x 3"	3.57
8445	3" x 4"	6.72

### Swivel Ring Hangers (800 C&P)



#### Galvanized Swivel Ring Hangers

Part #	Size	Price
8409	1/2"	0.49
8410	3/4"	0.53
8411	1"	0.56
8412	1-1/4"	0.63
8413	1-1/2"	0.70
8414	2"	0.81

### Swivel Ring Hangers (800 C&P) (Continued) Galvanized Swivel Ring Hangers

Part #	Size	Price
8415	2-1/2"	1.23
8416	3"	1.68
8418	4"	1.93

### F&M Split Ring Hangers (81CT)

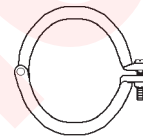

#### Copper Coated F&M Split Ring Hanger

Part #	Size	Price
8479	3/8"	4.03
8480	1/2"	0.88
8481	3/4"	0.98
8482	1"	1.12
8483	1-1/4"	1.33
8484	1-1/2"	1.68
8485	2"	2.21
8486	2-1/2"	5.88
8487	3"	7.84
123193	4"	8.26

#### Galvanized F&M Split Ring Hangers

Part #	Size	Price
8399	3/8"	0.77
8400	1/2"	0.77
8401	3/4"	0.88
8402	1"	1.12
8403	1-1/4"	1.37
8404	1-1/2"	1.58
8405	2"	2.03
8406	2-1/2"	3.54
8407	3"	4.90
8408	4"	6.20

Prices & specifications are subject to change.

You can check stock availability, pricing and place orders online at [www.MetPipe.com](http://www.MetPipe.com).



## Pipe Fasteners



### Riser Clamps (Friction Clamps) (Figure 126)

- Equal arms

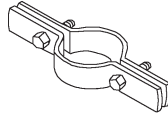

#### Black Riser Clamps

Part #	Size	Price
154614	1/2"	1.78
8385	3/4"	4.06
8386	1"	4.17
8387	1-1/4"	4.24
8388	1-1/2"	4.45
8389	2"	5.71
8390	2-1/2"	6.37
8391	3"	6.65
8392	3-1/2"	5.08
8393	4"	8.09
8394	5"	12.36
8395	6"	15.65
8396	8"	26.95
8397	10"	42.53
8398	12"	60.87

### Copper Riser Clamps (Figure 126)

- Copper plated carbon steel

Part #	Size	Price
8491	1/2"	3.33
8492	3/4"	3.54
8493	1"	4.76
8494	1-1/4"	5.15
8495	1-1/2"	5.50
8496	2"	5.92
8497	2-1/2"	6.90
8498	3"	7.53
8499	4"	9.80

### Clevis Hangers Copper Clevis Hangers



Part #	Size	Price
8470	1/2"	1.23
8471	3/4"	1.23
8472	1"	1.26
8473	1-1/4"	1.30
8474	1-1/2"	1.51
8475	2"	1.89
8476	2-1/2"	4.06
8477	3"	4.52
8478	4"	5.22

### Black Clevis Hangers



Part #	Size	Price
8355	1/2"	0.95
8356	3/4"	1.12
8357	1"	1.12
8358	1-1/4"	1.37
8359	1-1/2"	1.54
8360	2"	1.86
8361	2-1/2"	2.56
8362	3"	3.12
8363	3-1/2"	3.47
8364	4"	3.47
8365	5"	5.95
8366	6"	9.00
8367	8"	13.76
8368	10"	23.77
8369	12"	33.95

### 1A-Band Hangers



#### Copper 1A-Band Hangers

Part #	Size	Price
8461	1/2"	0.88





## Pipe Fasteners



### 1A-Band Hangers (Continued)

#### Copper 1A-Band Hangers

Part #	Size	Price
8462	3/4"	0.91
8463	1"	0.98
8464	1-1/4"	1.05
8465	1-1/2"	1.12
8466	2"	1.33
8467	2-1/2"	1.58
8468	3"	2.10
8469	4"	2.87
115055	6"	7.42

#### Black 1A-Band Hangers

Part #	Size	Price
8342	1/2"	0.63
8343	3/4"	0.63
8344	1"	0.81
8345	1-1/4"	0.91
8346	1-1/2"	0.98
8347	2"	1.26
8348	2-1/2"	2.03
8349	3"	2.17
8350	3-1/2"	2.49
8351	4"	2.91
8352	5"	3.43
8353	6"	5.85
8354	8"	9.63

### F&M Plates / Hanger Flange

- For attachment to wood beams or ceilings

#### Copper F&M Plates / Hanger Flanges



Part #	Size	Price
8488	3/8"	1.16
123195	1/2"	1.61

### Galvanized F&M Plates / Hanger Flanges



Part #	Size	Price
8436	3/8"	1.02
8437	1/2"	1.47

### Pipe Insulation Shields



Galvanized

Part #	Size	Price
51974	2" 2-3/8"	3.40
48016	2-1/2 2-7/8"	2.63
182194	3" 3-1/2"	3.33
52304	3-1/2" 4"	4.73
141817	4" 4-1/2"	4.73
226079	5" 5-5/8"	6.83
141818	6" 6-5/8"	6.65
808402	8" 8-5/8"	8.93

### Insert Nuts (Figure 650)



Part #	Size	Price
8440	3/8"	2.07
8441	1/2"	2.45
8443	3/4"	3.43

### Lag & Machine Rods (Figure 28)



Part #	Rod x Length	Price
8430	3/8" x 4"	1.37
8431	3/8" x 6"	1.58
8432	3/8" x 8"	1.75
8433	3/8" x 10"	2.00
8434	3/8" x 12"	2.80
44412	1/2" x 4"	3.19
8435	1/2" x 6"	2.80

Prices & specifications are subject to change.

We offer a variety of GREEN products such as flush valves, faucets, showerheads & more!



## Pipe Fasteners



### Drive Screws

Part #	Size	Price
8424	1-1/2"	0.39

### Fender Washers

- Low carbon steel
- Boxed



Part #	Size	Finish	Price
8458	1/4"	Plated	0.10
8459	3/8"	Plated	0.22
8460	1/2"	Plated	0.38

### Fish Plate

- Use wherever heavy duty washers are required

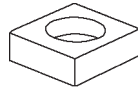

Part #	Size	Price
8446	3" x 3" - 1/2"	5.46

### Reznor Hooks



Part #	Size	Price
111081	1/2" x 10" IPS	0.62
111083	1" x 10" IPS	0.62
111084	1-1/4" x 10" IPS	0.86
111085	1-1/2" x 10" IPS	2.57
111087	1/2" x 10" Copper	0.76
111088	3/4" x 10" Copper	0.76
111089	1" x 10" Copper	0.76
111090	1-1/4" x 10" Copper	0.77
111092	2" x 10" Copper	3.17

### Van Hangers

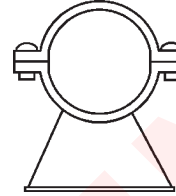

Part #	Size	Price
8546	1/2" Copper	0.88
8547	3/4" Copper	0.89
8548	1" Copper	0.95
91975	1-1/4" Copper	1.13
141207	1-1/2" Copper	1.54



### Pipe Clamps

#### Suspension Pipe Clamps

- Eliminates contact between the pipe and framing surface thereby reducing transmission of water line noise
- No corrosion - made of durable polypropylene (gray color)
- Ribbed design allows faster cooling and pipe expansion & contraction
- Can be used on hydronic systems



Part #	Mfg #	Size	Pkg Qty	Price
160308	33935	1/2"	100	22.22
160311	33936	3/4"	100	25.34
877209	33937	1"	50	45.00
877210	33956	1-1/4"	25	21.00
877211	33957	1-1/2"	25	29.50
877212	33958	2"	25	38.23

#### Standard Pipe Clamps

- Clamp design allows pipe to be flush mounted to walls & joists
- Minimizes the transmission of water line noise
- No corrosion - made of durable, polypropylene (gray color)
- Ribbed design allows pipe to cool faster & expand/contract freely



Part #	Mfg #	Size	Pkg Qty	Price
123019	33940	1/2"	100	22.45
160305	33941	3/4"	100	24.67
871400	33942	1"	100	50.00



## Pipe Hangers



### Copper-Plated Tubing Clips

- Copper-plated carbon steel
- Packaged with nails
- Snap onto tubing for hands-free nailing



Part #	Mfg #	Size	Price
7318	100-38	1/4" (3/8" OD)	0.13
7319	100-40	3/8" (1/2" OD)	0.13
7320	100-50	1/2" (5/8" OD)	0.13
7321	100-75	3/4" (7/8" OD)	0.13
7322	100-10	1" (1-1/8" OD)	0.16
7323	100-12	1-1/4" (1-3/8" OD)	0.19
7324	100-15	1-1/2" (1-5/8" OD)	0.26
7325	100-20	2" (2-1/8" OD)	0.35

### Natick Type Hangers

- Copper-plated carbon steel
- Used to suspend copper tubing from floor joists, used in horizontal applications
- Nails included



Part #	Mfg #	Size	Price
8549	200-1	1/2" x 6"	1.00
8550	200-2	3/4" x 6"	1.02
8551	200-3	1" x 6"	1.04
8552	200-4	1-1/4" x 6"	1.08
8553	200-5	1-1/2" x 6"	1.15
8554	200-6	2" x 6"	1.27
8555	200-7	1/2" x 12"	1.24
8556	200-8	3/4" x 12"	1.29
8557	200-9	1" x 12"	1.32
8558	200-10	1-1/4" x 12"	1.36
8559	200-11	1-1/2" x 12"	1.41
8560	200-12	2" x 12"	1.54

### PVC Hangers

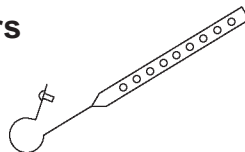

Part #	Mfg #	Size	Price
8541		1-1/2" x 12"	1.24
8542		2" x 12"	1.34
8543		3" x 12"	1.51
8544		4" x 12"	1.65

### Tube Support Bracket

- Copper plated carbon steel
- Designed to position stub outs for all types of fixtures



Part #	Mfg #	Description	Price
860921	800-51	For 1/2", 3/4" & 1" Tubing	3.33

### Thomas&Betts

### Strut

### Series 1000 Metal Galvanized Framing Channels (Strut)



- Slotted

Part #	Mfg #	Description	Price
8569	A1200	1-5/8" x 1-5/8" x 10', 12ga	3.24
8571	B-1400-10	1-5/8" x 13/16" x 10', 14ga	2.03

### Series 100 Hardware Nylon Cone Nuts



Part #	Mfg #	Size	Price
8594	CM100	3/8"	2.86
8595	CM100	1/2"	3.10

### Regular Spring Nuts



Part #	Mfg #	Size	Price
140240	A100	3/8"	2.06
57049	A100	1/2"	2.10

Prices & specifications are subject to change.

Our state of the art pipe shop offers cutting, threading, grooving and make-ons up to 36in!



## Pipe Hangers

## Superstrut®

### Series 700 Pipe and Conduit Hangers Copper Plated OD Tubing Pipe Clamps



Part #	Mfg #	Size	Price
8583	CT701	3/8" (1/2" OD)	3.18
8584	CT701	1/2" (5/8" OD)	3.04
8585	CT701	3/4" (7/8" OD)	3.38
8586	CT701	1" (1-1/8" OD)	3.75
8587	CT701	1-1/4" (1-3/8" OD)	4.31
8588	CT701	1-1/2" (1-5/8" OD)	4.50
8589	CT701	2" (2-1/8" OD)	6.09
8590	CT701	2-1/2" (2-5/8" OD)	6.78
8591	CT701	3" (3-1/8" OD)	7.43

### Pipe and Rigid or IMC Conduit Clamps

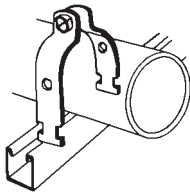

Part #	Mfg #	Size	Price
8574	702	1/2"	2.35
8575	702	3/4"	2.40
8576	702	1"	2.75
8577	702	1-1/4"	2.99
8578	702	1-1/2"	3.89
8579	702	2"	4.20
8580	702	2-1/2"	4.42
8581	702	3"	4.75
8582	702	4"	6.23



### Caddy® SLICK Threaded Strut Nuts

- Eliminates the need for a washer
- Replaces spring nuts



Part #	Mfg #	Thread Size	Recommended Torque	Price
208555	SLICK 375	3/8" - 16	15 ft lbs	1.54

### Caddy® SLICK Threaded Strut Nuts (Continued)

Part #	Mfg #	Thread Size	Recommended Torque	Price
208556	SLICK 500	1/2" - 13	20 ft lbs	1.78

### Caddy® Cushion Clamps - Tube Series

- Ideal for multiple line runs
- Shoulder stud
- "Controlled squeeze" design
- Fits standard 1-5/8" strut channel
- Thermoplastic elastomer cushion
- Patented "living hinge"
- Interlock edges and channel locator legs help ensure that the cushion remains in place



Part #	Mfg #	OD Copper & Steel	Copper Water	Price
880337	TCC0025CP	3/8"	1/4"	6.49
859318	TCC0037CP	1/2"	3/8"	6.15
798906	TCC0062CP	5/8"	1/2"	6.29
798907	TCC0087CP	7/8"	3/4"	8.05
798908	TCC0112CP	1-1/8"	1"	9.31
798909	TCC0137CP	1-3/8"	1-1/4"	11.02
798910	TCC0162CP	1-5/8"	1-1/2"	14.52
225788	TCC0212CP	2-1/8"	2"	26.84

## Supports

### Caddy® Pyramid 50 Pipe and Equipment Support

- Surface Finish: Electro-zinc plated, CADDY® COAT Silver
- Eliminates need to field-fabricate rooftop pipe supports
- Large footprints of foam bases distribute loads over wider area
- Tested for outdoor use
- 14 Gauge steel top accepts standard strut fittings



Part #	Mfg #	Size	Rec Load	Price
203647	RPS50H4EG	10-3/8" x 4" x 4"	50 lb	21.17
203648	RPS50H6EG	10-3/8" x 4" x 6"	50 lb	25.88



## Pipe Hangers



### Split Ring Hangers

#### Caddy® Superfix 454 Hanger

- Electro-zinc plated
- For suspension of stationary, non-insulated pipe lines
- EPDM Rubber insulation for sound reduction compliant with DIN 4109
- Temperature range from -58°F to 230°F
- Conforms with Manufacturers Standardization Society (MSS) SP-58 & SP-69 (Type 12)



Part #	Mfg #	Nominal Pipe Size		Price
		IP	CT	
876377	454002	3/8"	1/2"	2.52
876379	454004	1/2"	3/4"	2.68
876382	454005	3/4"	1"	2.86
876383	454006	1"	1-1/4"	3.00
876384	454007	1-1/4"	1-1/2"	3.72
876386	454008	1-1/2"	-	4.75
876388	454009	-	2"	3.98
876389	454010	2"	-	6.42



### General Purpose 1/2" Worm Gear Hose Clamps

#### Tridon® 620 Band Clamps

- 300 Series marine-grade stainless steel 1/2" Band, housing, and 5/16" hex-head screw
- General purpose 1/2" band clamps
- For applications requiring greater resistance to corrosion



Part #	Mfg #	Size	Price
8730	6204	7/32" - 5/8"	0.94
8731	620-006	3/8" - 7/8"	1.36
8732	620-008	7/16" - 1"	1.41
8733	620-010	1/2" - 1-1/16"	1.41
8734	620-016	3/4" - 1-1/2"	1.48
8735	620-020	3/4" - 1-3/4"	1.48
8736	620-024	1" - 2"	1.48
8737	620-032	1-9/16" - 2-1/2"	1.49
8738	620-040	1-1/8" - 3"	1.73
8739	620-052	1-7/8" - 3-3/4"	2.09
8740	620-072	3" - 5"	2.35



### Threaded Mounting Rods



#### Sammy Super Screw™

#### Vertical Mounting Rods (Sammy Super Screw™)

- For hanging pipe, conduit, fluorescent fixtures, unit heaters and more

#### Concrete

- Self-tapping
- 1/4" Pre-drilled hole required



Part #	Mfg #	Size	Rod	Price
207548	CST 20	1/4" x 1-1/2"	3/8" - 16	2.72

#### Steel

- Self-drilling, self-tapping



Part #	Mfg #	Size	Rod	Price
207536	DSTR 1	1/4" x 1"	3/8" - 16	2.40
207537	TEK 50	1/4" x 2"	3/8" - 16	2.36

#### Wood

- Self-drilling, self-tapping



Part #	Mfg #	Size	Rod	Price
207532	GST 10	1/4" x 1"	3/8" - 16	2.36
207533	GST 20	1/4" x 2"	3/8" - 16	2.40
207534	GST 30	1/4" x 3"	3/8" - 16	2.60
214735	GST 4	1/4" x 4"	1/2 - 13	3.00
855643	GST 2	3/8" x 2-1/2"	1/2 - 13	3.12

### Sidewinder™ Horizontal Mounting Rods

#### Steel

Part #	Mfg #	Size	Rod	Price
207547	SWDR 1	1/4" x 1"	3/8"-16	2.36
207540	SWDR 516	1/4" x 1-1/2"	3/8"-16	3.00



#### Wood

Part #	Mfg #	Size	Rod	Price
207535	SWG 20	1/4" x 2"	3/8"-16	2.72





## Mounting Rods

### Nut Drivers

- Designed to be used with the Sammy Super Screw™ anchoring system



Part #	Mfg #	Use With Rod	Color	Price
207552	#14SW	1/2" & Horizontal Mnt	Red	30.40

### Drill Bits



Part #	Mfg #	Description	Price
207553	SDS 250	1/4" Bit w/Carbide Tip for Concrete	30.40

### Rawl Steel Drop-In Shields



- The Steel Dropin is an all-steel, machine bolt anchor. It can be used in solid concrete, hard stone, and solid block.
- Internally threaded anchor for easy bolt removability and service work.

Part #	Mfg #	Size	Price
8534		1/4"	0.54
8535		3/8"	0.75
8536		1/2"	1.41
56964		5/8"	2.55

### Drop-in Setting Tools



Part #	Mfg #	Size	Rod	Price
8537		1/4" Setting Tool		4.41
8538		3/8" Setting Tool		4.41
8539		1/2" Setting Tool		4.94

### Rawl Steel Calk-In Shield / Anchor

- The Calk-In™ is a pre-assembled precision cast calking type machine bolt anchor which can be use block, brick or stone. The anchor consists of an antimony lead alloy calking sleeve and a Zamac alloy internally-threaded expander cone.



Part #	Mfg #	Size	Rod	Price
8530	9219	1/4"		0.58
8532	9240	1/2"		2.10
8533	9245	5/8"		5.09



# Drain Cleaning



## Super-Vee™ Drain Cleaners

### Super-Vee™ Kit

- Includes:
  - Basic unit (side action chuck, variable speed motor with reversing switch)
  - Case
  - HECS Cutter set
  - (1) Additional cartridge
  - Cables



Part #	Mfg #	Description	Price
16746	SV-B-WC	1/4" x 25' (25HE1) & 3/8" x 35' (35HE2) Cables	483.20

### Super-Vee™ Accessories & Parts

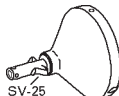

Part #	Mfg #	Description	Price
16789	SV-25	Cable Grippers	6.85
861193	HST	Handy Stand for Super-Vee™ & Power-Vee™	76.90

## Power-Vee™ Drain Cleaners

### Power-Vee™

- Feed 3/8" cable at 16 feet per minute.
- The feed handles 1/4", 5/16" and 3/8" cables - no adjustment, disassembly or additional parts required.
- Uses left hand wound Flexicore® cables for maximum strength.
- With Quick-Change Cable Cartridges.



Part #	Mfg #	Description	Price
155304	PV-N	Complete Power-Vee	211.45
886990	HS-PV-B	Complete Power-Vee w/ Handy Stand	618.10

## Mini-Rooter™ Drain Cleaners

### Mini-Rooter™ Kit

- Includes:
  - Basic unit (MR-200 drum, 1/3 hp motor with reverse switch, 10' power cord, ground fault interrupter, waterproof air foot switch, leather gloves)
  - Cable
  - MRCS Cutter set (AH arrow head, BG boring gimlet, 1-1/2" U & 1-1/2" U-cutter, 2" SCB side cutter blade)



Part #	Mfg #	Description	Price
16747	MR-B	75' x 3/8" (75EM2) Cable	561.20

### Mini-Rooter™ Parts

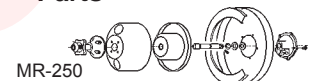

Part #	Mfg #	Description	Price
55036	MR-250	J-Drum for 1/4" or 5/16" Cables	166.90

## Mini-Rooter XP™ Drain Cleaners

### Mini-Rooter XP™ Kit

- Includes:
  - Basic unit (MR-200-2 drum, 8" wheels, 1/3hp motor with reverse switch, 10' power cord, ground fault interrupter, waterproof air foot switch & leather gloves)
  - MRCS Cutter set (AH arrow head, BG boring gimlet, 1-1/2" U & 1-1/2" U-cutter, 2" SCB side cutter blade)
  - Cable
  - Power cable feed



Part #	Mfg #	Description	Price
115015	P-XP-B	75' x 3/8" Cable (75EM2)	928.00

## Speedroter 91™ Kit

- Includes:
  - Basic unit (1/2 hp capacitor motor, large drum, ground fault interrupter, waterproof air foot switch, 20' power cord and leather gloves)
  - Power cable feed
  - Guide tube
  - SRCS Cutter set (33" flexible leader, spear head, 3" and 4" side cutter blades, 2" U cutter 3" heavy duty saw blade 4" rotary saw blade and large retrieving tool)
  - Cable



Part #	Mfg #	Description	Price
886991	PS92-E	100' x 5/8" Cable (100EM4)	1961.00

Tools

Prices & specifications are subject to change.

Metropolitan Pipe offers Vendor Managed Inventory - never run out of that part again!



# Drain Cleaning

Tools

## Kinetic Water Ram™

### Kinetic Water Ram™

- Uses a powerful slug of air to send a burst of kinetic energy to ree clogs in the line.
- Caulking hose
- 4" Rubber cone
- (5) Rubber plugs



Part #	Mfg #	Description	Price
16750	KR-A-WC	Plus Carrying Case	307.95

### Kinetic Water Ram™ Accessories & Parts

Part #	Mfg #	Description	Price
16782	KR-RK	Ram Repair Kit	22.45

## Flexicore Cable

- With male & female connectors



Part #	Mfg #	Size	Price
57414	75EM2	3/8" x 75'	138.50
16772	50EM3	1/2" x 50'	132.95
140133	75EM3	1/2" x 75'	194.35
50633	50EM4	5/8" x 50'	158.70

## Replacement Cable



Part #	Mfg #	Description	Price
16767	25HE1	1/4" x 25' w/El Basin Plug Head	35.05
16768	25HE1-DH	1/4" x 25' w/Downhead	43.60
16771	50HE1-DH	1/4" x 50' w/Downhead	68.75
120274	25HE1-DDH	1/4" x 25' w/Double Downhead	49.80
16769	25HE2	3/8" x 25' w/Female Connector	58.90
16770	35HE2	3/8" x 35' w/Female Connector	76.40

## Connectors

### Basic Connectors



Part #	Mfg #	Description	Price
111863	5/8FC	5/8" Female, Butt Weld	5.40

### Quick Fix Connectors



Part #	Mfg #	Description	Price
115887	1/2QF	1/2" Quick Fix	13.80
115890	3/4QF	3/4" Quick Fix	15.55

## Connecting Screws

Part #	Mfg #	Description	Price
115882	3/8CS	3/8", 5/Pk	2.75
115885	5/8CS	5/8", 5/Pk, For Butt Weld	2.75

## Cutters

### Handyletric™ Cutter Set

- 5-Piece set includes:

- Arrow head (AH)
- Flexible arrow head (FAH)
- 1-1/4" Side cutter blade (1-1/4SCB)
- Boring gimlet (BG)
- Down head boring gimlet (DHBG)

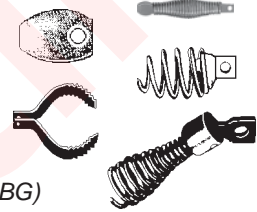

Part #	Mfg #	Description	Price
16777	HECS	For 3/8", 1/4", & 5/16" Cables	36.30

### MRCS Mini-Rooter™ Cutter Set

- Includes:

- Arrow head (AH)
- 1-1/2" U Cutter (1-1/2UC)
- 2" Side cutter blade (2SCB)
- Boring gimlet (BG)



Part #	Mfg #	Description	Price
16780	MRCS	Mini-Rooter™ Cutter Set	30.75

## Cutters For 3/8" Cable

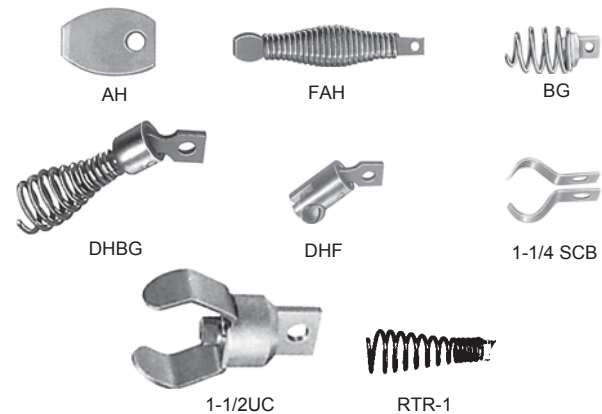

Part #	Mfg #	Description	Price
37521	AH	Arrow Head	5.05
35846	FAH	Flex Arrow Head	9.05
35845	BG	Boring Gimlet	6.85
36544	DHBG	Down Head Boring Gimlet	9.55
36545	DHF	Down Head Fitting	9.05
115868	1-1/4SCB	1-1/4" Side Cutter Blade	5.80
115869	1-1/2UC	1-1/2" U Cutter	12.15
36547	RTR-1	Small Retrieving Tool	8.00





# Drain Cleaning



## Cutters For 5/8" & 3/4" Cables

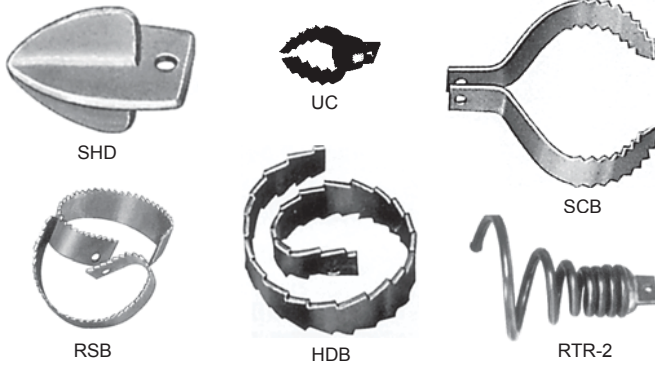

Part #	Mfg #	Description	Price
47434	SHD	Spear Head	9.75
41595	2UC	2" U Cutter	14.25
37524	2SCB	2" Side Cutter Blades	6.70
115870	3SCB	3" Side Cutter Blades	8.40
115871	4SCB	4" Side Cutter Blades	8.40
16786	6SCB	6" Side Cutter Blades	11.90
115874	3RSB	3" Rotary Saw Blades	14.85
115873	3HDB	3" Heavy Duty Saw Blade	43.05
115361	RTR-2	Large Retrieving Tool	17.50

## D-25 Handy™ Downhead (DH)

- FLEXICORE Cable units
- Can be attached to a drill



Part #	Mfg #	Description	Price
16754	D-25-2	1/4" x 25'	105.20

## Flexicore Wire Rope Center Augers

### Regular Head Less Handle

- Hand wire only



Part #	Mfg #	Length	Diameter	Price
16758	L-25FL1	25'	1/4"	33.50

### Downhead

- Complete with rotary handle



Part #	Mfg #	Length	Diameter	Price
183647	25FL1-DH	25'	1/4"	48.18
114215	50FL1-DH	50'	1/4"	72.89

## Downhead Less Handle

- Hand wire only

Part #	Mfg #	Length	Diameter	Price
16761	L-15FL1-DH	15'	1/4"	24.00
16762	L-25FL1-DH	25'	1/4"	32.00
16765	L-25FL2-DH	25'	3/8"	57.20

## Closet Augers

- With Flexicore double layer wire rope center

### Regular Head



Part #	Mfg #	Description	Price
16774	3FL	3' Flexicore	33.45
48286	T6FL	6' Teletube Flexicore	52.85

### Down Head Style



Part #	Mfg #	Description	Price
16775	3FL-DH	3' Flexicore	40.25
16776	T6FL-DH	6' Teletube Flexicore	59.85
36973	FL-DH	Down Head Only	9.10

## Urinal Augers



Part #	Mfg #	Description	Price
156979	I-U2	Regular - 29" Spring (1/Ctn)	18.65
156980	TU4	Telescoping Teletube® - 48" Spring (6/Ctn)	28.30



## Drain Inspection

Tools

### Pipe Inspecting & Locating

#### SeeSnake Micro™ Inspection Camera

- The new RIDGID® SeeSnake® micro™ Inspection Camera allows you to perform detailed visual inspection in hard to reach areas. Its comfortable pistol grip design and forward facing controls make it easy to detect and diagnose the unreachable.
- Display: 2.4" color LCD (234 X 160 Resolution)
- Camera head: Aluminum 17mm
- Lighting: 1 or 2 Adjustable LEDs
- Cable reach: 3' (expandable to 30' w/optional extensions)
- Video output: 3' RCA cable (included)
- Waterproof: camera & cable to 10' (when properly assembled)
- Power source: 4 AA batteries (6 hrs. of continuous run-time)
- Weight: 1.2 lbs (0.5 kg)



Part #	Mfg #	Description	Price
925356	31118	SeeSnake Micro™ Inspection Camera 17mm Head	260.60
910747	31123	SeeSnake Micro™ Inspection Camera 9.5mm Head	260.60

#### microEXPLORER® Digital Inspection Camera

- The new RIDGID® microEXPLORER® Digital Inspection Camera is a powerful, hand held, video inspection system that's portable enough to be carried anywhere. This completely digital platform allows you to perform and record detailed visual inspections of hard to reach areas. The microEXPLORER® Digital Inspection Camera allows you to offer more services and provides you the tools you need to detect and diagnose the unreachable.
- Display: 3.5" color LCD (320 x 240 resolution)
- Image capture: JPG images (1280 x 1024), AVI Video (320 x 240)
- Recording medium: internal memory or SD card
- Additional ports: USB and SD card
- Image controls: pan, zoom, self leveling, low light vision
- Lighting: 4 fully adjustable LEDs
- Camera diameter: 0.7" (17 mm)
- Cable reach: 3' (expandable to 30' w/optional extensions)
- Waterproof: camera & cable to 10' (when properly assembled)
- Power source: rechargeable Lithium ion battery (4 hours of continuous run time)



Part #	Mfg #	Description	Price
912394	30063	microEXPLORER® Digital Inspection Camera	792.70

#### Universal Cable Extensions

- For use with SeeSnake Micro or MicroExplorer
- Expand cable reach up to 30'

Part #	Mfg #	Description	Price
913929	31128	3' Universal Cable Extensions	55.20
913928	31133	6' Universal Cable Extensions	99.85



## General Purpose Tools

Radiator Specialty Company

### Douglas® Aluminum Levels



Part #	Mfg #	Description	Price
17044	510	9" Magnetic Torpedo Level	17.72
17046	524P	24" (6) Feature Level w/Grade Screw	72.99



### General Purpose Tools

#### Torpedo Levels

- Ideal for general use and work in tight places
- (3) Vials for plumb, level & 45° miter
- Full length strong magnetic edge
- V-Grooved edge for pipe & conduit work



Part #	Mfg #	Model	Description	Price
201148	87097	395	Large Top Read Level Vial	21.80

#### Locking Steel Tape

- Stud marks every 16"
- Locking; rewinds automatically
- Chromium-plated inside-outside case has button control for tape locking & power rewinding



Part #	Mfg #	Model	Length	Width	Price
876957	20213	636	16'	3/4"	19.70

#### Fiberglass Folding Rulers

- Precision made of flexible heavy-duty fiberglass
- With embedded easy-to-read boldface figures & graduations with red 16" stud marks & locking joints



Part #	Mfg #	Model	Description	Width	Price
17493	73360	1620	6' Extension Rule	5/8"	21.80

### Hammers

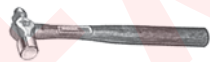

Ball Pein



Curved Claw



Ripping Claw



Sledge

Part #	Mfg #	Model	Desc	Head Wt	OA Length	Price
200771	52470	032	Ball Pein	32 oz	16"	30.95
155691	52475	116	Curved Claw	16 oz	13-1/4"	36.90
141694	52485	216	Ripping Claw	16 oz	13-1/4"	36.90
17521	52505	303	Sledge	3 lbs	10"	38.50

### Bench Vises

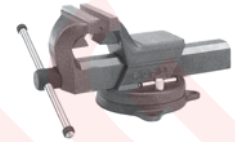

- All steel, drop forged construction
- Rolled double lead acme screw
- Standard fixed pipe jaws
- Steel handle with rubber anti-pinch rings
- Forged steel swivel base with dual draw down bolts
- Lifetime warranty

Part #	Mfg #	Model	Description	Price
157826	66987	F-45	4-1/2" Forged	266.80
144337	66997	F-60	6" Forged	467.35



### Electrical Supplies

#### Extension Cords

- UL Approved
- Orange rubber insulation



Part #	Mfg #	Description	Price
17086	1802004	12/3, 25' Round	48.32
17087	1802006	12/3, 50' Round	69.16

#### Drop Lights

- Metal cage
- UL Approved
- Orange rubber insulation



Part #	Mfg #	Description	Price
17088	1802020	16/3, 25'	42.74

#### Rough Service Bulbs

- 75 watts
- Replacement bulbs for 1802020 drop light



Part #	Mfg #	Description	Price
17090	1802100	75W	1.77

Prices & specifications are subject to change.

Our office hours are 7am to 4:30pm and counter hours 6am to 4:30pm Monday through Friday.



## Screwdriver & Nutdrivers

Tools

### Specialty Server Multi-Bit Screwdrivers

#### Megapro® 15-In-1 Tamperproof Screwdriver

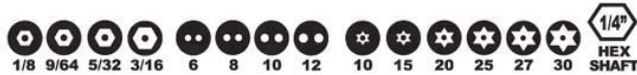

- Patented pullout bit cartridge makes it easy to find, change and store bits
- Handle is made from engineered nylon/ABS resin, Triax 1120
- Shaft opening serves as a 1/4-Inch hex driver
- Alloy steel shaft
- Palm saver cap keeps you from getting blisters on your hand
- EZ guide collar
- Palm saver cap

Part #	Mfg #	Description	Price
924289	151TP	15-in-1 Tamperproof Screwdriver Includes: Hex pin bit 1/8, 9/64, 5/32, 3/16. Spanner bit 6, 8, 10, 12. Star pin bit 10, 15, 20, 25, 27, 30.	33.94

#### Megapro® 15-In-1 Tamperproof 2 Screwdriver



- Patented pullout bit cartridge makes it easy to find, change and store bits
- Handle is made from engineered nylon/ABS resin, Triax 1120
- Alloy steel shaft opening serves as a 1/4-Inch hex driver
- Palm saver cap keeps you from getting blisters on your hand
- EZ guide collar
- Palm saver cap

Part #	Mfg #	Description	Price
950447	151TP2	15-in-1 Tamperproof 2 Screwdriver Includes: The bit load is included with this driver: Includes Tri-wing bit 2-3, 4-5, Torx bit 4-6, 8-10, Tamper resistant torx plus bit 10-15, 20-25, 27-30.	44.68

### Megapro® 14-In-1 HVAC Service Screwdriver



- Patented pullout bit cartridge makes it easy to find, change and store bits
- Handle is made from engineered nylon/ABS resin, Triax 1120
- Shaft opening serves as a 1/4-Inch hex driver
- Alloy steel shaft
- Palm saver cap keeps you from getting blisters on your hand

Part #	Mfg #	Description	Price
924290	141HVAC	14-in-1 HVAC Screwdriver Includes: 14 bit tips featuring Schrader Valve Stem bit, Square Awl Reamer bit and DoubleLOK Phillips #2 Combo bit (which can be used in any 1/4" quick change chuck)	27.76

### Megapro® 15-In-1 Original NAS Driver



- Patented pullout bit cartridge makes it easy to find, change and store bits
- Alloy steel shaft opening serves as a 1/4-Inch hex driver
- Palm saver cap keeps you from getting blisters on your hand
- Loaded with 7 double end professional quality bits, this assortment provides the 14 most popular tips for driving screws
- Palm saver cap

Part #	Mfg #	Description	Price
950448	151NAS	15-in-1 NAS Screwdriver Includes: Phillips bit 0-3, 1-2. Square bit 0-3, 1-2. Star bit 10-15, 20-25. Slotted bit 4-6.	24.58



## Screwdriver & Nutdrivers

**MEGAPRO**  
Every bit better.

### Megapro® 151ELEV-CH/OR Elevator Service Multi Bit 15 in 1 Screwdriver



- Specifically configured for Elevator service technicians
- Features a hybrid bit load made up of selected tamperproof and standard bits
- The shaft opening serves as a 1/4" hex driver
- Seven double end bits give you the 14 most popular screwdriver tips
- Palm saver cap

Part #	Mfg #	Description	Price
950449	151ELEV	15-in-1 Elevator Service Screwdriver includes: Phillips bit 0-3, 1-2. Spanner bit 6-8, 10-12. Torx pin bit 10-15, 20-25. Slot bit 4-6.	33.76

### #6 Belt Holster for Megapro Screwdrivers



Part #	Mfg #	Description	Price
919283	6	Belt Holster	10.52



### 6-in-1 Tool

#### Screwdriver Slot/Phillips/Nut Drivers

- Cushion grip handle
- Includes:
  - Nut drivers; 1/4" and 5/16"
  - Flat bits; 1/4" and 3/16"
  - Phillips bits; #1 and #2

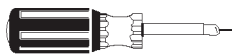

Part #	Mfg #	Description	Price
48046	72151	7-1/2" Overall Length	14.18



### Screwdrivers

- Channellock Blue™ and Code Blue™ plastic grips are not intended, recommended, or warranted for dielectric properties

#### Channellock SD-7CB Code Blue Screwdrivers 7-Piece Set

- Set includes:
  - 3/16" x 4" slotted
  - 1/4" x 6" slotted
  - 3/8" x 8" slotted
  - #1 x 4" Phillips
  - #2 x 4" Phillips
  - #3 x 6" Phillips
- Screwdriver with magnetic tips
- Screwdrivers with Go-Thru steel blades for added strength
- High torque, 3-sided Code Blue grips
- Laser etched steel caps for easy identification



Part #	Mfg #	Description	Price
920288	SD-7CB	7-Piece Screwdriver Set (Includes: S144CB, S146CB, S364CB, S388CB, P104CB, P204CB and P306CB)	28.88

### Nut Drivers

- Channellock Blue™ and Code Blue™ plastic grips are not intended, recommended, or warranted for dielectric properties

#### Channellock Code Blue Nut Drivers (Individual)



- Nutdrivers with full hollow shafts
- High torque, 3-sided Code Blue grips
- Laser etched steel caps for easy identification
- Nutdrivers made to A.N.S.I. standards in China

Part #	Mfg #	Length	Price
17004	N140CB	1/4"	5.94
155662	N516CB	5/16"	5.94
171523	N716CB	7/16"	5.94
155230	N380CB	3/8"	5.94

Tools



## Tools

Tools

### Channellock ND-7CB Code Blue Nutdriver Set, 7-Piece

- Opening Size:
  - 11/32 in
  - 1/2 in
  - 1/4 in
  - 3/16 in
  - 3/8 in
  - 5/16 in
  - 7/16 in.
- 3-Inch Blade 7-1/2-Inch Overall
- Nutdrivers with full hollow shafts
- High torque, 3-sided Code Blue grips
- Laser etched steel caps for easy identification



Part #	Mfg #	Description	Price
920284	ND-7CB	7-Piece Nut Driver Set (Includes: N132CB, N120CB, N140CB, N316CB, N380CB, N516CB, N716CB)	41.50

## SHEFFIELD

### Sheffield 12815 12-in-one Multi-Tool Plier Set (with Bonus Nylon Belt Pouch)

- Sheffield 12 in 1 Folding Multi Tool Skeleton designed to reduce carrying weight to 10.5 ounces.
- Rust free stainless steel construction.
- Folds to 4 inches.
- Sturdy pouch.
- Includes: Long Nose Pliers, Wire Cutter, Saw, Medium Slotted Screwdriver, Awl, Bottle Opener, Phillips Screwdriver, Small Slotted Screwdriver, Knife, 2 Files, Standard Pliers,



Part #	Mfg #	Description	Price
952432	12815	12-in-one Multi-tool with Pouch	19.80



## Wrenches

### Allen - Folding Hex Key Wrench Set

- Chrome-plated steel case
- Fourteen fractional U.S. sizes



Part #	Mfg #	Description	Price
18066	J40-015	14-Piece Set	9.07



## Specialty Tools

### T-Handle Hex Key Set

- Hardened, tempered steel



Part #	Mfg #	Description	Price
136048	1818137	9", 8-Piece with Carrying Pouch	23.89

## Gasket Scrapers



- Straight or angled chisel gasket scrapers

Part #	Mfg #	Description	Price
952433	45503	Straight	5.20
952434	45502	Angled/Offset	5.20



## Wrenches

- Channellock Blue™ and Code Blue™ plastic grips are not intended, recommended, or warranted for dielectric properties

### Adjustable Wrenches

- Chrome



Part #	Mfg #	Length	Capacity	Price
16966	804	4-1/2"	9/16"	14.95
16967	806W	6-1/4"	13/16"	15.91
16968	808W	8"	15/16"	17.55
16969	810W	10"	1-13/16"	21.35
16970	812W	12"	1-3/8"	30.63
16971	815	15"	1-3/4"	56.05

Prices & specifications are subject to change.



## Wrenches



### Channellock 841S SAE 4-n-1 Ratcheting Wrench Set

- Includes ratchet sizes: 5/16" x 3/8", 7/16" x 1/2", 9/16" x 5/8", 11/16" x 3/4"
- 12 point socket
- Heat-treated for greater durability on the job
- Electronic coating for ultimate rust prevention
- 4 sizes in each wrench saves time, money and space
- Hollow sockets excel over deep socket designs



Part #	Mfg #	Description	Price
941209	814S	Includes ratchet sizes: 5/16-Inch x 3/8-Inch, 7/16-Inch x 1/2-Inch, 9/16-Inch x 5/8-Inch, 11/16-Inch x 3/4-Inch	35.55

## IRWIN® Industrial Tools

### Vise-Grip® Tools Adjustable Wrench

- Durable chrome vanadium construction with hang hole
- ProTouch™ grips provide extra comfort and reduces hand fatigue
- English and metric scales
- Extra wide capacity
- Meets or exceeds ANSI specifications



Part #	Mfg #	Size	Jaw Capacity	Price
877153	2078610	10"	1-1/4"	18.84
877150	2078612	12"	1-1/2"	25.83

### Pipe Wrench

- Quick adjusting, 1-hand operation
- Ratchets quickly to work surface & has smooth release upon job completion
- Broached teeth ideal for most surfaces
- 43% Less weight than standard 14" wrench
- Ergonomic handle ideal for heavy torque



Part #	Mfg #	Size	Jaw Capacity	Price
877154	274001	11"	2-1/4"	33.16



### Tongue & Groove Pliers

- Channellock Blue™ and Code Blue™ plastic grips are not intended, recommended, or warranted for dielectric properties

#### Straight Jaw



Part #	Mfg #	Length	Capacity	Price
16955	426	6-1/2"	7/8"	11.77
16952	420	9-1/2"	1-1/2"	14.19
16956	430	10"	2"	14.76
16958	440	12"	2-1/4"	16.74
16961	460	16"	4-1/4"	27.81
162190	480	20-1/4"	5-1/2"	54.46

#### Code Blue® - Straight Jaw

- Grips have Santoprene™ core with TPR-rubber overmold



Part #	Mfg #	Length	Capacity	Price
862199	420CB	9-1/2"	1-1/2"	20.71
862196	430CB	10"	2"	21.29

#### V-Jaw

- For use on round stock and tubing



Part #	Mfg #	Length	Capacity	Price
16953	422	9-1/2"	1-1/2"	14.39
16959	442	12"	2-1/4"	16.16

#### Smooth Jaw

- For use on plated fixtures



Part #	Mfg #	Length	Capacity	Price
16951	415	10"	2"	14.76



# Tools

Tools

## Linemen's Pliers

- Channellock Blue™ and Code Blue™ plastic grips are not intended, recommended, or warranted for dielectric properties

### High Leverage Wiremaster™

- Heavy-duty



Part #	Mfg #	Length	Price
117038	349	9"	44.86

### High Leverage Rounded Nose



Part #	Mfg #	Length	Price
219968	369	9"	Call

### Code Blue® High Leverage Rounded Nose

- Grips have Santoprene™ core with TPR-rubber overmold

Part #	Mfg #	Length	Price
862197	369CB	9"	32.28

## Cutting Pliers

- Channellock Blue™ and Code Blue™ plastic grips are not intended, recommended, or warranted for dielectric properties

### Code Blue® Lap Joint

- Heavy-duty
- Grips have Santoprene™ core with TPR-rubber overmold



Part #	Mfg #	Length	Price
862200	338CB	8"	25.95

### Box Joint

- Precision made of fine polished, high carbon drop forged steel
- Cutters scientifically heat treated to hold their edge



Part #	Mfg #	Length	Price
117039	435	5"	23.80

### Code Blue® Cable Cutting

- Heavy-duty
- Grips have Santoprene™ core with TPR-rubber overmold
- Not designed for steel or ACSR cables



Part #	Mfg #	Length	Price
862201	911CB	9"	32.23

## Code Blue® End Cutters

- Grips have Santoprene™ core with TPR-rubber overmold

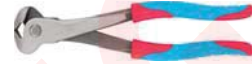

Part #	Mfg #	Length	Price
862203	358CB	8"	30.00

## Slip-Joint Pliers with Wire Cutting Shear

- Shear-type wire cutters



Part #	Mfg #	Length	Price
36854	548	8"	15.74
16963	5410	10"	13.24

## Long Nose Pliers

- Channellock Blue™ and Code Blue™ plastic grips are not intended, recommended, or warranted for dielectric properties

### Long Nose with Side Cutter



Part #	Mfg #	Length	Price
16945	326	6"	19.22
118395	317	7-1/2"	19.74

### Code Blue® Long Nose with Side Cutter

- Heavy-duty
- Grips have Santoprene™ core with TPR-rubber overmold



Part #	Mfg #	Length	Price
862198	318CB	8-1/2"	31.44

### Long Nose without Side Cutter

Part #	Mfg #	Length	Price
117036	3017	8"	13.20

### Long Reach Pliers - Needle Nose

- Designed for use in confined areas



Part #	Mfg #	Length	Price
117043	738	8"	18.51





## Tools



### Special Purpose Tools

- Channellock Blue™ and Code Blue™ plastic grips are not intended, recommended, or warranted for dielectric properties

#### Wire Stripper Cutter

- Strips insulation fast with no damage to wire
- Lean pliers nose pulls and loops wire ends
- Strips AWG wire sizes: 10, 12, 14, 16, 18, 20, and 22



Part #	Mfg #	Length	Price
173488	958	6"	12.68

#### THE CRIMPER™ Crimping Tool

- Designed for crimping both insulated and non-insulated solderless connections and terminals on 10 to 22 AWG wire
- Precision crimping dies and cutters made of fine polished high carbon drop-forged steel
- Channellock Blue® comfort grips



Part #	Mfg #	Length	Price
862208	909	9-3/4"	603.25

#### Code Blue® Crimping Tool

- Designed for crimping both insulated and non-insulated solderless connections and terminals on 10 to 22 AWG wire
- Precision crimping dies and cutters made of fine polished high carbon drop-forged steel
- Grips have Santoprene™ core with TPR-rubber overmold



Part #	Mfg #	Length	Price
862202	909CB	9-1/2"	27.70

### Radiator Specialty Company

#### Douglas® "Yellow Handle" Angle "Pump Pliers"

- Deep self-gripping, pipe-wrench style teeth
- Satin nickel-chrome plate finish
- Maximum jaw opening 2-1/8"



Part #	Mfg #	Description	Pkg Qty	Price
17047	P-813P	10" Angle Nose Pliers	5	15.04

## IRWIN® Industrial Tools

### Vise-Grip® Tools

#### Fast Release™ Long Nose Locking Pliers

- Fast Release™ is 2 times easier to open, has a no-pinch release, and offers more finger room
- Long, straight nose provides easy access in narrow, hard-to-reach places
- Ideal for tightening, clamping, twisting and turning
- Turn screw to adjust pressure and fit work
- Constructed of high-grade heat-treated alloy steel for maximum toughness and durability
- Hardened teeth are designed to grip from any angle



Part #	Mfg #	Size	Jaw Capacity	Price
877141	14T	6"	2"	18.46

#### Fast Release™ Curved Jaw Locking Pliers

- Fast Release™ is 2 times easier to open, has a no-pinch release, and offers more finger room
- Curved jaw puts pressure on 4 points on any nut or bolt head
- Ideal for tightening, clamping, twisting and turning
- Turn screw to adjust pressure and fit work
- Constructed of high-grade heat-treated alloy steel for maximum toughness and durability
- Hardened teeth are designed to grip from any angle



Part #	Mfg #	Size	Jaw Capacity	Price
877143	05T	10"	1-7/8"	17.90

#### GrooveLock Pliers

- Press and slide button quickly adjusts lower jaw
- All purpose jaw grips
- ProTouch™ grips
- Ratcheting action
- Anti-pinch design



Part #	Mfg #	Size	Jaw Capacity	Price
877145	2078108	8"	1-3/4"	18.89
877148	2078110	10"	2-1/4"	22.68
877149	2078112	12"	2-3/4"	27.21



**Tools**



Tools

**Aviation Snips - Regular with Grips**

- Cutting capacity: 18ga CR, 22ga SS
- Heavy-duty double-overwind spring guaranteed for life
- Thumb activated safety latch



Part #	Mfg #	Type	Length Of Cut	Price
116590	P6716S	Straight	1-1/2"	17.66
116588	P6716L	Left	1-3/8"	17.66
116586	P6716R	Right	1-3/8"	17.66

**Crimpers**

- Spring actuated handle action
- Heavy-duty plastic grips



Part #	Mfg #	Description	Price
157723	FCT-M-C5	5-Blade Crimper (Long)	24.42



**Lenox Aviation Snips**



- Precision-formed blades for Aviation and Bulldog Snips
- Bi-material blades for Offset Snips
- Reinforced Chrome Silicone valve-quality wire lasts for a lifetime
- Over-molded handles won't slip or twist
- Color coding on both blades and handles plus arrow icons allow for easy tool recognition
- Cutting capacity
  - Sheet metal: 18ga
  - Stainless steel: 22ga

Part #	Mfg #	Angle	Cut Length	Price
937426	22101	Left	1-3/8"	25.91
937427	22102	Right	1-3/8"	25.91
937428	22103	Straight	1-1/2"	25.91

**Lenox 22209 C5 5-Blade Sheet Metal Crimper**



- Reinforced Chrome Silicone valve-quality wire lasts for a lifetime
- Over-molded handles won't slip or twist

Part #	Mfg #	Description	Price
937425	22209	5-Blade Crimper (Long)	39.88



**Brass Plumb Bob**



- Solid brass
- Removable tip

Part #	Mfg #	Size	Price
18079	J42-008	8 oz	13.05

**Files**

**Half Round Bastard Files**

- Top quality alloy steel



Part #	Mfg #	Description	Price
18058	J41-205	8" Half Round File	10.07

**Plastic Cable Ties**

- Bag of 100



Part #	Mfg #	Size	Color	Price
18118	-	11"	White	12.03

**Straps**

**Heavy Duty Utility Straps / Bungee Cords**

- Made in the USA
- Meets or exceeds ASTM standards
- Weather and wear resistant
- Plated S-hooks



Part #	Mfg #	Size	Price
205647	S20-015	15"	7.94
205646	S20-021	21"	2.12

Prices & specifications are subject to change.



## General Purpose Tools

### Straps (Continued)

#### Heavy Duty Utility Straps / Bungee Cords

Part #	Mfg #	Size	Price
205645	S20-031	31"	2.62
205652	S20-041	41"	3.67

#### Ratchet Strap with Step Release J-Hooks

- 2" Wide
- 3,333 lb. working load limit
- Step by step release action
- Gradually releases tension with double J-Hook
- Flex grip handle



Part #	Mfg #	Size	Price
860479	S20-302	2" x 27'	76.95

### Shop Towels

#### Scott® Shop Towels On A Roll

- 11" x 10.4" (Sheet Size), 55 sheets each
- Soft, strong and absorbent which makes them perfect for automotive and workshop tasks
- Super strong - works when wet!
- Easily absorbs liquids, oils and grease
- Fits on a standard towel holder for convenient dispensing of a fresh, clean towel



Part #	Mfg #	Description	Price
904570	75130KC	Shop towel, Roll	7.33

#### Cotton Plumbers Handy Towels

- Heavy duty shop towels
- Washable, reusable and non-abrasive



Part #	Mfg #	Description	Price
875001	B05-004	(12) Towels Per Bag	7.48

#### Box of Rags

- Colored cotton sweatshirt material
- 100% Recycled
- Pull-out dispensing



Part #	Mfg #	Description	Price
145396	B05-001	5 lb Box of Rags	9.22

### Contractor Trash Bags

- Hundreds of uses
- Keep the jobsite clean
- 42 gallon 3 mil./10 per bag



Part #	Mfg #	Description	Pkg Qty	Price
875002	G02-042	42 gal, 3 mil	10	17.21

### Neon Chalk Line

- Push-button line release
- Can be used as a plumb bob
- 3-1/2 Times faster reel



Part #	Mfg #	Description	Price
182687	J40-092	8 oz Blue Chalk Line Refill	4.09

## IRWIN® Industrial Tools

### Marking and Layout

#### Fast Retrieve Reel and Chalk Combo

- 3-1/2 Times faster than a standard chalk reel
- Crank handle clutch release allows release of the line without spinning the crank handle
- Lightweight, ABS, impact-resistant case increases durability
- Patented hook storage and door locking mechanism virtually eliminates spills and line tangles
- Twisted cotton line holds 2 oz of chalk for multiple line strikes



Part #	Mfg #	Description	Price
877139	64494	100' Blue Chalk Reel, 4 oz	12.87

#### Sharpie Markers



Part #	Mfg #	Description	Price
877179	30101-99	Fine Tip Black	1.26
877178	15001	King Size Black	1.63
877177	32721-SH	Retractable Black	2.51

Prices & specifications are subject to change.

Metropolitan Pipe offers FREE DELIVERY in the Greater Boston area.



## General Purpose

### LA-CO Valve Action Paint Marker



- Marks with real, lead free paint
- Dries in 3 minutes
- Long-lasting weather-, water- and UV-resistant
- Durable, 1/8"-thick nib
- Vapor-lock cap seals nib to prevent tip dry-out
- Marking range: -50°F to 150°F

Part #	Mfg #	Description	Price
905295	96800	White - Valve Marker	4.77
905296	96801	Yellow - Valve Marker	4.77
905297	96802	Red - Valve Marker	4.77
924099	96804	Aluminum - Valve Marker	4.77
905298	96805	Blue - Valve Marker	4.77

### Lumber Crayon - Yellow

- Clay based formula provides longer marking mileage.
- Dimensions: 1/2" hex by 4 5/8" long.

Part #	Mfg #	Description	Price
16579	80321	Yellow - Lumber Crayon	1.11

## Plumbing Specialty Tools

### Extract-A-Drain Tub Drain Removal Tool



- Removes old or rusty drains
- Prevents damage to your tub's finish

Part #	Mfg #	Description	Price
210062	J40-018	Fits Both 1-1/4" & 1-1/2" Tub Drains	35.42

### Faucet Handle Pullers

- Removes faucet and valve handles
- Plated steel

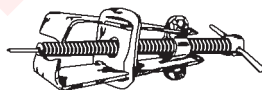

Part #	Mfg #	Description	Price
191684	J40-011	Heavy-Duty Impact Unit	21.25



## Join our e-mail newsletter!

Receive special deals and promotions, new product announcements, contests and more in your inbox every month!



## Hydrant Accessories

### Hydrant Key

- Key for Z1300 wall hydrant

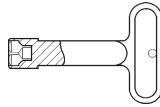

Part #	Mfg #	Description	Price
12380	59546-001	Key Only	20.00

## PASCO

### Plumbing Specialty Tools Moen® Stem & Cartridge Puller

- Removes brass cartridges, brass stems, plastic stems & cartridges
- High quality steel components
- 1-Piece construction



Part #	Mfg #	Description	Price
138167	7040	Cartridge Puller	23.80

### Tools

#### Radiator Spud Wrench



Part #	Mfg #	Description	Price
18002	4558	For 1/2" Thru 2" Spuds	18.42

#### 3-in-1 Radiator Repair Tool

- Extracts broken air valves, re-taps radiator and re-threads air valves



Part #	Mfg #	Description	Price
18008	1822002	3-in-1 Radiator Repair Tool	5.79



## Petersen

### Drain Flushers

#### DrainJet™ Drain Flushers

- Opens clogged drains fast
- Expands under water pressure
- Built-in backflow preventer
- Attaches to garden hose
- Ecologically safe, no chemicals

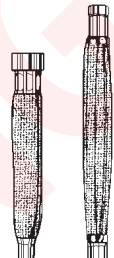
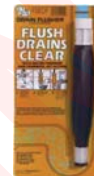

102-002 102-004

Part #	Mfg #	Size	Price
18025	102-001	1-3/8" to 1-1/2"	34.64
18026	102-002	1-1/2" to 2-1/2"	40.55
18027	102-003	2-1/2" to 3"	59.31
18028	102-004	3" to 4"	66.24
18029	102-006	4" to 6"	98.96



### Faucet Nut Splitter

- Splits old or new zinc or brass nuts in seconds
- Aluminum with a chisel tip of hardened tool steel



Part #	Mfg #	Description	Price
134448	NS-1	Fits Over All 1/2" Faucet Shanks	48.96

### Plumber's T-Handle Torque Tools

- No-hub torque wrench with unique locking collar
- Slips internally when proper torque achieved



Part #	Mfg #	Socket	Type	Force	Price
18106	2-S	5/16"	2-3/4" Shaft	60 in lbs	57.60
18105	8-A	3/8"	Anaheim	80 in lbs	65.50

### Golden Grip® Internal Pipe Wrench

- Revolutionary design can't damage threads and can remove the most stubborn nipples.



Part #	Mfg #	Description	Price
865758	97250	Single 1/2"	41.36

Tools



## Tools

Tools

### Golden Grip® Internal Pipe Wrench (Continued)

Part #	Mfg #	Description	Price
879959	97251	Single 3/4"	48.27

### Mat 4-way Seat Wrench Set

- Hex End Wrench
- Square End Wrench
- Ratchet Wrench
- Wrench for Eljer



Part #	Mfg #	Description	Price
18022	861	4-way Seat Wrench Set	26.91

**Radiator Specialty Company**

### Professional Plumber's Tools

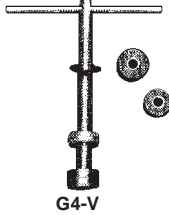

G4-V



T-2010

Part #	Mfg #	Description	Price
134999	G4-V	Faucet Seat Grinder	4.44
17048	T-2010	Faucet Handle Puller	6.09

### Gunk® Force Cups

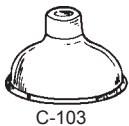

C-103



C-107

Part #	Mfg #	Description	Price
18125	C-101	Utility Force Cup 4-1/2"	2.78
18126	C-103	Sealmaster® 6"	2.99
18129	C-107	Free Flo 6"	5.06

### E-Z 4-n-1 Wrench for Symmons Valves

- Tool for replacing hot and cold seats for pressure balancing valves
- Removes diverter cap



Part #	Mfg #	Description	Price
212019	SYMM	Symmons 4-n-1 Wrench	25.20



### Inside Pipe Cutters



Part #	Mfg #	Description	Price
888771	20.09.0.1	Heavy-Duty Inside Pipe Cutter with Hex Drill Fitting	10.00
888772	BLADE	Replacement Blades (5-Pack)	21.00



### Specialty Wrenches

#### Radiator Spud Wrench

Part #	Mfg #	Description	Price
18002	1818120	Domestic Spud Wrench	18.42

#### Seat Wrench



- Forged steel tool to extract most sizes of faucet seats
- Features smooth, tapered ends

Part #	Mfg #	Description	Price
18119	1818126	Straight Seat Wrench	3.26

### Basin Buddy® Basin Nut Wrench

- Fits around supply line and 1/2" faucet shank
- Even pressure around nut to avoid stripping
- Fits 2, 3 & 4 wing PVC locknuts
- Fits brass ball cock nuts



Part #	Mfg #	Description	Price
800990	1890002	Universal Basin Nut Wrench	37.37

### Specialty Tools

#### Handy Hand Pick-Up Tool



Part #	Mfg #	Description	Price
18116	1824504	Pick-Up Tool	15.79



## General Purpose Tools

### Non-Asbestos Joint Runner



Part #	Mfg #	Description	Price
17759	1823002	#1, 2" to 4" Pipe	22.11
17760	1823004	#2, 5" to 6" Pipe	24.74
17761	1823006	#3, 8" to 10" Pipe	33.16
17762	1823008	#4, 12" to 14" Pipe	38.95

### Oakum

- Original Oakum with benonite - expands over 10 times when wet
- Baled in coils or cut length
- No tar in brown oakum

Part #	Mfg #	Description	Price
9913	O15-001	Brown Random Cut, (10) 5 lb Bags	45.48
9914	O15-002	White 3/8" Cord, (6) 10 lb Coils	102.27

### Non-Asbestos Graphite Pack Spools

- Individually spooled in 1/4 lb spools
- Re closable



Part #	Mfg #	Size	Price
18651	1900004	1/8"	28.21
18653	1900002	1/4"	9.79

### Steam Specialities

#### 4-in-1 Radiator Handle

- Includes (3) lugs to fit most radiator valves



Part #	Mfg #	Description	Price
52158	1705006	Fits (4) Sizes of Stems	1.26

### Lampwick Balls



Part #	Mfg #	Description	Price
18378	1906018	2 oz Fine	1.39

### Magna Tools

#### Domestic Pipe Taps



Part #	Mfg #	Size	Drill Size	Price
17765	1820002	1/8"	11/32"	7.26
17766	1820004	1/4"	7/16"	9.58
17767	1820006	3/8"	9/16"	14.00
17768	1820008	1/2"	3/4"	29.79
17769	1820010	3/4"	7/8"	36.42
17770	1820012	1"	1-1/8"	58.32
17771	1820014	1-1/4"	1-1/2"	75.16
17772	1820016	1-1/2"	1-3/4"	109.68
17773	1820018	2"	2-1/4"	156.42

### Screw Extractors



Part #	Mfg #	Size	Drill Size	Price
18112	1843002	#4, 1/8"	1/4"	4.00
18113	1843004	#5, 1/4"	17/64"	4.74
18114	1843006	#6, 3/8"	13/32"	9.16
18005	1843008	#7, 1/2"	17/32"	17.16
18006	1843010	#8, 3/4"	13/16"	24.95
18115	1843012	#9, 1"	1-1/8"	38.32

### Handles

#### Grip-Tite Handles



Part #	Mfg #	Description	Price
18369	1632002	Cross Handles, Pair	8.11
18368	1633002	Lever Handles, Pair	7.58

### Caulking

#### Steel Solder Ladle



Part #	Mfg #	Description	Price
17758	1804006	4" Diameter Ladle	12.53



## General Purpose Tools

Tools

### Standard Lead Furnaces

- Standard models accommodates 6" or 8" melting pots
- Made of gray iron castings
- Melts 40 lbs lead in 5 minutes

CIRCLE MANUFACTURING CO.



A1-101

Part #	Mfg #	Description	Price
213169	A1-101	Lead Furnace Body	106.62
194259	A1-101S	Lead Furnace Stand Only	52.79

### Cast Iron Solder Pot

- High quality casting

Part #	Mfg #	Diameter	Price
17739	1805006	8"	31.89



### Plumbing Lead Joining Caulking Irons

#### Ceiling Iron



Part #	Mfg #	Description	Price
17108	30001	5/8" x 14" Square End	35.20

#### Right & Left Irons



Part #	Mfg #	Description	Price
892967	30005	5/8" x 10" x 3/36" Left	29.58
892969	30006	5/8" x 10" x 3/36" Right	29.58

#### Broad Curved Nose Irons

- Square end



Part #	Mfg #	Description	Price
17109	30013	5/8" x 8-1/2" x 1-7/16"	21.60

#### Straight Irons



Part #	Mfg #	Description	Price
17110	30016	5/8" x 7" x 1/8" Outside	20.18
17111	30017	5/8" x 7" x 1/8" Inside	20.18

#### Curved Irons



Part #	Mfg #	Description	Price
17112	30018	5/8" x 6-1/2" x 1/8" Inside	20.98
17113	30019	5/8" x 6-1/2" x 1/8" Outside	20.98

### Spring Yearning Iron



Part #	Mfg #	Description	Price
17120	30033	5/8" x 10" x 1/8"	20.30

### Offset Yearning Irons



Part #	Mfg #	Description	Price
205401	30027A	5/8" x 12" x 1/8"	22.30

### Trimming Iron

- 3/4" Blade width



Part #	Mfg #	Description	Price
892970	30050	1/2" x 9" x 3/16"	20.36

### Caulking Iron Set

- Includes:
  - 30013 Broad Curved Nose Packing Iron
  - 30016 Outside Straight Iron
  - 30017 Inside Straight Iron
  - 30018 Inside Offset Iron
  - 30019 Outside Offset Iron
  - 30020 Inside Curved Offset Iron
  - 30021 Outside Curved Offset Iron
  - 30024 Long Curved Blade Offset Iron
  - 30027A Offset Yearning Iron
  - 44343 3# Caulking Hammer
  - 10S Heavy Duty 10 Pocket Pouch



Part #	Mfg #	Description	Price
892972	30080	10-Piece Caulking Set	240.00

### Cold Chisels



Part #	Mfg #	Description	Price
17101	11106	3/4" x 5/8" x 7"	7.34
17102	11109	1" x 7/8" x 9"	12.26





## General Purpose

### Oil-Dri® Premium Absorbants

- Non-toxic, virtually dust-free product absorbs aggressive and non-aggressive fluids in minutes and leaves no residue



Part #	Size	Price
35781	50 lb Paper Bag	23.34

### Cement Mix

Part #	Mfg #	Size	Price
16478	Cement Mix	25 lb Bag	6.45

### Marble Chips

Part #	Mfg #	Size	Price
14898	Marble Chips	#8 Large, 50 lb Bag	13.58

### Cement Block



Part #	Mfg #	Size	Price
35445	Cement Block	4" x 8" x 16"	2.80

**Custom Pipe Labels**  
 WHILE YOU WAIT!

*See page 362 for more details.*



Tools



## Brushes

Tools

### Fitting Brushes

#### #6100 Standard Carbon Steel

- Good - quality A
- Heavy gauge galvanized stem wire
- Single stem, single spiral construction
- Crimped high-carbon fill material



Part #	Mfg #	Pipe Size	Price
17745	61070	1/4"	3.01
17746	61150	3/8"	2.71
17747	61210	1/2"	2.59
17748	61330	3/4"	2.68
17749	61450	1"	3.35
17750	61500	1-1/4"	3.73
17751	61560	1-1/2"	4.00
17752	61620	2"	4.75

#### #6800 All Stainless Steel, "Quick Twist" Brush

- Superior - quality AA
- Meets Mil and/or ASTM specs
- Spark proof and rust-resistant
- Only all stainless steel fitting brush



Part #	Mfg #	Nominal (ID)	Actual (OD)	Price
17753	68120	2-1/2"	2-5/8"	6.71

### Power Brushes - Hex Shank

#### #6600 Hex Shank Power Fitting Brushes

- Superior - quality AA
- Carbon steel (plumbing) - bulk
- 1/4" Hex shank power fitting brush



Part #	Mfg #	Nominal (ID)	Actual (OD)	Price
201686	66430	1/2"	5/8"	4.56
201687	66450	3/4"	7/8"	4.61
202108	66470	1"	1-1/8"	4.85

#### #6200 Series Power Tube Cleaning Brushes

- Use for solder or brazed fittings
- 1/4" Hex shank tube cleaning brushes

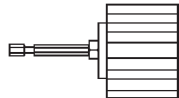

Part #	Mfg #	Description	Price
201688	62350	1/2", Bagged	6.92
201689	62370	3/4", Bagged	7.59
202109	62390	1"	8.01

### Power Brush, Nutdriver and Screwdriver Kits

- Includes:
  - 1/4" Hex shank power fitting, tube cleaning brushes in a range of sizes
  - Magnetic power nut drivers
  - Screwdriver bits



Part #	Mfg #	Description	Price
199730	72155	Plumbing Kit	70.94

### Power-Deuce Brushing Tools

- Fitting brush & O.D. tube brush for use with a cord less drill or power driver
- Self cleaning
- Durable ABS housing & rust-proof stainless steel bristles for plumbing or HVAC projects



Part #	Mfg #	Size	Price
224988	62821	1/2"	16.90
224989	62831	3/4"	17.48

### Power Brush Adapters

#### Quik-Change Chuck Adapter

- Change power brushes and other 1/4" hex-shank tools fast
- Inserts in 1/4" & 3/8" drill chucks



Part #	Mfg #	Description	Price
201684	70420	Display Bag 5/Pk	14.33

### Maintenance Brushes

#### Economy Paint Chip and Applicator Brushes

- Economical throw away brushes



Part #	Mfg #	Size	Price
18109	70440	1" Width	1.12
18110	70450	1-1/2" Width	1.55
18111	70460	2" Width	1.76



## Brushes

Tools



### Flue & Boiler Tube Brushes Weil-McLain Specialty Boiler Brushes



Part #	Mfg #	Description	Price
878527	84208	3" Dia 42" OAL, Ultra Oil Series	10.58

### Four-In-One Multi-Use Brush

- High impact engineered plastic



Part #	Mfg #	Size	Price
117117	70264	1/2" x 3/4"	10.00

### Applicator Brushes

#### Acid, Solder Paste & Flux, Adhesive

- Coated tin paste, bright-finished metal handle
- Pure medium stiff, black, graded natural horsehair bristles

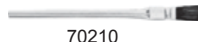

70210



70240

Part #	Mfg #	Size	Wire	Price
17755	70210	#1	1/4"	0.15
17756	70240	-	1"	1.11



### Brushes Wire Brush

- Stiff steel wire bristle
- Polished hardwood handle



Part #	Mfg #	Size	Price
18075	B29-900	1"	3.05

## GENERAL

### Multimeters

#### General HVAC Digital Service Multimeter

- Measures AC/DC voltage, AC/DC current, resistance, continuity, diode integrity, transistor hFE (current gain)
- 34 overload-protected ranges
- Jumbo 3-1/2-digit (1999 count) LCD
- Protective boot with 3-position tilt stand
- Low battery alert
- Includes:
  - All weather test leads
  - Rubber Holster
  - Battery
  - Users manual



Part #	Mfg #	Description	Price
924287	DMM51FSG	Digital Service HVAC Multimeter	60.00

### Infrared Thermometers

- Ideal for most applications in HVAC/R, plumbing and heating, electrical, automotive and other industrial jobs- Infrared thermometers work by capturing and measuring the invisible infrared energy naturally emitted from all objects. They offer an easy and safe method to instantaneously measure surface temperatures of objects which are difficult or unsafe to contact.

#### GENERAL IRT206 - HEAT SEEKER™ 8:1 Mid-range Infrared Thermometer

- The Heat Seeker has a rugged, ergonomic design and features a backlit LCD display with built-in laser sighting.
- The practical distance-to-spot ratio of 8:1 is suitable for most consumer and commercial applications.
- Rugged and ergonomic design
- Backlit LCD display
- Sighting laser can be turned off
- °F/°C selectable
- CE, RoHS, WEEE approved
- Includes battery and users manual



Part #	Mfg #	Description	Price
924286	IRT206	Range: -4°F to 604°F	60.00

Prices & specifications are subject to change.

You can check stock availability, pricing and place orders online at [www.MetPipe.com](http://www.MetPipe.com).



## Test Instruments



### GENERAL IRT105 - 6:1 Pocket-Sized Infrared Thermometer

- Optimized measurement range
- Accuracy of 3F or 2% above 32F
- Adjustable emissivity
- Fast response time
- Max/Min measurement and measurement lock modes
- Selectable F or C unit
- Large LCD
- Separate batteries for thermometer and laser
- Small and light and easy to use



Part #	Mfg #	Description	Price
912961	IRT105	Range: -40°F to 482°F	34.99

### Gas & Leak Detectors

#### Digital Carbon Monoxide Detector with Auto Zero

- Auto zero, Auto calibration
- LCD display with backlight
- Dual display: CO reading & max. hold every second.
- 3 points of CO calibration: 0 - 100 - 500 ppm.
- Audible alert triggers above 35 ppm, indicating threshold of dangerous CO concentration.
- High repeatability/selectivity to carbon monoxide (CO)
- Includes:
  - (3) "AAA" Batteries
  - Operation manual
  - Wrist strap
  - Carrying Pouch



Part #	Mfg #	Description	Price
881129	DCO1001	CO Range: 0-999PPM	11.52

### Inspection Mirrors

#### M557 Inspection Mirror

- Adjusts to any angle
- Chrome plated brass handle
- 2 1/4" round glass
- 7" arm extends to 12-1/2"



Part #	Mfg #	Description	Price
881130	M557	Glass Inspection Mirror	12.30



### Rogers Gas Tester with Case

- Gas Tester Kit - Unique brass tee connects to 1/2" or 3/4" male fitting; packaged in ABS foam lined case, small & easy to use; new gauge minimizes returns due to over inflation damage



Part #	Mfg #	Description	Price
15347	RGT	Rogers Dial Gas Tester	92.40
15348		Bulb & Hose for Dial Gas Tester	12.81
115990	RGG	Gauge for Rogers Dial Gas Tester	49.35

### Test Pumps

#### Air Test Pump 0-150 PSI

- Heavy duty hand-operated air pump.
- Made of non-corroding polyethylene.
- Extra large barrel moves air quickly with less effort.
- 4' non-kinking hose
- Quick connect thumb valve
- Large easy grip handle.
- 2" 0-150PSI gauge.



**PASCO**

Part #	Mfg #	Description	Price
920825	1424	Test Pump 0-150 PSI	40.54



### Hand-Operated Hydrostatic Test Pumps

#### Model 29100

- Ideal for testing residential water lines
- Ideal for pressure testing small pressure tanks sprinkler, boiler & solar systems
- Light weight & easy to use
- 3/4" Garden hose inlet & 1/4" NPT outlet
- Includes:
  - Shut-off valve
  - Gauge & pressure relief valve



Part #	Mfg #	Description	Price
162013	29201	1000 psi	256.00



## Safety Gear



### Ear Safety

#### Twisters Ear Plugs

- Tested by an independent, NVLAP accredited laboratory – 25 db NRR.
- Extremely soft yet durable enough to wash and wear for long-term use.



Part #	Mfg #	Description	Price
904238	93012	Purple Silicone Corded Earplugs	2.45

#### SoundChoice Earmuffs

- Three-position/di-electric black & blue earmuff



Part #	Mfg #	Description	Price
904239	95034	SoundChoice Earmuffs	11.74

### Safety Glasses

#### StarLite Safety Glasses

- Incredibly light, all-around impact protection.
- Scratch-resistant, hard coated 100% poly carbonate lenses
- Snug and comfortable fit.
- Lens blocks more than 99.9% of UV-A and UV-B light.
- Meets or exceeds ANSI Z87.1+ standard



Part #	Mfg #	Description	Price
904225	440M	Clear Lens	8.10
904226	441M	Red Lens	8.10
904227	446M	Mocha Lens	8.10
904228	447M	Gold Lens	8.10
904229	448M	Silver Lens	8.10
904230	449M	Blue Lens	8.10

#### Scorpion Safety Glasses

- Adjustable length temples and finger-tip nosepiece offer custom, flexible fit.
- Frame support behind lens provides added durability yet lightweight for extreme comfort.
- Scratch- and impact-resistant, hard coated lens blocks more than 99.9% of UV-A and UV-B light.
- Free "Scorpion's Tail" retainer helps prevent loss and damage.
- Meets or exceeds ANSI Z87.1+ standard.



Part #	Mfg #	Description	Price
904232	16GB0M	Clear Lens	12.20

### Safety Glasses (Continued)

#### Scorpion Safety Glasses

Part #	Mfg #	Description	Price
904233	16GB1M	Red Lens	12.20
904234	16GB6M	Mocha Lens	12.20
904235	16GB7M	Gold Lens	12.20
904236	16GB8M	Silver Lens	12.20
904237	16GB9M	Blue Lens	12.20

#### Scorpion Mag Safety Glasses

- Bifocal design is available in three diopter strengths– 1.5, 2.0, and 2.5.
- Adjustable length temples and fingertip nosepiece offer custom, flexible fit.
- Hard coated lens is scratch-resistant.
- Free "Scorpion's Tail" retainer helps prevent loss and damage!
- Meets or exceeds ANSI Z87.2+ standard.



Part #	Mfg #	Description	Price
905556	16MC10	Clear Lens, 1.0 Mag	12.84
905558	16MC15	Clear Lens, 1.5 Mag	12.84
905559	16MC20	Clear Lens, 2.0 Mag	12.84
905560	16MC25	Clear Lens, 2.5 Mag	12.84
905561	16MG10	Gray Lens, 1.0 Mag	13.50
905562	16MG15	Gray Lens, 1.5 Mag	13.50
905563	16MG20	Gray Lens, 2.0 Mag	13.50
905564	16MG25	Gray Lens, 2.5 Mag	13.50

#### Coverall Safety Glasses

- Generous size, specifically designed to wear over prescription eyewear
- Single-piece lens with molded-in side shields wraps around for unobstructed field of vision
- Lightweight, impact-resistant poly carbonate lens offers solid protection and blocks more than 99.9% of UV-A and UV-B light
- Meets or exceeds ANSI Z87.1 and CSA Z94.3 standards



Part #	Mfg #	Description	Price
905565	6880	Clear	11.35
905567	6883	Gray	11.35

Tools

Prices & specifications are subject to change.

We offer a variety of GREEN products such as flush valves, faucets, showerheads & more!



## Safety Gear

Tools

### Head Safety

#### Serpent Ventilated Safety Helmet

- Lightweight – just 13.1 ounces.
- CoolSense Air flow system lets heat escape.
- Soft, six-point nylon suspension.
- Adjusts to fit 6 5/8 – 8 1/4 head sizes.
- Complies with ANSI standard for Type I, Class C only.



Part #	Mfg #	Description	Price
904240	71200	White	11.52
904241	71203	Blue	11.52



### Kneepads

- Lightweight and water-resistant
- Comfortable while kneeling, standing or walking
- Won't pinch or bind behind knee
- Velcro closures on straps
- Soft, breathable inner lining for coolness and comfort



Part #	Mfg #	Description	Price
874995	K01-2000	Heavy Duty Knee Cap	31.22

## IRWIN® Industrial Tools

### Kneepads

#### All-Terrain Kneepads

- Breathable perforated Neoprene material
- No slip, non-skid cap
- Comfort straps prevent binding behind knee



Part #	Mfg #	Description	Price
877175	433002	Foam Comfort Shaped Cushion	25.82

### Swivel-Flex Kneepads

- Lightweight, flexible material
- Easy fasten front strapping system



Part #	Mfg #	Description	Price
877174	433001	Maneuverable Compact Swivel Cap	18.89

### Work Gloves

#### Heavy Duty Job Site Work Gloves

- For harsh applications & rough materials
- TechnoGrip® reinforced palm, thumb and fingertips
- Slick hook and loop fastener does not snag or collect debris
- Breathable stretch materials
- 1-Hand strap adjustment
- Knuckles padded with perforated Neoprene



Part #	Mfg #	Size	Price
877172	432001	Large	25.61
877173	432002	X-Large	25.61

### Leather Gloves



Part #	Mfg #	Description	Price
139931	G50-208	Driver's Style Leather, Carded	13.87



### Gloves

#### White Cotton Gloves



Part #	Mfg #	Description	Price
224032	G50-206	White Cotton Gloves	3.16



## Tools

### Brown Cotton Jersey Gloves



Part #	Mfg #	Description	Price
141225	G50-210	Brown Cotton Jersey	2.67

### Nitrile Vinyl Gloves

- Disposable
- 100/Box



Part #	Mfg #	Description	Price
904247	7500PFM	Medium	16.34
904259	7500PFL	Large	16.34
904249	7500PFXL	Extra Large	16.34
904250	7500PFXX	Extra Extra Large	16.34

### Showa B0500 Polyurethane Coated Palm Fit Gloves

- Specialty gloves prevent fingerprints on products and protect against micro damage
- Seamless, 13-gauge nylon construction with knit wrist cuffs assure comfortable, all-day wear
- Anti-skid, polyurethane-coated palm offers superior grip and abrasion resistance



Part #	Mfg #	Description	Price
905571	B0500	Medium	5.80
905572	B0500	Large	5.80
905573	B0500	Extra Large	5.80
905574	B0500	Extra Extra Large	5.80

### Dust Masks

- Disposable
- Non-toxic



Part #	Mfg #	Description	Price
896105	G30-021	Dust Mask 50/Pk	13.05

### Disposable Coveralls

- Tear & puncture resistant



Part #	Mfg #	Description	Price
874999	B05-020	Large Disposable Coveralls	4.43



### Flashlights

#### AA-Cell Mini Maglite Flashlight

- High-intensity light beam
- 1/2 turn, twist focus, spot-to-flood
- Patented Candle Mode
- Spare lamp safely secured in the tail cap
- High-strength aluminum alloy case
- O-ring sealed for water resistance
- Vented tail cap (patented) reduces chance of gas buildup
- Compact/lightweight construction
- Limited Lifetime Warranty
- Includes Holster



Part #	Mfg #	Battery	Color	Length	Price
167714	M2A01H	(2) AA	Black	5"	20.86
903199	M2A03H	(2) AA	Red	5"	20.86
903200	M2A11H	(2) AA	Blue	5"	20.86

#### C-Cell Maglite Flashlight



- High-intensity light beam
- 1/2 turn, cam action focus, spot-to-flood
- Self-cleaning rotary switch, 3 position, On, Off, and Signal (Manual, Momentary On-Off)
- Smaller & lighter than the D cell
- Spare lamp safely secured in the tail cap
- High-strength aluminum alloy cases
- O-ring sealed for water resistance
- Limited Lifetime Warranty

Part #	Mfg #	Battery	Color	Length	Price
903201	S2C016	(2) C	Black	8-15/16"	25.78

Prices & specifications are subject to change.

Our state of the art pipe shop offers cutting, threading, grooving and make-ons up to 36in!



# Flashlights



Tools

## Flashlights (Continued) C-Cell Maglite Flashlight

Part #	Mfg #	Battery	Color	Length	Price
903202	S3C016	(3) C	Black	10-7/8"	29.38

## D-Cell Maglite Flashlight



- High-intensity light beam
- 1/2 turn, cam action focus, Spot-to-flood
- Self-cleaning rotary switch,
- 3 position, On, Off, and
- Signal (Manual, Momentary On-Off)
- Spare replacement lamp safely
- secured in the tail cap
- High-strength aluminum alloy cases
- O-ring sealed for water resistance
- Limited Lifetime Warranty

Part #	Mfg #	Battery	Color	Length	Price
903203	S2D016	(2) D	Black	10"	28.24
903204	S3D016	(3) D	Black	12-11/32"	31.12
904253	S6D01X	(6) D	Black	19-1/2"	32.43
904254	S6D03X	(6) D	Red	19-1/2"	32.43

## Flashlight Parts/Accessories

### Leather Belt Holder

- Holds a C or D cell size Maglite
- Full grain leather
- Limited lifetime warranty



Part #	Mfg #	Fits	Price
903207	ASXC046	C-Size Maglite	6.98
903209	ASXD036	D-Size Maglite	8.62

### Replacement Bulbs

- Package of 2 replacement bulbs



Part #	Mfg #	Replacement For	Price
176260	LM2A001	AA Mini Maglite	3.58
903205	LWSA301	3-Cell C&D Maglite	4.11
903206	LWSA201	2-Cell C&D Maglite	4.11

# IRWIN® Industrial Tools

## Tool Organizers

### Pro Large Tool Organizer

- Large capacity storage
- Open at the top for quick and easy access
- False bottom provides separate storage for important items
- Water-resistant durable plastic bottom
- Reinforced handle with extra strength rivets
- Made from durable 600D Polyester
- Ergonomically designed, soft, rubberized handle



Part #	Mfg #	Size	Price
877238	420-002	17-1/2" x 13" x 14"	62.43

### Pro Soft Side Tool Organizer

- Small, lightweight and strong
- Zippered for secure transport
- Padded handle features reinforced stitching for extra strength
- Extra-wide opening provides easy access to all tools
- Made from durable, 600D Polyester
- Industrial-grade metal clasps provide added strength for heavy loads
- Uniquely configured pockets are reinforced on the bottom to resist wear and punctures



Part #	Mfg #	Size	Price
877169	420-003	15" x 10-1/2" x 9-1/2"	27.73





## Tool Boxes & Totes



### Pro Utility Tool Organizer

- Large capacity to carry a broad range of tools and accessories
- Pockets and compartments designed to provide better organization
- Reinforced rivets throughout for added durability
- Ergonomically designed, soft, rubberized handle
- Industrial-grade metal clasps provide added strength for heavy loads



Part #	Mfg #	Size	Price
877170	420-004	13-1/2" x 11" x 8-1/2"	37.44



### Tool Boxes

#### Lock 'N Load Heavy Duty Drybox

- Drybox locks out moisture, dirt, and grime
- (3) Compartments store and organize tools and accessories
- Top compartment is ideal for small tools and parts
- 



Part #	Mfg #	Size	Price
212404	75605	15" x 8" x 10"	32.58

### Batteries

**DURACELL®**

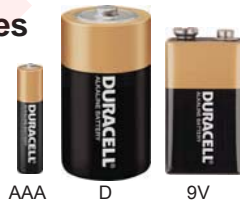

Part #	Size	Price
876623	AAA	5.00
876624	AA	4.00
876626	C	5.57
876627	D	6.40
876628	9V	5.00

### Electrical Tape



Part #	Size	Price
17062	3/4" x 60'	1.68

Tools

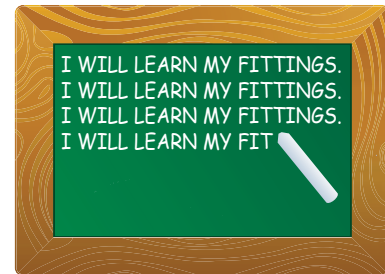

## Product Training

*Met Pipe offers training on every product we sell- from pumps to boilers. Let us organize a group training session for your team today!*



## Tools

Tools

### Wrenches

#### Heavy-Duty Straight Pipe Wrenches

- *Sturdy, cast iron housing & I-beam hand with full floating forged hook jaw, nonstick adjustment nut & replaceable hook & heel jaws*



Part #	Mfg #	Model	Nom Size	Pipe Capacity	Price
17378	31000	6	6"	3/4"	14.95
17379	31005	8	6"	1"	17.45
17380	31010	10	10"	1-1/2"	23.05
17381	31015	12	12"	2"	26.60
17382	31020	14	14"	2"	29.80
17383	31025	18	18"	2-1/2"	43.05
17384	31030	24	24"	3"	68.15
17385	31035	36	36"	5"	145.45
17386	31040	48	48"	6"	219.25

#### Heavy-Duty RapidGrip™ Pipe Wrench

- *1-Handed adjustment*
- *Rapid ratcheting action*
- *Aggressive tooth design for secure grip*
- *Thumb trigger for easy application & removal*



Part #	Mfg #	Model	Nom Size	Pipe Capacity	Price
213962	97837	12	12"	2"	25.00

#### Heavy-Duty End Pipe Wrenches

- *Assures a fast & easy grip for pipe working in restricted spaces or close to a wall*



Part #	Mfg #	Model	Nom Size	Pipe Capacity	Price
17387	31050	E-6	6"	3/4"	17.70
17388	31055	E-8	8"	1"	20.55
17389	31060	E-10	10"	1-1/2"	27.35
17390	31065	E-12	12"	2"	31.85
17391	31070	E-14	14"	2"	36.35
17392	31075	E-18	18"	2-1/2"	52.00
17393	31080	E-24	24"	3"	81.85

#### Heavy-Duty Offset Pipe Wrenches

- *Features a jaw opening parallel to the handle & a narrower hook jaw head which provides easy entry into tight spots*



Part #	Mfg #	Model	Nom Size	Pipe Capacity	Price
33294	89435	14	14"	2"	51.60

Prices & specifications are subject to change.



## Tools



### Compound Leverage Wrench

- Unique design multiplies the turning force applied to a pipe
- Ideal for freeing locked couplings & joints frozen by age or damage
- Replaceable jaws are hardened alloy steel



Tools

Part #	Mfg #	Model	Pipe Capacity	Price
111827	31375	S-2	2"	345.70
117953	31380	S-4A	5"	504.95

### Aluminum Handle Straight Pipe Wrenches

- Nearly 40% lighter than comparable cast iron models of the same size
- Jaws & all other parts identical to RIDGID heavy-duty wrenches



Part #	Mfg #	Model	Nom Size	Pipe Capacity	Price
17500	31090	810	10"	1-1/2"	36.70
34151	47057	812	12"	2"	43.95
17501	31095	814	14"	2"	49.85
17502	31100	818	18"	2-1/2"	62.15
17503	31105	824	24"	3"	99.25
17504	31110	836	36"	5"	170.75
53023	31115	848	48"	6"	336.40

### Aluminum Handle Offset Pipe Wrenches

- Nearly 50% lighter than comparable cast iron models of the same size
- Features a jaw opening parallel to the handle & narrower hook jaw head which provides easy entry into tight spots



Part #	Mfg #	Model	Nom Size	Pipe Capacity	Price
57038	31120	14	14"	2"	64.15
57039	31125	18	18"	2-1/2"	87.30
57040	31130	24	24"	3"	134.10

### Chain Wrenches

- A double jaw gives fast, ratchet-like action in either direction
- The heavy-duty has replaceable alloy steel jaws
- The light-duty has a 1-piece forged alloy steel handle & jaw
- Ideal for use in close quarters



Part #	Mfg #	Model	Finish	Rated Pipe Capacity	Actual OD Capacity	Chain Length	Price
17394	31315	C-14	Heavy-Duty	2"	5"	18-1/2"	62.45
17395	31320	C-18	Heavy-Duty	2-1/2"	5"	20-1/4"	93.35
207870	31325	C-24	Heavy-Duty	3"	5"	20-1/4"	108.35
36401	31330	C-36	Heavy-Duty	4-1/2"	7-1/2"	29"	222.40

Prices & specifications are subject to change.

Metropolitan Pipe offers Vendor Managed Inventory - never run out of that part again!



## Tools

Tools

### Strap Wrenches

- Best for any polished pipe
- Strong, woven nylon strap gives tight grip
- Polyurethane-coated strap prevents scratching
- Replacement straps available



Part #	Mfg #	Model	Handle Length	Strap Length	Strap Width	Pipe Capacity	OD Tube Capacity	Price
17396	31340	2	11-3/4"	17"	1-1/8"	2"	3-1/2"	32.60
44146	31345	2	11-3/4"	30"	1-1/8"	2"	5-1/2"	37.40
17397	31360	5	18"	29-1/4"	1-3/4"	5"	7"	65.45
117954	31365	5	18"	48"	1-3/4"	5"	12"	78.60

### Replacement Strap

Part #	Mfg #	Strap Length	Strap Width	Price
17611	32015	17"	1-1/8"	12.95
17612	32050	29-1/4"	1-3/4"	31.00

### Hex Wrenches

- Gives multi-sided, secure grip on all hex nuts, square nuts, unions, & valve packing nuts



Straight

Offset

Part #	Mfg #	Model	Description	Nom Size	Pipe Capacity	Price
17408	31305	E110	Offset Hex	9-1/2"	1-1/8" - 2-5/8"	33.20
142444	31275	17	Straight Hex	14-1/2"	5/8" - 1-1/4"	56.65
17498	31280	25	Straight Hex	20"	1" - 2"	87.00

### Spud Wrench

- Narrow jaws to fit into tight places
- Smooth, toothless jaws ideal for square or rectangular stock



Part #	Mfg #	Size	Pipe Capacity	Price
17407	31400	12"	3/8" - 2-5/8"	39.90

### Internal Wrench

- Holds closet spuds & bath, basin & sink strainers through 2"
- Use to install or extract 1" - 2" nipples
- Jaws expand by eccentric action & are reversible for various sizes



Part #	Mfg #	Model	Length	Pipe Capacity	Price
17400	31405	342	4-1/2"	1" - 2"	70.65

### Basin Wrenches

- Spring-loaded jaws of forged alloy steel
- Tension plug holds head in any position up to 90° angle



Part #	Mfg #	Model	Nom Size	Pipe Capacity	Price
17398	31175	1017	Telescoping 10" - 17"	3/8" - 1-1/4"	35.40
17399	31180	1019	Telescoping 10" - 17"	1-1/4" - 2-1/2"	40.85



## Tools



### Plastic Nut Basin Wrench

- Designed to reach & turn plastic mounting nuts on faucets, sprayers & ball cocks
- Notched ends are designed to self-center on 2, 3, 4 & 6 tab nuts & to fit on metal hex nuts
- Made of 16 gauge cold rolled steel & features a 1-piece 11" steel body for both residential & longer commercial faucet water supply shanks



Tools

Part #	Mfg #	Model	Length	Price
136071	66807	2001	11"	23.80

### OneStop™ Wrench

- (2) Tools in one
- Provides all exact size surface wrenches needed for angle stop & compression coupling installation



Part #	Mfg #	Description	Price
217847	97452	OneStop™ Wrench	25.30

### Wrench Parts

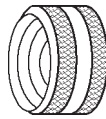

31570

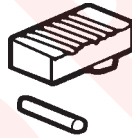

31635

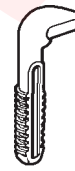

31720



31730

Part #	Mfg #	Description	For Model	Price
17576	31555	Hook Jaw	6, E-6	9.95
17577	31560	Heel Jaw & Pin Assembly	6, 8, E-6, E-8	4.60
17579	31570	Nut	6, E-6	2.90
17580	31580	Hook Jaw	8, E-8	9.95
17581	31585	Heel Jaw & Pin Assembly	810, E-10	5.65
17582	31595	Pipe Wrench Nut	8, E-8	3.05
17584	31605	Hook Jaw	Rapwrench, 10, 810, E-10	12.85
17585	31610	Heel Jaw & Pin Assembly	Rapwrench, 10, 12, 812, E-12	7.45
17586	31615	Nut	Rapwrench, 10, 810, 810CP, E-10, E-110	3.15
17587	31620	Coil & Flat Springs	Rapwrench, 10, 810, 810CP, E-10	3.35
17588	31625	Pin	Rapwrench, 10, 810, BC-210, BC-210-P, E-10	1.55
17590	31635	Heel Jaw & Pin Assembly	14, 16, 814, E-14, S2	9.55
17591	31640	Coil & Flat Springs	12, 812, E-12	3.65
17592	31645	Nut	12, 812, E-12	3.65
17593	31650	Pin	12, 14, 16, 450, 460, 560, 640, 812, 814, 814CP, BC-410, BC-410-P, BC-510, E-12, E-14, S2	1.55
17594	31655	Hook Jaw	14, 16, 814, E-14, S2	17.55
17596	31665	Nut	14, 16, 814, 814CP, E-14, S2	4.15
17597	31670	Hook Jaw	18, 818, E-18	24.65
17598	31675	Heel Jaw & Pin Assembly	18, 818, E-18, S4A	12.85
17599	31680	Coil & Flat Springs	18, 818, 818CP, E-18	7.45
17600	31685	Nut	17, 18, 818, 818CP, E-18	6.10
17601	31690	Pin	18, 818, E-18	1.55
17602	31695	Hook Jaw	24, 824, E-24	38.45
17604	31705	Coil & Flat Springs	24, 842, E-24	8.35

Prices & specifications are subject to change.

Our faucet parts counter is one of the largest in the Boston area with thousands of parts in stock!



**Tools**

**Wrenches (Continued)**

**Wrench Parts**

Part #	Mfg #	Description	For Model	Price
17605	31710	Nut for Wrench	24, 25, 824, E-24	9.00
17606	31715	Pin	24, 824, BC-610, BC-810, E-24	1.55
44513	31725	Heel Jaw & Pin Assembly	36, 836, E-36, S4A	32.85
17607	31730	Pipe Wrench Coil	36, 836, E-36, S4A	10.75
17608	31735	Nut	36, 836, E-36, S4A	16.55
17609	31740	Pin	36, 836, E-36, S4A	1.55
17610	31755	Coil & Flat Springs	48, 848, S6A	12.85
163024	32715	Jaw Assembly	1010, 1017	24.80
17616	32745	Coil Spring, 2/Pk	1010, 1017, 1019	1.65
17618	32760	Groove Pin, 2/Pk	1010, 1017, 1019	2.75

**Tubing Cutters**

**IMP Style - Close Quarters Tubing Cutters**

- Use in restricted spaces on small diameter, hard & soft copper, aluminum, brass & plastic tubing
- Large knurled feed screw knob



Part #	Mfg #	Model	Capacity	Description	Std Wheel	Price
17470	40617	101	1/4" - 1-1/8"	Cutter with Spare Wheel	E-3469	21.95
17471	32975	103	1/8" - 5/8"	Cutter	E-3469	13.25
17472	32985	104	3/16" - 15/16"	Cutter	E-3469	15.45
195564	86127	118	1/4" - 1-1/8"	Quick-Feed Cutter	E-3469	27.40

**Constant Swing Cutters with New X-CEL**

- Features an enclosed feed screw to eliminate clogging & jamming, grooved rolls for close-to-flare cuts, & a fold-away reamer
- Made from high-strength aluminum alloy



Part #	Mfg #	Model	Capacity	Description	Std Wheel	Price
17473	31622	150	1/8" - 1-1/8"	Feed Cutter	E-3469	28.45

**Enclosed Feed Cutters**

- Cuts copper, brass & aluminum tubing & thin-wall conduit
- Quick-acting mechanism for faster size adjustments
- Spare cutter wheel



Part #	Mfg #	Model	Capacity	Description	Std Wheel	Price
17477	33055	205	1/4" - 2-3/8"	Enclosed Feed Cutter	E-3469	76.35

Prices & specifications are subject to change.



## Tools



### Tubing & Conduit Cutters with New X-CEL

- Clean, square cuts on copper, brass, aluminum, & thin-wall conduit



Part #	Mfg #	Model	Pipe Capacity	Description	Std Wheel	Price
17465	32910	10	1/8" - 1"	Screw Feed Cutter	F-158	27.90
17466	32920	15	3/16" - 1-1/8"	Screw Feed Cutter, Fold-Away Reamer	F-158	32.55
91972	32925	15	3/16" - 1-1/8"	Screw Feed Cutter, Fold-Away Reamer, HD Wheel	E-1240	33.85
17467	32930	20	5/8" - 2-1/8"	Screw Feed Cutter, Fold-Away Reamer	F-158	62.55
119791	32935	20	5/8" - 2-1/8"	Screw Feed Cutter, Fold-Away Reamer, HD Wheel	E-1240	64.20
17468	32940	30	1" - 3-1/8"	Screw Feed Cutter for Lg Dia Steel & SS Tubing	F-158	96.80

### Quick-Acting Tubing Cutters with New X-CEL

- I-Beam construction, hardened wear surfaces & bearing side assemblies for smooth operation
- Plastic cutters include spare cutting wheel for cutting copper



Part #	Mfg #	Model	Pipe Capacity	Description	Std Wheel	Price
17479	31632	151	1/4" - 1-5/8"	Quick-Acting, Includes Fold-Away Reamer	E-3469	47.45
17481	31642	152	1/4" - 2-5/8"	Quick-Acting, Includes Fold-Away Reamer	E-3469	76.50
17483	31647	152P	1/4" - 2"	Quick-Acting, Fold-Away Reamer, Wheel for Plastic	E-2155	85.65
17469	31652	154	1-7/8" - 4-1/2"	Quick-Acting Tubing Cutter	E-2558	117.05
17484	31657	154P	1-1/2" - 4"	Quick-Acting Tubing Cutter, Wheel for Plastic	E-2156	123.75
92185	31662	156	4 - 6-5/8"	Quick-Acting Tubing Cutter	E-2558	146.70

### Internal Tubing Cutters

- For trimming tubing below floor level for shower & floor drain installations, or above the ceiling for sprinkler head installations



Part #	Mfg #	Model	Capacity Nom / Depth	Description	Std Wheel	Price
17474	33005	106	2" - 3" / 1/4" - 2-5/8"	Internal, Steel & Aluminum Body	E-2558	220.65
17475	83240	108	1-1/4" - 2" / 1/4" - 1-3/4"	Internal, Cast Iron Body	E-2558	142.35

### Plastic Pipe Tubing Cutters

- Designed for quick, clean cuts through plastic pipe and tube



Part #	Mfg #	Model	Capacity	Description	Std Blade	Price
17487	91125	138	1/8" - 1-1/2" OD	Ratchet Plastic Pipe Cutter	92170	67.25
17488	12831	1493	1/8" - 2-3/8" OD	Ratchet Plastic Pipe Cutter	22086	133.70
894747	23498	RC-1625	1/2" - 1-5/8"	Ratchet Action Plastic Pipe & Tubing Cutter	27858	58.45

Prices & specifications are subject to change.

Our office hours are 7am to 4:30pm and counter hours 6am to 4:30pm Monday through Friday.



## Tools

### Cutter Replacement Blades

Part #	Mfg #	Model	Description	Price
42199	22086	1493	Replacement Blade with Clip	47.80
17704	92170	138	Replacement Blade for 91125	37.15

### Tubing Cutter Wheels

Part #	Mfg #	Model	Blade Exp	Application	For Model	Price
17625	33165	E-1240	.162	Steel - SS	10, 15, 15-SI	7.25
17701	74720	E-2155	.286	PE, PB, PP, Std & Heavy Wall	151-P, 152-P, 153-P	12.25
17702	74730	E-2156	.412	PE, PB, PP, Std & Heavy Wall	30P-133P, 156, 156-P	14.95
17627	33175	E-2191	.292	HD Steel Tubing	30, 40, 122, 122XL, 133, 154, 156	10.00
17626	33170	E-2558	.220	Aluminum & Copper	30, 40, 108, 109P, 133 154, 156	7.70
17630	33190	E-4546	.162	Steel - SS	151, 152, 153, 205	7.85
17629	33185	E-3469	.149	Copper, Aluminum, Brass & Plastic	101, 103, 104, 117, 118, 150, 151, 152, 153, 205	6.25
17628	33180	E-5299	.412	PVC, ABS, Standard Wall	30P - 133P, 106, 108, 109P, 154-P, 156-P	10.70
17624	33160	F-158	.149	Aluminum & Copper	10,15, 20	6.25

### Tubing Cutter Parts

Part #	Mfg #	Description	For Model	Price
17642	34300	Roll Housing Screw, 5/Pk	10	4.35
17662	34830	Rolls, 5/Pk	10	10.50
17663	34860	Pins, 5/Pk	10	7.25
208583	32162	Retaining Rings, 5/Pk	151, 151-P	3.10
17660	34805	Rolls, 5/Pk	15	14.15
17652	34620	Roll Housing Screw	20	4.35
17661	34825	Rolls, 5/Pk	20	15.80
17644	34345	Screws, 5/Pk	20	8.05
17648	34370	Rolls, 5/Pk	30	15.80
134259	74740	Retainer Rings, 5/Pk	101, 103, 104, 105, 117, 118, 150, 151, 152, 153, 205, Plastic	3.05
17636	33960	Pin 2/Pk	108	2.60
17656	34750	Washer Screw	151, 152, 153, 154, 156	2.85
17614	32147	Pin & Clip	154	16.80
17613	32142	Wheel Pins with Clip, 5/Pk	151-P, 152, 152-P, 152-PVC, 153, 153-P	10.65
17655	32112	Roller Pins, 2/Pk	152, 152-P, 152-PVC, 153, 153-P, 205, 205-P	3.25
17654	34670	Rolls, 4/Pk	152, 152-P, 152-PVC, 153, 153-P, 205, 205-P	15.05
17641	34175	Clip	154 & 156	3.65
17614	32147	Wheel Pin & Clip	154 & 156	16.80

Tools





## Tools



### Pipe Cutters

#### 258 Model Power Pipe Cutters

- Easily cuts by displacing instead of removing pipe material
- No abrasive dust, dangerous sparks, or open flame
- Quickly cuts steel pipe with minimal burr
- Adaptable for beveling



Tools

Part #	Mfg #	Model	Pipe Capacity	Price
17446	50767	258	2-1/2" - 8"	3203.10

#### Power Pipe Cutter Accessories

Part #	Mfg #	Model	Description	Price
117016	66687	--	8-1/2" Heavy-Duty Cutter Wheel Assembly (Includes Wheel, Hub with Pins, & Cover Plate)	396.25
142345	50812	E-258	8-1/2" Heavy-Duty Cutter Wheel	238.65
34148	54397	--	Transport Cart	355.20
135002	60002	258PS	Ball Transfer Pipe Support 2-1/2" - 12"	178.70

#### Heavy-Duty Pipe Cutters

- Fast, clean pipe cutting by hand or power
- Extra-long shank protects adjustment threads, while an extra-large handle is provided for quick, easy adjustment
- Can be converted to 3-wheel cutter by replacing rollers with cutter wheel

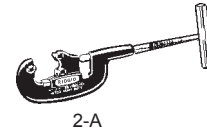

Part #	Mfg #	Model	Pipe Capacity	Description	Price
17434	32820	2-A	1/8" - 2"	Heavy-Duty	150.80
118167	32825	2-A	1/8" - 2"	2-A Heavy-Duty, 3-Wheel Model for Complete Turns	156.95
17435	32830	3-S	1" - 3"	Heavy-Duty	264.30
17436	32840	4-S	2" - 4"	Heavy-Duty	391.95
17437	32850	6-S	4" - 6"	Heavy-Duty	574.75

#### 4-Wheel Pipe Cutters

- Designed for work in areas where a complete turn is impossible



Part #	Mfg #	Model	Pipe Capacity	Description	Price
17438	32870	42-A	3/4" - 2"	4-Wheel HD with Short Handle for 130° Turns	170.45
17439	32880	44-S	2-1/2" - 4"	4-Wheel HD with (2) Handles	456.65

#### Wide Roll Pipe Cutter

- Features extra-wide rolls
- Designed for use with power drives



Part #	Mfg #	Model	Pipe Capacity	Price
47323	32895	202	1/8" - 2"	178.50

Prices & specifications are subject to change.

You can check stock availability, pricing and place orders online at [www.MetPipe.com](http://www.MetPipe.com).



## Tools

Tools

### Hinged Pipe Cutters

- All cutter operate with minimal cutter rotation for tight quarters



Part #	Mfg #	Model	Pipe Capacity	Description	Price
143072	83080	466-S	4" - 6"	For Steel Pipe, X-tra™ Sharp Wheel*	827.75

\* X-tra sharp wheels provide 40% faster cutting

### Pipe Cutter Replacement Wheels

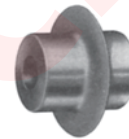

Part #	Mfg #	Model	Blade Exp	Application	For Model	Price
46704	44185	E-1032	.450	Steel & Ductile Iron	202, 360, 732, 820/364	20.20
177371	44190	E-1032S	.450	Stainless Steel Pipe	202, 360, 732, 820/364	28.55
241648	33135	E-1962	.265	Grey Cast Iron	3S, 4S, 44S, 466C/S/HWS, 468C/S/HWS, 472C/S/HWS	17.95
784024	83140	E-3186	.680	Steel & Ductile Iron	466C/S/HWS, 468C/S/HWS, 472C/S/HWS	33.25
17620	33105	F-3	.312	Steel & Ductile Iron	1A, 2A, 42A, 202, 360, 732, 820/364	11.25
155968	33110	F-3S	.312	Stainless Steel Pipe	1A, 2A, 42A, 202, 360, 732, 820/364	11.75
887409	33115	F-119	.132	Grey Cast Iron	1A, 2A, 42A, 202, 360, 732, 820/364	9.05
17622	33125	F-229	.411	Steel & Ductile Iron	3S, 4S, 44S, 466C/S/HWS, 468C/S/HWS, 472C/S/HWS, 764	17.95
133954	33130	F-229S	.411	Stainless Steel Pipe	3S, 4S, 44S, 466C/S/HWS, 468C/S/HWS, 472C/S/HWS, 764	19.80
17623	33145	F-367	.470	Steel & Ductile Iron	6S, 208, 209	19.65
146112	33150	F-367S	.470	Stainless Steel Pipe	6S, 208, 209	20.00
17619	33100	F-514	.312	Steel & Ductile Iron	1A, 2A, 42A, 202, 360, 732, 820/364	8.95
17621	33120	F-515	.411	Steel & Ductile Iron	3S, 4S, 44S, 466C/S/HWS, 468C/S/HWS, 472C/S/HWS, 764	14.30

### Soil Pipe Cutters

- Provides 1-stroke cutting of 1-1/2" to 6" service weight, No-Hub® soil pipe, clay, asbestos & c



Part #	Mfg #	Model	Pipe Capacity	Description	Price
17490	68650	206	1-1/2" - 6"	Cuts No Hub® Soil Pipe	563.25
163877	69982	226	1-1/2" - 6"	In-Place, Cuts Hub and No-Hub Soil Pipe, 17" Long	541.20
17489	32900	246	1-1/2" - 6"	Cuts Clay, Cast Iron, Cement Pipe, 4" Class 22 Water Main	583.80
17491	32905	228	1-1/2" - 8"	Soil Pipe Assembly Tool	582.15

Prices & specifications are subject to change.



## Tools



### Press Snap Soil Pipe Cutter - for Ridgid Press Tools

- The Press Snap™ Soil Pipe Cutter expands the capabilities of RIDGID® standard press tools by providing a fast and easy way to cut cast iron soil pipe. Without lengthy lever arms used by traditional soil pipe cutters, improved access is a snap.
- The Press Snap cutter works with all RIDGID standard press tools (CT-400, 320-E, RP 330-B and RP 330-C) to cut most 1-1/2" – 4" soil pipe in seconds. Simply connect the Press Snap cutter to a RIDGID press tool, wrap the chain around the pipe, and press. No manual ratcheting or additional tools are required. Cutting soil pipe has never been so easy!



Tools

Part #	Mfg #	Model	Pipe Capacity	Description	Price
921519	34403	34403	1-1/2" - 4"	Attaches to Ridgid pressing tools to snap cut No-Hub & SV Pipe	472.50

### Soil Pipe Cutter Chains

Part #	Mfg #	Description	Price
152394	34575	Replacement Chain Assembly for Model 246	286.20
17650	34570	Chain Extension Assembly for 246	49.20
152398	33670	Replacement Chain Assembly for Model 206, 226, 276	269.70
17635	33665	Chain Extension Assembly for 206, 226, 276	38.70

### Pipe Tools Pipe Reamers

- All reamers include handles



Part #	Mfg #	Model	Capacity	Description	Price
17431	34955	2-S	1-1/4" - 2"	Self-Feeding Spiral Ratchet Not Suitable for Power Drive Reaming	234.75
881655	34950	3	3/8" - 3"	Straight Ratchet	379.75
17432	34960	254	2-1/2" - 4"	Hollow Center Spiral Ratchet	418.40

### Replacement Cones (Reamer Cores)

Part #	Mfg #	Model	Description	Price
881655	34950	3	Reamer Core Only	379.75

### Inner-Outer Reamer

- Plastic construction with long-wearing alloy steel blades



Part #	Mfg #	Model	Capacity	Construction	Price
37113	34965	127	1/4 - 1-1/2" Nominal Water Tube	Plastic	21.50

Prices & specifications are subject to change.

We offer a variety of GREEN products such as flush valves, faucets, showerheads & more!



## Tools

Tools

### Stainless Steel Inner/Outer Reamer

- Integrated measurement tool allows you to easily measure pipe size.
- 227S features 45 cutting edges on the Inner and Outer cone allowing for fast, clean Inner reaming and Outer deburring. The 223S features 36 cutting edges.



Part #	Mfg #	Model	Capacity	Construction	Price
924169	29983	223S	1-4" - 1-1/4"	Stainless Steel	35.85
924170	29993	227S	1/2" - 2"	Stainless Steel	61.45

### Deburring Tools

- For plastic pipe & tubing
- Made of high-grade steel with long-lasting cutting edges
- Ideal for removing outside ridges & inside burrs on plastic pipe & tubing



Part #	Mfg #	Model	Plastic Capacity	Plastic Tubing Cap ID	Price
17499	35155	72	1/2" - 1-1/2"	3/4" - 2-1/8"	20.35
184323	64962	73	1-1/2" - 3"	--	26.50
187310	64967	74	4"	--	32.10

### Tubing Tools

#### 300 Series Lever Benders

- Designed to bend copper tubing to a maximum of 180°
- Offset cushion grip handles, 90° start angle
- Form smooth bends in types K & L soft (annealed) copper tubing



Part #	Mfg #	Model	Capacity Tube Size Actual OD	Capacity Bend Radius	Price
17510	36962	310	5/8"	2-1/4"	121.05

#### 400 Series Instrument Lever Benders

- Combines accuracy with ease of operation
- Offset cushion grip handles
- 90° Start angle, oil-absorbing shoe
- Forms bends in copper, steel and stainless steel tubing



Part #	Mfg #	Model	Capacity Tube Size Actual OD	Capacity Bend Radius	Price
17511	36122	404	1/4"	5/8"	60.85
889640	36092	405	5/16"	15/16"	74.00
17512	36097	406	3/8"	15/16"	65.80
17513	36132	408	1/2"	1-1/2"	111.85

Prices & specifications are subject to change.



## Tools



Tools

### 456 Tri-Bender

- Ideal for plumbing & HVAC applications
- 90° Start angle minimizes effort required to form a bend
- Handy reference marks indicate the angle for quick bends through 90°



Part #	Mfg #	Model	Capacity	Price
17514	44852	456	1/4", 5/16", 3/8"	39.65

### Geared Ratchet Lever Tube Bender

- Bends heavy-wall steel tube (up to 1/8" wall thickness), stainless steel tube (up to 3/32" wall thickness), & hard copper water tube (types K & L)
- Benders produce uniform bends up to 180° with no need to anneal tubing or use special temper grade tubing

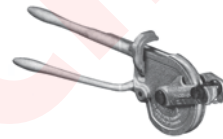

Part #	Mfg #	Model	Radius	Tube OD	Price
119793	35170	358	3"	5/8"	313.15
172883	35180	378	3-3/4"	7/8"	423.55

### Spring-Type Tube Benders

- Fast, free-form bending of soft copper and aluminum tube



Part #	Mfg #	Model	Length	Tube OD	Price
17515	35245	D-1375	10"	1/4"	23.80
17516	35255	D-1377	10"	3/8"	30.15
17517	35265	D-1379	12"	1/2"	34.20
185910	35270	D-1380	12"	5/8"	34.20
185911	35275	D-1381	12"	3/4"	42.90

### Ratchet Flaring Tool

- Ratcheting feed screw handle
- Hardened steel flaring cone, eccentrically mounted in needle bearings



Part #	Mfg #	Model	Type	Sizes	Price
17478	83037	458R	45° SAE Flares	1/8", 3/16", 1/4", 5/16", 3/8", 1/2", 5/8", 3/4"	139.00

### Flaring Tools

- Precision designed tool for producing 45° flares in soft copper, brass, aluminum, & mild steel (JIC & Bundy) tubing
- A hardened, smooth cone provides fast, 45° flares either single or double lap
- A single clamp screw provides for easy clamping & removal of tubing



Part #	Mfg #	Model	Type	Sizes	Price
17401	23332	345	45° SAE Flares	3/16", 1/4", 5/16", 3/8", 7/16", 1/2", 5/8"	51.40

Prices & specifications are subject to change.

Our state of the art pipe shop offers cutting, threading, grooving and make-ons up to 36in!



## Tools

### Hammer-Type Flaring Tools

- Made of high-grade hardened steel
- Long nose guide that centers tools for smooth, 45° uniform flares



Part #	Mfg #	Model	Water Tube Size	Price
34149	41330	E-47	3/4"	15.35
34150	41335	E-52	1"	19.35

### Pipe Vises & Supports Portable Tristand® Vises

- Foldable integral legs and tray



Part #	Mfg #	Model	Pipe Capacity	Description	Price
162359	72037	460 +	1/8" - 6"	Portable Tristand Chain Vise	480.95

+ Jaw for plastic pipe, catalog # 41280 available; order separately

### Pipe Welding Vises

- Designed to resist strain, heat and warpage during tacking
- Machined swivel nuts and pins



Part #	Mfg #	Model	Pipe Capacity	Description	Price
17441	40220	461	1/2" - 8"	Straight Pipe Welding	166.25

### Bench Chain Vises

- Crank handle is anchored
- Cast iron base with pipe rest and bender



Part #	Mfg #	Model	Pipe Capacity	Description	Price
44140	40195	BC410	1/8" - 4"	Top Screw Bench Chain Vise	213.90

Tools



## Tools



### Bench Yoke Vises



Tools

Part #	Mfg #	Model	Pipe Capacity	Price
43849	40080	21	1/8" - 2"	175.50
182693	40090	23	1/8" - 3"	257.80
177102	40100	25	1/8" - 4"	299.95
890493	40110	27	1/8" - 6"	607.15

### Portable Chain and Yoke Vises

- Light, strong, portable post chain vise
- Fits any shape or kind of post
- Model 640 features a pipe bender and tray for oil can
- Portable yoke vise attaches to plank, workbench or post



Part #	Mfg #	Model	Pipe Capacity	Description	Price
889080	40125	39	1/8" - 2-1/2"	Portable Kit Yoke Vise	279.75
17440	40170	640	1/8" - 5"	Top Screw Post Chain Vise	302.25

### Vise Parts

Part #	Mfg #	Description	For Model	Price
17680	41020	Vise Jaw	425, 450, 460, 560, 640, BC-410, BC-4A, BC-510	61.95
17681	41050	Handle with Nut	425, 450, 460, 560, 640, BC-410, BC-510	39.75
865936	92615	Screws with Washers, 5/Pk	BC210	4.05

### Pipe Stands

- Heavy-duty adjustable pipe stands are available in varying configurations with capacity from 1/8" - 36"
- Suitable for use with threading machines, roll groovers, etc

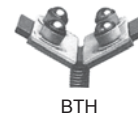

Part #	Mfg #	Model	Description	Height Adjustment Range	Max Pipe Capacity	Max Weight Capacity	Price
115251	56657	VJ-98	V Head Low	20" - 38"	12"	2500 lbs	78.90
17462	56662	VJ-99	V Head High	28" - 52"	12"	2500 lbs	79.50
115252	37997	BTH-9	Ball Transfer Head for VJ	-	12"	1000 lbs	137.95

### Adjustable Pipe Supports

Part #	Mfg #	Model	Description	Height Adjustment Range	Max Pipe Capacity	Max Weight Capacity	Price
17453	42505	46	Adjustable Pipe Support	23" - 33"	6"	2500 lbs	310.25

Prices & specifications are subject to change.

Metropolitan Pipe offers FREE DELIVERY in the Greater Boston area.



## Tools

Tools

### Manual Threaders Manual Ratchet Threader Sets

- All matched threader sets include die heads, ratchet assembly, ratchet handle and allow dies (use same 12-R dies in die head)



Part #	Mfg #	Model	Capacity	Description	Price
17420	36475	12-R	1/2" - 2"	NPT Exposed Ratchet Threader Set	727.40

### Ratchet & Handle Only

- Ratchet knob indicates forward and reverse
- Die heads snap in from both sides and lock in place



Part #	Mfg #	Model	Price
17416	38540	00-RB	68.50
17417	38550	111-R	83.40
17418	38555	12-R	83.40

### Die Heads - Manual Threaders

- Complete with dies
- North American standards



Part #	Mfg #	Model	Pipe Capacity	Description	Price
17411	36880	00-R	1/4"	Alloy RH	71.10
17412	36885	00-R	3/8"	Alloy RH	71.10
17413	36890	00-R	1/2"	Alloy RH	70.85
17414	36895	00-R	3/4"	Alloy RH	70.85
17415	36900	00-R	1"	Alloy RH	76.30
883519	37385	12-R	3/8"	Alloy RH	90.50
17421	37470	12-R	1/4"	High Speed RH	98.75
17423	37480	12-R	1/2"	High Speed RH	105.70
17424	37485	12-R	3/4"	High Speed RH	105.70
17425	37490	12-R	1"	High Speed RH	132.95
17426	37495	12-R	1-1/4"	High Speed RH	132.95
17427	37500	12-R	1-1/2"	High Speed RH	156.50
17428	37505	12-R	2"	High Speed RH	156.50
890393	37620	00-RB	3/8"	Alloy RH UNC	54.80

### Pipe Dies - National Pipe Taper NPT

- Fits 0-R, 00-R, 11-R, 12-R, 30A, 31A



Part #	Mfg #	Pipe Capacity / TPI	Description	Price
17664	37810	1/8" - 27	Alloy RH	47.90
17665	37815	1/4" - 18	Alloy RH	47.90
17666	37820	3/8" - 18	Alloy RH	47.00
872105	37825	1/2" - 14	Alloy RH	46.75
50083	37840	1-1/4" - 11-1/2	Alloy RH	56.85

Prices & specifications are subject to change.





**Manual Threaders (Continued)**  
**Pipe Dies - National Pipe Taper NPT**

Tools

Part #	Mfg #	Pipe Capacity / TPI	Description	Price
17667	37870	1/2" - 14	High Speed RH	53.10
17668	37875	3/4" - 14	High Speed RH	53.10
17669	37880	1" - 11-1/2	High Speed RH	63.05
17670	37885	1-1/4" - 11-1/2	High Speed RH	63.05
17671	37890	1-1/2" - 11-1/2	High Speed RH	78.15
17672	37895	2" - 11-1/2	High Speed RH	78.15
92086	38120	2-1/2" - 4	High Speed RH	325.55
39708	37915	1/2" - 14	High Speed SS RH	67.65
39710	37920	3/4" - 14	High Speed SS RH	67.65
39712	37925	1" - 11-1/2	High Speed SS RH	67.65
39715	37935	1-1/2" - 11-1/2	High Speed SS RH	84.00
39716	37940	2" - 11-1/2	High Speed SS RH	84.00
48444	70695	3/4" - 14	High Speed PVC RH	61.10
48445	70700	1" - 11-1/2	High Speed PVC RH	71.25
47394	70710	1-1/2" - 11-1/2	High Speed PVC RH	90.75

**Die Set Metal Carrying Case**

- Steel case with rust-resistant finish to keep die sets together



Part #	Mfg #	Description	Threader Type	Weight	Price
142745	38605	Metal Case	00-R	7-1/2 lbs	80.60
53772	38625	Metal Case Holds 6 Die Heads	12-R	13 lbs	136.05

CELEBRATING  
**75** YEARS  
 1934 • 2010

Metropolitan Pipe recently celebrated 75 years of operation. Our staff, with over a century of combined experience, is always ready to tackle your next job. No one knows the industry better!



## Tools

### Power Threading Equipment 600 Model Hand-held Power Threader

- Reversible 115V motor
- CSA, CSA & UL Approved



Part #	Mfg #	Model	Description	Price
17449	36912	600	115V 1/2" - 1-1/4" NPT Capacity with Case & Support Arm	1305.45

### 700 Model Heavy-Duty Hand-Held Power Threader

- Reversible 115V motor
- CSA, CSA & UL Approved

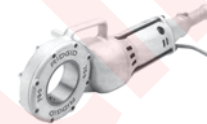

Part #	Mfg #	Model	Motor	Pipe Capacity	Rod Capacity	Max Geared Threader Cap	Price
17450	41935	700	115V	1/8" - 2"	1/4" - 1"	6"	1520.30

### 300 Model Power Drive Complete for Portable Threading

- Convert your 300 Power Drive into a portable threading machine
- Standard Equipment:
  - Die heads & dies for use with 300 Power Drive with 311 carriage
  - (1) Model 360 cutter
  - (1) Model 341 reamer
  - (1) Model 311 carriage with lever
  - (1) Model 1206 stand
  - (1) Model 1452 clip-on tool tray
  - (1) Model 418 oiler with 1 gal Nu-Clear threading oil
  - (1) Model 32 transporter



Part #	Mfg #	Model	Spindle Speed	Pipe Capacity	Rod Capacity	Max Geared Threader Cap	Price
17445	15682	300 Complete	38 rpm	1/8" - 2"	1/4" - 2"	6"	4370.60

### Oil-Less Threading Machine Parts & Accessories

Part #	Mfg #	Model	Description	Price
48260	36620	141	4" Geared Threader NPT	2393.50
17458	42385	312	Carriage Feed Lever for 300 Power Drive	84.00
143151	42575	32	Transporter for #300	171.05
48263	19366	758	Loop (300) for 141	42.55
158213	67807	--	1/2 - 3/4" NPT Oil-Less Gold Dies, RH	174.00
158216	67827	--	1 qt Thread Cutting Coolant	14.95
158212	67817	610	1/2 - 1" NPT, Quick-Opening Die Heads, RH	341.50
158217	67822	120	Folding Stand	221.80

Tools



## Tools



### Universal Die Heads - Machine NPT

- Use with:
  - 535A Automatic Threading Machine
  - 300 Compact Threading Machine
  - 1822-I Threading Machine
  - 300 Power Drive



Part #	Mfg #	Model	Description	Price
17508	97065	811A	1/8" - 2" NPT, Quick-Opening, Automatic Release, RH Thread Direction	395.75
52716	97075	815A	1/8" - 2" NPT, Self-Opening, Manual Release, RH Thread Direction	507.00

### Pipe Dies for Machine Die Heads

#### Pipe Dies for 504A, 711, 731, 811A, 815A & 842

Part #	Mfg #	Die Material or Type	Nominal Pipe Size	Threads per Inch	Price
17693	47735	Alloy RH NPT	1/8"	27	117.70
17694	47740	Alloy RH NPT	1/4"-3/8"	18	117.70
17695	47745	Alloy RH NPT	1/2"-3/4"	14	117.70
17696	47750	Alloy RH NPT	1"-2"	11-1/2	117.70
17697	47765	High-Speed RH NPT	1/2"-3/4"	14	176.45
17698	47770	High-Speed RH NPT	1"-2"	11-1/2	176.45
17699	47785	High-Speed for SS NPT	1/2"-3/4"	14	176.45
17700	47790	High-Speed for SS NPT	1"-2"	11-1/2	176.45

### 819 Nipple Chuck Kit

- Holds short or close nipples, studs for threading
- For use with 300 Power Drive, 300 Compact, 535 and 1822 (with adapter kit) and 1224 Threading Machines
- Standard nipple chuck includes insert and (5) adapters



Part #	Mfg #	Description	Price
17455	51005	1/2" - 2" NPT Nipple Chuck Kit	397.65
112049	51020	Nipple Chuck Wrench	4.00

### Threading Equipment Parts & Accessories

Part #	Mfg #	Model	Description	Price	
56790	32475	E-6085	Portable Power Drive Spring Pins 2/Pk	4.90	
134734	36642	B-294	Foot Switch	215.15	
42987	42620	774	Square Drive Adapter	106.80	
17451	42950	B-171-X	Metal Carrying Case for #700 & Accessories	157.40	
17464	42360	1206	Power Drive Stand for 300 Power Drive, 975, 122XL, 122	357.20	
17505	42365	341	Reamer for #311 Carriage w/Lever	197.40	
17506	42370	360	Cutter for #311 Carriage	209.05	
115594	42405	844	Drive Bar	129.80	
168904	61122	840A	Universal Drive Shaft	473.40	
157855	67662	916	Groover Adapter Bracket	300 Compact, 916	394.60
17507	68815	311	Carriage with #312 Lever	359.45	
52131	44505	--	HD Motor Switch for 300, 535	102.55	
17688	44090	--	Chuck Jaw Set	260.60	

Prices & specifications are subject to change.

Our faucet parts counter is one of the largest in the Boston area with thousands of parts in stock!



**Tools**

**Power Threading Equipment (Continued)**  
**Threading Equipment Parts & Accessories**

Tools

Part #	Mfg #	Model	Description	Price
17690	44715	--	Jaw Inserts, 3/Pk	78.05
17691	45260	--	Pins, 5/Pk	7.15

**Threader Oilers**  
**Oilers**

- Hand-operated, easy pumping 2-finger trigger
- Completely portable, large pan catches oil run-off chips
- Oil is double-filtered & recirculated through reservoir
- Chip pan 14-1/2" diameter, 8-1/2" deep, hose length 54"



Part #	Mfg #	Model	Description	Price
162517	10883	418	Hand-operated Oiler Complete	287.80
165556	72332	418	Hand-operated Oiler Only	138.80
206310	72327	418	Hand-operated Oiler with 54" Hose & Hose Fittings	169.25

**Oiler Parts**

Part #	Mfg #	Description	For Model	Price
135923	41765	Strainer	318, 418	11.65

**Thread Cutting Oil**

- Cools threads & pipe during operation
- Speeds metal removal
- Dark oil - traditional mineral oil with low odor and anti-mist formulation
- Nu-Clear® oil - clear mineral oil with low odor and anti-mist formulation; low temperature properties maintain workable viscosity to -20°F
- Extreme performance oil - high performance mineral oil formulated to produce superior quality threads on stainless steel and black pipe



Part #	Mfg #	Type	Size	Price
140950	41590	Dark	1 qt	10.35
17457	70830	Dark	1 gal	23.55
119719	41565	Nu-Clear®	1 qt	11.05
17456	70835	Nu-Clear®	1 gal	25.60
885397	22088	Extreme Performance	16 oz Aerosol	13.40
198324	74012	Extreme Performance	1 gal	34.55
180398	74022	Water Washable	1 gal	29.85

Prices & specifications are subject to change.



## Tools



### Roll Grooving

#### Roll Groover

- Up to 12" wide capacity range in one unit for service versatility
- Cast-in carrying handle & easy to use depth setting gauge
- 90° Bend-in handle



Tools

Part #	Mfg #	Model	Description	Price
212922	88232	915	Roll Groover w/2" - 6" Sch 10 (2" - 3-1/2" Sch 40) Roll Set	1045.45
17448	45007	916	Roll Groover for 300 Power Drive	1099.80

### Portable Roll Groover

- Ability to groove 6" Sch 10 and 40 steel pipe
- Grooving capacity of 1" to 6" Sch 10 and 40 steel pipe; 2" to 6" copper tube type K, L, M, and DWV steel
- Convenient carrying handle & permanently affixed depth setting gauge
- Heat treated feed screw bushing for added durability
- Feedscrew can be actuated by using either the standard 14" ratchet or any 15/16" hex



Part #	Mfg #	Model	Description	Price
216572	91207	960	1-1/4" - 6" Roll Groover	889.95



## Pipe Fabrication Shop

Cutting, threading, grooving, make-on  
and welding - on site!



## Pliers, Cutters & Strippers

Tools

### PVC Ratchet-Action Tube Cutter

- For cutting Sch 40 material (PVC, CPVC, ABS, vinyl, poly pipe and tubing)
- All metal heavy duty construction & easy-change blades



Part #	Mfg #	Description	Price
160087	73002	Cuts 1/4" to 1" OD Pipe	27.84



### Autocut™ Copper Tubing Cutter



Part #	Mfg #	Description	Price
159445	ATC12	For 1/2" Tubing	19.55
159446	ATC34	For 3/4" Tubing	21.35
808612	ATC100	For 1" Tubing	28.85
159447	ATCW	Replacement Cutter Wheels	4.70

### SuperSlice™ Plastic Tubing Cutter



Part #	Mfg #	Description	Price
168326	SUS	For Up To 1" Plastic Tubing	22.70



### Tubing Cutters Ergonomically Designed for Professional Performance

- Professional deburring
- Will not damage cutting wheel
- Easy to use - change out wheels with only a screwdriver



Part #	Mfg #	Tube Diameter Range	Price
239135	21010-TC11/8	1/8" - 1-1/8"	38.58

### Tubing Cutters (Continued)

Ergonomically Designed  
for Professional Performance

Part #	Mfg #	Tube Diameter Range	Price
239137	21011-TC13/8	1/8" - 1-3/8"	55.60
239139	21012-TC13/4	1/8" - 1-3/4"	83.19
239140	21013-TC25/8	1/4" - 2-5/8"	140.97

### Cutter Wheels



Part #	Mfg #	Description	Price
875112	21191-TCW15	Plastic Wheel, 2/Pk	34.02
865294	21192-TCW15	Copper Wheel, 2/Pk	20.06
865572	21193-TCW15	Stainless Steel Wheel, 2/Pk	20.06



### Glass Cutter

- Cuts glass tube & pipe, as well as other brittle tubular materials
- Small enough to carry in your pocket
- Cuts gauge glass, lab glass & porcelain tube
- Works by wrapping the chain around the tube & hooking the nearest chain ping in the jaw. Then a twist of the wrist & a squeeze of the handle makes the cut



Part #	Mfg #	Description	Price
190007	69012	Cuts 1/4" - 3/4" OD	38.00

### Gauge Glass Cutter



Part #	Mfg #	Description	Price
15315	1801000	Tong-Style Cutter	21.05



## Tools



### Wet/Dry Vacuums - Commercial Series

- Full lifetime warranty against material defects and workmanship
- Proprietary motor and patented blower wheel designed to maximize performance
- Pleated 3-stage filter for greater efficiency & longer life
- Reduced dB level
- Impact & corrosion resistant 2-piece polypropylene drum
- Automatic suction shutoff
- Unit converts to a blower with up to 150 mph blowing velocity
- 20' Cord



Tools

Part #	Mfg #	Model	Capacity	Sealed Pressure	Peak HP	Air Watts	Price
209956	18723	WD1850 - ProVac	16 gal	50"	6.50	290	199.60

### Wet/Dry Vacuum Accessories

Part #	Mfg #	Description	Price
167124	72952	High Efficiency 3-Stage Filter	25.50
860609	26643	High Efficiency Filter with Microban®	16.40

### Pressing Tools

#### RP 330-B Press Tool

- For convenience and portability, the RP 330-B is the logical choice. Featuring a barrel that rotates 270 degrees and a longer service interval, the RP 330-B is designed to handle your toughest construction projects. Powered by a 18V Lithium-Ion Battery, the RP 330-B offers more presses per battery charge than ever before.
- Capacity: 1/2" – 4"
- 270° Barrel/Jaw swivel
- Battery: 18V Li-Ion
- Battery charger: 115V
- Hydraulic ram output: 7,200 lbs. (32kN)
- Weight: 10.0 lbs. w/ battery
- Operating temperature range: 14°F to 122°F
- Approximate cycle time: 5 seconds



Part #	Mfg #	Description	Price
913273	27923	Kit: 1/2" - 2" Jaw Set, Case, 2 Batteries & Battery Charger	3390.10

#### RP 330-C Press Tool

- Want peace of mind from your press tool? The RP 330-C features the same reliability and durability of the RP 330-B with the added confidence a power cord offers. At nearly half the weight of the previous corded unit, this is our lightest corded press tool ever.
- Capacity: 1/2" – 4"
- 270° Barrel/JawsSwivel
- Hydraulic ram output: 7,200 lbs. (32kN)
- Weight: 9 lbs.
- Operating temperature range: 14°F to 122°F
- Approximate cycle time: 5 seconds



Part #	Mfg #	Description	Price
912592	27948	Kit: 1/2" - 2" Jaw Set, Case	2887.70

Prices & specifications are subject to change.

You can check stock availability, pricing and place orders online at [www.MetPipe.com](http://www.MetPipe.com).



**Tools**



Tools

**RP 210-B Press Tool**

- Say "hello" to your little friend! RIDGID® introduces the ultimate in press tool technology: the RP 210-B. For a fast and reliable way to join copper, stainless steel and PEX, the new RP 210-B has more capacity than any compact press tool on the market. This model is 2 inches shorter and 25% lighter than our previous compact tool and features the longest service interval available (32,000 cycles), an improved swiveling barrel and a powerful 18V Lithium-Ion battery. Now you can do more... with less!
- Capacity: 1/2" – 1-1/4" (Copper & Stainless Steel), 3/8" - 1/2" (PEX)
- 270° Barrel/Jaw swivel
- Battery: 18V Li-Ion 1.1Ah
- Weight: 6.4 lbs. with battery
- Battery charger: 115V
- Hydraulic ram output: 5,400 lbs. (24kN)
- Operating temperature range: 15°F to 122°F
- Approximate cycle time: 5 seconds



Part #	Mfg #	Description	Price
918238	31028	Kit: 1/2" - 1-1/4" Jaw Set, Case, 2 Batteries & Battery Charger	2237.10

**Pressing Rings**

**Standard Series XL-C Press Rings**

- For use with ProPress systems; patented
- For use with ProPress XL-C copper fittings
- Works with V2 actuator and provides increased flexibility in tight spaces, swivels nearly 180° with XL-C press rings



Part #	Mfg #	Description	Price
886970	20483	2-1/2" - 4" Pressing Rings, Actuator, & Case	2533.30

**Standard Series XL Press Rings**

- For use with ProPress XL bronze fittings
- Spring-loaded to remain in place
- Works with the R2 actuator on all standard series pressing tools to make connections of 2-1/2" to 4" tube



Part #	Mfg #	Description	Price
233523	93667	2-1/2" - 4" Pressing Rings, Actuator, & Case	2533.30

**Pressing Jaws**

**Standard Series Jaws for ProPress Systems**

- Total system compatibility with the ProPress System fittings
- Compatible only with Ridgid Standard Series pressing tools
- Backed by full Ridgid Lifetime Warranty
- For use with copper



Part #	Mfg #	Description	Price
893683	76652	1/2" Jaw	194.90
893684	76657	3/4" Jaw	194.90
893682	76662	1" Jaw	194.90

Prices & specifications are subject to change.





**Pressing Jaws (Continued)**  
**Standard Series Jaws for ProPress Systems**

Part #	Mfg #	Description	Price
867554	76667	1-1/4" Jaw	194.90
876580	76672	1-1/2" Jaw	249.95
876582	76677	2" Jaw	273.65

**Compact Series Jaws for ProPress Systems**

- 40% Lighter and 33% Smaller than Standard Series Jaws enabling them to fit into tight spaces.
- Compatible only with Ridgid Compact Series Pressing tools

Part #	Mfg #	Description	Price
931676	16958	1/2" Jaw	192.31
931677	16963	3/4" Jaw	192.31
931678	16978	1" Jaw	192.31
931679	31228	1-1/4" Jaw	203.85

**Standard Series Jaws for PureFlow™ Systems**

- Total system compatibility with the PureFlow System fittings
- Compatible only with Ridgid Standard Series pressing tools
- Backed by full Ridgid lifetime warranty
- Compatible with:  
 Viega Pexcel PureFlow Plumbing Systems  
 Viega Radiant Heating Systems  
 Viega Snow Melting Systems



Part #	Mfg #	Description	Price
907936	22653	1/2" Jaw	222.39
907937	22658	5/8" Jaw	222.39
907938	22663	3/4" Jaw	222.39
907939	22668	1" Jaw	222.39
907940	22673	1-1/4" Jaw	228.30
907941	22678	1-1/2" Jaw	291.83

**Compact Series Jaws for PureFlow™ Systems**

- 40% Lighter and 33% Smaller than the Standard Series Jaws
- Compatible only with Ridgid Compact Series pressing tool

Part #	Mfg #	Description	Price
907926	17003	3/8" Jaw	1304.25
907927	17008	1/2" Jaw	165.50
907928	19813	5/8" Jaw	165.50
907929	17013	3/4" Jaw	165.50
907930	17018	1" Jaw	165.50
907934	22683	1-1/4" Jaw	209.09
907935	22688	1-1/2" Jaw	231.25



## Tools



### Press Snap Soil Pipe Cutter - for Ridgid Press Tools

- The Press Snap™ Soil Pipe Cutter expands the capabilities of RIDGID® standard press tools by providing a fast and easy way to cut cast iron soil pipe. Without lengthy lever arms used by traditional soil pipe cutters, improved access is a snap.
- The Press Snap cutter works with all RIDGID standard press tools (CT-400, 320-E, RP 330-B and RP 330-C) to cut most 1-1/2" – 4" soil pipe in seconds. Simply connect the Press Snap cutter to a RIDGID press tool, wrap the chain around the pipe, and press. No manual ratcheting or additional tools are required. Cutting soil pipe has never been so easy!



Tools

Part #	Mfg #	Model	Pipe Capacity	Description	Price
921519	34403	34403	1-1/2" - 4"	Attaches to Ridgid pressing tools to snap cut No-Hub & SV Pipe	472.50





## Tools



### Pipe Freezing & Thawing

#### SuperFreeze™ Pipe Freezing Kit

- Allow contractor to keep water systems operating while making repairs
- 1/2" to 2" Steel pipe, 1/2" to 2-1/2" copper tube capacities
- R-507 Refrigerant (14.2 oz charge)
- 55 lbs, 8-1/2' Hose, 21"L x 10-1/2"W x 13"H
- CSA & UL Approved



Part #	Mfg #	Model	Includes	Price
155576	68967	SF-2500	SuperFreeze™ Kit	3398.80

#### KT-200 Pipe Thawing Kit

- Thaws 1/2" to 1-1/2" frozen metal pipes; 4' to 150' lengths
- Operates on standard 115V, 15A outlet
- Light weight - under 30 lbs
- CSA & UL Approved



Part #	Mfg #	Model	Includes	Price
52202	62747	KT-200	(2) 25' #1/0 Cables	1078.75



#### Cold Shot™ Pipe Freeze Kit

- Includes:
  - (10) Sets of freeze heads for 1/8" to 2" steel, copper, cast iron, lines
  - (2) High pressure spiral hoses with grips and injectors
  - T-Distributors
  - Locking nut
  - Hex head screwdriver
  - Rubber gloves
  - Goggles
  - Carrying case



Part #	Mfg #	Description	Price
178847	CST-2	Kit	535.00

### Hot Shot™ Pipe Thawing Machine

- Thaws frozen pipes quickly
- Attach pipe clamps and plug into 115V receptacle
- (2) 20' #2 Cables with clamps and lugs
- Thermal overload protection
- Weighs 30 lbs
- Generates 320 amps of thawing power, yet draws only 14 amps
- Can thaw 1-1/2" x 100' pipe



Part #	Mfg #	Description	Price
222642	HS320	320A, 15A Circuit Breaker	816.00

Tools

# STORE HOURS

Monday - Friday

6AM - 4:30PM



## Power Drills

Tools

### Corded Power Tools

#### 1/2 in. Hole-Hawg® Drill 300/1200 RPM

- Handles up to 4-5/8 in. self-feed bit
- Two speed: 300 and 1200 rpm, reversing
- Powerful 7.5 amp motor
- Powerful, yet compact for large hole drilling between joists and studs
- Includes pipe handle
- Voltage: 120 AC, Amps: 7.5
- No load RPM: 300/1,200
- Chuck type: keyed
- Wood capacity-auger bit: 1-1/2", self-feed bit: 4-5/8"
- Metal capacity-twist bit: 1/2"
- Chuck size: 1/2"
- Spindle: 5/8 in.-16
- Cord Type: 8 ft. Fixed
- Tool Weight: 11.5 lbs.



Part #	Mfg #	Description	Price
17142	1676-6	1/2 in. Hole-Hawg® Drill	412.50

#### 1/2" Magnum® Drill, 0-850 RPM with All Metal Chuck and QUIK-LOK® cord

- Powerful 8.0 amp motor, 0 to 850 rpm, variable speed control
- Grip strength - exclusive, all metal ratcheting chuck with carbide jaws has the highest grip torque on bits
- All metal gear case and diaphragm
- 360° locking side handle
- Ergonomic tactile grip and two finger trigger for user comfort and balance
- Includes 1/2" Magnum® Drill, Side Handle
- Voltage: 120 AC, Amps: 8.0
- No Load RPM: 0-850
- Chuck Type: Single Sleeve w/Spindle Lock
- Wood Capacity-Auger Bit: 1/12", Self-Feed Bit: 2-9/16"
- Metal Capacity-Hole Saw: 2"
- Chuck Size: 1/2"
- Spindle: 1/2 in.-20
- Cord Type: 8 ft. QUIK-LOK®
- Tool Weight: 5.6 lbs



Part #	Mfg #	Description	Price
903855	0302-20	1/2" Magnum® Drill	251.92

### 18-Volt Cordless Power Tools

#### M18™ 18V Cordless Compact Drill Driver

- 1/2 in. Ratcheting Chuck with plastic sleeve
- Heavy-Duty 2-Speed Metal Gear Box: 0-350/0-1,400 rpm
- Compact Length (7-3/4 in.) fits in tight areas
- Compact Motor delivers 400 in.-lbs. of maximum torque
- Built-in LED light illuminates work surfaces
- Includes: 18V Lithium-ion Battery Pack, Charger, 1/2" 3-Jaw Keyless Chuck
- Voltage: 18V
- Torque: 400 in.-lbs.
- Chuck Size: 1/2 in.
- Clutch Settings: 21
- No Load Speed: 350/1,400
- Chuck Type: Keyless
- Capacity in Steel: 1/2 in.
- Capacity in Wood: 1 in.
- Tool Weight: 4.0 lbs.



Part #	Mfg #	Description	Price
937762	2601-22	M18™ Cordless Compact Drill	382.69

#### V18™ 18V LITHIUM-ION Battery Pack

- Superior cold weather performance which can be used down to -4°F (-20°C).
- Up to 50% longer run-time with no memory effect
- Consistent "fade-free" power from the first cut to the last
- Lightweight - 18V power with 14.4V NiCd Battery weight



Part #	Mfg #	Description	Price
937760	48-11-1830	V18™ LITHIUM-ION Battery	182.69



## Power Drills



### 28 Volt Cordless Power Tools

#### M28™ Cordless 28V 1/2 in. Hammer-Drill

- Revolutionary 28V LITHIUM-ION Technology
- 750 in.-lbs. of Maximum Torque
- 1-2" all-metal, single-sleeve ratcheting chuck with carbide jaws
- Up to 2X run-time of 18V tools
- Includes: (2) 28V Lithium-ion Batteries, Charger, Side Handle, No. 2 Phillips Bit
- Voltage: 28DC
- Speed: 450/1,800
- Torque: 750 in.-lbs.
- Tool Weight: 6.7 lbs



Part #	Mfg #	Description	Price
937761	0726-22	M28™ Cordless Hammer-Drill	604.85

#### M28™ Cordless 28V Portable Band Saw

- Revolutionary 28 Volt LITHIUM-ION Technology
- 4-3/4 in. x 4-3/4 in. capacity
- Worm gear and chain drive
- Perfectly balanced
- LED Light
- Includes: 28V Lithium-ion Battery, 1-Hour Charger
- Voltage: 28 DC
- No Load Speed: 225/350 FPM
- Capacity in Rectangular Stock: 4-3/4 in. x. 4-3/4 in.
- Tool Weight: 19.6 lbs.



Part #	Mfg #	Description	Price
937763	0729-21	M28™ Band Saw	807.69

### M28™ 28V LITHIUM-ION Battery Pack

- Milwaukee Digital Power Management System
- Overload Protection - Prevents user from damaging their cordless power tool investment in abusive situations
- Temperature Management System - Keeps battery in ideal temperature range to provide maximum life
- Individual Cell Voltage Monitoring - Ensures optimal charge and discharge for maximum life
- Discharge protection - prevents cell damage from over-discharge
- Battery fuel gauge - displays the remaining run-time
- 3 Year warranty



Part #	Mfg #	Description	Price
935137	48-11-2830	M28™ LITHIUM-ION Battery Pack	240.39

### Sawzall® Reciprocating Saws

#### 11 Amp Sawzall®

- Uses standard 1/2" shank Sawzall® blades; may be clamped upside down
- 120V with 8' HD "S" jacket 2-wire rubber cord
- Quik-Lok® blade clamp
- Direct access to blade clamp screw and pivot shoe adjusting screws
- Rubber boot for superior gripping
- Double bearing wobble plate
- Includes:
  - (1) Super Sawzall® blade
  - Steel carrying case



Part #	Mfg #	Stroke Length	Strokes Per Minute	Price
224468	6509-22	3/4"	0-2800	167.90

#### 18V Sawzall® Cordless Kit

- Uses standard 1/2" shank Sawzall® blades, may be clamped upside down
- Cuts up to (72) 2x4's on a single charge
- Keyless blade clamp
- Includes:
  - 2.4 Amp-Hr 18V battery
  - 1-Hour NiCd AC charger
  - (2) Super Sawzall® blades
  - Impact resistant carrying case



Part #	Mfg #	Stroke Length	Strokes Per Minute	Price
808486	6515-27	1"	0-2700	289.48

Tools



## Tools

Tools

### Electric Band Saw

#### Deep Cut Portable Band Saw

- 6.0 Amp A/C motor brush and high output fans
- 120V with 8' cord
- Uses standard 44-7/8" x 1/2" x .020" band saw blades
- Cuts up to 4-3/4" x 4-3/4" rectangular stock and 4-3/4" round stock
- Self lubricating
- Excellent balance
- Open line of sight
- Blade tightening lever
- Includes:
  - 14 TPI Super-Tough® bi-metal blade
  - Steel carrying case



Part #	Mfg #	Speed (No Load)	Price
17152	6232-6	0-350 ft-min	394.41

### 14" Abrasive Cut-Off Machine

- 120V AC/DC
- 15 Amp, 5.4 maximum hp motor
- 5-3/8" Pipe cutting capacity
- For use with abrasive cut-off wheels (14" x 3/32" x 1")
- Completely tool-free
- 45° Bevel capacity
- Spindle lock for convenient changing of abrasive wheels
- Pivoting wheel guard
- Easily accessible brushes
- Horizontal D-handle
- 14" Wheel size
- Includes:
  - Abrasive wheel



Part #	Mfg #	Speed (No Load)	Price
123257	6180-20	3900 rpm	264.87

### Band Saw Blades

#### Master-Band® Premium Portable

- Bi-metal portable, 8% cobalt high speed steel alloy cutting edge
- 3' 8-7/8" L x 1/2" W x .023T



Part #	Mfg #	TPI	Application	Pk	Price
17934	80115-38-EW-14	14	3/16" - 3/8"	3	14.96
17935	80116-38-EW-18	18	3/32" - 1/4"	3	14.96

### Band Saw Blades (Continued)

#### Master-Band® Premium Portable

Part #	Mfg #	TPI	Application	Pk	Price
232726	80117-38-EW-24	24	Up to 1/8"	3	40.80

### Milwaukee Replacement Parts

#### Drill Chucks

- Tightens the jaws of 1/2" capacity chuck



Part #	Mfg #	Description	Price
17246	48-66-3280	Chuck Key	7.10

#### Replacement Hex Key

Part #	Mfg #	Description	Price
114144	49-96-0070	5/32" Hex Key (Socket)	0.90

### Cut-Off Machine Wheels

- A36P Type 1
- General purpose, metal cutting
- 1" Arbor diameter, reinforced
- Uses (3) types of abrasive grains: Aluminum Oxide, Silicon Carbide, and Zirconia Alumina
- Tested for balance, resulting in smooth vibration-free grinding and cutting



Part #	Mfg #	Description	Price
17343	49-93-6220	12" x 3/32", Safe to 5,000 rpm	55.00
17344	49-93-6230	14" x 3/32", Safe to 4,350 rpm	53.75

### Grinder Wheels

#### 7" Aluminum Oxide Grinding Wheel

- Size: 7" x 1/4"
- Arbor: 7/8"
- Type: Aluminum Oxide Grinding Disc
- Type 27 raised hub



Part #	Mfg #	Description	Price
17345	49-93-3113	7" x 1/4" x 7/8" Stainless	6.85



## Tools



### 4-1/2" Metal Grinding Wheel

- 4-1/2 inch x 1/4 inch x 5/8-11 inch
- A24R Type 27
- Comprehensive offering for general purpose to specialized high performance applications
- Consistent performance from wheel to wheel through superior manufacturing processes
- Tested for balance, resulting in smooth, vibration free grinding and cutting



Part #	Mfg #	Description	Price
939808	49-94-4515	4-1/2" x 1/4" x 5/8-11"	6.12



### Magnetic Power Nut Drivers

- For fast work when driving of 1/4" & 5/16" hex-head washer screws, including speed screws, sheet metal screws & no-hub couplings
- Inserts in 1/4" & 3/8" drill chucks
- Bagged

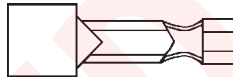

Part #	Mfg #	Size	Price
53557	72136	1/4"	3.52
136391	72138	5/16"	5.01



### Masonry Drill Bits

#### Regular Length Rotary Masonry Drill Bits

- Deep flute
- 4" Long
- Carbide tipped



Part #	Mfg #	Diameter	Shank Diameter	Price
16909	CM8-1/4	1/4"	1/4"	2.48
16910	CM8-3/8	3/8"	1/4"	6.02

#### 6" Rotary Masonry Drill Bits

- Deep flute
- Long length
- Carbide tipped



Part #	Mfg #	Diameter	Shank Diameter	Price
16911	CM86-1/2	1/2"	1/4"	7.67
16913	CM86-3/4	3/4"	1/2"	13.75

### 29-Piece Drill Set

- 1/16" Through 1/2" x 64ths



Part #	Mfg #	Description	Price
214571	129C	#705	122.45

Tools



**Tools**

Tools

**Insert Bits**

- Compact 1" standard length
- Made of high-grade S2 tool steel
- Milled for a precise fit
- On the Rockwell hardness scale, Irwin® bits are between 58 and 62



**Phillips® Insert Bits**

- Applications: appliance, automotive, aviation, decking, dry wall, electronics, furniture assembly, general construction and HVACR

Part #	Mfg #	Point Size	Shank Dia	Overall Length	Pkg	Price
877159	3510112C	#2	1/4"	1"	2-Pc	1.60

**Slotted Insert Bits**

- Used for common round-head, oval-head and flat-head fasteners



Part #	Mfg #	Point Size	Shank Dia	Overall Length	Pkg	Price
877160	3511112C	6-8	1/4"	1"	2-Pc	1.54

**Magnetic Insert Bit Holders**

- C-ring design contains an internal clip that fits into the retaining ring notch of the insert bit to hold the bit securely in place
- Can be used with socket wrench or socket adapter
- Designed for insert bits only



Part #	Mfg #	Description	Pkg	Price
877164	3557121C	2-1/4" Standard w/C-Ring	1-Pc	6.30

**Power Bits**

**Phillips Head Power Bits**

- Used in high torque power tools
- Designed for use in power drill chuck and chuck adapter



Part #	Mfg #	Type	Size	Price
877162	3520071C	#2 Phillips	1-15/16"	1.30

**Slotted Power Bits**

- Used for common round, oval, and flat head fasteners
- Designed for use in power drill chuck and chuck adapter



Part #	Mfg #	Type	Size	Price
877166	3521111C	8-10 Slotted	1-15/16"	1.28

**Fastener Drive Sets**

**30-Piece Fastener Drive Set**

Includes:

Qty	Stock #	Description
2	92005	#1 Phillips Insert Bit
7	92011	#2 Phillips Insert Bit
2	92019	#3 Phillips Insert Bit
1	92203	#1 Sq Recess Insert Bit
5	92205	#2 Sq Recess Insert Bit
1	92207	#3 Sq Recess Insert Bit
1	92111	6-8 Slotted Insert Bit
1	92113	8-10 Slotted Insert Bit
1	92115	10-12 Slotted Insert Bit
1	93712	2-1/4" Magnetic Bit Holder
2	353202	#2/#2 Phillips Double End Bit
1	353203	#2 Sq Recess Double End
1	93525	8-10 Slotted Double End Bit
2	94812	1/4" Magnetic Nutsetters - 2-9/16"
1	94832	5/16" Magnetic Nutsetters - 2-9/16"
1	94852	3/8" Magnetic Nutsetters - 2-9/16"
1	94872	7/16" Magnetic Nutsetters - 2-9/16"



Part #	Mfg #	Description	Price
877176	357030	(4) Magnetic Nutsetters, (21) Contractor Grade Insert Bits, (4) Dbl-end Power Bits & Magnetic Bit Holder	32.47

**Nutsetters**

**Lobular Design Magnetic Nutsetters**



Part #	Mfg #	Dia x OAL	Price
877156	3548121C	1/4" x 2-9/16"	4.88
877158	3548521C	3/8" x 2-9/16"	5.45
877157	3548321C	5/16" x 2-9/16"	5.31





## Tools



### Hammer Drill Bits

#### Straight Shank Rotary Percussion Bits



Part #	Mfg #	Dia x OAL	Twist Length	Price
877189	326003	3/16" x 6"	4-1/2"	4.16
877190	326005	1/4" x 4"	2"	3.83
877191	326006	1/4" x 6"	4"	4.36
877192	326009	5/16" x 6"	4"	4.81
877193	326011	3/8" x 6"	4"	7.18
877194	326015	1/2" x 6"	4"	10.29

### SDS-Plus Standard Tip Bits



Part #	Mfg #	Dia x OAL	Twist Length	Price
877181	322016	1/4" x 4"	2"	4.71
877183	322017	1/4" x 6"	4"	5.13
877186	322024	3/8" x 6"	4"	6.86
877187	322031	1/2" x 6"	4"	8.56

### Woodboring Drill Bits

#### Power Drill Installer Bits



Part #	Mfg #	Dia x OAL	Shank Size	Price
877135	39106	3/8" x 18"	.370"	18.45
877136	39108	1/2" x 18"	.370"	21.35
877137	39110	5/8" x 18"	.370"	27.02
877138	39112	3/4" x 18"	.370"	32.17

### Metal Twist Drill Bits

#### Black and Gold HSS Fractional Straight Shank Jobber Length Drill Bits



Part #	Mfg #	Dia x OAL	Twist Length	Price
877101	3019003B	3/64" x 1-3/4"	3/4"	1.05
877078	3019004B	1/16" x 1-7/8"	7/8"	1.05
877079	3019005B	5/64" x 2"	1"	1.05
877080	3019006B	3/32" x 2-1/4"	1-1/8"	1.20
877081	3019007B	7/64" x 2-5/8"	1-1/2"	1.20
877082	3019008B	1/8" x 2-3/4"	1-4/8"	1.24
877083	3019009B	9/64" x 2-7/8"	1-3/4"	1.37
877084	3019010B	5/32" x 3-1/8"	2"	1.37
877085	3019011B	11/64" x 3-1/4"	2-1/8"	1.56
877086	3019012B	3/16" x 3-1/2"	2-5/16"	1.76

### Metal Twist Drill Bits (Continued)

#### Black and Gold HSS Fractional Straight Shank Jobber Length Drill Bits

Part #	Mfg #	Dia x OAL	Twist Length	Price
877087	3019013B	13/64" x 3-5/8"	2-7/8"	2.03
877088	3019014B	7/32" x 3-3/4"	2-1/2"	2.19
877089	3019015B	15/64" x 3-7/8"	2-5/8"	2.38
877090	3019016B	1/4" x 4"	2-3/4"	2.63
877091	3019017B	17/64" x 4-1/8"	2-7/8"	3.14
877092	3019018B	9/32" x 4-1/4"	2-15/16"	3.66
877093	3019019B	19/64" x 4-3/8"	3-1/16"	3.97
877094	3019020B	5/16" x 4-1/2"	3-3/16"	4.02
877095	3019021B	21/64" x 4-5/8"	3-5/16"	4.50
877096	3019022B	11/32" x 4-3/4"	3-7/16"	5.07
877097	3019023B	23/64" x 4-7/8"	3-1/2"	5.73
877098	3019024B	3/8" x 5"	3-5/8"	5.59
877099	3019025B	25/64" x 5-1/8"	3-3/4"	6.57
877100	3019026B	13/32" x 5-1/4"	3-7/8"	6.74
877102	3019027B	27/64" x 5-3/8"	3-15/16"	7.47
877103	3019028B	7/16" x 5-1/2"	4-1/16"	7.99
877104	3019029B	29/64" x 5-5/8"	4-3/16"	9.30
877105	3019030B	15/32" x 5-3/4"	4-5/16"	9.41
877106	3019031B	31/64" x 5-7/8"	4-3/8"	9.82
877107	3019032B	1/2" x 6"	4-1/2"	9.84

### Black Oxide Drill Bit Sets

- Durable rubber-sided case for added impact resistance
- Sliding latch design provides added security
- 135° Split point prevents walking
- Black oxide coating resists corrosion



314015



314018

Part #	Mfg #	Description	Price
877076	314015	15-Pc Set, (2)1/16", 5/64", (2)3/32", 7/64", (2)1/8", 9/64", 5/32", 3/16", 7/32", 1/4", 5/16", and 3/8"	28.01
877108	314018	18-Pc Set, (2)1/16", 5/64", (2)3/32", 7/64", (2)1/8", 9/64", 5/32", 11/16", 3/16", 13/64", 7/32", 1/4", 5/16", 3/8" and 1/2" HSS Fractional Straight Reduced Shank, Heavy Duty, Jobber Length	40.81

Prices & specifications are subject to change.

Our faucet parts counter is one of the largest in the Boston area with thousands of parts in stock!



**Tools**

Tools

**Speedbor® Spade Bits**

**Standard**



- 6" Long with 1/4" shank

Part #	Mfg #	Diameter	Price
877114	88804	1/4"	3.78
877111	88806	3/8"	3.82
877115	88808	1/2"	3.82
877109	88810	5/8"	4.21
877117	88812	3/4"	4.21
877120	88814	7/8"	4.41
877122	88816	1"	4.65
877123	88818	1-1/8"	6.73
877124	88820	1-1/4"	6.73
877126	88824	1-1/2"	6.73

**Extra-Long**



- 16" Long with 1/4" shank

Part #	Mfg #	Diameter	Price
877127	88706	3/8"	11.28
877128	88708	1/2"	11.87
877129	88710	5/8"	12.48
877130	88712	3/4"	13.10
877131	88714	7/8"	13.63
877132	88716	1"	14.26

**Speedbor Sets**

- Blue-Groove point and cutting edge for faster chip removal - 4 times faster than standard spade bits
- Double cutting spurs scribe the outside of the hole reducing breakout
- 10% Larger shank for added durability
- Grooved hex shank prevents slipping in drill chuck or bit extension
- Fits all standard quick change chucks



Part #	Mfg #	Description	Price
877167	341008	8-Pc Set, 3/8", 1/2", 5/8", 3/4" 1", 1-1/8" & 1-1/2"	41.50



**Vari-Bits®**

**Vari-Bit® Step Drill Bits**

- High speed steel construction and steam oxide coating
- (2) Cutting flutes for clean burr-free holes

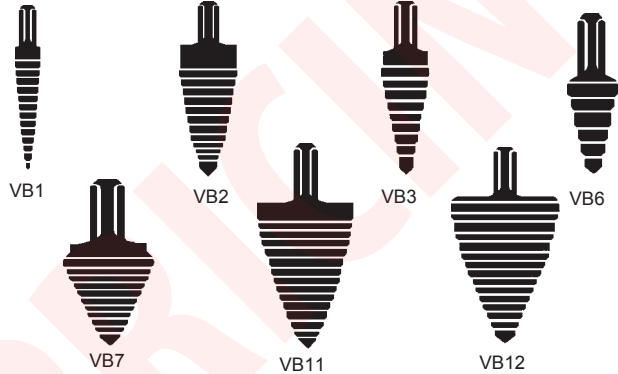

Part #	Mfg #	Number Hole Sizes	Hole Sizes	Electric Drill Size	Price
17927	VB1	13	1/8" - 1/2"	1/4"	40.64
17928	VB2	9	1/2" - 1"	3/8"	70.80
17929	VB3	9	1/4" - 3/4"	3/8"	62.06
17930	VB6	2	3/8", 1/2"	1/4"	39.68
17931	VB7	1	7/8"	3/8"	70.10
17932	VB11	2	7/8", 1-1/8"	3/8"	95.01
17933	VB12	5	7/8" - 1-3/8"	3/8"	108.64

**Vari-bit™ Extension**

Part #	Mfg #	Description	Price
17922	VBX8	8" Extension, 1/Clam Fits 3/8" Drill Chuck & Larger	25.58

**Lenox Leader® Wood Bit Kits**

- Includes:
  - (1) Each of leader bits 1", 1-1/8", 1-1/4", 1-1/2", 1-3/4"
  - 2-1/8", 2-9/16"; 5-1/2" extension,
  - (5) Lead screws
  - Slim taper file with handle
  - Hex wrench set
  - Plastic case



Part #	Mfg #	Description	Price
119681	33700	Wood Bit Kit	317.49



## Tools



### Utility Knives

#### Lenox® Gold™ Quick Change Knives



20353



GOLD5C, GOLD50D

Part #	Mfg #	Description	Price
861273	20353-SSRK1	Retractable Blade Knife with (3) Blades	22.77
861376	20350-GOLD5C	Replacement Blades, 5/Pk	3.75



### Knives

#### Utility Knife

- Heavy-duty construction
- Coated case



Part #	Mfg #	Description	Price
18054	K50-041	Utility Knife	6.30
18055	K50-042	Knife Blade, 5/Pk	1.67

## SHEFFIELD

#### Sheffield 12090 One Hand Opening Knife



- One hand opening Knife
- 3-3/8-Inch Blade; 4-3/8-Inch Closed Stainless Steel Blade
- Walker Lock
- Partially Serrated Blade
- Pocket Clip

Part #	Mfg #	Description	Price
952439	12090	One Hand Opening Knife	8.78

#### Sheffield 12925 Professional Folding Pocket Knife



- Features a 2 3/4" partially serrated stainless steel tanto blade
- 4" aluminum handle
- Thumb studs
- Pocket Clip
- Lanyard opening

Part #	Mfg #	Description	Price
954232	12925	Professional Folding Pocket Knife	8.78

#### Sheffield 12705 Boreal Folding Pocket Knife



- 3" Stainless Steel Drop Point Blade
- Ambidextrous Thumb Studs
- Polished Hardwood Handle
- Nylon Belt Pouch Included
- 7-1/2" overall length, 5 oz. total weight.

Part #	Mfg #	Description	Price
954233	12705	Boreal Folding Pocket Knife	12.58



### Hand Hacksaw Frames

#### High Tension Frame

- Ergonomic design
- Handle holds up to 12" hacksaw blades for quick change outs
- Larger space fits gloved hands
- Mount at 45° for flush cutting
- Insert standard reciprocating blade to use as jab saw
- 30,000 psi



Part #	Mfg #	Description	Price
17794	HT-50	High Tension Metal Cutting	40.86

#### Lightweight, All-Metal Frame

- Uses wing nut to adjust tension quickly
- 13,000 psi



Part #	Mfg #	Description	Price
17793	2012	General Purpose Cutting	18.50

#### Low Profile Frame

- Low profile tip easily handles close-quarter cuts
- 28,000 psi



Part #	Mfg #	Description	Price
206465	5012	High Tension Metal Cutting in Tight Spots	32.90

Tools

Prices & specifications are subject to change.

Our office hours are 7am to 4:30pm and counter hours 6am to 4:30pm Monday through Friday.



## Tools



Tools

### Hand Saws

#### Compact Hacksaw

- Heavy-duty aluminum handle
- Allows for flush cutting applications



Part #	Mfg #	Description	Price
17796	975	Multi-Purpose	12.38

#### Close Quarter® Saw

- Reaches into tight spaces where standard won't fit



Part #	Mfg #	Description	Price
17936	908	Close Quarter Saw	18.40
17937	906	Close Quarter Blades 6" x 1/4" x .014 x 32T	16.10

### Bi-Metal Hacksaw Blades

- Bi-metal construction allows blades to bend and flex without breaking
- TUFF TOOTH™ design eliminates tooth strippage



Part #	Mfg #	TPI	Len x Wid	Price
17783	018HE	18	10" x 1/2"	2.12
17785	024HE	24	10" x 1/2"	2.12
17787	032HE	32	10" x 1/2"	2.12

#### Tri-Fold® Saw

- Complete with reciprocating blade
- Locks into (3) different positions for cutting anything from wood to dry wall, to stainless steel at any angle
- Uses any reciprocating blade with 1/2" tang



Part #	Mfg #	Description	Price
17808	3636	Wood, Dry wall & Non-Metallic Cutting	33.23

### PVC/ABS Plastic Pipe Hand Saw

- Wide rigid carbon steel blade with hardened teeth
- Cut any size diameter plastic pipe, wood and nail-embedded wood
- Heavy-duty lightweight aluminum handle



Blade & Handle



Blade

Part #	Mfg #	Description	Price
17797	HSF12	12" Blade & Handle	25.42
17798	HSF18	18" Blade & Handle	28.52
17805	HSB12	12" Replacement Blade	12.03
17806	HSB18	18" Replacement Blade	15.31



## Custom Reporting

Need a year's worth of your purchase history? No problem! Our custom reporting capabilities allow us to get you the information you need – quickly.



## Tools



### Hole Saws

#### Bi-Metal Hole Saws

- TUFF TOOTH™ design is reinforced to cut stronger and last longer
- Patented VARI-TOOTH® design resists tooth stripping
- High speed steel teeth resist breaking and offer extended life
- (1) Per box



Part #	Mfg #	Dia	Pipe Tap	Pipe Entr	Price
17859	10L	5/8"	-		11.67
17860	12L	3/4"	1/2"	3/8"	11.67
17861	14L	7/8"	3/4"	1/2"	11.67
17862	16L	1"	-		12.64
17863	17L	1-1/16"	-		12.64
17864	18L	1-1/8"	1"	3/4"	12.64
17865	20L	1-1/4"	-		12.64
17866	22L	1-3/8"	-	1"	13.31
17867	24L	1-1/2"	1-1/4"		13.31
17868	26L	1-5/8"	-		13.31
17869	28L	1-3/4"	1-1/2"	1-1/4"	16.73
17870	30L	1-7/8"	-		16.73
17871	32L	2"	-	1-1/2"	16.73
17872	33L	2-1/16"	-		20.19
17873	34L	2-1/8"	-		20.19
17874	36L	2-1/4"	2"		20.19
17875	38L	2-3/8"	-		20.19
17876	40L	2-1/2"	-	2"	21.76
17877	42L	2-5/8"	2-1/2"		21.76
17878	44L	2-3/4"	-		21.76
17879	46L	2-7/8"	-		21.76
17880	48L	3"	-		22.53
17881	50L	3-1/8"	-		23.15
17882	52L	3-1/4"	3"		23.15
17883	54L	3-3/8"	-		23.15
17884	56L	3-1/2"	-		23.15
17885	58L	3-5/8"	-	3"	26.78
17886	60L	3-3/4"	3-1/2"		31.63
17888	64L	4"	-		34.06
17889	66L	4-1/8"	-	3-1/2"	36.98
17890	68L	4-1/4"	4"		48.48
17891	72L	4-1/2"	4-1/2"	4"	66.85
17892	76L	4-3/4"	-		74.34
17893	80L	5"	-		82.47
17894	88L	5-1/2"	-		98.81
17895	96L	6"	-		115.32

### Starrett Economy Bi-Metal Hole Saws

- Hardened, heat resistant, positive rake HSS teeth with alloy backing.
- Strong and shatter resistant.
- Economically cuts wood, metal and steel.
- For hand held or fixed drills. 1-5/8" cutting depth.



Part #	Mfg #	Dia	Pipe Tap	Pipe Entr	Price
954895	KDH0058-N	5/8"	-		8.50
954896	KDH0034-N	3/4"	1/2"	3/8"	8.50
954897	KDH0078-N	7/8"	3/4"	1/2"	8.50
954898	KDH0100-N	1"	-		8.92
954899	KDH0116-N	1-1/16"	-		8.92
954900	KDH0118-N	1-1/8"	1"	3/4"	8.92
954901	KDH0114-N	1-1/4"	-		9.02
954902	KDH0138-N	1-3/8"	-	1"	9.65
954903	KDH0112-N	1-1/2"	1-1/4"		9.65
954904	KDH0158-N	1-5/8"	-		9.65
954905	KDH0134-N	1-3/4"	1-1/2"	1-1/4"	11.87
954907	KDH0178-N	1-7/8"	-		11.87
954906	KDH0200-N	2"	-	1-1/2"	11.87
954908	KDH0218-N	2-1/8"	-		14.77
954909	KDH0214-N	2-1/4"	2"		14.77
954910	KDH0238-N	2-3/8"	-		14.77
954911	KDH0212-N	2-1/2"	-	2"	15.82
954912	KDH0258-N	2-5/8"	2-1/2"		15.82
954914	KDH0234-N	2-3/4"	-		15.82
954915	KDH0300-N	3"	-		16.26
954916	KDH0314-N	3-1/4"	3"		16.26
954917	KDH0312-N	3-1/2"	-		16.27
954918	KDH0358-N	3-5/8"	-	3"	19.22
954919	KDH0400-N	4"	-		24.76
954920	KDH0412-N	4-1/2"	4-1/2"	4"	48.81
954921	KDH0500-N	5"	-		60.10
954922	KDH0600-N	6"	-		84.03

Tools

Prices & specifications are subject to change.

You can check stock availability, pricing and place orders online at [www.MetPipe.com](http://www.MetPipe.com).



**Tools**



**Carbide Tipped Hole Saw - Lenox Blue**

- Cuts abrasive materials, lasts up to 10 times longer than standard
- Uses standard arbors, recommend carbide tipped pilot drill
- (1) Per box



Part #	Mfg #	Dia	Pipe Tap	Pipe Entr	Price
40300	12CT	3/4"	1/2"	3/8"	26.06
40302	14CT	7/8"	3/4"	1/2"	27.43
40303	16CT	1"	-	-	28.94
40304	18CT	1-1/8"	1"	3/4"	30.11
40306	22CT	1-3/8"	-	1"	34.66
40307	24CT	1-1/2"	1-1/4"	-	36.33
40308	28CT	1-3/4"	1-1/2"	1-1/4"	38.78
40309	32CT	2"	-	1-1/2"	44.07
40310	34CT	2-1/8"	-	-	45.38
40311	36CT	2-1/4"	2"	-	50.28
40312	40CT	2-1/2"	-	2"	53.74
40313	48CT	3"	-	2-1/2"	59.24
40314	58CT	3-5/8"	-	3"	79.66
40315	64CT	4"	-	-	87.96
40316	66CT	4-1/8"	-	3-1/2"	94.92
40317	76CT	4-3/4"	4-1/2"	4"	137.97
860195	80CT	5"	-	-	153.55

**Starrett Diamond-Grit Hole Saw**

- Diamond edge hole saws with synthetic diamond grit bonded over a durable steel platform. For cutting hardened steels and non-metallics such as fired ceramics and aggregate containing (concrete) materials
- Synthetic diamond grit bonded over a durable steel platform
- Better life when cutting hardened steels, fired ceramics or aggregate containing (concrete) materials
- Always start with low (or recommended) speed (RPMs). Speed can be increased as ease of cutting is noticed. Avoid extreme heat build-up on the cutting surface
- Coolant recommended



**Starrett®**  
Diamond

Part #	Mfg #	Dia	Pipe Tap	Pipe Entr	Price
954923	KD0058-N	5/8"	-	-	32.29
954924	KD0034-N	3/4"	1/2"	3/8"	32.29
954925	KD0078-N	7/8"	3/4"	1/2"	32.29
954926	KD0100-N	1"	-	-	35.27
954927	KD0100-N	1-1/4"	-	-	36.18
954928	KD0138-N	1-3/8"	-	1"	36.18
954930	KD0112-N	1-1/2"	1-1/4"	-	36.50

**Hole Saws (Continued)**

**Starrett Diamond-Grit Hole Saw**

Part #	Mfg #	Dia	Pipe Tap	Pipe Entr	Price
954931	KD0158-N	1-5/8"	-	-	36.50
954932	KD0134-N	1-3/4"	1-1/2"	1-1/4"	44.73
954934	KD0200-N	2"	-	1-1/2"	44.73

**Hole Saw Arbors**

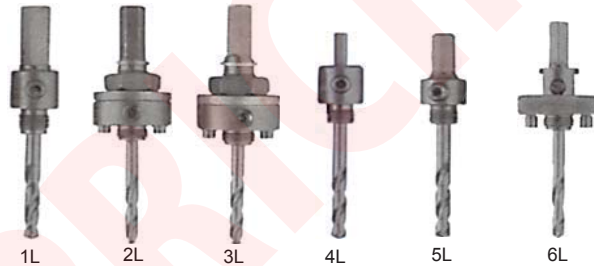

Part #	Mfg #	Fits Saw	Pipe Tap	Pipe Entr	Shank Size	Price
954931	1L	9L-19L	1/2"	Hex	1/2"	36.50
954932	2L	20L-96L	1/2"	Hex	1/2"	44.73
954934	3L	20L-96L	1/2"	Hex	1/2"	44.73
17899	4L	9L-19L	1/4"	3-Side	1/4"	11.65
17900	5L	9L-19L	3/8"	Hex	3/8"	17.02
17901	6L	20L-96L	3/8"	Hex	3/8"	27.23

**Lenox Snap-back Hole Saw Arbors**

- Faster and easier to engage / disengage hole saw
- Prevents threads from stripping - drives off pins, not threads
- Prevents hole saw from locking on arbor
- Arbor threads directly into all hole saws
- Easy plug removal



Part #	Mfg #	Fits Saw	Pipe Tap	Pipe Entr	Shank Size	Price
946209	2L	20L-96L	1/2"	Hex	1/2"	31.09
946210	5L	9L-19L	3/8"	Hex	3/8"	21.02
946211	6L	20L-96L	3/8"	Hex	3/8"	28.65



## Tools



### Starrett Hole Saw Arbor & Pilot Bits



Part #	Mfg #	Size	Price
954935	KA1-N	3/8"	11.75
954936	KA2-N	1/2"	17.80

### For Diamond Grit Hole Saws

Part #	Mfg #	Size	Price
954937	XA-1	3/8"	29.50
954938	XA-2	1/2"	40.60

### Hole Saw Accessories



Part #	Mfg #	Description	Price
40318	123CT	1/4" Pilot Drill	12.43
17905	4321	1/4" Pilot Drill Fits 1L, 2L, 4L	5.93
17906	56PD	1/4" Pilot Drill	5.02
17907	AA1	Arbor Adaptor 1L to 4L 5L	4.53
17921	55X	5-1/2" Extension	19.31
17923	12X	12" Extension	19.90
17924	18X	18" Extension	27.56

### Bi-Metal Hole Saw Kits

- Designed for professional trades
- 3/4", 7/8", 1-1/8", 1-1/2", 1-3/4", 2-1/4"
- Arbors 2L, 5L, (1) 4321 pilot drill, (1) arbor adaptor



Part #	Mfg #	Description	Price
17903	600P	Hole Saw Kit	152.24

### General Purpose - 26-Piece Kit

- 1-1/2", 1-3/4", 2", 2-1/8", 2-1/4", 2-1/2", 2-11/16", 3", 3-1/4", 3-3/8", 3-5/8", 3-3/4", 4-1/8", 4-1/2", 4-3/4"
- Arbors: 1L, 2L, 5L
- (2) 4321 and (1) 56PD pilot drills



Part #	Mfg #	Description	Price
223726	2000G	Big Daddy™ Hole Saw Kit	582.89

## Vendor Managed Inventory Program

Metropolitan Pipe can assist you in setting up your own *stockroom*- complete with barcodes for easy tracking.



Product ID: 454645

Kohler 4330-0 Kingston elongated wall-hung bowl with top spud



Aisle 7 - Shelf B

Tools



**Tools**



Tools

**Reciprocating Saw Blades**  
**Lenox Gold™ Reciprocating Blades**

- Longest lasting blade ever™
- Reinforced tooth design and precision applied titanium coating dissipate heat
- Titanium coating makes teeth more wear resistant so they stay sharp for quicker cuts
- Bi-metal design stands up to the most demanding applications



Part #	Mfg #	TPI	Length x Width x Thick	Pkg Qty	Applications	Price
861268	21060-656G	6	6" x 3/4" x .050"	5	Wood, Nail-Embedded Wood, Dry wall & Plaster	6.00
861272	21062-956G	6	9" x 3/4" x .050"	5	Wood, Nail-Embedded Wood, Dry wall & Plaster	7.90
861269	21067-614G	14	6" x 3/4" x .035"	5	Thick to Medium Metal (3/32" - 1/2")	5.05
861270	21069-618G	18	6" x 3/4" x .035"	5	Medium Metal (3/32" - 5/16")	5.05
861271	21070-818G	18	8" x 3/4" x .035"	5	Medium Metal (3/32" - 5/16")	6.34

**Demolition Blades**

- Engineered to rip through a wide array of materials with ease including structural steel, lumber, pipe & nail embedded wood
- Wider & thicker to stand up to the brutal conditions in demolition applications
- Shatter resistant, bi-metal design provides the flexibility & durability single-metal blades can't



Part #	Mfg #	TPI	Length x Width x Thick	Pkg Qty	Applications	Price
50481	20598-966R	6	9" x 7/8" x .062"	2	Demolition, Nail-Embedded Wood, Dry wall & Plaster	7.03
50483	20597-960R	10	9" x 7/8" x .062"	2	Demolition	7.03

**Lazer™ Reciprocating Saw Blades**

- Best for Extreme metal cutting
- Reinforced tooth design ensures higher performance in the most demanding jobs
- A wider, thicker body than conventional blades delivers whip-free cuts that stay straight & smooth
- Lasts up to 45% longer than competitors blades
- Shatter resistant, bi-metal design provides the flexibility & durability single-metal blades can't



Part #	Mfg #	TPI	Length x Width x Thick	Pkg Qty	Applications	Price
886079	20180-9118R	18	9" x 1" x .042"	5	Structural Steels & All Metals (1/16" - 1/4")	7.43

**Master-Grit® Reciprocating Saw Blades**

- Cuts through materials that resist chip-forming
- Uniformly applied, durable carbide grit particles on a flexible blade provide fast cuts without snagging or binding



Part #	Mfg #	Grit	Length x Width x Thick	Pkg Qty	Applications	Price
870731	20505-600RG	Medium	6" x 3/4" x .032"	2	Fiberglass, Ceramic Tile, Cultured Marble, Clays, Brick, Non-Ferrous Metal, Cement Board & Cast Iron	16.30
17829	20576-800RG	Medium	8" x 3/4" x .040"	2	Fiberglass, Ceramic Tile, Cultured Marble, Clays, Brick, Non-Ferrous Metal, Cement Board & Cast Iron	11.80





## Tools



### Bi-Metal™ Reciprocating Saw Blades

- Patented TUFF TOOTH™ design provides long blade life
- Optimized for specific applications
- Shatter resistant, bi-metal design

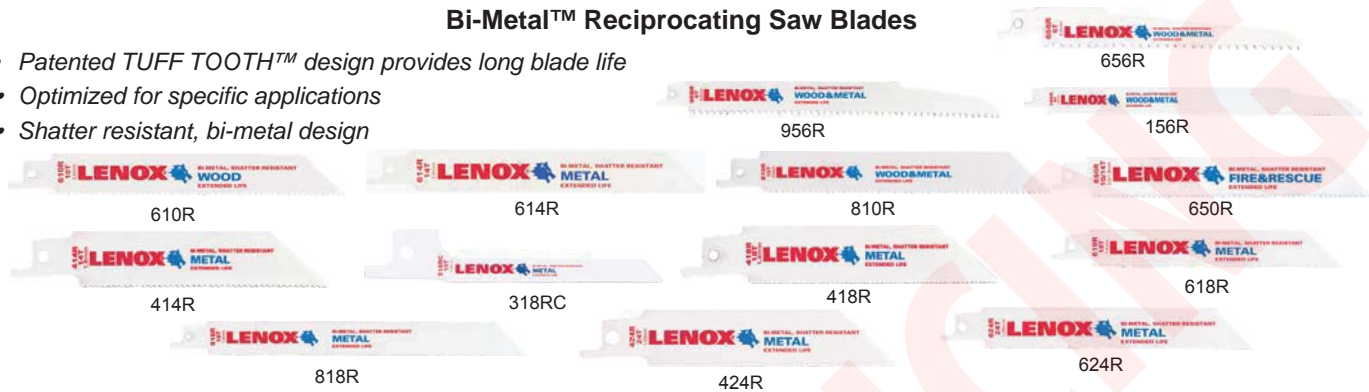

Tools

Part #	Mfg #	TPI	Length x Width x Thick	Pkg Qty	Applications	Price
17847	20572-656R	6	6" x 3/4" x .050"	5	Wood & Nail-Embedded Wood	5.02
17845	20570-636RP	6	6" x 3/4" x .050"	5	Dry wall & Plaster	5.02
17857	20582-956R	6	9" x 3/4" x .050"	5	Wood & Nail-Embedded Wood	6.65
17791	20585-156R	6	12" x 3/4" x .050"	5	Wood & Nail-Embedded Wood	8.12
17837	20562-610R	10	6" x 3/4" x .035"	5	Wood, Non-Ferrous Metal, Plastics & Composites	4.22
17839	20564-614R	14	6" x 3/4" x .035"	5	Non-Ferrous & Medium Metal (3/32" - 5/16")	4.22
17855	20580-810R	10	8" x 3/4" x .050"	5	Wood, Non-Ferrous Metal, Plastics & Composites	5.33
135816	20592-650R	10/14	6" x 3/4" x .050"	1	Demolition	5.25
17789	20583-110R	10/14	12" x 3/4" x .050"	5	Nail-Embedded Wood & Medium Metal (3/32" - 5/16")	8.12
17815	20550-414R	14	4" x 3/4" x .035"	5	Non-Ferrous & Medium Metal (3/32" - 5/16")	3.26
17823	20521-318RC	18	3" x 1/4" x .032"	5	Pressure-Treated Wood & Medium Metal (3/32" - 5/16")	3.96
17827	20552-418R	18	4" x 3/4" x .035"	5	Non-Ferrous & Thick Metal (1/8" & Less)	3.26
17841	20566-618R	18	6" x 3/4" x .035"	5	Non-Ferrous & Thin Metal (1/8" & Less)	4.22
17851	20578-818R	18	8" x 3/4" x .035"	5	Non-Ferrous & Thin Metal (1/8" & Less)	5.33
17830	20554-424R	24	4" x 3/4" x .035"	5	Thin Metal (1/8" & Less)	3.26
17843	20568-624R	24	6" x 3/4" x .035"	5	Thin Metal (1/8" & Less)	4.22
146278	20511-9514R	14	9" x 3/4" x .050"	2	HEAVY DUTY Pipe, Structural & Stainless Steel	6.40
135815	20594-6518R	18	6" x 3/4" x .050"	2	HEAVY DUTY Pipe, Structural & Stainless Steel	24.37

### Fastcut General Purpose Reciprocating Blades - Straight Shape

- Fastcut General Purpose Reciprocating Blades are excellent for all-around use.
- Straight blades are .035" thick, 3/4" wide, available in 4", 6", 8" lengths and with 8 to 24 TPI.



Part #	Mfg #	TPI	Length x Width x Thick	Pkg Qty	Applications	Price
954939	B414-5	14	4" x 3/4" x .035"	5	"Fastcut" General Purpose	13.39
954940	B418-5	18	4" x 3/4" x .035"	5	"Fastcut" General Purpose	13.39
954941	B424-5	24	4" x 3/4" x .035"	5	"Fastcut" General Purpose	13.39
954942	B610-5	10	6" x 3/4" x .035"	5	"Fastcut" General Purpose	15.35
954943	B614-5	14	6" x 3/4" x .035"	5	"Fastcut" General Purpose	15.35
954944	B618-5	18	6" x 3/4" x .035"	5	"Fastcut" General Purpose	15.35
954945	B624-5	24	6" x 3/4" x .035"	5	"Fastcut" General Purpose	15.35
954946	B818-5	18	8" x 3/4" x .035"	5	"Fastcut" General Purpose	20.91

Prices & specifications are subject to change.

Our state of the art pipe shop offers cutting, threading, grooving and make-ons up to 36in!



# Soldering Equipment



Tools

## Torches

### Pencil Flame Jet Torch

- Produces a 1/2" pencil point flame for detailed work



Part #	Mfg #	Model	Description	Price
110654	019100	JT681	Brass Torch Head	13.90

### Goss® Instant Ignition Trigger Torch

- Self-igniting
- Hot turbine flame
- Uses propane or MAPP gas
- Regulator minimizes flame deviation
- Fits 1 lb disposable cylinders (sold separately)



Part #	Mfg #	Description	Price
234401	GP-600	1/2" Flame Diameter	114.20

## TurboTorch®

### Acetylene Kits

#### Extreme™ Air Acetylene Kits

- Extreme™ Swirl Technology
- Traditional manual lighting torch
- All tips feature quick disconnect couplings
- AH-12 Hose
- G4 Handle
- Rear valve position



X-4B

Part #	Mfg #	Soft Solders To	Silver Brazes To	Tips	Price
18188	X-5B	1-1/2"	3/4"	A-5	278.00
18186	X-3B	3"	1-5/8"	A-3, A-11	356.00
18187	X-4B	3-1/2"	2"	A-5, A-14	369.00

#### "B" Tank, AR-B Regulator

## Extreme™ Air Acetylene Tips

- Quick disconnect couplings
- Color coded O-rings for gas identification
- Can be used with any Acetylene torch (PLF-A5 or G-4) handle



A-5

Part #	Mfg #	Tip Size	Soft Solder To	Silver Brazes To	Price
18189	A-2	1/8"	1/8"-1/2"	1/8"-1/4"	71.59
18190	A-3	3/16"	1/4"-1"	1/8"-1/2"	77.60
18191	A-5	1/4"	3/4"-1-1/2"	1/4"-3/4"	91.80
18192	A-8	5/16"	1"-2"	1/2"-1"	101.00
18193	A-11	7/16"	1-1/2"-3"	7/8"-1-5/8"	107.00
18194	A-14	1/2"	2"-3-1/2"	1"-2"	131.00
18195	A-32	3/4"	4"-6"	1-1/2"-4"	186.00

## Extreme™ Self-Igniting Air Acetylene Kits

- Extreme™ Swirl Technology
- Quick disconnect handle and tip
- AH-12 Hose
- 3-Year warranty



#### "B" Tank, AR-B Regulator, G4 Handle, Rear Valve

Part #	Mfg #	Soft Solders To	Silver Brazes To	Tips	Price
40291	PL-5ADLX-B	1-1/2"	3/4"	PL-5A	274.00

## Extreme™ Self-Igniting Acetylene Tips

- Color coded O-rings for gas identification



PL-5A

Part #	Mfg #	Tip Size	Soft Solders To	Silver Brazes To	Price
140194	PL-3A	1/4"	1/4"-1"	1/8"-1/2"	97.21
40292	PL-5A	3/16"	3/4"- 1-1/2"	1/4"-3/4"	124.00
40293	PL-8A	5/16"	1"-2"	1/2"-1"	129.00
40294	PL-12A	3/8"	2"-4"	1"-2"	135.00



## Soldering Equipment



### Swirl Air Acetylene Components Acetylene Torch Handles



Part #	Mfg #	Description	Price
18198	G-4	TurboTorch Handle	89.52

### Acetylene Regulators



Part #	Mfg #	Description	Price
18196	AR-B	Fits "B" Tank	106.00
115937	AR-MC	Fits "MC" Tank	118.00

### Acetylene Hose

- 3/16" ID with 3/8" 24-Thread LH nuts
- Fits G4 and PLF-A handle, AR-B and AR-MC regulators



Part #	Mfg #	Description	Price
18197	AH-12	12' Acetylene Hose	48.52
145658	AH-24	24' Acetylene Hose	83.49

### Oxy-Acetylene Kit

- This series of outfits is designed for Light Duty Cutting, Brazing and Heating jobs.
- All outfits include Oxy Regulator 221-05FP, Fuel Regulator 201-05FP, 12.5' Dual "A" 3/16 hose 252-03P, glasses and a striker.



Part #	Mfg #	Description	Price
165163	TTV-J-ACPT	Tote Kit with Tanks for Light-Duty Cutting, Brazing & Heating	911.40

### Propane & MAPP®

#### Proline Standard Propane & MAPP® Kits

- Includes:
  - R-LP Adjustable regulator
  - H-4 Handle
  - H-12 Hose
  - Instruction manual



LP-2

Part #	Mfg #	Soft Solders To	Silver Brazes To	Tips	Price
18199	LP-1	6"	4"	T-4, T-6	350.00
18200	LP-2	4"	2"	T-3, T-5	368.00
18201	LP-3	2-1/2"	1-1/4"	T-4	280.00

#### Proline Standard Propane & MAPP® Tips



T-3

Part #	Mfg #	Tip Size	LP Soft Solder To	MAPP Solder To	Price
18202	T-2	5/16"	1/8"-1/4"	1/8"-1/2"	88.92
18203	T-3	7/16"	1/4"-1"	1/4"-1-1/2"	91.48
18204	T-4	1/2"	1/4"-1-1/2"	1/4"-2-1/2"	110.00
18205	T-5	3/4"	1-1/2"-2-1/2"	1"-4"	116.00
18206	T-6	1"	1-1/2"-4"	1-1/2"-6"	139.00

#### Proline Self-Lighting Propane & MAPP® Tips



PL-5T

Part #	Mfg #	Tip Size	LP Soft Solder To	MAPP Solder To	Price
40297	PL-3T	3/8"	1/4"-1"	1/4"-1-1/2"	143.00
40298	PL-4T	7/16"	1/4"-1-1/2"	1/4"-2-1/2"	146.00
40299	PL-5T	5/8"	1-1/2"-2-1/2"	1"-4"	154.00

Tools

Prices & specifications are subject to change.

Metropolitan Pipe offers FREE DELIVERY in the Greater Boston area.



## Soldering Equipment



Tools

### "Total LP" Regulator

- Not for acetylene
- Brass construction, adjustable to 60 psi
- Fits standard POL valve & 9/16" 18 LH hose nut



Part #	Mfg #	Description	Price
18207	R-LP	Total LP Regulator	102.00

### H-4 Handle

- Valve rear & disconnect
- "B" Size 9/16"-18 hose connections



Part #	Mfg #	Description	Price
18210	H-4	Fits T-2 thru T-6	92.31

### Extreme™ Self-Lighting Propane & MAPP® Torch

- Quick disconnect couplings between handle & tips
- Suitable for high capacity applications
- 3-Year warranty



Part #	Mfg #	Description	Price
115379	TX504	Self-Lighting Hand Torch	121.00

### Extreme™ STK Propane & Mapp® Torch

- Extreme™ Swirl Technology
- 360° Interchangeable swivel tips
- Includes STK-R pressure regulator with CGA 600 connection



Part #	Mfg #	Description	Price
18213	STK-9	ST-3 Tip	88.00

### Extreme™ STK Hand Torch Tips

- Extreme™ Swirl technology
- 360° Swivel tips



Part #	Mfg #	LP Soft Solder To	MAPP Soft Solder To	Price
18214	ST-1	1/8"-1/2"	1/8"-3/4"	63.01
18215	ST-3	3/8" - 2-1/2"	1/4"-3-1/2"	77.41

### Extreme™ STK Self-Lighting Hand Torch Tip Assembly Only

- Fits existing ST-33, STK-99 & 44TL torches



Part #	Mfg #	Description	Price
200467	44TL-TE	Replacement Tip End	33.56

### Propane & MAPP® Snake Kit

- 360° Swivel flame tube
- Push trigger ignition
- STK-R Regulator
- TSR Tank rack with retainer



Part #	Mfg #	Handle	Hose	Tips	Price
158906	PS-3T	H-4	H-12	PL-3T	114.93

### Turbo Tanks & Cylinders Propane Non-Refillable Tank

- Use with TurboTorch hand torches and TT LP leak detector
- CGA 600 Connection



Part #	Mfg #	Description	Price
18181	PT-1	14.1 oz Propane	8.32

### MAPP® Gas Replacement Tank

- Use with TurboTorch dual fuel hand torches and TT LP leak detector
- CGA 600 Connection



Part #	Mfg #	Description	Price
18182	MT-1	16 oz of MAPP® Gas	11.12

### Regulators & Gauges Gauges



Part #	Mfg #	Description	Price
124130	AG-1	Fuel Gauge for Acetylene Regulator	40.80



## Soldering Equipment



### Alloys

#### Bronzeflow Brazing Alloys

- Not for stainless steel
- 1595°F - 1620°F Brazing range
- 63,000 psi Tensile strength
- Meets AWS A5.8, ASTM B-259, Federal QQR571B, MIL-R 19631B specifications



Part #	Mfg #	Description	Price
18218	BF-1	Steel Brazing Alloy	24.72

### TurboTorch® Parts & Accessories

#### Hoses



Part #	Mfg #	Description	Price
18211	H-12	H-12 12' LP or MAPP Hose (1412-0080)	59.49

#### Flints & Flint Strikers



L-1



F-1

Part #	Mfg #	Description	Price
18216	L1	Cup Type Single Flint Striker, Round File	4.06
18217	F1	Box of (5) Flints for L-1 Striker	3.27
120091	F3	Triple Striker Flint	4.20

#### Tank Keys



Part #	Mfg #	Description	Price
18249	TK	For "B" & "MC" Tank Valves	4.08

#### Fittings



BTMCR



MCT



ROF-LP

Part #	Mfg #	Description	Price
50180	BTMCR	"MC" Regulator to "B" Cylinder Adapter	38.92
41599	MCT	"B" Regulator to "MC" Cylinder Adapter	51.33
18208	ROF-LP	LP Regulator to Hose Outlet Fitting	25.28



### "B" Air Acetylene Kits

- Air acetylene piston regulator with TANKTOTE handle, GAUGEGUARD and 2" gauge
- AA Torch handle
- AA Hose
- TANKTOTE sleeve
- "B" Tank key



TANK NOT INCLUDED

Part #	Mfg #	Description	Price
877343	21835	LX3B Kit w/A3 3/16" Swirl Flame Tip	347.46

### Brazing Rods

- .125" x .050" x 20"
- Brazing rods for joining copper, brass and bronze

#### 0% Silver Brazing Rods - SF-1



- 0% Silver, 7.25% Phosphorus, balance Copper
- Melting temperature: 1310°F
- Flow temperature: 1460°F

Part #	Mfg #	Description	Price
811963	WS78162	1 lb Brazing Rods, 12/Pk	14.98

#### 15% Silver Brazing Rods - SS-15



- 15% Silver, 5% Phosphorus, balance Copper
- Melting temperature: 1190°F
- Flow temperature: 1475°F

Part #	Mfg #	Description	Price
811964	WS78171	1 lb Brazing Rods, 12/Pk	174.24

### Solder

#### 50/50 Leaded Solder

- 50% Tin, 50% lead solder
- For use in non-potable water applications



WS10098

Part #	Mfg #	Description	Price
17729	WS10098	1 lb Spool 50/50 Solder	18.85
17731	WS10257	1 lb Bar 50/50 Solder	19.53

Prices & specifications are subject to change.

Metropolitan Pipe offers Vendor Managed Inventory - never run out of that part again!



## Soldering Equipment



Tools

### 95/5 Lead-Free Solder

- Melting temperature: 455°F
- Tensile strength: 5500 psi



Part #	Mfg #	Description	Price
17730	WS15018	1 lb Spool 95/5 Solder	33.46

### Silvabrite 100® Lead-Free Solder

- Stronger than 50/50
- "The Safe-Water Solder"
- Wide melting range for easy use



Part #	Mfg #	Description	Price
17732		1/8" 1 lb Spool	34.48

### Heat Shields

#### The Insurance Pad®

- Asbestos free heat resistance to 2500°F
- Ideal for use with propane, MAPP gas, acetylene/air & higher temperature torches
- Fibrous felt heat shield



Part #	Mfg #	Description	Price
53838	71038	9" x 12" Display Pk	43.68



### "Jet Swet"™ Water Gate Jet Packs

- Solder without draining the entire water system
- Quick work on all full-port gate valves, ball valves and fittings

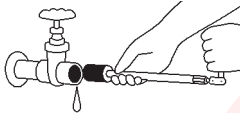

Part #	Mfg #	Description	Price
57164	6100	1/2" to 2" with Case	472.46

### "Jet Swet"™

- The "Jet Swet"™ gasket is a special EPDM/Silicon composite, made to withstand the intense heat of soldering and braising



Part #	Mfg #	Size	Price
57136	050	1/2"	73.47
57138	075	3/4"	78.81
57165	100	1"	81.59
57166	125	1-1/4"	97.55
57167	150	1-1/2"	100.47
57175	200	2"	117.21
57183	300	3"	465.69
57187	400	4"	549.18



## Abrasives

### Abrasive Products

#### Aluminum Oxide Open Nylon Mesh 180 Grit (Orange Box)

- Premium grade AAA
- For cleaning copper tube
- Waterproof
- Made with open nylon fabric, phenolic resin adhesive, and rugged aluminum oxide



Part #	Mfg #	Description	Price
17742	70100	1-1/2" x 10 yds	15.61
158543	70110	1-1/2" x 25 yds	32.62

#### Red Stuff 120 Grit Aluminum Oxide Sandcloth

- Original copper tubing cleaner
- Closed coat abrasive cloth with, "J" weight cotton backing



Part #	Mfg #	Description	Price
17734	70050	1-1/2" x 10 yds	7.12
17735	70060	1-1/2" x 25 yds	15.79

#### "Cloth Caddy" Sandcloth Dispenser

- Keeps sandcloth in like-new condition



Part #	Mfg #	Description	Price
185484	70950	Holds Up to 1-1/2" Wide x 10 yds	7.50

### Steel Wool



Part #	Size	Price
17737	Size 0	5.90

### Applicator Brushes

#### Acid, Solder Paste & Flux, Adhesive

- Coated tin paste, bright-finished metal handle
- Pure medium stiff, black, graded natural horsehair bristles



70210



70240

Part #	Mfg #	Size	Wire	Price
17755	70210	#1	1/4"	0.15

### Applicator Brushes (Continued)

#### Acid, Solder Paste & Flux, Adhesive

Part #	Mfg #	Size	Wire	Price
17756	70240	#7	3/4"	1.11



### Epoxy

#### Pro Poxy™ 20

- Electrically non-conductive
- Withstands temperatures to 300°F
- Fast acting, single stick, steel-reinforced epoxy putty
- Makes steel-hard repairs in 20 minutes



Part #	Mfg #	Size	Price
16514	25515	4 oz	9.37

### Plastic Poxy™

- Fast-acting, single stick, patented combination of epoxy resin and hardener
- Bonds almost everything
- Mixes quickly and hardens in 40 minutes



Part #	Mfg #	Size	Price
34142	25531	4 oz	10.84

### All-Crafts Epoxy Tubes

- Two part Epoxy Waterproof Paste Epoxy Cement
- Bonds, Fills and Sets FAST in 12 minutes
- Resists gas, oil & salt water
- Sand, shape, drill, tap and paint
- Cures to rock hardness in 6 hours
- Can be applied underwater



Part #	Mfg #	Size	Price
16658	ET-12	13-1/2 oz	17.62

Chemicals

Prices & specifications are subject to change.

Our faucet parts counter is one of the largest in the Boston area with thousands of parts in stock!



## Chemicals



### BOSS® 635 Spray Adhesive

- BOSS® 635 Spray Adhesive combines a uniform misting spray pattern with super high solids to create a fast tacking and high bond strength product capable of handling virtually any light or heavy duty job.
- Bonds fabric, plastics, felt, cork, foam, insulation, paper, corrugated, wood, most metals and more.
- Multi-purpose
- Water resistant



Part #	Mfg #	Size	Price
15597	635	14oz	7.98

### Anti-Freeze

#### Cryo-Tek™ 100 Anti-Freeze

- Gives anti-freeze protection to -100°F when used undiluted
- Contains chemical ingredients to prevent corrosion
- Non-toxic



Part #	Mfg #	Size	Price
16529	35281	1 gal	23.91
16530	35284	5 gal	118.07
16531	35286	30 gal	708.40
39913	35287	55 gal	1281.26

#### Cryo-Tek™ 100/AL Anti-Freeze

- For aluminum heat exchanger heating and cooling systems
- Gives anti-freeze protection to -100°F when used undiluted
- Contains chemical ingredients to prevent corrosion
- Non-toxic



Part #	Mfg #	Size	Price
879940	35283	5 gal	132.10

#### Cryo-Tek™ Test Kit

- Checks level of propylene glycol and level of corrosion protection



Part #	Mfg #	Description	Price
16532	35271	Contains (10) Color-Coded Disposable Test Strips	21.00



### Boiler Additives

#### Squick Boiler Cleaners

- Cleans & protects
- Prevents formulation of insulating scale
- Protects metal & prevents priming or surging
- Maximizes efficiency & prolongs boiler life



Part #	Mfg #	Description	Price
124429	SK-24	5oz Can - For Steam Boilers	12.50



### Boiler and Heating Cleaners

#### Boiler and Heating System Cleaner

- Rust and scale remover and inhibitor
- Prevents foaming
- Recommended for use on all hydronic systems including those with rubber or plastic components



Part #	Mfg #	Size	Price
16520	35206	1 qt	20.67

#### Flip-Stick® Soot Destroyer

- For oil, gas, coal and wood heating units
- Patented formula requires no mixing or measuring
- Toss-in pack for clean, effective soot and creosote removal
- Has built-in "corrosion shield" to safeguard steel and stainless steel flue pipes
- Non-explosive



Part #	Mfg #	Size	Price
16521	35427	85 gram	4.58

Chemicals





## Chemicals

### Therma-Flow Internal Coil Cleaner

- Heavy duty liquid acid lime scale, mineral & rust remover
- For use on gas, oil and electric storage water heaters.



Part #	Mfg #	Size	Price
146562	N/A	1 gal	57.69



### Descalers

#### FLOW-AIDE System Descaler (Removes Scale, Lime, Rust)

- Flow-Aide™ biodegradable descaler quickly and safely dissolves water scale, lime, rust, and other water formed deposits, restoring efficiency to most all water based equipment.
- Non-corrosive
- Nontoxic
- Fully biodegradable\*
- Safe to handle
- Zero V.O.C.
- For use on: evaporators, heat exchangers, ice machines, potable water lines, water heaters, boilers, chillers, condensers, humidifiers, tanks.



Part #	Mfg #	Size	Price
934402	FLOW32	1 Quart	19.27

#### Descaler Flow Kit

- For use with tankless water heaters
- Includes:
  - FLOW32 system descaler
  - Pump
  - Bucket
  - Hoses



Part #	Mfg #	Description	Price
934403	FLOW	Kit includes: FLOW32, Pump, Bucket & Hoses	210.73



### Boiler/Heating System Stop-Leaks

#### Boiler Liquid

- For lasting repairs of cracked or leaking steam and hot water heating boilers
- Will not clog system or controls
- Withstands high pressures
- Cannot cause odors, priming or foaming
- Boiler cleaners will not affect repairs made with this product



Part #	Mfg #	Size	Price
16518	30115	1 qt	18.18

#### Boiler Solder

- Free flowing powder makes strong repairs on cracked steam or hot water heating boilers
- On contact with air, hardens into a powerful seal which expands and contracts with boiler metal
- Once set, will not be dislodged by boiler cleaners
- For use on all hydronic systems including those with rubber or plastic components



Part #	Mfg #	Size	Price
16517	30310	1 lb	21.49

### Radiator Specialty Company

#### Gunk® Boiler Seal

- Seals leaks in boilers, heating systems, steam & hot water systems, pipes & radiators



Part #	Mfg #	Size	Price
16645	B2-32	1 qt Liquid	6.51



## Chemicals

Chatham

### Silicone High Temp Caulk

- For indoor or outdoor use
- Permanently flexible
- -60°F to +450°F Water and weatherproof
- Insulates electrically and thermally room temperature vulcanizing



Part #	Mfg #	Description	Price
39892	RTV-106	10.3 oz, Red	12.77



### Firestopping Products

#### Metacaulk® 1000 Cartridge

- Water-based, single component, general purpose, fire-rated sealant and smoke seal for through-penetrations on both vertical and horizontal surfaces and construction joints
- Paintable
- VOC Compliant



Part #	Mfg #	Size	Price
169876	66302	10.3 oz	14.80

#### Metacaulk® 835 Cartridge

- One component, fire-rated elastomeric neutral, moisture cure silicone sealant for use in through-penetration firestops
- Use in Interior or exterior expansion, contraction, control joints and penetrations
- Can be used in systems where dynamic movement is expected



Part #	Mfg #	Size	Price
16625	66012	10.3 oz	16.54

### Caulk Gun

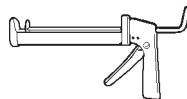

Part #	Description	Price
16481	Standard Barrel Style	6.21

### Plumbers Caulk™

- Siliconized acrylic makes flexible, durable, mildew-resistant, waterproof seal
- Interior or exterior applications
- Flows easily, does not harden in tube or cartridge, does not crumble & resists shrinkage
- Easy clean-up with soap water



Part #	Mfg #	Size	Color	Price
16516	25620	5.5 oz	Clear	5.62

### Sealants

#### Plastic Seal™

- Excellent lead substitute for caulking cast iron soil pipe joints
- Single component polyurethane sealant cures rapidly to a durable, flexible, waterproof seal
- Does not contain any volatile organic compounds



Part #	Mfg #	Size	Price
146898	25215	10.3 oz	16.47

### Roof and Flashing Sealant

- Special bituminous composition with superior adhesion under the most severe weather conditions
- Heavy, paste-like consistency, easily applied with trowel or putty knife
- Adheres to wet/moist surfaces - can be applied in rain
- Forms durable, flexible, weatherproof coating



Part #	Mfg #	Size	Price
16512	25405	1 qt	16.33

Chemicals



## Chemicals

### Quick Cure Polyurethane Foam Sealant

- A fast and easy, high-yield means to seal cracks and gaps. Patented all-direction dispensing easily maneuvers tight spots. Reusable dispensing means you can restart the can later.
- Yield (linear feet), 12 oz.
- 1/4" bead - 918
- 3/8" bead - 408
- Density - 1.75+/- .25 lbs./cu.ft.
- Max. Service Temp for Cured Foam - 240°F (116°C)



Part #	Mfg #	Size	Price
15599	S30012	12 oz	12.68

### Putty Sta Put®

- Flexible, stretchable, plastic putty will not harden crumble, crack or shrink
- Will not stick to hands



Part #	Mfg #	Size	Price
16507	25101	14 oz	2.71
16508	25103	3 lb	8.08
16509	25105	5 lb	12.64

### Sta Put® Ultra™

- Oil-free & can be used without pre-treatment
- Safe for most plumbing fixtures & surfaces including stone, marble, granite, plastics, rubber, fiberglass & grout
- Will not melt, rot, crumble, dry out or shrink



Part #	Mfg.#	Size	Price
890746	25171	14 oz	6.29

### Furnace/Stove Cements

#### Furnace/Stove Cement

- Contains no asbestos
- High temperature compound for setting up furnaces, ranges and stoves
- Makes joints acid-proof, gas-proof and fireproof



Part #	Mfg #	Size	Price
16523	35515	1/2 gal	17.40

Prices & specifications are subject to change.

You can check stock availability, pricing and place orders online at [www.MetPipe.com](http://www.MetPipe.com).



### For Heat's Sake Retort/Furnace Cement

- High temperature refractory and retort
- For mortar facing, caulking or coating
- Exclusive Clean 'n Friendly™ formula of high purity ingredients



Part #	Mfg #	Size	Price
16524	35610	1 gal	35.29



## Join our e-mail newsletter!

Receive special deals and promotions, new product announcements, contests and more in your inbox every month!

## MSDS Safety Sheets

Download MSDS sheets online at  
**[www.MetPipe.com!](http://www.MetPipe.com)**



## Chemicals



### Hand Cleaners

#### Hercules for Hands™ Tub

- Ready-to-use, pre-saturated towels remove plastic pipe cement, grease and grime, tar and ink from users' hands
- Contains aloe, lanolin, and vitamin E
- Won't shred - leaves no residue



Part #	Mfg #	Size	Description	Price
50203	45333	Large	70 Towels per Tub	28.20

#### Hercules for Hands™ Lotion Hand Cleaner with Pumice

- Professional strength cleaner
- Works without water
- Contains aloe vera, lanolin, vitamin E and fine grain pumice
- No harsh solvents or chemicals

Lemon



Part #	Mfg #	Size	Description	Price
16541	45314	15 oz	Lemon	8.87
16542	45325	16 oz	Unscented	8.87

### Radiator Specialty Company

#### Gunk® Green Concentrated Cleaner

- Removes grease & grime from machinery when used at full strength yet still effective for glass & crystal when diluted
- Non-toxic, biodegradable and non-corrosive



Part #	Mfg #	Size	Price
16639	GGC33	33 oz	3.95



#### Bathroom & Kitchen Cleaning/Care

##### KRC-7® Ultra Foaming

- Easy to use trigger spray formula



Part #	Mfg #	Description	Price
16713	KRC-7	16 oz Spray Bottle	9.04



### SaniGuard Sanitizing Sprays

- SaniGuard sanitizing products are EPA registered, patented, and have been proven to kill 99.99% of Influenza and 39 other various germs, bacteria, fungus, and viruses in mere seconds; including: MRSA, Ringworm, HIV, E-Coli, Salmonella, and Herpes.
- Safe for food contact and other non-porous surfaces including fabrics and electronics!



#### Total Release Fogger

- The World's first patented and extensively tested product that enables you to sanitize entire rooms in just minutes with the same kill-on-contact power of the conventional SaniGuard® sprays.
- SaniGuard® Total Release Fogger is the world's first DRY-ON-CONTACT Sanitizing Fogger & Deodorizer.

Part #	Mfg #	Description	Price
924529	TR3	3oz Can - Single Room	12.00
924528	TR8	8oz Can - Large Room (up to 625 sq ft)	17.04

#### Dry-on-Contact Surface Spray

- Use this spray in bathrooms, offices, schools, and hotels. Ideal for treating hard to clean HOT SPOTS such as phones, faxes, shared office equipment, light switches, faucets, toilet seats, door knobs, drinking fountains, keyboards and computer mouse, break room tables, etc.

Part #	Mfg #	Description	Price
924526	S10	10oz Spray Can	16.28



### Drain and Waste System Cleaners

#### Wham®

- Environmentally safe and biodegradable, non-caustic and non-acid
- Dissolves & controls grease, slime, soap detergents & odors in waste systems
- Harmless to digestive bacteria
- Restores porosity & maximum drainage to grease-clogged soil



Part #	Mfg #	Size	Price
16499	20110	1 qt	32.93
16500	20115	1 gal	100.64

Prices & specifications are subject to change.

Chemicals



## Chemicals



### Clobber®

**For Professional Use Only. Not for Retail Sale.**

- Fastest method for clearing emergency waste line stoppages
- No mechanical equipment needed
- Rapidly disintegrates paper, rags, sanitary napkins, food scraps & all organic matter, melts ice & liquefies grease
- Special inhibitors prevent corrosion of cast iron, copper, and steel piping
- Jugs with child-resistant caps packed in plastic bags



Part #	Mfg #	Size	Price
16501	20205	1 qt	19.45
16502	20211	1/2 gal	33.66

### Sizzle® Cleaner

**For Professional Use Only. Not for Retail Sale.**

- Removes lime, rust, scale, concrete, hard mineral deposits and insoluble salts from water systems, waste lines, humidifiers, heating, processing & air conditioning equipment
- Dissolves urinary salts
- Special inhibitors make it safe for iron, steel, copper, brass, bronze, lead & plastic
- Child-resistant caps



Part #	Mfg #	Size	Price
147357	20305	1 qt	15.76

### R-D Root Destroyer

- Clears and prevents root-blocked sewer lines
- Non-caustic & non-acid; safe to use in lines leading to septic tanks
- Works only on live roots - will not harm trees or shrubs



Part #	Mfg #	Size	Price
16506	20602	2 lb	32.11

### Double Agent® Cleaner

- Fastest acting non-acid liquid drain opener; clears most drains within minutes
- Easy pre-measured 2-step, 1-shot operation
- Harmless to plumbing & no messy bail outs



Part #	Mfg #	Size	Price
16505	21310	16 oz	6.96

### GLUG™ Crystals

- Non-acid crystals clear sluggish drains and prevent clogging
- Harmless to metal and plastic pipe, valves and fittings
- Leaves no offensive after-odor



Part #	Mfg #	Size	Price
16504	20410	20 oz	11.51



### Floweazy Drain Cleaners

- Organic digester; biodegradable
- Dissolves grease, hair, sanitary napkins, sludge, soap and paper
- Removes lime scale & rust deposits
- Safe for septic tanks and pipes
- Ground transport only



Part #	Mfg #	Size	Price
890136	S95-701	16 oz	10.23
242120	S95-703	1 qt	18.41
861526	S95-704	1/2 gal	27.70

### Everprime Floor Drain Cleaner

- Simply add it and forget it!
- Everprime is great for removing odors from floor drains in restrooms, warehouses, public areas, etc.
- Simply add 1 gallon of water and 3 ounces of Everprime into the floor drain- and forget it!



Part #	Mfg #	Size	Price
858340	1514	1 qt	25.00

## MSDS Safety Sheets

Download MSDS sheets online at  
**[www.MetPipe.com!](http://www.MetPipe.com)**



## Chemicals

### Green Blaster Drain Opener

- Dry granular drain opener for clearing grease, hair and other organic matter from drains
- Will not harm chrome, polished brass or plastic; safe for septic tanks



Part #	Mfg #	Description	Price
16718	GB1	1 lb Plastic Container	9.42
16719	GB2	2 lb Plastic Container	17.42

### RECTORSEAL

### Leak Locators Better Bubble™

- From 0° to 250°F



Part #	Mfg #	Size	Price
229072	65554	8 oz	4.07
229075	65432	32 oz	10.75
229076	65273	1 gal	30.77

### Rectorseek™ Low-Temp Leak Locator

- Red color
- From -35° to 200°F



Part #	Mfg #	Description	Price
16618	61554	8oz with Dauber Top	6.94
16620	61434	16oz - Trigger Spray Sold Separately	17.87
16622	61273	1 Gallon	32.42

## MSDS Safety Sheets

Download MSDS sheets online at  
[www.MetPipe.com!](http://www.MetPipe.com)

### Radiator Specialty Company

### Lubricants & Penetrants

#### Liquid Wrench® Penetrating Oil

- Loosens rusted bolts, nuts & parts



Part #	Mfg #	Size	Price
16641	L112	11 oz	7.05

#### Liquid Wrench® Non-Flammable Lubricating & Penetrating Oil with Cerflon®

- Loosens rusted bolts, nuts & parts



Part #	Mfg #	Size	Price
16643	L312	11 oz	3.50

#### Liquid Wrench® Silicone Spray

- Compatible with all metals, rubber, plastic & wood
- High viscosity formula eliminates squeaks and lubricates all kinds of household and mechanical equipment



Part #	Mfg #	Size	Price
16648	M9-14	14 oz	2.81

#### Liquid Wrench® White Lithium Grease

- Sprays on as liquid, sets up as lubricating grease that will not melt, wash off or freeze



Part #	Mfg #	Size	Price
16647	L616	14 oz	4.13



## Chemicals

### WD-40 with Smart Straw

- Now you can use WD-40® to protect and lubricate thousands upon thousands of items – without ever losing the straw again!
- New Smart Straw features a permanently attached straw that sprays two ways. Simply flip it up for a precision stream and down for a regular spray action.



Part #	Mfg #	Description	Price
113415	WD-40	8 oz	7.63

### Plumber's Heat-Pruf Grease

- Waterproof & heat-proof lubricating product



Part #	Mfg #	Size	Pkg Qty	Price
16596	GR-1	2.5 oz	12	2.92



### Penetrating Oil

#### FREE ALL® Industrial Strength Deep Penetrating Oil

- Actually eats rust
- Spreads deep into rusted or frozen parts, freeing them in seconds



Part #	Mfg #	Description	Price
861233	FA12	12 oz Aerosol	7.90



### Lubricants

#### Cutting Oil - Clear

- Recommended for hand-threading applications
- High quality mineral oils with sulfur base
- Will not stain brass or copper
- Contains no nitrosamines



Part #	Mfg #	Size	Price
16526	40115	1 qt	18.56

### Lubricants (Continued)

#### Cutting Oil - Clear

Part #	Mfg #	Size	Price
16528	40120	1 gal	43.18

#### Cutting Oil - Dark

- For high speed machine-threading requirements
- High quality mineral oils with sulfur-lard base
- Contains no nitrosamines



Part #	Mfg #	Size	Price
16525	40215	1 qt	18.56
16527	40220	1 gal	43.18



### Anti-Seize & Lubricating Compound

#### Regular Grade

- Keeps parts working longer with less wear
- Enables faster disassembly when repairs are needed - even after exposure to high temperatures
- Protects against carbon fusion
- Resists alkaline solutions, most chemical & acid vapors, road salt, steam, salt water, iodized water



Part #	Mfg #	Description	Price
16589	NSBT-8	8 oz Brush-Top Can	15.17
16587	NSA-16	16 oz Aerosol Can	20.47
16588	NS-160	1 lb Flat-Top Can	22.39



### Nickel Anti-Seize Compound

- Nickel base anti-seize lubricant and thread sealant
- 2600°F Service rating

Part #	Mfg #	Description	Price
219436	NI16	1 lb Brush Top Can	44.78

Prices & specifications are subject to change.

Our state of the art pipe shop offers cutting, threading, grooving and make-ons up to 36in!



# Chemicals

## Reach Lube Oil

- For lubricating electrical motors, tools, hinges, etc
- Cleans and preserves metal
- Non-detergent
- Pull-out spout

Part #	Mfg #	Description	Price
215493	LO4	4 oz Plastic Bottle	3.91



## "Duck Butter" Pipe Lubricant



Part #	Mfg #	Size	Price
221397	L95-200	1 qt	9.86



## Thread Sealants TFE Pipe Joint Tape

- Economical, low density grade
- Weather resistant, flexible, non-stick, non-flammable, low dielectric constant chemically inert and usable at low temperatures



Part #	Mfg #	Size	Price
16566	15162	1/2" x 260"	0.62
16567	15164	1/2" x 520"	0.71
41806	15176	3/4" x 520"	1.74

## Tape Dope®

- Non-hardening and non-toxic
- Clean, fast, high density, high quality PTFE tape



Part #	Mfg #	Size	Price
16485	15111	1/4" x 200"	7.36
16486	15122	1/2" x 200"	6.40
16487	15124	1/2" x 500"	8.55
16488	15127	1/2" x 750"	11.13
16489	15136	3/4" x 500"	17.71

## Blue Monster™ PTFE Thread Seal Tape

- Blue Monster is rugged, not flimsy like most thread seal tapes on the market. Blue Monster has not been stretched during the manufacturing process, so it is thicker and creates a more effective seal with less tape, and no need for pipe dope.
- Composition: 99.6% PTFE < 0.4%
- Pigment Color: Blue
- Length: 1429"
- Thickness: 0.0035" +/- 10%
- Density: 0.8g/cm3
- Elongation: >100%
- Tensile Strength: 15N / mm2



Part #	Mfg #	Size	Price
929255	70885	1/2" x 1429"	4.33
929257	70886	3/4" x 1429"	5.90
929258	70887	1" x 1429"	7.58

## X-TRU-COAT Pipe Wrap Tape

- The Polyken #932 is a cold applied tape coating system designed for the corrosion protection of field joints, fittings, and specialty piping.
- Super high tack adhesive
- Conformable to irregular shapes
- Hand or machine application
- Established in-ground history
- Complies with AWWA C-209 Standard



Part #	Mfg #	Size	Price
110738	932-35	Yellow tape	19.27



## PTFE Thread Sealant Tape

### Oxygen (Green) Full-Density Teflon® Thread Seal Tape TF5-25

- 99.6% Virgin PTFE Teflon
- For oxygen lines, systems & other flammable environments & for most liquid, oil & chemical installations
- 3000 psi



Part #	Mfg #	Description	Price
878938	70850	1/2" x 260" Roll 10/Pk	6.10

Chemicals





## Pipe Sealants



### 3-Wrap Gas (Yellow) Full-Density Teflon® Thread Seal Tape TF5-20

- 100% Virgin PTFE Teflon
- For ferrous & non-ferrous threaded fittings in gas pipelines, cylinders, containers & storage vessels
- -450°F to +550°F
- 0 to 5000 psi



Part #	Mfg #	Description	Price
226057	70830	3/4" x 260" Roll 6/Pk	5.68



### Thread Sealants

#### Pro Dope® Compound

- Lead-free, no-drip, no-spill, non-toxic pipe joint compound; wipes clean from hands
- No mixing - will not harden - uniform throughout can
- Lubricates while forming tight pressure seal
- Inhibits rust and corrosion



Part #	Mfg #	Size	Price
16494	15420	1/2 pt	5.92
16495	15427	1 pt	9.58

#### Grip™ Pipe Joint

- Lead-free, all-purpose, leak-proof, non-hardening pipe joint and gasket seal
- Brushable semi-liquid forms tough, pliable film on joints, valves, flanges and gaskets



Part #	Mfg #	Size	Price
16496	15515	1/2 pt	13.20

#### Real-Tuff™ Sealant

- Lead-free, multi-purpose, heavy duty PTFE paste thread sealant
- Non-toxic and non-separating
- Positive, leak-proof seal on all piping material; for all liquids & gases EXCEPT oxygen



Part #	Mfg #	Size	Price
16497	15620	1/2 pt	16.82
16498	15625	1 pt	26.95

### Megaloc™ Sealant

- Lead-free, blue, grit-free high performance thread sealant
- Leak-proof hydraulic resistance to 12,000 psi
- Withstands gas pressure to 2,600 psi
- Temperature range: -50° to +400°F
- Odorless, non-separating & non-hazardous; wipes clean from hands with a dry rag
- Never hardens, cracks or becomes brittle



Part #	Mfg #	Size	Price
172850	15806	8 oz	16.64
92538	15808	16 oz	26.89



### Pipe Thread Sealants

#### Rectorseal® No. 5®

- Yellow color
- Multipurpose, soft-set



Part #	Mfg #	Description	Price
16610	25551	1/2 pt Brush Top	9.94
16611	25431	1 pt Brush Top	15.60
16612	25300	1 qt Brush Top	30.31

#### Rectorseal® No. 7

- Black color
- For corrosive chemicals



Part #	Mfg #	Description	Price
152171	17432	1 pt Brush Top	39.87

#### Rectorseal® No. 100 Virgin®

- White color
- Industrial grade Teflon® sealant



Part #	Mfg #	Description	Price
16614	22551	1/2 pt Brush Top	20.74



## Chemicals

### Rectorseal® T Plus 2®

- White color
- Contains Teflon® plus synthetic fibers



Part #	Mfg #	Description	Price
16630	23551	1/2 pt Brush Top	10.45

### Rectorseal® Tru-Blu™

- Blue color
- Contains Teflon® for high vibration environments



Part #	Mfg #	Description	Price
139606	31431	1 pt Brush Top	14.82



### Pipe Seal with PTFE

#### Gasoiola® Soft-Set Pipe Seal with PTFE

- General purpose, use on all metals & most plastics
- Non-toxic & non-separating
- Remains pliable in cold temperatures
- Not for use with oxygen systems



Part #	Mfg #	Description	Price
236493	SS08	8 oz Can w/Brush Top	14.12
229487	SS16	16 oz Can w/Brush Top	23.54
236492	SS32	32 oz Can w/Brush Top	38.28



### Pipe Compounds

#### Blue Magic Thread Compound

- All purpose non-seizing industrial grade pipe thread compound
- For metal and plastic threaded connections



Part #	Mfg #	Description	Price
16714	IG8	8 oz Brush Top Can	11.36
16715	IG16	1 pt Brush Top Can	18.80
786454	IG32	1 qt Brush Top Can	33.93

### Select-Unyte Thread Compound

- Soft-set white all purpose PTFE paste
- For use on plastic and metal threaded system carrying air, steam, petroleum, water, gases and many chemicals



Part #	Mfg #	Description	Price
16716	TF8	8 oz Brush Top Can	12.69
16717	TF16	1 pt Brush Top Can	20.93

### X-Pando Pipe Joint Compound

- When properly applied, provides tight, leak proof joints on most kinds of pipe.
- The expansion fills defective threads and flange faces.
- Use as a repair cement for sand holes in pipe, boiler tubes or iron castings and for repairing seams and joints.
- Can also be used for anchoring studs and bolts in a variety of surfaces.



Part #	Mfg #	Description	Price
16720	N/A	14 oz	12.00



### Plastic Pipe Cement Daubers

- Shaft extends to the bottom of the can - no wasted cement - no tipping of can



Part #	Mfg #	Size	Fits	Price
110552	50245	1-1/2" dia	1/2 pt, 1 pt or 1 qt	1.04

### Plastic Pipe Cements

#### PVC Cement Clear (Blue Label)

- Medium body, medium set
- For PVC Types I & II, potable water, DWV, and SW pipe and fittings up to 6" diameter. Schedules 40 and 80.
- Meets ASTM D2564.
- Cement color: clear
- VOC Level: 510 gpl



Part #	Mfg #	Size	Price
914831	60013	1/2 pt	6.90

Chemicals



## Chemicals



### Plastic Pipe Cements (Continued)

#### PVC Cement Clear (Blue Label)

Part #	Mfg #	Size	Price
914832	60015	1 pt	10.87
914833	60020	1 qt	19.08

#### PVC Cement Clear (Orange Label)

- Regular body, fast set
- For PVC Types I & II potable water, DWV & SW pipe & fittings up to 6" diameter Sch 40
- Withstands temperatures to -10°
- Conforms to ASTM D2564
- Low VOC cement



Part #	Mfg #	Size	Price
914838	60145	1 pt	13.47
914839	60148	1 qt	22.62

#### PVC Cement Clear (Tan Label)

- Heavy body, slow set
- For PVC Types I & II potable water, DWV & SW pipe & fittings up to 15" diameter Sch 40 & 80
- Conforms to ASTM D2564



Part #	Mfg #	Size	Price
16552	60160	1 pt	15.21
16553	60165	1 qt	26.38

#### PVC Cement Clear (Gray Label)

- Heavy body, slow set
- For PVC Types I & II potable water, DWV & SW pipe and fittings up to 15" diameter Sch 40 & 80
- Conforms to ASTM D2564
- Low VOC cement



Part #	Mfg #	Size	Price
914836	60215	1 pt	14.16
914837	60220	1 qt	24.78

### CPVC Plastic Pipe Cement (Orange Label)

- Original
- For CPVC 23447-B (ASTM #D1784) potable water pipe & fittings up to 6" dia
- Conforms to ASTM D2846
- Low VOC cement



Part #	Mfg #	Size	Price
914840	60315	1 pt	19.27
914841	60320	1 qt	34.01

### CPVC Gold Plastic Pipe Cement

- Low VOC cement
- Meets ASTM F493



Part #	Mfg #	Size	Price
889171	60358	1/2 pt	11.06
889169	60360	1 pt	19.42

### Plastic Pipe Primers PVC & CPVC Purple Primer (Purple Label)

- Softens & prepares surfaces of PVC & CPVC before applying solvent cements



Part #	Mfg #	Size	Price
16562	60415	1 pt	13.31

### PVC Purple Primer (Purple Label)

- Softens & prepares surfaces of all sizes & schedules before applying solvent cements
- Conforms to ASTM F656



Part #	Mfg #	Size	Price
16559	60490	1 qt	22.67

### PVC Clear Primer (Red Label)

- Softens & prepares surface of PVC pipe & fittings



Part #	Mfg #	Size	Price
16556	60458	1/2 pt	7.42
16557	60460	1 pt	12.39
16558	60465	1 qt	20.49

Prices & specifications are subject to change.

Metropolitan Pipe offers Vendor Managed Inventory - never run out of that part again!



## Chemicals

### Permatex® Sealants

#### Form-A-Gasket No. 1®

- Improves gasket seal on close fitting parts
- Slow drying, pliable setting
- Withstands pressures to 5000 psi
- Temperature range: -65° to 400°F



Part #	Mfg #	Description	Price
232869	1011004	3 oz Tube	5.90

#### Form-A-Gasket No. 2®

- Improves gasket seal on non-rigid, vibrating ass
- Slow drying, flexible setting
- Withstands pressures to 5000 psi
- Temperature range: -65° to 400°F



Part #	Mfg #	Description	Price
232870	1011010	3 oz Tube	7.37



### Asphalt Paint

#### Black Magic™

- Concentrated, fast drying, high-gloss black
- Extra-high concentration of gilsonite for permanent waterproof & rust-proof protection



Part #	Mfg #	Description	Price
16538	45210	1 gal, Weather Resistant	65.82



### Spray Paint

#### Krylon® (5-Ball) Interior-Exterior Paint

- Krylon® Industrial (5-Ball) Interior-Exterior Paint is the #1 brand in spray paints. These paints are specifically formulated for industrial maintenance and touch-up applications. Performance is exceptional and they dry in 12 minutes or less.
- The most asked-for spray paint in the industrial marketplace
- No runs, no drips no errors!™ formula
- Superior performance, both indoors and outdoors
- OC-compliant acrylic lacquer formula, free of lead hazards
- Hard, protective, durable finish
- Tough, high-gloss finish



Part #	Mfg #	Color	Size	Price
905988	K01613	Semi-flat Black	16oz	7.19
905985	K09242	HAMM-R Gray	16oz	10.32
905989	K01508	Semi-gloss White	16oz	6.83
905990	K01406	Silver Metallic	16oz	6.83
905992	K01813	OSHA Yellow	16oz	6.83
905987	K02101	Red	16oz	6.83
905991	K02203	Copper Metallic	16oz	11.67



### Cold Galvanizing Spray

#### Rectorseal® Cold Galvanizing Spray

- Gray color
- Hot dip quality



Part #	Mfg #	Description	Price
16629	86625	16 oz Aerosol	8.85

Chemicals



## Chemicals



### Cool Gel® Heat Barrier Spray

- Unique gelled formula sticks to surfaces without dripping or running off.
- Clear, non-staining gel leaves no residue eliminating clean-up.
- Safe, non-toxic, harmless to skin and odorless.
- Convenient trigger spray
- Applications:
  - Helps protect rubber, plastic, distortion, painted, and finished surfaces during soldering, brazing or welding
  - Reduces danger of fire to surrounding surfaces



Part #	Mfg #	Size	Price
934863	11513	1 Pint	16.10
905156	11509	1 Quart	23.04

## RECTORSEAL

### Soldering Flux

#### Nokorode® 95/5 Pre-Tinning

- Lead free
- Clean, pre-tins and fluxes
- Low scorching, burning, corrosion & spattering



Part #	Mfg #	Size	Price
16595	14115	8 oz	8.42

#### Nokorode® Soldering Flux

- Will not freeze or decompose
- Odorless and lead-free
- Recommended for use on all solder alloys including 95/5 and all lead-free solders



14020

14030

Part #	Mfg #	Size	Price
16592	14000	1.7 oz	1.67
16593	14020	8 oz	6.99
16594	14030	1 lb	9.07

### Utility Paste Soldering Flux

- Removes oxidation and prepares copper, lead, brass, tin, stainless steel, cast and wrought iron for the proper bonding of solder to metal assuring leak-tight joints
- Recommended for all soft solder work, including 95/5
- Meets federal specification 0-F-506



Part #	Mfg #	Description	Price
16655	14-216	1/2 LB	9.01
16656	14-220	1 LB	14.09

### Water Soluble Paste Soldering Flux #B-813

- Safe for use on potable water
- Lead free
- Non-acid
- Will not run or separate in warm weather
- Easy to use, brushable



Part #	Mfg #	Description	Price
206210	14-236	1/2 LB	11.08



### Clean-Fit Products

#### Solder Paste Flux

- For general copper pipe soldering, fire sprinkler systems and potable water applications
- Non-toxic and lead-free



Part #	Mfg #	Description	Price
176519	70699	1 lb Tub, Water-Soluble Solder Paste	4.49

## MSDS Safety Sheets

Download MSDS sheets online at  
[www.MetPipe.com!](http://www.MetPipe.com)



**Royal / Regal Flushometers**

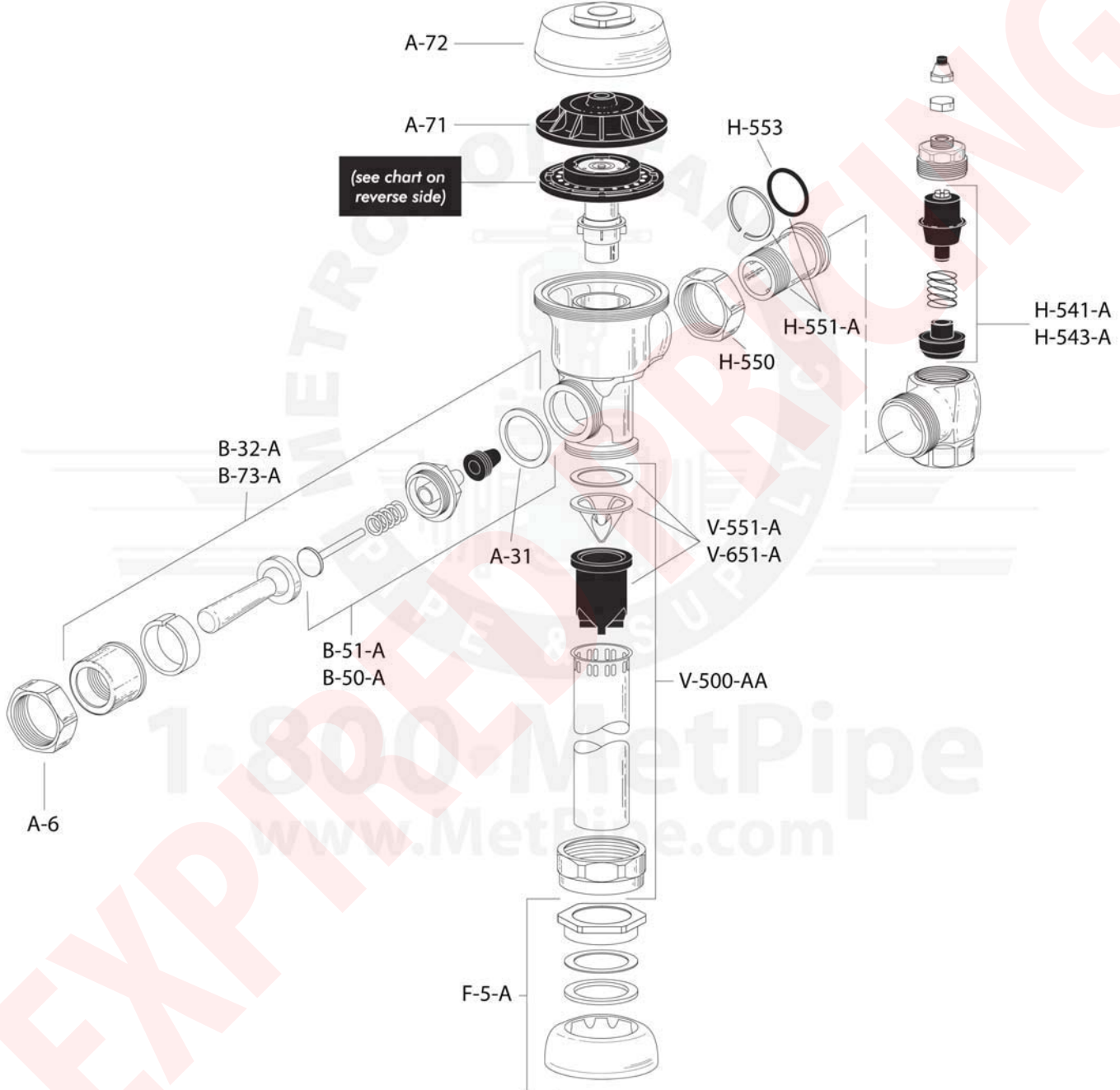

Repair Parts

Part #	Mfg #	Description	Price
25321	A-72	Chrome Plated Cover	23.84
25319	A-71	Inside Cover	7.34
25342	B-32-A	Chrome Plated Handle Assembly	13.66
46469	B-73-A	Chrome Plated Triple Seal Handle Assembly	18.15
25479	B-50-A	Handle Repair Kit	3.63
206518	B-51-A	Triple Seal Handle Repair Kit	6.67
25389	H-550	Chrome Plated Stop Coupling	6.28

Prices & specifications are subject to change.



**Royal / Regal Flushometers (Continued)**

Part #	Mfg #	Description	Price
Call	H-551-A	Chrome Plated Adjustable Tailpeice - <i>Multiple Sizes Available</i>	Call
25513	H-553	O-Rings	0.92
Call	V-500-AA	Chrome Plated Vacuum Breaker - <i>Multiple Sizes Available</i>	Call
25535	V-551-A	Vacuum Breaker Repair Kit	3.21
138807	V-651-A	High Back Pressure Vacuum Breaker Repair Kit	3.40
25515	H-541-A	Control Stop Repair Kit - 1in	10.59
25517	H-543-A	Control Stop Repair Kit - 3/4in	10.59
Call	F-5-A	Chrome Plated Spud Coupling Assembly - <i>Multiple Sizes Available</i>	Call
25315	A-6	Chrome Plated Handle Coupling	5.87
25317	A-31	Handle Gasket	0.55
Call	F-5-A	Chrome Plated Spud Coupling Assembly - <i>Multiple Sizes Available</i>	Call

**Royal / Regal Diaphragms**

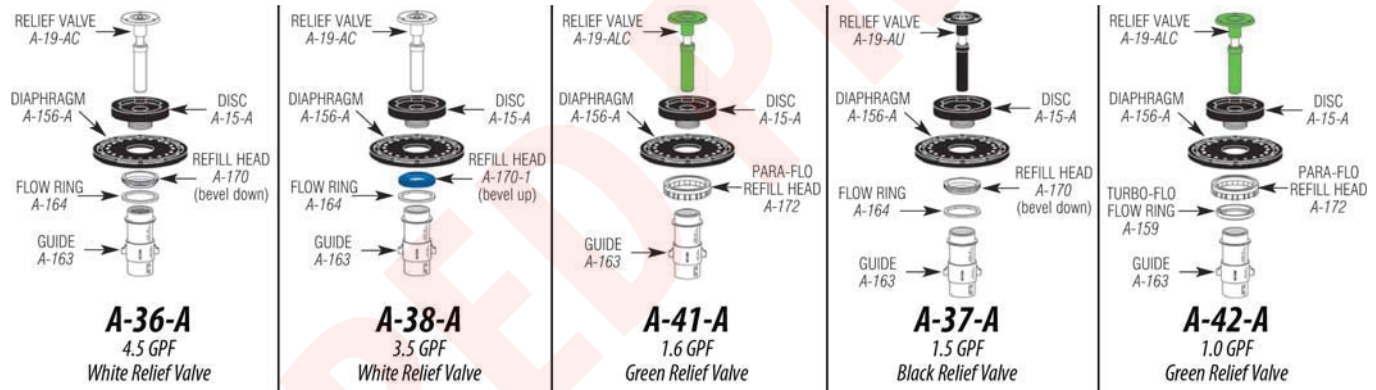

**Closets** — Diaphragm Inside Parts Kits

**Urinals** — Diaphragm Inside Parts Kits

Part #	Mfg #	Description	Price
25466	A-36-A	Diaphragm Kit - Closet - 4.5 GPF	21.23
25468	A-38-A	Diaphragm Kit - Closet - 3.5 GPF	21.23
25471	A-41-A	Diaphragm Kit - Closet - 1.6 GPF	29.66
25467	A-37-A	Diaphragm Kit - Urinal - 1.5 GPF	21.23
25472	A-42-A	Diaphragm Kit - Urinal - 1.0 GPF	29.66
25312	A-19-AC	Relief Valve (Closet)	5.73
25313	A-19-AU	Relief Valve (Urinal)	5.73
25322	A-156-A	Diaphragm	5.73
25316	A-15-A	Disc	4.86
25323	A-163	Guide	4.68

Repair Parts

Prices & specifications are subject to change.

Our office hours are 7am to 4:30pm and counter hours 6am to 4:30pm Monday through Friday.



**G2 Optima Plus (Sensor Operated Flushometers)**

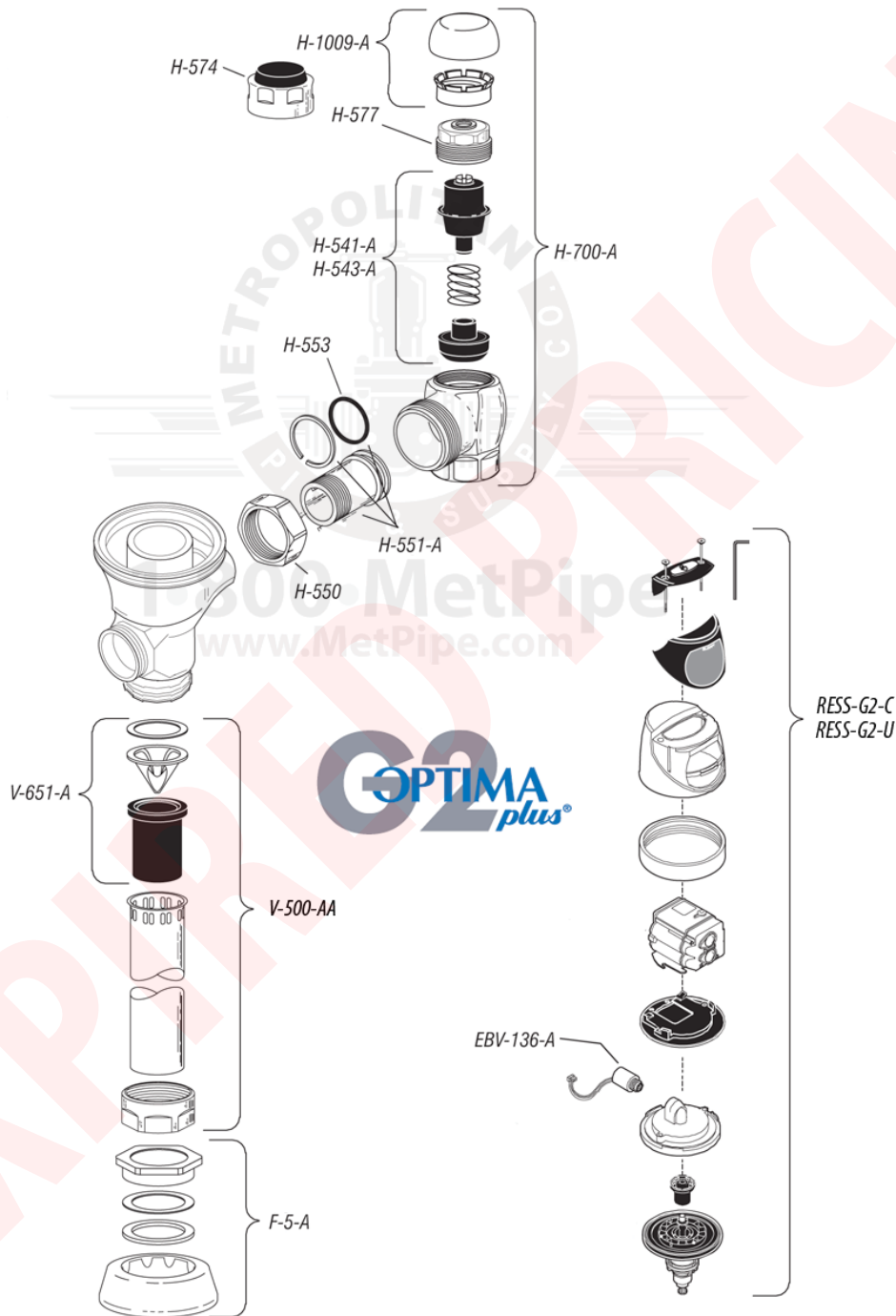

**G2 Retrofit Kits**

Part #	Mfg #	Description	Price
226471	RESS-G2-C	Closet retrofit kit 3325400 for 110/111 flush valve	308.24
226469	RESS-G2-U	Urinal retrofit kit 3325402 for 186 flush valve	308.24

Repair Parts





### G2 Optima Plus - Replacement Parts

Part #	Mfg #	Description	Price
39333	H-1009-A	Vandal Resistant Control Stop Cap Assembly	10.36
25519	H-574	1" Decorative Stop Cap	11.74
25399	H-577	CP Bonnet	8.30
25515	H-541-A	Control Stop Repair Kit	10.59
25517	H-543-A	Control Stop Repair Kit	10.59
138796	H-700-A	Chrome Plated 3/4" Screwdriver Bak-Chek® Stop	60.87
25513	H-553	O-Rings	0.92
Call	H-551-A	Chrome Plated Adjustable Tailpeice - <i>Multiple Sizes Available</i>	Call
25389	H-550	Chrome Plated Stop Coupling	6.28
138807	V-651-A	Vacuum Breaker Repair Kit	3.40
Call	F-5-A	Chrome Plated Spud Coupling Assembly - <i>Multiple Sizes Available</i>	Call
Call	V-500-AA	Chrome Plated Vacuum Breaker - <i>Multiple Sizes Available</i>	Call
791988	EBV-136-A	Solenoid (For G2 Modules only)	26.95

## Repair Parts

Faucet stems, replacement handles, nuts & bolts - we have it all! Our parts counter is one of the largest in Boston!



**Delta Models: 100, 110, 120, 400, 420**

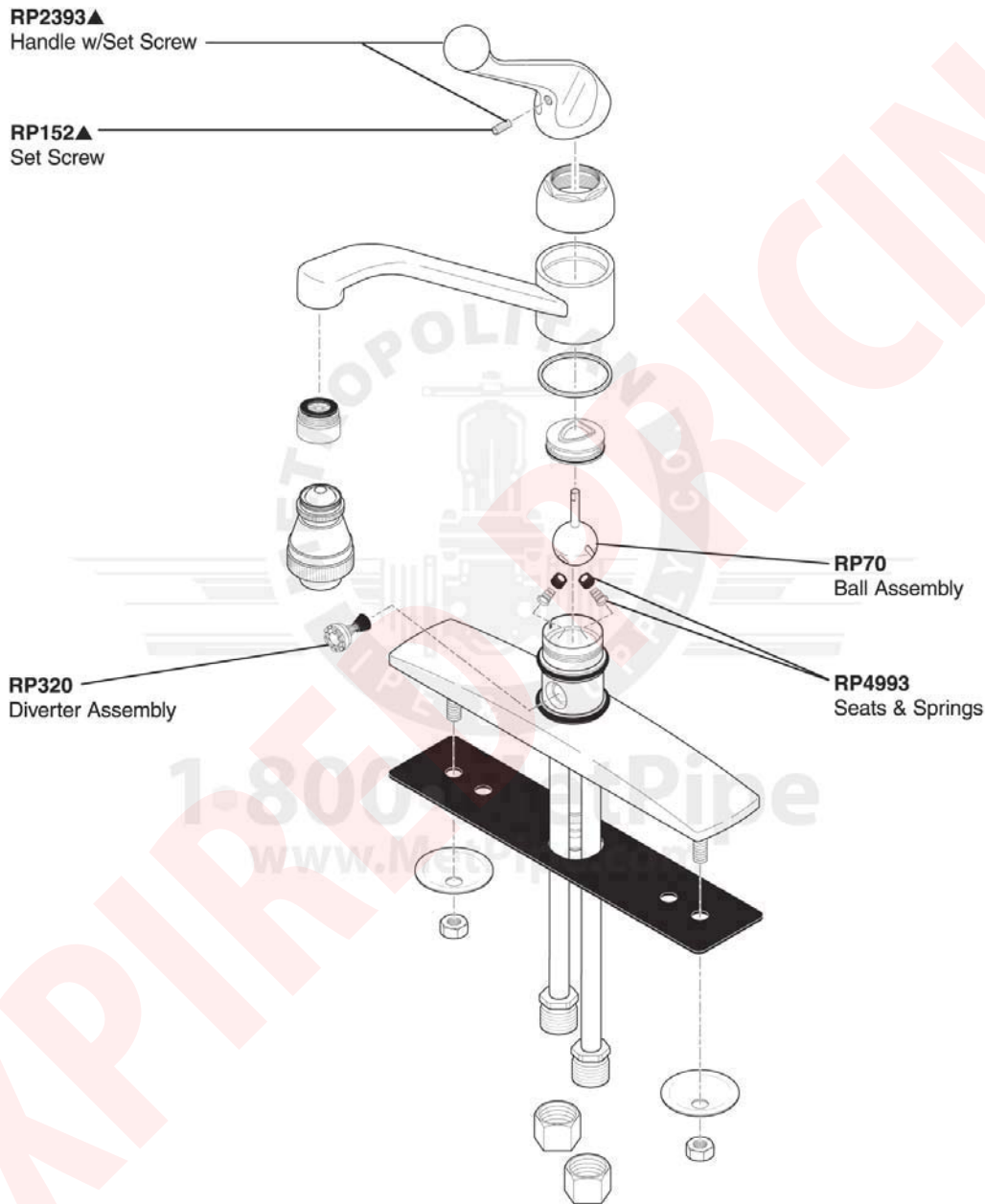

Repair Parts

Part #	Mfg #	Description	Price
21576	RP2393	Handle w/Set Screw	14.34
21554	RP152	Set Screw	3.76
21560	RP320	Diverter Assembly	7.03
21552	RP70	Ball Assembly	12.46
21592	RP4993	Seats & Springs	4.24
21584	RP3614	Internal Repair Kit; Includes: Ball Assembly, Seats & Springs, Gaskets	9.84

Prices & specifications are subject to change.



Delta Models: 2100, 2102, 2400, 2402

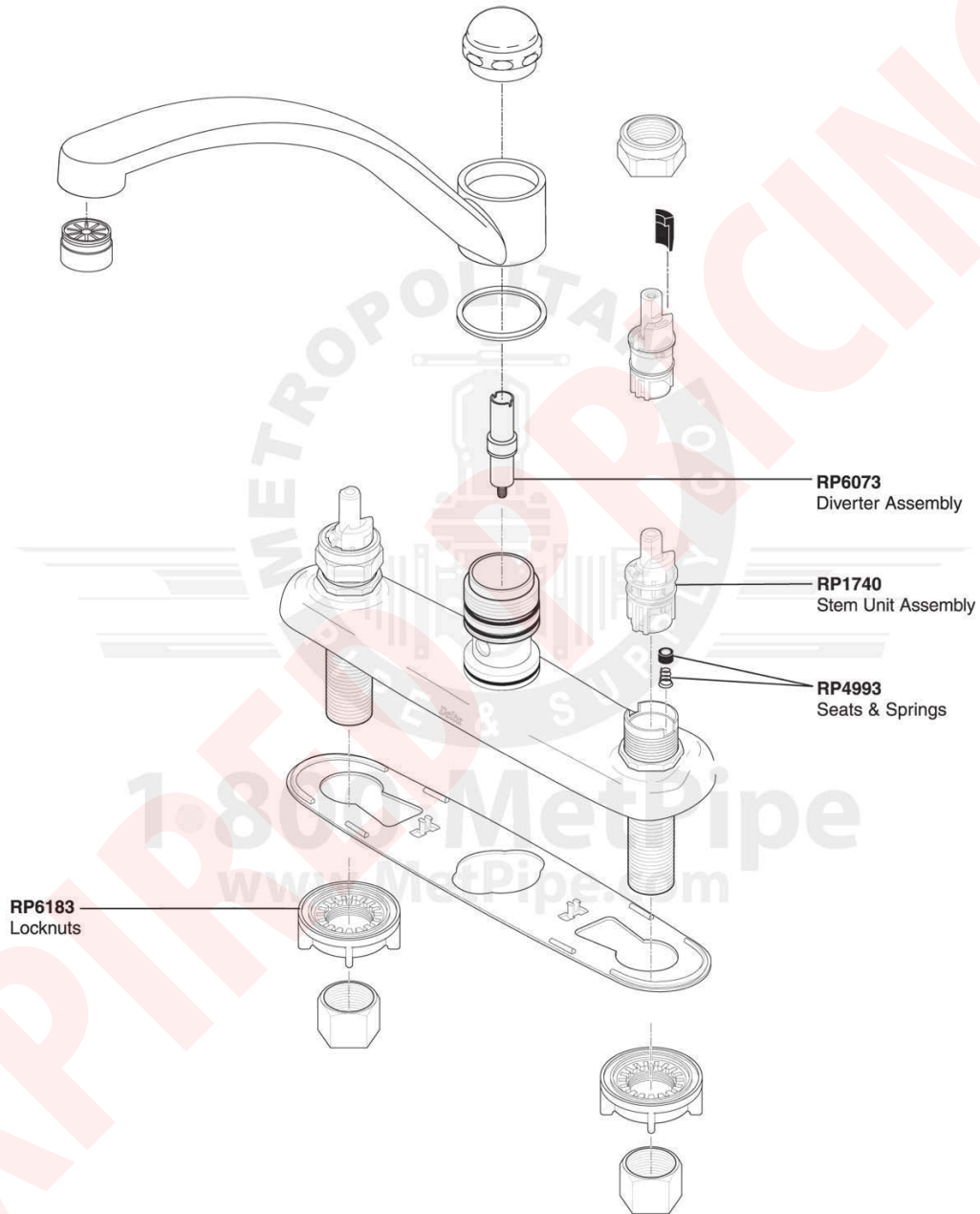

Repair Parts

Part #	Mfg #	Description	Price
39943	RP6183	Locknuts	4.38
21619	RP6073	Diverter Assembly	17.65
21556	RP1740	Stem Unit Assembly	3.85
21592	RP4993	Seats & Springs	4.24

Prices & specifications are subject to change.

We offer a variety of GREEN products such as flush valves, faucets, showerheads & more!



**Delta Models: 505, 525**

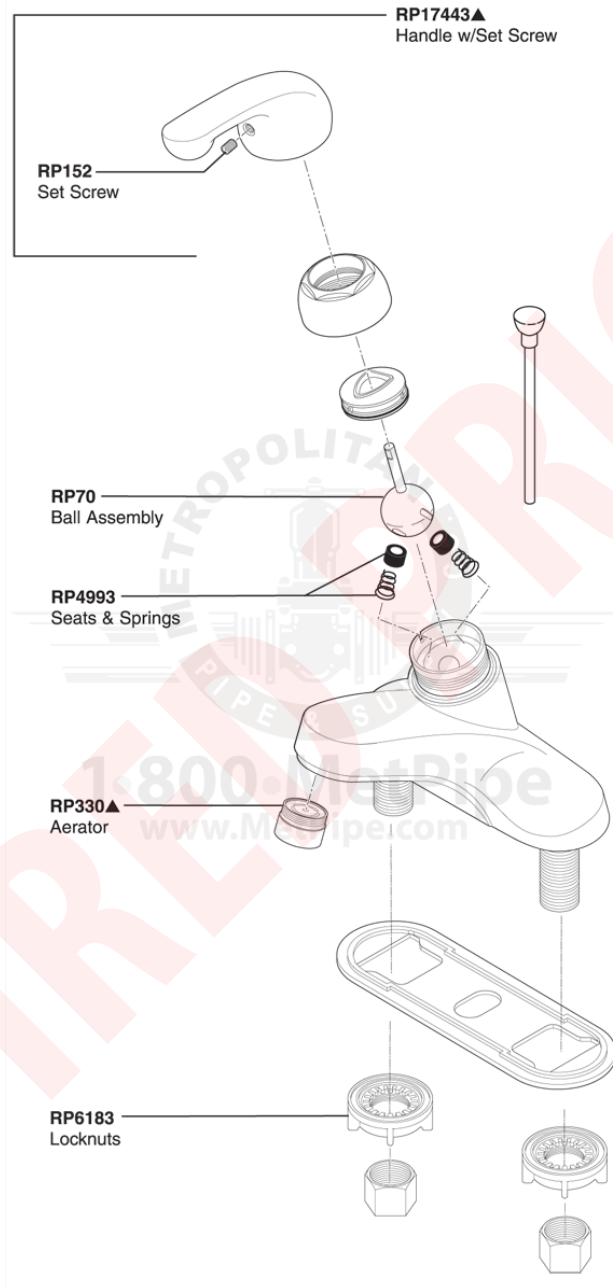

Repair Parts

Part #	Mfg #	Description	Price
46584	RP17443	Handle w/Set Screw	13.71
21554	RP152	Set Screw	3.76
21552	RP70	Ball Assembly	12.46
21592	RP4993	Seats & Springs	4.24
39943	RP6183	Locknuts	4.38
21584	RP3614	Internal Repair Kit; Includes: Ball Assembly, Seats & Springs, Gaskets	9.84

Prices & specifications are subject to change.



## Repair Parts



Delta Models: 2500, 2502, 2520, 2521, 2522

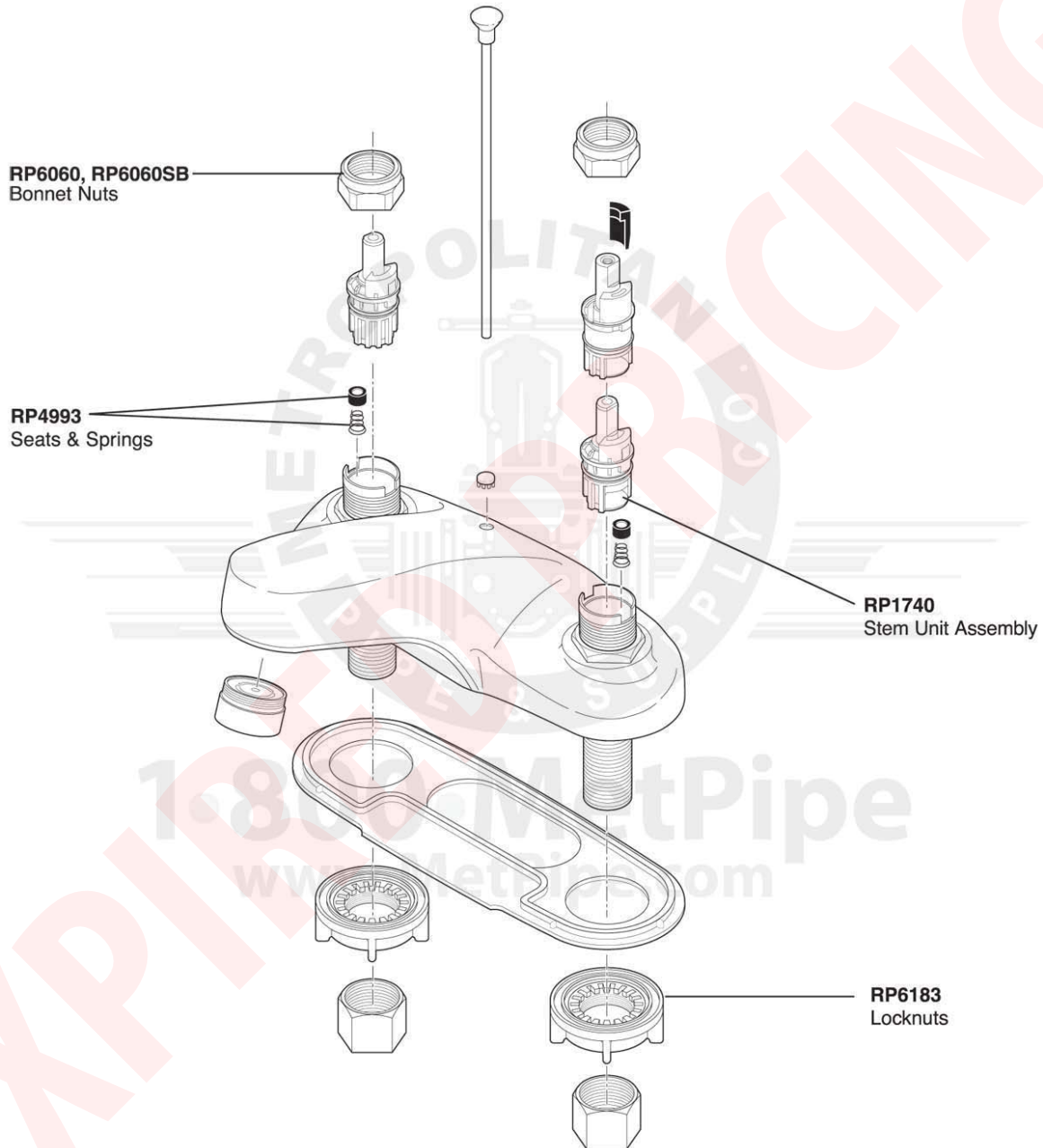

Repair Parts

Part #	Mfg #	Description	Price
21616	RP6060	Bonnet Nuts (2)	8.76
21592	RP4993	Seats & Springs	4.24
21556	RP1740	Stem Unit Assembly	3.85
39943	RP6183	Locknuts	4.38

Prices & specifications are subject to change.

Our state of the art pipe shop offers cutting, threading, grooving and make-ons up to 36in!



# Repair Parts

## Temptrol Repair Parts

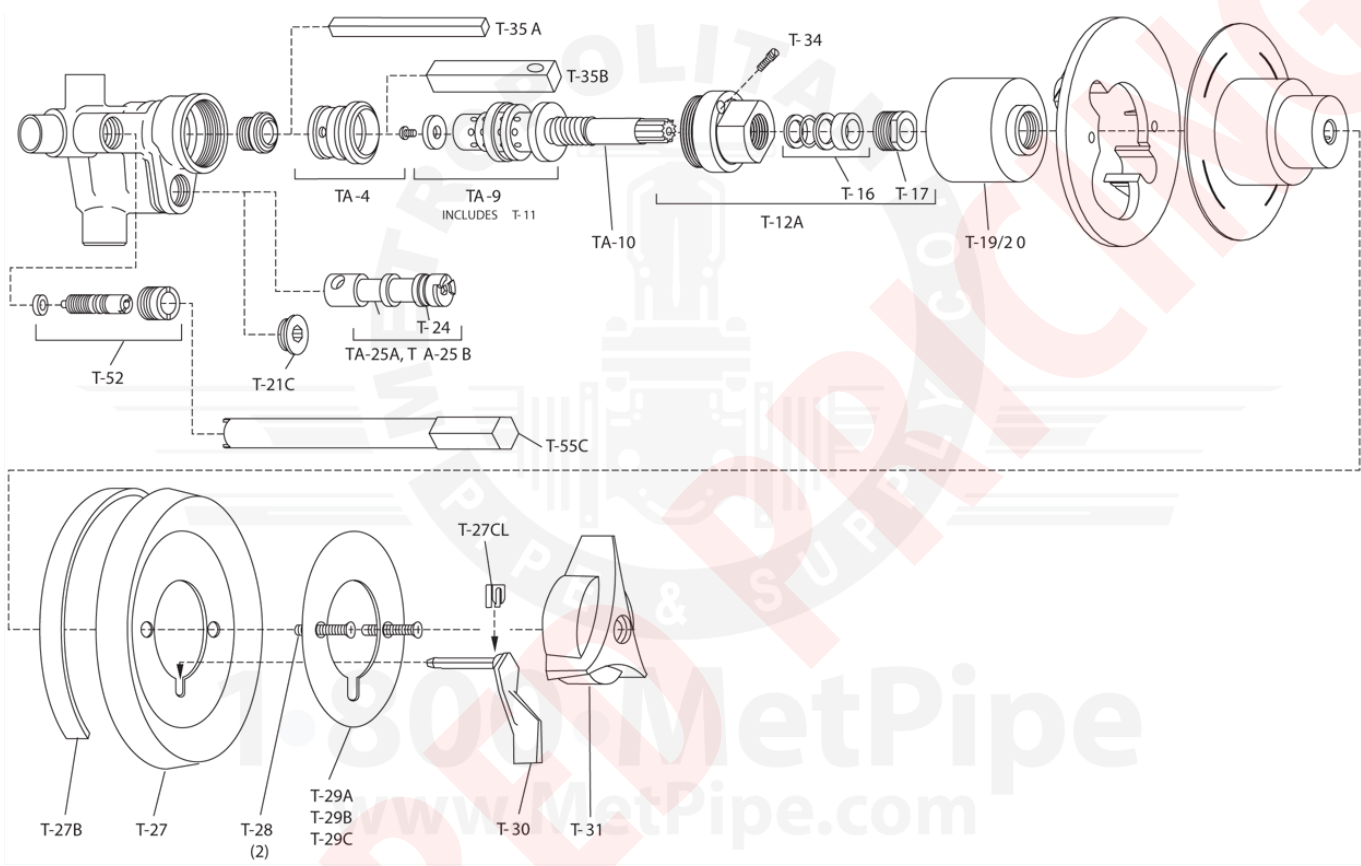

Repair Parts

Part #	Mfg #	Description	Price
27012	T-52	Stop spindle assembly/escutcheon screw retainer (T-52A), Stop plaster shield (T-55B)	26.05
27015	TA-4	Hot seat (T-1), Cold seat (T-3), Cold seat O-ring (T-2)	38.55
27016	TA-9	Hot washer screw (T-5), Hot washer (T-6), Cold washer retainer (T-7), Cold washer (T-8), Cap gasket (T-11)	5.70
27009	T-35A	Hot seat removal tool	9.65
27010	T-35B	Cold seat removal tool	9.65
27017	TA-10	Flow control spindle	63.45
27008	T-34	Limit stop with o-ring	4.35
26988	T-12A	Cap assembly	38.80
26989	T-16	Packing, O-ring and washer	3.55
26990	T-17	Packing nut	7.55
26991	T19/20	Dome cover and lock nut	14.75
44943	T-21C	Diverter retainer	2.15
26993	T-24	Spindle O-ring	2.15
182637	T-55C	Stop plaster shield removal tool	20.60
26996	T-27B	Gasket	2.00
26995	T-27	Escutcheon	30.95
26999	T-28	Escutcheon screws	2.15
27000	T-29A	Dial (Model A)	6.40
27001	T-29B	Dial (Model B)	6.40

Prices & specifications are subject to change.



## Repair Parts



### Temptrol Repair Parts (Continued)

Part #	Mfg #	Description	Price
27002	T-29C	Dial (Model C)	6.40
26997	T-27CL	Diverter handle clip	2.00
27003	T-30	Diverter / volume handle	11.45
27005	T-31	Temperature control handle: Handle screw (T-32), Plug button (T3-33R)	18.45

### Allura Repair Parts

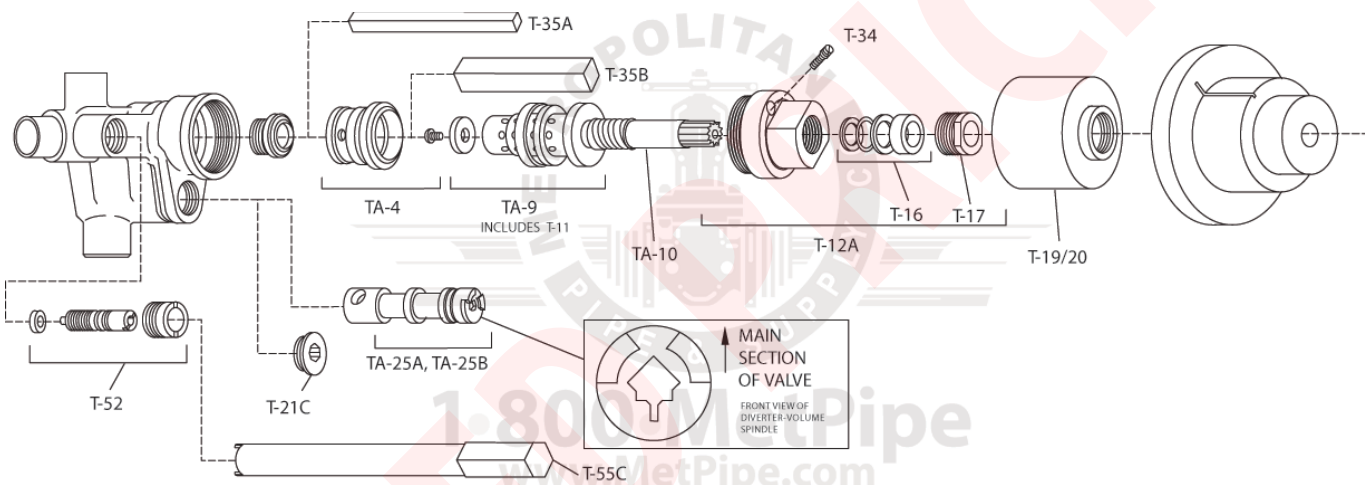

Part #	Mfg #	Description	Price
27009	T-35A	Hot seat removal tool	9.65
27010	T-35B	Cold seat removal tool	9.65
27008	T-34	Limit stop with o-ring	4.35
27015	TA-4	Hot seat (T-1), Cold seat (T-3), Cold seat O-ring (T-2)	38.55
27016	TA-9	Hot washer screw (T-5), Hot washer (T-6), Cold washer retainer (T-7), Cold washer (T-8), Cap gasket (T-11)	5.70
27017	TA-10	Flow control spindle	63.45
26989	T-16	Packing, O-ring and washer	3.55
26990	T-17	Packing nut	7.55
26991	T19/20	Dome cover and lock nut	14.75
26988	T-12A	Cap assembly	38.80
27012	T-52	Stop spindle assembly/escutcheon screw retainer (T-52A), Stop plaster shield (T-55B)	26.05
44943	T-21C	Diverter retainer	2.15
27019	TA-25A	Diverter/volume spindle (T-23A), O-ring (T-24) for Model A tub/shower valve (beige or gray)	8.35
27020	TA-25B	Volume spindle (T-23B), O-ring (T-24) for Model B shower valve (black)	8.35
182637	T-55C	Stop plaster shield removal tool	20.60



## Repair Parts

### SafetyMix Repair Parts

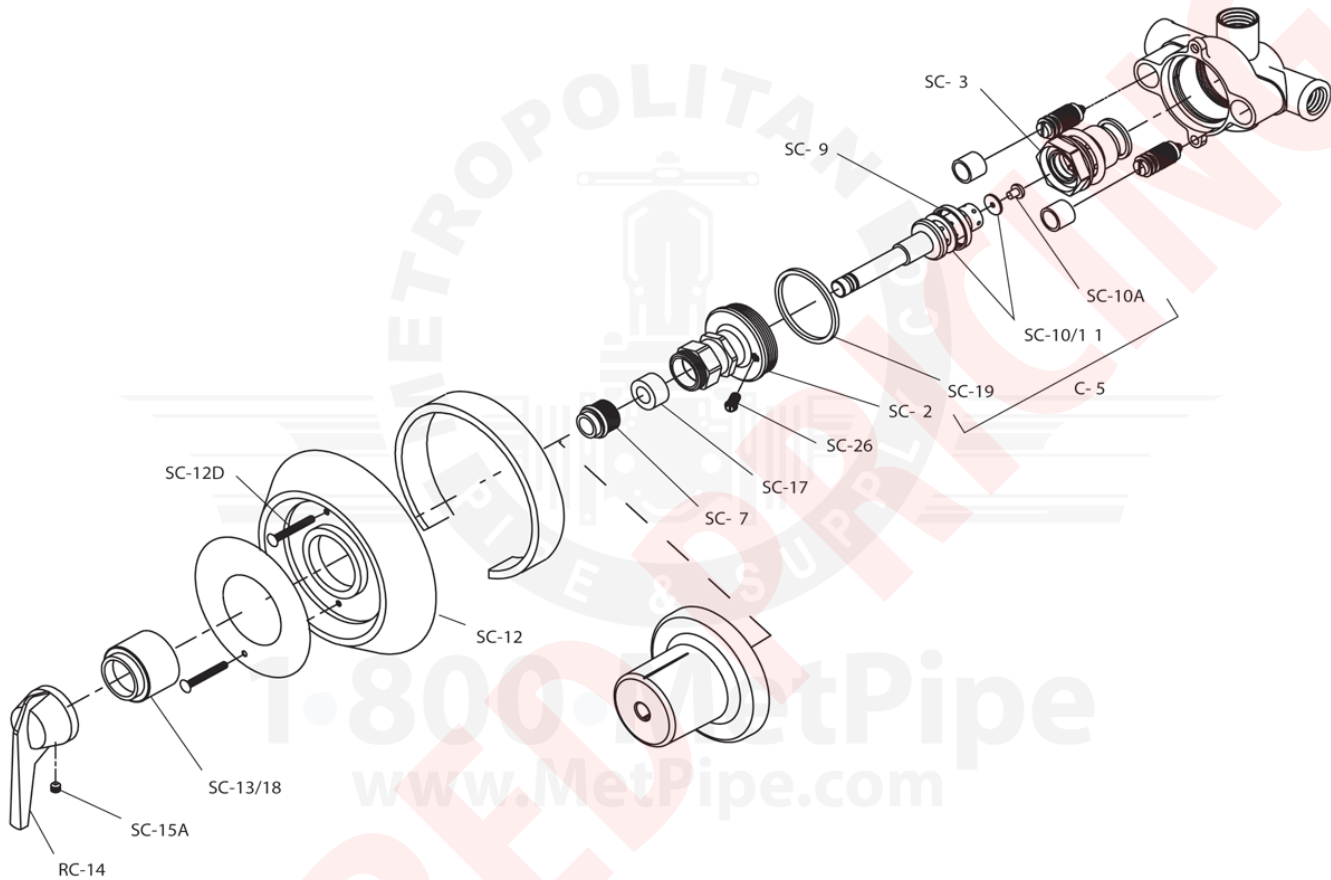

Repair Parts

Part #	Mfg #	Description	Price
26966	RC-14	Lever handle	52.65
239827	SC-15A	Handle screw	2.00
26977	SC-13/18	Dome cover and lock nut	20.40
26976	SC-12	Escutcheon and screw	73.85
26975	SC-7	Packing nut with o-rings	7.40
26983	SC-26	Limit stop with o-ring	4.35
26973	SC-2	Cap	58.20
26904	C-5	Spindle	92.55
26974	SC-3	Renewable Seat Unit (Complete)	49.30
26941	KIT-B	Washer & Gasket Kit: SC-9 (Cold washer retainer), SC-10A (Hot washer screw), SC-10/11 (Hot and cold washers), SC-15 (Handle screw), SC-17 (Packing), SC-19 (Cap gasket)	15.05

Prices & specifications are subject to change.





## Repair Parts



### Visu-Temp Repair Parts

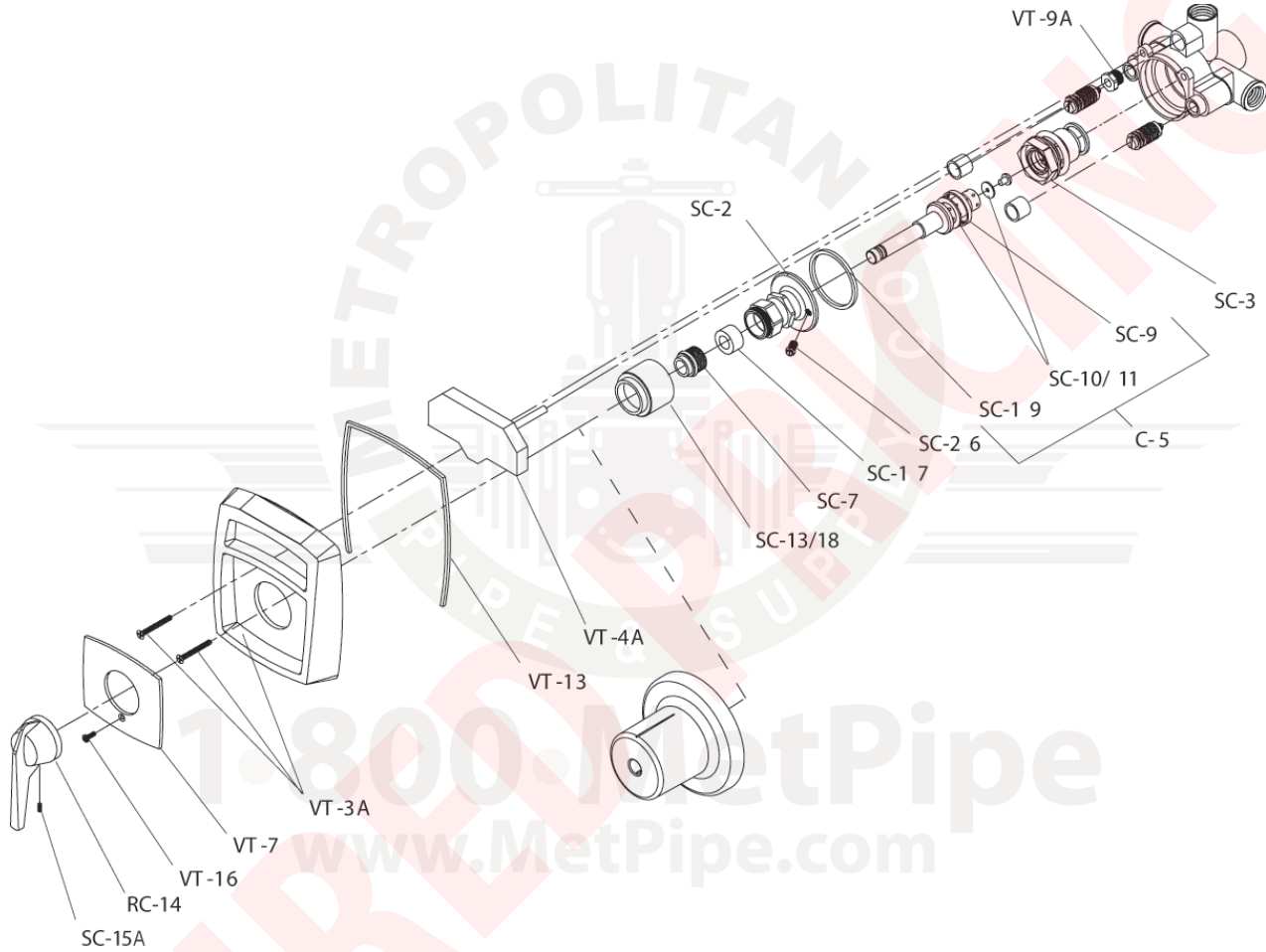

Repair Parts

Part #	Mfg #	Description	Price
26966	RC-14	Lever handle	52.65
239827	SC-15A	Handle screw	2.00
26977	SC-13/18	Dome cover and lock nut	20.40
26975	SC-7	Packing nut with o-rings	7.40
26983	SC-26	Limit stop with o-ring	4.35
26973	SC-2	Cap	58.20
26904	C-5	Spindle	92.55
26974	SC-3	Renewable Seat Unit (Complete)	49.30
27033	VT-16	Dial Screw	1.10
27030	VT-7	Dial	15.95
27028	VT-3A	Escutcheon screws (2)	55.60
27032	VT-13	Escutcheon gasket	2.85
27029	VT-4A	Thermometer assembly	127.30
27031	VT-9A	Retainer assembly	7.65
26942	KIT-B-VT	Washer & Gasket Kit: SC-9 (Cold washer retainer), SC-10A (Hot washer screw), SC-10/11 (Hot and cold washers), SC-15A (Handle screw), SC-17 (Packing), SC-19 (Cap gasket), VT-9A (Retainer assembly), VT-13 (Escutcheon gasket)	20.95

Prices & specifications are subject to change.

Metropolitan Pipe offers Vendor Managed Inventory - never run out of that part again!



## Repair Parts

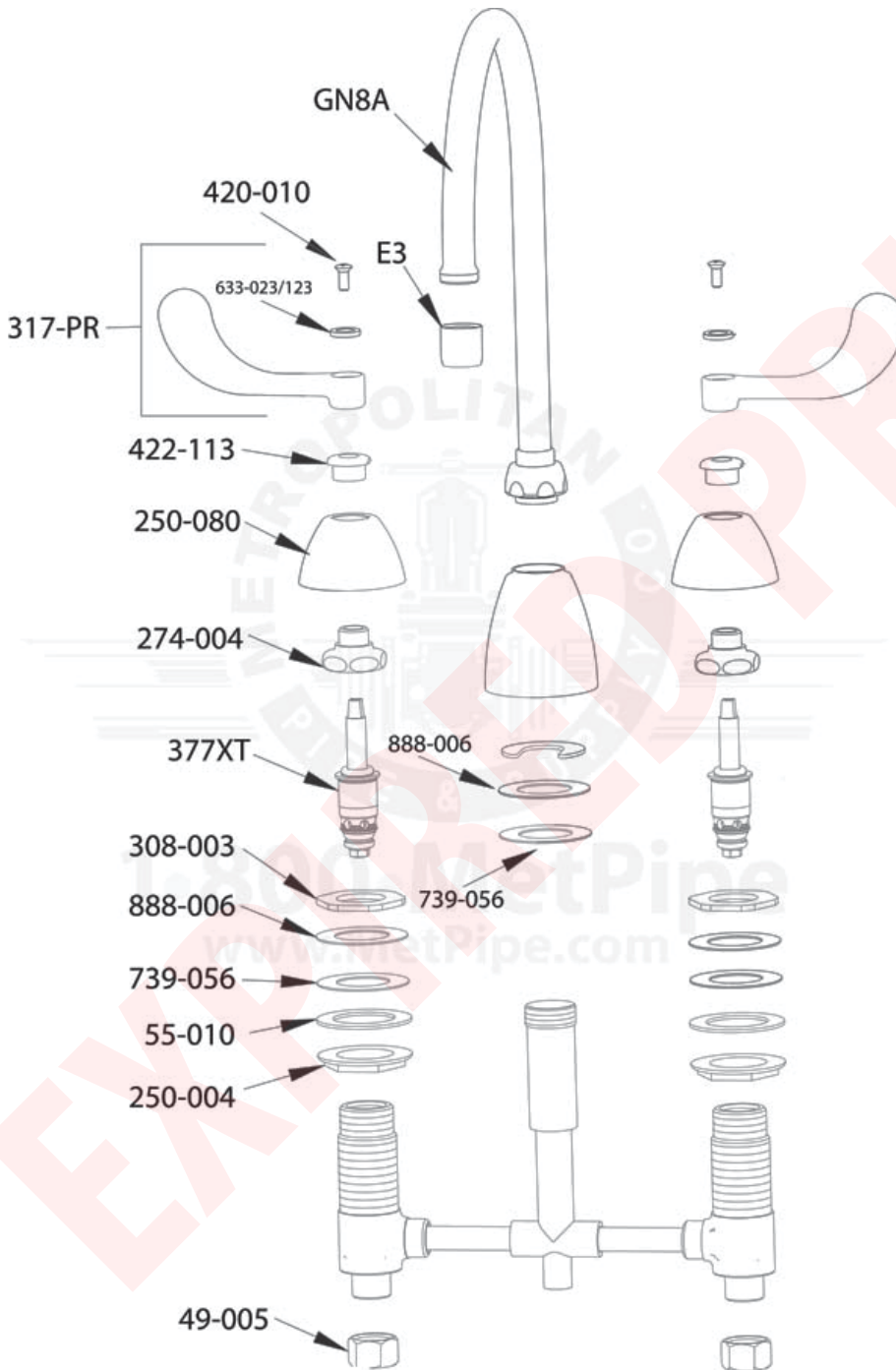

### Chicago 201-AGN8AE3317CP

Part #	Mfg #	Description
21099	E3	Softflo Outlet
21125	GN8A	Spout
217964	890-259	Spout Escutcheon
21195	420-010	Screw
113559	633-023	Index Button (Red)
113560	633-123	Index Button (Blue)
21182	317-PR	Wrist blade Handle Assy.
121390	422-113	Escutcheon Nut
121117	250-080	Escutcheon
45329	274-004	Cap Nut
21189	377XTLH	Lh Quatern Cartridge
21190	377XTRH	Rh Quatern Cartridge
140449	308-003	Locknut
144024	888-006	Brass Washer
139300	739-056	Rubber Washer
147177	55-010	Steel Washer
117580	250-004	Locknut
120108	49-005	Coupling Nut

Repair Parts

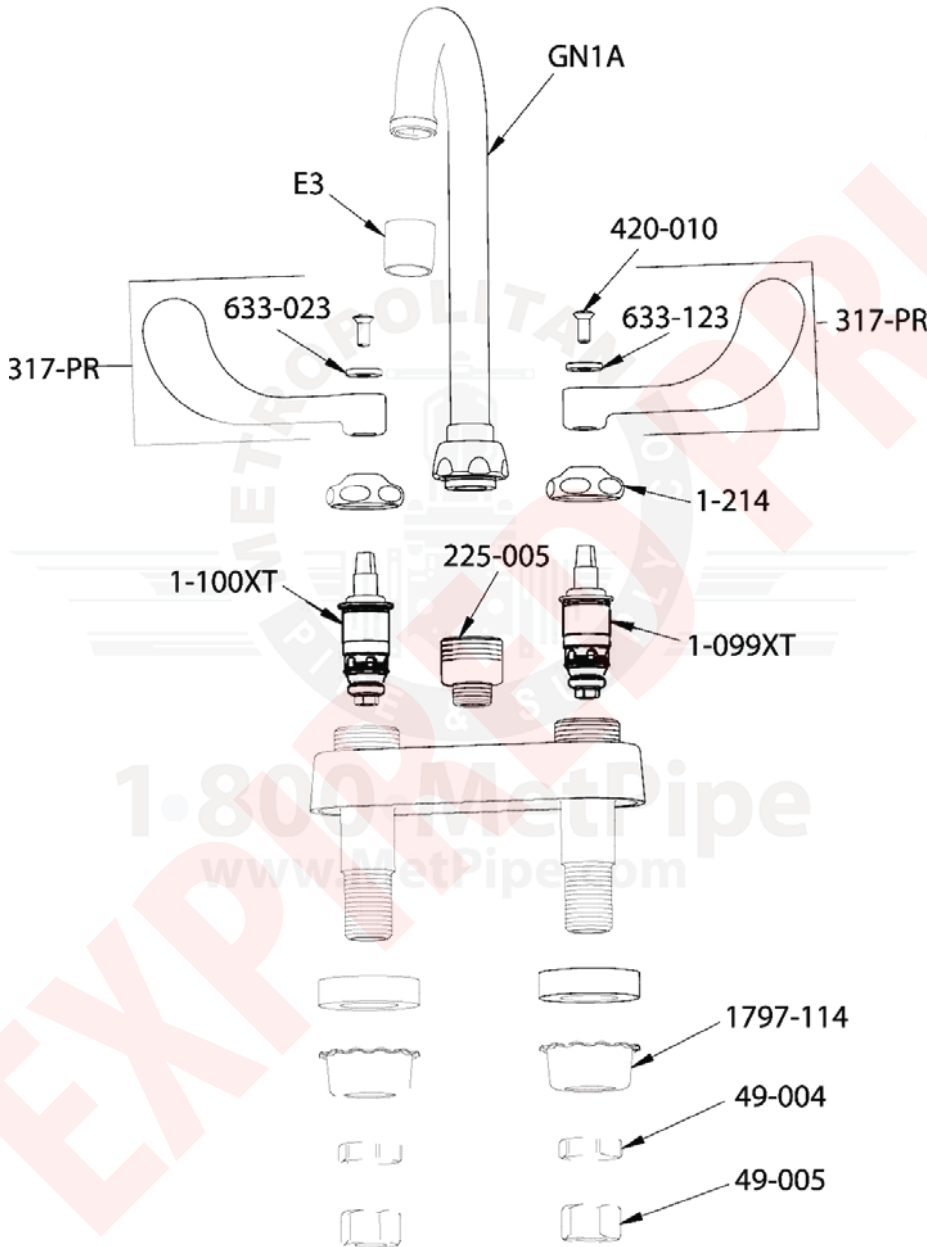

**Chicago**  
**895-317**

Part #	Mfg #	Description
21195	420-010	Screw
113560	633-123	Index Button (Blue)
113559	633-023	Index Button (Red)
21182	317-PR	Wrist blade Handle Assy.
21137	1-214	Cap
21150	1-099XT	Quatum Unit (Rh)
21153	1-100XT	Quatum Unit (Lh)
875004	555-313	Washer
158000	1797-114	Basin Cock Washer
120766	49-004	Locknut
120108	49-005	Coupling Nut
112087	225-005	Adapter
21119	GN1A	Spout
21099	E3	Softflo Outlet



## Repair Parts

### Chicago 930

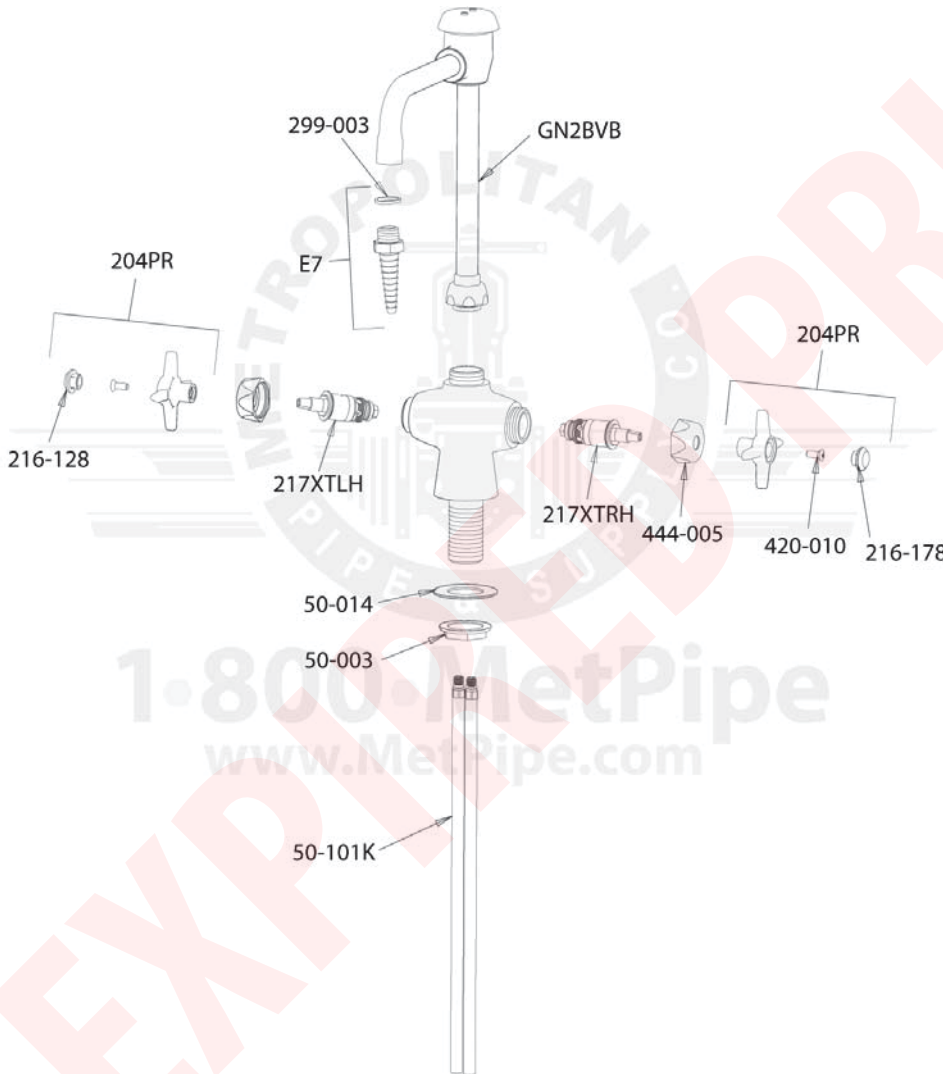

Part #	Mfg #	Description
21124	GN2BVB	V B Spout B Type End
56559	229-003	Washer
21107	E7	Lab Nozzle Outlet
49274	204PR	4-Arm Handle Assembly
21164	216-178	'Cw' Index Button
21165	216-128	'Hw' Index Button
21195	420-010	Screw
53733	444-005	Cap Nut
121040	217XTRH	Slo-Compression Unit (Rh)
121039	217XTRH	Slo-Compression Unit (Lh)
120772	50-014	Steel Washer
43674	50-003	Locknut
55356	50-101K	Supply Tube Assembly

Repair Parts

1-800-MetPipe  
 www.MetPipe.com

Prices & specifications are subject to change.



## Repair Parts

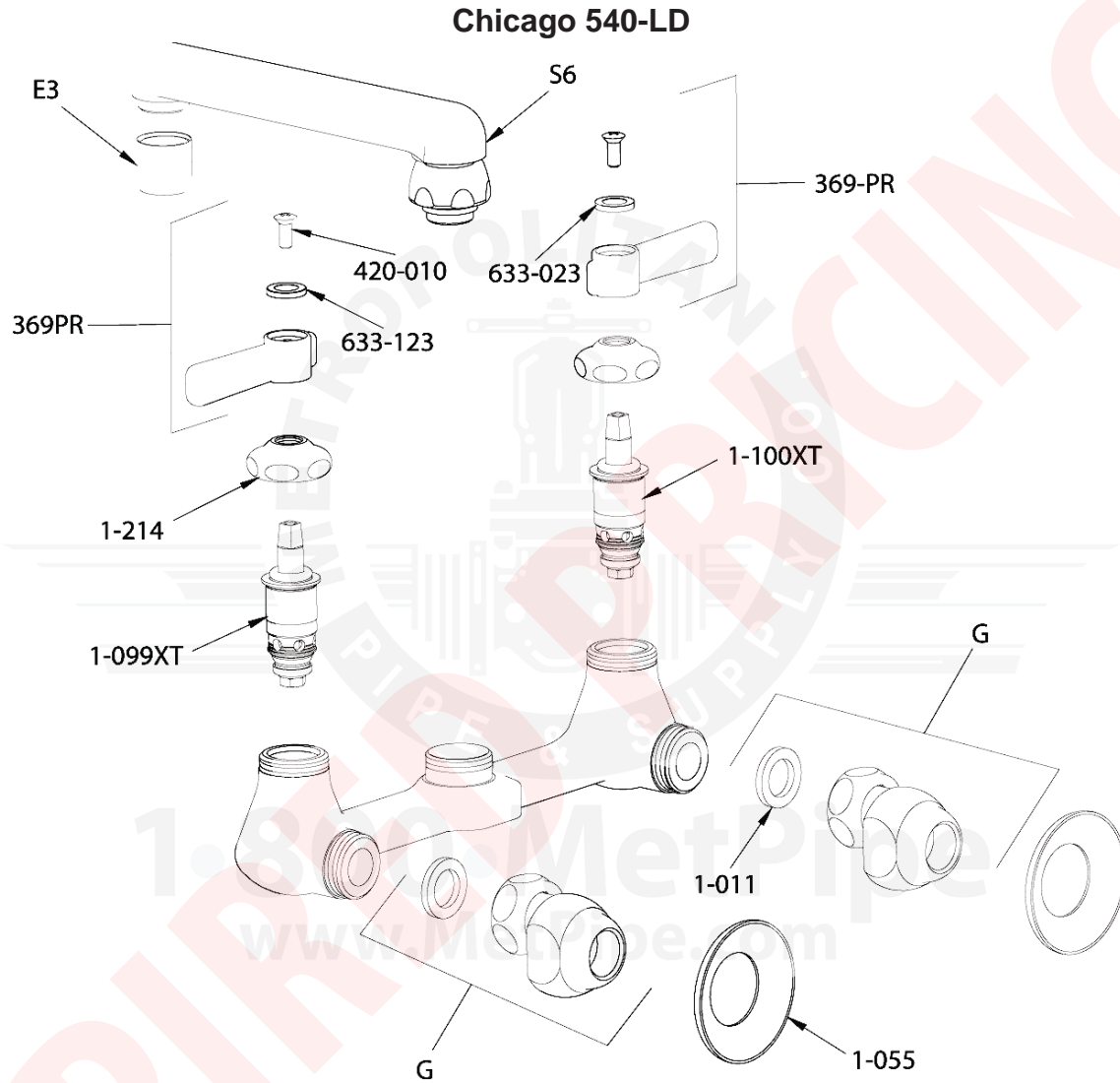

Repair Parts

Part #	Mfg #	Description	Price
21124	GN2BVBJK-CP	V B Spout B Type End	115.32
56559	229-003JKNF	Washer	0.94
21107	E7JK-CP	Lab Nozzle Outlet	15.13
49274	204-PRJKCP	4-Arm Handle Assembly	48.89
21164	216-178JKNF	'Cw' Index Button	3.42
21165	216-128JKNF	'Hw' Index Button	3.42
21195	420-010JKRCF	Screw	1.02
53733	444-005JKCP	Cap Nut	12.31
121040	217-XTRHJKNF	Slo-Compression Unit (Rh)	16.20
121039	217-XTLHJKNF	Slo-Compression Unit (Lh)	16.20
120772	50-014JKNF	Steel Washer	1.29
43674	50-003JKRBF	Locknut	4.55
55356	50-101K	Supply Tube Assembly	8.98

Prices & specifications are subject to change.

Our office hours are 7am to 4:30pm and counter hours 6am to 4:30pm Monday through Friday.



## Repair Parts

### Chicago 625-CP

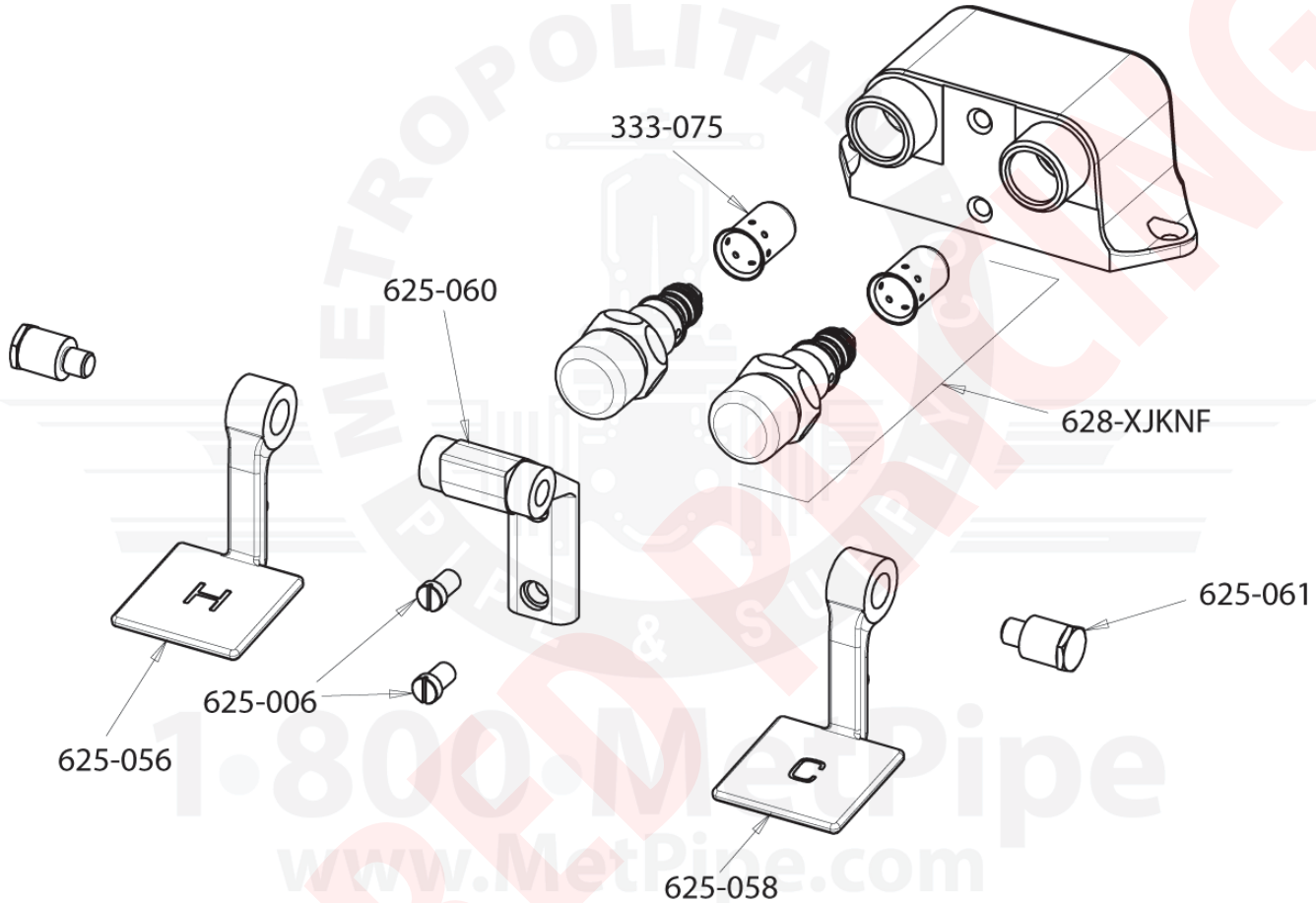

Repair Parts

Part #	Mfg #	Description	Price
147073	333-075JKNF	Dashpot	12.61
57000	628-XJKNF	Cartridge Assembly	62.64
197948	625-060JKCP	Bracket	55.77
121564	625-006JKBNF	Screw, pan head 5/16-18 UNC	5.71
121569	625-058JKNF	Pedal, Hot	41.83
121575	625-158JKNF	Pedal, Cold	41.83
121573	625-061JKRCF	Bolt, Shoulder 3/8-24 UNF x 5/8 Hex	7.97

Prices & specifications are subject to change.



# Repair Parts



## Hot & Cold Spindle Assemblies

### Eterna Cartridge

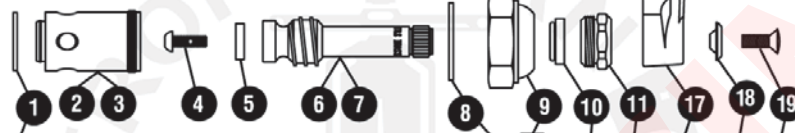

**For Standard Faucets**  
 Ref. Part No.  
 Hot Side 002714-40  
 Cold Side 002713-40

### Eterna Cartridge with Spring Check

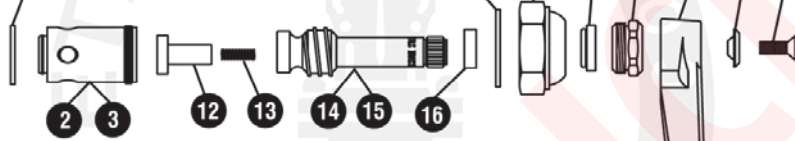

**For Pre-Rinse Units**  
 Ref. Part No.  
 Hot Side 002712-40  
 Cold Side 002711-40

### Big-Flo Assembly

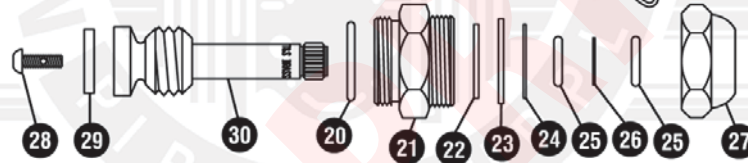

Ref. Part No.  
 Hot and Cold Side  
 006482-40

### B-1100 Series



Ref. Part No.  
 Hot Side 002710-40  
 Cold Side 002709-40

### Ceramic Cartridges

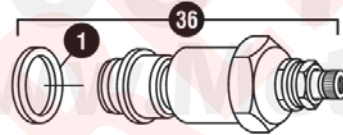

For use with  
 Escutcheon  
 (Ceramic - ESC)

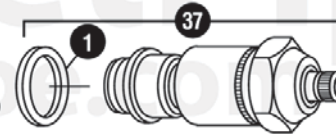

For use without  
 Escutcheon  
 (Ceramic - NO ESC)

Cerama Cartridge with Escutcheon

Cerama Cartridge without Escutcheon

Part #	Mfg #	Description	Price
27230	001022-45	1- Bottom Gasket	26.05
27231	000788-20	2- Removable Insert (Hot) 64-L	38.55
27235	000789-20	3- Removable Insert (Cold) 66L	5.70
27163	000933-45	4- Seat Screw	9.65
27158	001092-45	5- Seat Washer	9.65
27153	000811-25	6- Spindle (Hot) 18L	63.45
27237	000812-25	7- Spindle (Cold) 67L	4.35
27232	002601-45	8- Top Gasket	38.80
955099	009744-45	9- Bonnet	3.55
955100	013430-45	10- Bonnet Seal Packing	7.55
27208	000718-25	11- Packing Nut	14.75
36672	003164-45	12- Spring Check Seat	2.15
36673	001479-45	13- Spring	2.15
955103	001907-25	14- Spindle (Hot) 264L	20.60
936798	001908-25	15- Spindle (Cold) 263L	2.00
955104	001466-20	16- Quarter Turn Sleeve	30.95
871837	001638-45	17- Lever Handle, Blank	2.15

Prices & specifications are subject to change.

You can check stock availability, pricing and place orders online at [www.MetPipe.com](http://www.MetPipe.com).



## Repair Parts

### Hot & Cold Spindle Assemblies (Continued)

Part #	Mfg #	Description	Price
861569	001637-45	17- Lever Handle, Hot	6.40
861569	001636-45	17- Lever Handle, Cold	6.40
27270	001661-45	18- Index, Red, Hot	6.40
27269	001660-45	18- Index, Blue, Cold	2.00
27135	000922-45	19- Lever Handle Screw	11.45
955105	002721-45	20- O-Ring	18.45
Call	000685-20	21- Removable Insert	Call
27103	000976-45	22- Brass Washer	Call
27240	001042-45	23- Rubber Washer	Call
27111	002726-45	24- Stainless Steel Washer	Call
27209	001075-45	25- O-Ring	Call
955106	009752-45	26- Washer	Call
955107	009750-25	27- Bonnet	Call
27163	000933-45	28- Seat Screw	Call
27257	001088-45	29- Seat Washer	Call
27258	000794-25	30- Spindle (Hot and Cold)	Call
27105	001047-45	31- Rubber Washer	Call
955108	009749-25	32- Bonnet	Call
27100	000986-45	33- Brass Washer	Call
27143	000801-25	34- Spindle (Cold)	Call
27096	000800-25	35- Spindle (Hot)	Call
951368	011616-25	36- Hot	Call
951372	011617-25	36- Cold	Call
955109	011618-25	36- Hot with Check Valve	Call
886478	011619-25	36- Cold with Check Valve	Call
955110	011278-25	37- Hot	Call
955111	011279-25	37- Cold	Call
955112	012394-25	37- Hot with Check Valve	Call
886479	012395-25	37- Cold with Check Valve	Call

Repair Parts





**Repair Parts**



**Pre-Rinse Parts Explosion**

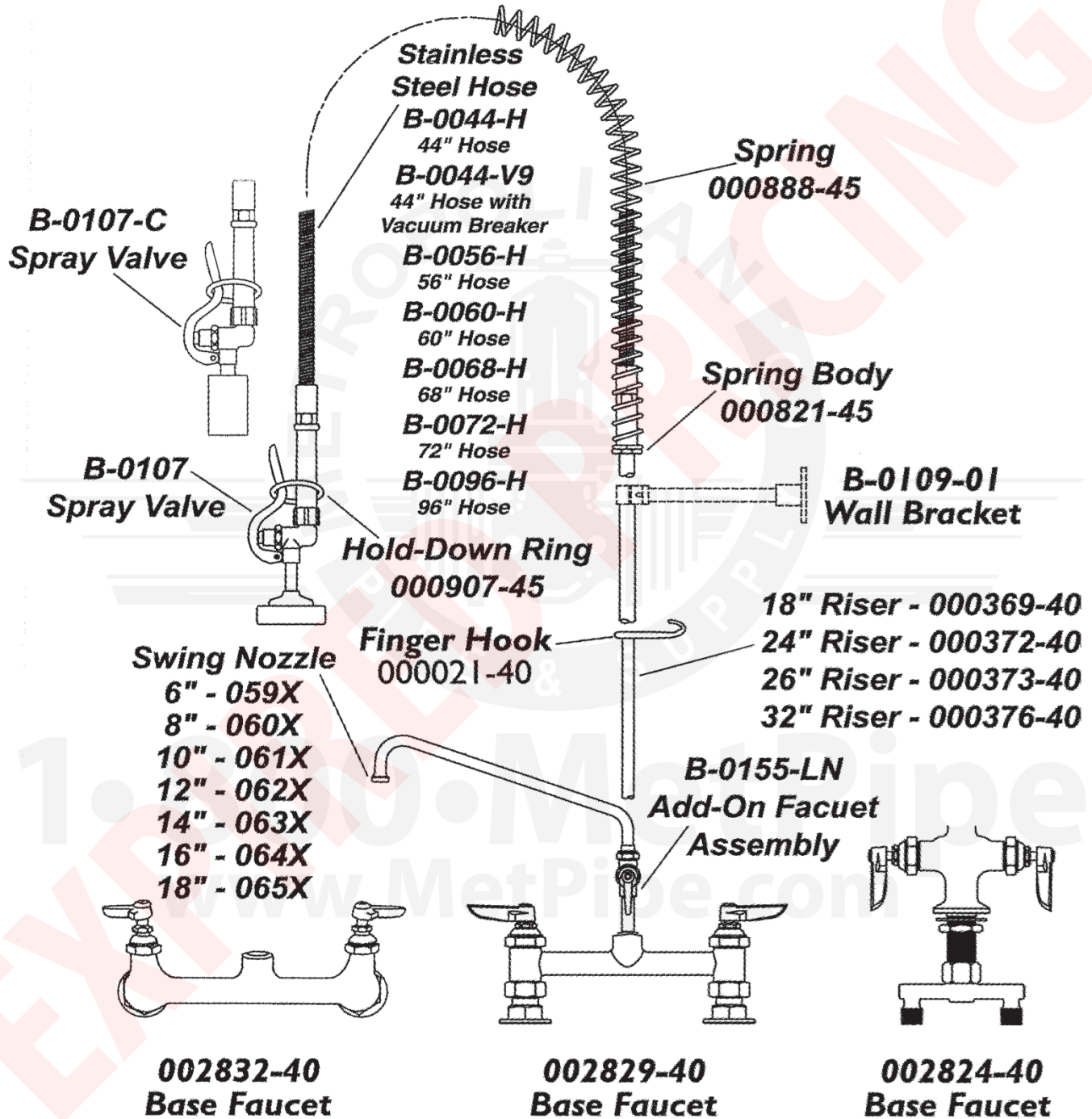

Repair Parts

Part #	Mfg #	Description	Price
940988	B-0107-C	Spray Valve	Call
14533	B-0107	Spray Valve	Call
14490	059X	Swing Nozzle	Call
14491	060X	Swing Nozzle	Call
14492	061X	Swing Nozzle	Call

Prices & specifications are subject to change.

We offer a variety of GREEN products such as flush valves, faucets, showerheads & more!



## Repair Parts

### Pre-Rinse Parts Explosion (Continued)

Part #	Mfg #	Description	Price
857441	062X	Swing Nozzle	Call
925782	063X	Swing Nozzle	Call
239208	064X	Swing Nozzle	Call
14496	065X	Swing Nozzle	Call
27217	002832-40	Base Faucet	Call
14517	B-0044-H	Stainless Steel Hose - 44in	Call
218796	B-0044-V9	Stainless Steel Hose - 44in w/ Vacuum Breaker	Call
955118	B-0056-H	Stainless Steel Hose - 56in	Call
118141	B-0060-H	Stainless Steel Hose - 60in	Call
14521	B-0068-H	Stainless Steel Hose - 68in	Call
798879	B-0072-H	Stainless Steel Hose - 72in	Call
224610	B-0096-H	Stainless Steel Hose - 96in	Call
27064	000907-45	Hold-down Ring	Call
27085	000021-40	Finger Hook	Call
27216	002829-40	Base Faucet	Call
27053	000888-45	Spring	Call
Call	000821-45	Spring Body	Call
14536	B-0109-01	Wall Bracket	Call
27090	000369-40	Riser - 18in	Call
941118	000372-40	Riser - 24in	Call
955119	000373-40	Riser - 26in	Call
955120	000376-40	Riser - 32in	Call
908405	B-0155-LN	Add-on Faucet Assembly	Call
27214	002824-40	Base Faucet	Call

Repair Parts

**1•800•MetPipe**  
**www.MetPipe.com**

Prices & specifications are subject to change.



## Repair Parts



B-0107 Spray Valve

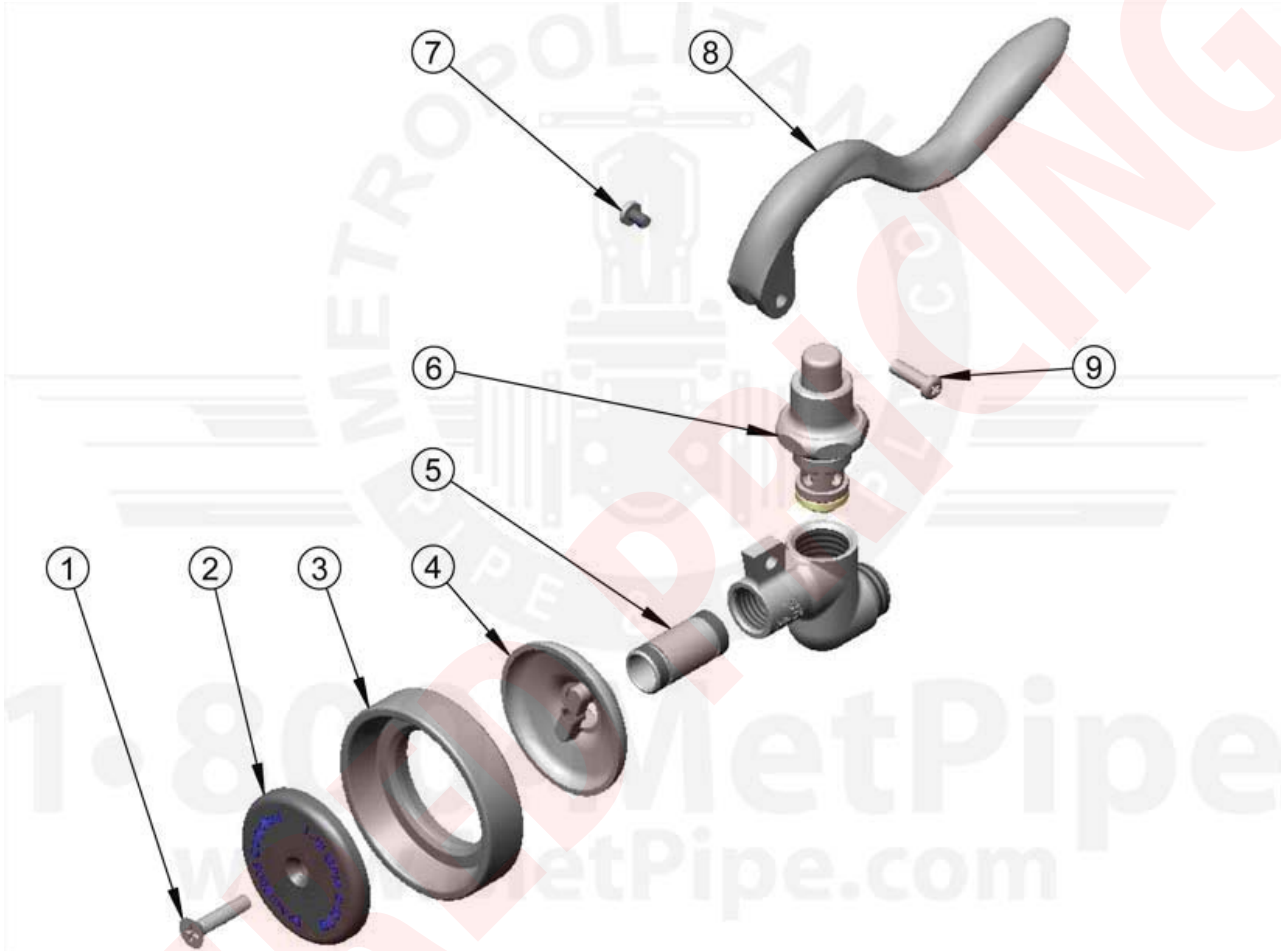

Part #	Mfg #	Description	Price
27046	000913-45	1 - Screw	Call
27045	001121-45	2 - Spray Face	Call
27047	007861-45	3 - Sprayhead Ring	Call
111168	000019-40	4 - Spray Cup	Call
27048	000694-40	5 - Short Nipple Plated	Call
864957	002856-40	6 - Bonnet Asm, Spray Valve	Call
134059	003199-45	7 - Handle Screw, Spray Valve	Call
27061	001120-45	8 - Spray Valve Handle	Call
134066	003198-45	9 - Handle Nut, Spray Valve	Call

Repair Parts

Prices & specifications are subject to change.

Our state of the art pipe shop offers cutting, threading, grooving and make-ons up to 36in!



## Specifications & Reference Information

### Abbreviation Definitions

Abbreviation	Definition
<b>AAR</b>	Association of American Railroads
<b>AGA</b>	American Gas Association
<b>AISI</b>	American Iron & Steel Institute
<b>ANSI</b>	American National Standards Institute (Formerly ASA)
<b>API</b>	American Petroleum Institute
<b>ASA</b>	American Standard Institute — Now known as ANSI
<b>ASM</b>	American Society for Metals
<b>ASME</b>	American Society of Mechanical Engineers
<b>ASTM</b>	American Society for Testing Materials
<b>AWWA</b>	American Water Works Association
<b>Bales</b>	Banded lifts of pipe
<b>Bar Mill</b>	Rolling mill where blooms are processed to form billets
<b>Bevel</b>	The angle formed between the prepared edge of the end of the pipe and a plane perpendicular to the surface. Standard line pipe bevel is 30 degrees.
<b>Billet</b>	Round solid bar of steel which is pierced to form a seamless tube or pipe.
<b>BLK</b>	Black - term used when O.D. surface of pipe is protected with a varnish-type oil. Also applies to bare pipe to denote not galvanized.
<b>Bloom</b>	Semi-finished hot rolled product produced on a blooming mill.
<b>BOF</b>	Basic Oxygen Furnace
<b>BTU</b>	British Thermal Unit
<b>Burst Test</b>	A destructive hydraulic test to determine actual yield strength and ultimate strength of seamless and welded pipe.
<b>BW</b>	Butt Weld Pipe - See Continuous Weld Pipe
<b>Casing</b>	Pipe used as a structural retainer for the walls of a water, gas, or oil well.
<b>CD</b>	Cold Drawn - Drawing pipe or tubing through a die to reduce diameter and wall, to obtain closer tolerances, a better finish or higher physical properties.
<b>Chamfer</b>	A beveled surface to eliminate an otherwise sharp corner. A finishing operation prior to threading.
<b>Chemical Properties</b>	Normally associated with a limited number of chemical elements. Minimum or maximum limits are established in most ASTM and API Specifications.
<b>Cut Length</b>	Pipe out to a specific length as ordered.
<b>Conduit</b>	Pipe serving as a duct for electrical wiring. Usually supplied in 10 foot lengths, threaded and coupled. Pipe used is normally galvanized, slightly lighter than standard weight with a smooth interior surface.
<b>CPLG</b>	Coupling - threaded sleeve used to connect two lengths of pipe.
<b>CW</b>	Continuous Weld - method of producing pipe normally in sizes from ½ inch to 4 inch.
<b>Cu</b>	Copper
<b>CWT</b>	Per hundred weight
<b>DIA</b>	Diameter
<b>Die Stamping</b>	Permanent marking placed on pipe as required in some specifications.
<b>Extra Extra Heavy (XXH)</b>	Also known as double extra strong. Available from ½ inch to 8 inch nominal pipe. Wall thickness is twice as heavy as extra heavy pipe with the exception of 8 inch diameter.
<b>DRL</b>	Double Random Length (35 foot minimum average)
<b>Drifted</b>	Attaining a certain minimum I.D. clearance by pushing a mandrel through pipe or tubing.
<b>Drive Pipe</b>	Pipe used for driving into ground in water well applications. Supplied with drive coupling.
<b>Ductility</b>	The ability of a material to deform plastically without fracturing. Measured by elongation in a tensile test.



## Specifications & Reference Information

<b>ERW</b>	Electric Resistance Weld Pipe - method of producing pipe normally in sizes from 2 3/8" O.D. through 22" O.D.
<b>EUE</b>	External Upset Ends - used in API tubing and drill pipe.
<b>Expanded Pipe</b>	Pipe which has been enlarged circumferentially by mechanical or hydraulic pressure.
<b>Extra Heavy</b>	Also known as extra strong - pipe with walls heavier than standard weight. Same as schedule 80 in sizes 1/8 inch to 8 Inch diameter.
<b>FOB</b>	Free on Board Freight
<b>Galv</b>	Galvanizing - coating pipe with a protective coating of zinc.
<b>Grade A or B</b>	Designations used to indicate minimum yield and tensile strengths of steel in seamless and welded pipe.
<b>GT</b>	Gross Ton - 2,240 pounds
<b>Hydrostatic Testing</b>	High pressure, water test to predetermine pressures as required by specifications.
<b>ID</b>	Inside Diameter - The O.D. measurement less double the wall thickness is the I.D. measurement of a pipe or tube.
<b>Ingot</b>	Usually first solid form of steel, Suitable for reworking or remelting.
<b>IPS</b>	Iron Pipe Size - Same as nominal size from 1/8 inch to 12 Inch.
<b>Joint</b>	Term used to refer to one length of pipe.
<b>LGTH</b>	Length
<b>LTC</b>	Long threads and coupling (OCTG)
<b>LW</b>	Lap Weld - Old method of producing pipe 5 inch diameter and over.
<b>Mechanical Properties</b>	Tensile strength, elongation, hardness and fatigue limit of steel.
<b>Mid-welds</b>	Two or more Joints welded to form one long joint.
<b>Minimum Wall</b>	Minimum thickness permissible calculated by subtracting minus tolerance from nominal wall.
<b>Mn</b>	Manganese
<b>NASPD</b>	The National Association of Steel Pipe Distributors
<b>NBS</b>	National Bureau of Standards
<b>Ni</b>	Nickel
<b>Nipple</b>	Short length of pipe 12 inches and under normally threaded both ends.
<b>NOM</b>	Nominal - name given to standard pipe designations 1/8 inch through 12 inch. Does not indicate actual I.D. measurements, Wall thicknesses are also expressed as nominal.
<b>NT</b>	Net Ton - 2,000 pounds
<b>OD</b>	Outside diameter
<b>OH</b>	Open hearth
<b>PCS</b>	Pieces
<b>PE</b>	Plain ends
<b>PERC</b>	Plain end roller cut
<b>PESC</b>	Plain end square cut or saw cut or machine cut
<b>Pickling</b>	Pipe immersed in acid bath to remove scale, oil, dirt, etc.
<b>Protector</b>	Sleeve with threads to protect threads
<b>PSI</b>	Pounds per square inch.
<b>Range</b>	Allowable lengths in oil field casing and tubing. Expressed as Range 1 (20 foot R/L). Range 2 (30 foot R/L) and Range 3 (40 foot R/L).
<b>RL</b>	Random Length. Varying lengths of pipe.
<b>R&amp;D</b>	Reamed and Drifted - commonly used in water wells to guarantee I.D. clearance
<b>SAW</b>	Submerged Arc Weld - a method of producing very large OD pipe.
<b>Scale</b>	An oxide of Iron which forms on the surface of steel.
<b>Schedule Numbers</b>	ANSI numbers assigned to pipe to designate wall thickness.
<b>SMLS</b>	Seamless - pipe without a seam or weld in the circumference.
<b>Spec</b>	Specification



## Specifications & Reference Information

<b>SRL</b>	Single Random Lengths - usually 18 foot to 22 foot. Minimum average of 17'6".
<b>ST&amp;C</b>	Short Thread & Coupled (OCTG).
<b>Stencil</b>	Identification painted on pipe. Specification, size, wall, grade, test pressure, etc.
<b>STD</b>	Standard - Same as Sch. 40 1/8"-1.0"
<b>Stretch Reduce</b>	A technique employed in the manufacture of OW pipe in which one or several master sizes of pipe are produced, then stretched reduced through a number of rolls to achieve a variety of pipe diameters. Also used in certain instances in seamless and ERW manufacturing.
<b>TBE</b>	Thread Both Ends
<b>T&amp;C</b>	Threaded and Coupled
<b>TOE</b>	Thread One End
<b>Tensile Strength</b>	Ultimate bursting strength to resist being pulled apart. Expressed in P.S.I.
<b>Victaulic Joint</b>	Pipe is grooved near ends to accommodate a Victaulic coupling.
<b>Yield Strength</b>	The tensile stress required to produce a total elongation of .5 percent of the gauge length as determined by an extensometer. Expressed in P.S I.
<b>XH (XHY)</b>	Extra Heavy (Extra Strong)
<b>XXH (XXHY)</b>	Extra Extra Heavy (Double Extra Strong)

### Decimal Equivalents of Fractions

INCHES	DECIMAL OF AN INCH	INCHES	DECIMAL OF AN INCH	INCHES	DECIMAL OF AN INCH
1/64	0.015625	11/32	0.34375	11/16	0.6875
1/32	0.03125	23/64	0.359375	45/65	0.703125
3/64	0.046875	3/8	0.375	23/32	0.71875
1/16	0.0625	25/64	0.390625	47/64	0.734375
5/64	0.078125	13/32	0.40625	3/4	0.75
3/32	0.09375	27/64	0.421875	49/64	0.765625
7/64	0.109375	7/16	0.4375	25/32	0.78125
1/8	0.125	29/64	0.453125	51/64	0.796875
9/64	0.140625	15/32	0.46875	13/16	0.8125
5/32	0.15625	31/64	0.484375	53/64	0.828125
11/64	0.171875	1/2	0.5	27/32	0.84375
3/16	0.1875	33/64	0.515625	55/64	0.859375
13/64	0.203125	17/32	0.53125	7/8	0.875
7/32	0.21875	35/64	0.546875	57/64	0.890625
15/64	0.234375	9/16	0.5625	29/32	0.90625
1/4	0.25	37/64	0.578125	59/64	0.921875
17/64	0.265625	19/32	0.59375	15/16	0.9375
9/32	0.28125	39/64	0.609375	61/64	0.953125
19/64	0.296875	5/8	0.625	31/32	0.96875
5/16	0.3125	41/64	0.640625	63/64	0.984375
21/64	0.328125	21/32	0.65625	1	1.0
1/3	0.333	43/64	0.671875		

Specifications



## Specifications & Reference Information

### Tap & Drill Sizes

DRILL SIZE	SIZE OF TAP	THREADS PER INCH
7	1/4"	20
F	5/16"	18
5/16	3/8"	16
U	7/16"	14
27/64	1/2"	13
31/64	9/16"	12
17/32	5/8"	11
19/32	11/16"	11
21/32	3/4"	10
23/32	13/16"	10
49/64	7/8"	9
53/64	15/16"	9
7/8	1"	8
63/64	1-1/8"	7
1-7/64	1-1/4"	7
1-13/64	1-3/8"	6
1-11/32	1-1/2"	6
1-29/64	1-5/8"	5-1/2
1-9/16	1-3/4"	5
1-11/16	1-7/8"	5
1-25/32	2"	4-1/2

### Drill Sizes for Pipe Taps

TAP SIZE	THREADS PER INCH	DRILL DIAMETER
1/8"	27	11/32
1/4"	18	7/16
3/8"	18	37/64
1/2"	14	23/32
3/4"	14	59/64
1"	11-1/2	1-5/32
1-1/4"	11-1/2	1-1/2
1-1/2"	11-1/2	1-49/64
2"	11-1/2	2-3/16
2-1/2"	8	2-9/16
3"	8	3-3/16
3-1/2"	8	3-11/16
4"	8	4-3/16
4-1/2"	8	4-3/4
5"	8	5-5/16
6"	8	6-5/16

### Pipe and Water Weight per Line Foot

NOM. PIPE SIZE	STD PIPE	WATER	XH PIPE	WATER
1/2"	0.851	0.132	1.088	0.101
3/4"	1.131	0.231	1.474	0.187
1"	1.679	0.374	2.172	0.311
1-1/4"	2.273	0.648	2.997	0.555
1-1/2"	2.718	0.882	3.632	0.765
2"	3.653	1.453	5.022	1.278
2-1/2"	5.794	2.073	7.662	1.835
3"	7.580	3.200	10.250	2.860
3-1/2"	9.110	4.280	12.510	3.850
4"	10.790	5.510	14.990	4.980
5"	14.620	8.660	20.780	7.880
6"	18.980	12.510	28.580	11.290
8"	28.560	21.680	43.400	19.800
10"	40.500	34.100	54.700	32.300
12"	49.600	49.000	65.400	47.000
14"	54.600	59.700	72.100	57.500
16"	62.600	79.100	82.800	76.500
18"	70.600	101.200	93.500	98.300
20"	78.600	126.000	104.100	122.800
24"	94.600	183.800	125.500	179.900



## Specifications & Reference Information

### Copper Tube Reference Information

Size		Type-K		Type-L / ACR		Type-M		DWV	
Nominal	O.D.	Wall	Lbs/Ft	Wall	Lbs/Ft	Wall	Lbs/Ft	Wall	Lbs/Ft
1/4	3/8	0.035	0.145	0.03	0.125	0.025	0.106	-	-
3/8	1/2	0.049	0.269	0.035	0.198	0.025	0.145	-	-
1/2	5/8	0.049	0.344	0.04	0.285	0.028	0.204	-	-
5/8	3/4	0.049	0.418	0.042	0.362	0.03	0.283	-	-
3/4	7/8	0.065	0.641	0.045	0.455	0.032	0.328	-	-
1	1-1/8	0.065	0.839	0.05	0.655	0.035	0.465	-	-
1-1/4	1-3/8	0.065	1.04	0.055	0.884	0.042	0.682	0.04	0.65
1-1/2	1-5/8	0.072	1.36	0.06	1.14	0.049	0.94	0.042	0.809
2	2-1/8	0.083	2.06	0.07	1.75	0.058	1.46	0.042	1.07
2-1/2	2-5/8	0.095	2.93	0.08	2.48	0.065	2.03	-	-
3	3-1/8	0.109	4	0.09	3.33	0.072	2.68	0.045	1.69
3-1/2	3-5/8	0.12	5.12	0.1	4.29	0.083	3.58	-	-
4	4-1/8	0.134	6.51	0.11	5.38	0.095	4.66	0.058	2.87
5	5-1/8	0.16	9.67	0.125	7.81	0.109	6.66	0.072	4.43
6	6-1/8	0.192	13.9	0.14	10.2	0.122	8.92	0.083	6.1
8	8-1/8	0.271	25.9	0.2	19.3	0.17	16.46	-	-

### Refrigeration Service Tube Reference Information

O.D. Size	1/8	3/16	1/4	5/16	3/8	1/2	5/8	3/4	7/8	1-1/8	1-3/8	1-5/8
Wall Thickness	0.03	0.03	0.03	0.032	0.032	0.032	0.035	0.035	0.045	0.05	0.055	0.06
Weight per foot	0.035	0.575	0.804	0.109	0.134	0.182	0.251	0.305	0.455	0.655	0.884	1.14
Weight per coil	1.74	2.88	4.02	5.45	6.7	9.1	12.55	15.25	22.75	32.75	44.2	57
Coil Diameter	14.75	14.75	14.75	16.5	16.5	20	22	25	27.5	34.5	39.5	42

Specifications





## Specifications & Reference Information

**Pipe Size (IPS) Weights & Wall Thicknesses** (Shaded Row: Wall Thickness, White Row: Weight/Ft)

Pipe Size	O.D. (In)	STD	XH	XXH	10	20	30	40	60	80	100	120	140	160
1/2	0.840	.109	.147	.294	-	-	-	.109	-	.147	-	-	-	.188
		.85	1.09	1.71	-	-	-	.85	-	1.09	-	-	-	1.31
3/4	1.050	.113	.154	.308	-	-	-	.113	-	.154	-	-	-	.219
		1.13	1.47	2.44	-	-	-	1.113	-	1.47	-	-	-	1.94
1	1.315	.133	.179	.358	.109	-	-	.133	-	.179	-	-	-	.250
		1.68	2.17	3.66	1.40	-	-	1.68	-	2.17	-	-	-	2.84
1-1/4	1.660	.140	.191	.382	.109	-	-	.140	-	.191	-	-	-	.250
		2.27	3.00	5.21	1.81	-	-	2.27	-	3.00	-	-	-	3.76
1-1/2	1.900	.145	.200	.400	.109	-	-	.145	-	.200	-	-	-	.281
		2.72	3.63	6.41	2.09	-	-	2.72	-	3.63	-	-	-	4.86
2	2.375	.154	.218	.436	.109	-	-	.154	-	.218	-	-	-	.344
		3.65	5.05	9.03	2.64	-	-	3.65	-	5.02	-	-	-	7.46
2-1/2	2.875	.203	.276	.552	.120	-	-	.203	-	.276	-	-	-	.375
		5.79	7.66	13.69	3.53	-	-	5.79	-	7.66	-	-	-	10.01
3	3.500	.216	.300	.600	.120	-	-	.216	-	.300	-	-	-	.438
		7.58	10.25	18.58	4.33	-	-	7.58	-	10.25	-	-	-	14.32
3-1/2	4.000	.226	.318	-	.120	-	-	.226	-	.318	-	-	-	-
		9.11	12.50	-	4.97	-	-	9.11	-	12.50	-	-	-	-
4	4.500	.237	.337	.674	.120	-	-	.237	-	.337	-	.438	-	.531
		10.79	14.98	27.54	5.61	-	-	10.79	-	14.98	-	19.00	-	22.51
5	5.563	.258	.375	.750	.134	-	-	.258	-	.375	-	.500	-	.625
		14.62	20.78	38.55	7.77	-	-	14.62	-	20.78	-	27.04	-	32.96
6	6.625	.280	.432	.864	.134	-	-	.280	-	.432	-	.562	-	.719
		18.97	28.57	53.16	9.29	-	-	18.97	-	28.57	-	36.39	-	45.35
8	8.625	.322	.500	.875	.148	.250	.277	.322	.406	.500	.594	.719	.812	.906
		28.55	43.39	72.42	13.40	22.36	24.70	28.55	35.64	43.39	50.95	60.71	67.76	74.69
10	10.75	.365	.500	1.000	.165	.250	.307	.365	.500	.594	.719	.844	1.000	1.125
		40.48	54.74	104.13	18.70	28.04	34.24	40.48	54.74	64.43	77.03	89.29	104.13	115.64
12	12.75	.375	.500	1.000	.180	.250	.330	.406	.562	.688	.844	1.000	1.125	1.312
		49.56	65.42	125.49	24.20	33.38	43.77	53.52	73.15	88.63	107.32	125.49	139.67	160.27
14	14.00	.375	.500	-	.250	.312	.375	-	.594	.750	.938	1.094	1.250	1.406
		54.57	72.09	-	36.71	45.61	54.57	-	85.05	106.13	130.85	150.79	170.21	189.11
16	16.00	.375	.500	-	.250	.312	.375	.500	.656	.844	1.031	1.219	1.438	1.574
		62.58	82.77	-	42.05	52.27	62.58	82.77	107.50	136.61	164.82	192.43	223.64	245.25
18	18.00	.375	.500	-	.250	.312	.438	.562	.750	.938	1.156	1.375	1.562	1.781
		70.59	93.45	-	47.39	58.94	82.15	104.67	138.17	170.92	207.96	244.14	274.22	308.50
20	20.00	.375	.500	-	.250	.375	.500	.594	.812	1.031	1.281	1.500	1.750	1.969
		78.60	104.13	-	52.73	78.60	104.13	123.11	166.40	208.87	256.10	296.37	341.09	379.17
24	24.00	.375	.500	-	.250	.375	.562	.688	.969	1.219	1.531	1.812	2.062	2.344
		94.62	125.49	-	63.41	94.62	140.80	171.29	238.35	296.58	367.39	429.39	483.12	542.13
30	30.00	.375	.500	-	.312	.500	.625	-	-	-	-	-	-	-
		118.65	157.53	-	98.93	157.53	196.08	-	-	-	-	-	-	-
36	36.00	.375	.500	-	.312	.500	.625	.750	-	-	-	-	-	-
		142.68	189.57	-	118.92	189.57	236.13	282.35	-	-	-	-	-	-
42	42.00	.375	.500	-	-	-	-	.750	-	-	-	-	-	-
		166.71	221.61	-	-	-	-	330.41	-	-	-	-	-	-
48	48.00	.375	.500	-	-	-	-	.750	-	-	-	-	-	-
		190.74	253.65	-	-	-	-	378.47	-	-	-	-	-	-



## Specifications & Reference Information

### Submittal Data

### ASTM A106 SEAMLESS PRESSURE GRADE A & B PIPE

#### SCOPE

Covers seamless carbon steel Grades A & B pipe for high pressure and high temperature service. Pipe is suitable for bending, flanging, and similar forming operations and for welding. Applications include: Refineries, Power Plants, Boilers, Ship Building, and other specialized applications.

#### HEAT TREATMENT

Hot-finished pipe need not be heat treated. Cold drawn pipe shall be heat treated after the final cold draw pass at a temperature of 1200°F or higher.

#### HYDROSTATIC & NONDESTRUCTIVE ELECTRIC

Testing Hydrostatic inspection test pressure is 2500 psi for sizes NPS 2 and under. Test pressure shall be maintained for a minimum of 5 seconds. When specified by the purchaser, pipe may be tested by the nondestructive electric test in lieu of the hydrostatic test.

#### END FINISH

Plain End: NPS 1-1/2 and smaller shall be either plain end square cut or plain end beveled at the option of the manufacturer. NPS 2 ends shall be beveled to angle 30° +5°, -0° with a root face of 1/16" ± 1/32".

Threaded Pipe: Threads comply with ANSI Standard B 1.20.1

Couplings: Couplings comply with ASTM Standard A 865

#### CHEMICAL REQUIREMENTS, COMPOSITION, MAX. %

Carbon <sup>A</sup>	Manganese	Phosphorus	Sulfur	Silicon
.25	0.27/0.93	.035	.035	.010 Min
Copper <sup>B</sup>	Nickel <sup>B</sup>	Chromium <sup>B</sup>	Molybdenum <sup>B</sup>	Vanadium <sup>B</sup>
.40	.40	.15	.15	.08

A: For each reduction of 0.01% below the specified carbon maximum, an increase of 0.06% manganese above the specified maximum will be permitted up to a maximum of 1.35%

B: The combination of these five elements shall not exceed 1.00%

#### TENSILE REQUIREMENTS

Yield Strength, min 35,000 psi  
 Tensile Strength, min 60,000 psi  
 Elongation in 2" 35% Minimum

#### BENDING TEST (COLD) FOR NPS 2 AND UNDER

Standard 90° Bend, 12 X pipe O.D.

Close Coiling 180° Bend, 8 X pipe O.D.

#### FREQUENCY OF TESTS

Tensile tests and flattening tests are required on one length of pipe from each lot of 400 lengths or fraction thereof for each size.

#### DIMENSIONS AND WEIGHTS

The dimensions and weights furnished under this specification are in agreement with the standardized dimensions and weights specified in ANSI B 36.10.

#### PERMISSIBLE VARIATIONS IN WALL THICKNESS

Minimum wall thickness at any point shall not be more than 12.5% under nominal wall thickness specified. Maximum wall thickness at any point shall not be greater than 20.0% over nominal wall thickness.

#### WORKMANSHIP

Visual imperfections such as scabs, seams, laps or tears shall not exceed 5% of the nominal wall thickness.

#### PERMISSIBLE VARIATIONS IN OUTSIDE DIAMETER

NPS 1-1/2 and under ± 1/64"

NPS 2 ± 1/32"

#### PERMISSIBLE VARIATIONS IN WEIGHT PER FOOT

Pipe shall not vary more than 10% over and 3.5% under the standard specified.

#### PRODUCT MARKING

Each length of pipe is continuously stenciled to show the manufacturer, specification (A106), size (O.D. & wall), "A & B" for Grades A & B, 2500 psi, length and heat number

#### HOT-DIPPED GALVANIZED

Pipe is galvanized to the requirements of ASTM A 53. The average weight of zinc coating shall not be less than 1.8 ounces per square foot of surface (inside and outside). When galvanized pipe is bent or otherwise fabricated to a degree that causes the zinc coating to stretch or compress beyond the limit of elasticity, some flaking of the coating may occur.

**See page 641 for O.D. size, wall thickness and weight per foot information.**

Submittal Data Provided by:

Wheatland Tube Company

Rev 04/27/05



## Specifications & Reference Information

### Submittal Data

#### ASTM A53 GRADE A, TYPE F PIPE

##### SCOPE

Covers black and hot-dipped galvanized furnace-butt welded (continuous welded) Grade A pipe. Pipe is intended for mechanical and pressure applications and is acceptable for ordinary uses in steam, water, gas and air lines. Wheatland ASTM A 53 is UL Listed and FM Approved, sizes 1" through 6" nominal, for use in Fire Sprinkler Pipe Applications. Pipe is suitable for welding, threading, grooving and bending. Pipe is not intended for flanging. Produced to latest revisions of ASTM A53/A53M, Federal Specification WW-P404 and ASME B36.10M.

##### HOT-DIPPED GALVANIZED

The average weight of zinc coating shall be not less than 1.8 oz. per sq. ft. of surface (inside and outside).

When galvanized pipe is bent or otherwise fabricated to a degree which causes zinc coating to stretch or compress beyond the limit of elasticity, some flaking of the coating may occur.

##### HYDROSTATIC TESTING

Hydrostatic test pressures for plain-end pipe are indicated below.

NPS	Standard – PSI	Extra Strong – PSI
1/8" – 3/8"	700	850
1/2" – 1"	1500	1500
1-1/4" – 1-1/2"	2000	2000
2" – 3"	2500	2500
3-1/2" – 4"	2800	2800

##### END FINISH

Plain End: NPS 1-1/2 and smaller: unless otherwise specified on order, end finish shall be at the option of the manufacturer.

NPS 2 and larger: STD and Sch 80 weights: ends beveled to angle of 300, +50, -00 with a root face of 1/16" + 1/32".

Threaded: To ANSI Standard B 1.20.1

Couplings: To ASTM Standard A 865.

##### CHEMICAL REQUIREMENTS

Composition, max. %

Carbon	Manganese	Phosphorus	Sulfur		
.30	1.20	.05	.045		
Copper*	Nickel*	Chromium*	Molybdenum*	Vanadium*	
.40	.40	.40	.15	.08	

\*The combination of these 5 elements shall not exceed 1.00%

##### TENSILE REQUIREMENTS

Tensile Strength, min. 48 000 psi

Yield Strength, min. 30 000 psi.

Elongation in 2" Refer to A 53 Table x 4.1, latest revision – ASTM A53/A 53M

##### BENDING TEST (COLD) FOR NPS 2 and UNDER:

Standard: 90° Bend Diameter, 12 x outside pipe diameter

Close Coiling: 90° Bend Diameter, 8 x outside pipe diameter

##### FLATTENING TEST - NPS 2-1/2 and Greater

As a test for quality of the weld, position the weld at 900 from the direction of force and flatten until the OD is 3/4 of the original outside diameter. No cracks shall occur along the inside or outside surface of the weld.

##### DIMENSIONS and WEIGHTS

###### PERMISSIBLE VARIATIONS IN WALL THICKNESS

Minimum wall thickness at any point shall not be more than 12.5% under nominal wall thickness specified.

###### PERMISSIBLE VARIATIONS IN OUTSIDE DIAMETER

NPS 1-1/2 and under + .016"

NPS 2 and over + 1%

###### PERMISSIBLE VARIATIONS IN WEIGHT PER FOOT

Pipe shall not vary more than + 10% from the standard specified.

##### PRODUCT MARKING

Each length of pipe 1/2 NPS and larger is continuously stenciled to show the manufacturer, the grade of pipe (ASTM A 53), the kind of pipe (F for Continuous Weld, A for Grade A,) the size (Sch 80 for extra strong), and length. Stencil markings indicate UL Listing and FM Approval for sizes 1" through 6" nominal for use in Fire Sprinkler Pipe Applications. Bar Coding is acceptable as a supplementary identification method.

**See page 641 for O.D. size, wall thickness and weight per foot information.**

Submittal Data Provided by:

Wheatland Tube Company

Rev 01/07/05



## Specifications & Reference Information

### Submittal Data

#### ASTM A53 GRADE B, TYPE E PIPE

##### SCOPE

Covers black and hot-dipped galvanized electric-resistance welded Grade B pipe. Pipe is intended for mechanical and pressure applications and is acceptable for ordinary uses in steam, water, gas and air lines. Wheatland ASTM A 53 is UL Listed and FM Approved, sizes 1" through 6" nominal, for use in Fire Sprinkler Pipe Applications. Pipe is suitable for welding, threading and grooving. Produced to the latest revision of ASTM A 53/ 53M, Federal Specification WW-P404 and ASME B36.10M.

##### MANUFACTURE

The weld seam shall be heat treated after welding to a minimum of 1400 OF or be otherwise processed in such a manner that no untempered martensite remains.

##### HOT-DIPPED-GALVANIZED

The average weight of zinc coating shall be not less than 1.8 oz. per sq. ft. of surface (inside and outside).

When galvanized pipe is bent or otherwise fabricated to a degree which causes zinc coating to stretch or compress beyond the limit of elasticity, some flaking of the coating may occur.

##### HYDROSTATIC AND NONDESTRUCTIVE ELECTRIC TESTING

Hydrostatic inspection test pressures for plain-end pipe are listed in Table X 2.2 of the A53/A 53M specification. Test pressures shall be maintained for a minimum of five seconds.

Nondestructive electric testing of the weld seam is required on each length of ERW pipe NPS 2 and larger.

##### CHEMICAL REQUIREMENTS

Composition, max. %

Carbon	Manganese	Phosphorus	Sulfur		
.30	1.20	.05	.045		
Copper*	Nickel*	Chromium*	Molybdenum*	Vanadium*	
.40	.40	.40	.15	.08	

\*The combination of these 5 elements shall not exceed 1.00%

##### TENSILE REQUIREMENTS

Tensile Strength, min. 60 000 psi

Yield Strength, min. 35 000 psi

##### BENDING TEST (COLD)

For NPS 2 and under

Degree of Bend: 90

Diameter of Mandrel: 12 x outside pipe diameter

##### FLATTENING TEST

As a test for ductility of the weld for pipe 2-1/2" NPS and larger, position the weld at 00 and alternately at 90 to the direction of force and flatten until the OD is 2/3 of the original outside diameter. No cracks shall occur along the inside or outside surface of the weld.

##### FREQUENCY OF TESTS

Tensile tests are required on one length of pipe from each lot of 500 lengths or fraction thereof for each size. Refer to A 53 specification for frequency of flattening tests.

##### END FINISH

Plain End: NPS 2 and larger, STD and XS weights: ends beveled to angle of 300, +50, -00 with a root face of 1/16" + 1/32"

**Threaded:** To ANSI Standard B 1.20.1

**Couplings:** To ASTM Standard A 865

##### DIMENSIONS AND WEIGHTS

###### PERMISSIBLE VARIATIONS IN WALL THICKNESS

Minimum wall thickness at any point shall not be more than 12.5% under nominal wall thickness specified.

###### PERMISSIBLE VARIATIONS IN OUTSIDE DIAMETER

Pipe NPS 2 and larger shall not vary more than + 1% from the standard specified.

###### PERMISSIBLE VARIATIONS IN WEIGHT PER FOOT

Pipe shall not vary more than + 10% from the standard specified.

##### PRODUCT MARKING

Each length of pipe is continuously stenciled to show the manufacturer, the grade of pipe (ASTM A 53), the kind of pipe E for Electric Resistance Welded, B for Grade B, the size, XS for extra strong, and length. Stencil markings indicate UL Listing and FM Approval for sizes 1" through 6" nominal for use in Fire Sprinkler Pipe Applications. Bar coding is acceptable as a supplementary identification method.

**See page 641 for O.D. size, wall thickness and weight per foot information.**

Submittal Data Provided by:

Wheatland Tube Company

Rev 04/27/05



## Specifications & Reference Information

### Material Specifications for Carbon Steel Butt Weld Fittings

ASTM Specification A234		
<b>GRADE SYMBOL</b>	WPA Grade A	WPB Grade B
<b>Type of Steel</b>	Carbon	Carbon
<b>Chemical Composition</b>	C-0.25 max.	C-0.30 max.
<b>Minimum Physical Requirements</b>	TS-48,000 YP-30,000	TS-60,000 YP-35,000
<b>Heat Treatment</b>	Cooled in Still Air	Cooled in Still Air

### Material Specifications for Carbon Steel Flanges

	ASTM Specification*			
	A181		A105	
<b>GRADE SYMBOL</b>	I	II	I	II
<b>Type of Steel</b>	Carbon		Carbon	
<b>Chemical Composition</b>	C-0.35 max.		C-0.35 max.	
<b>Minimum Physical Requirements</b>	TS-60,000 YP-30,000	TS-70,000 YP-36,000	TS-60,000 YP-30,000	TS-70,000 YP-36,000
<b>Heat Treatment</b>	Hot forged with finishing temperature above upper critical. Cooler in still air.		Normalized	

\*Material specifications for the ASME Boiler Code are the same ASTM except the letter S is prefixed thereto. A 35% Carbon maximum for flanges with are to be welded have been established by ASTM A181 and A105.

### Grade and Composition Symbols for Carbon Steel Butt-Welding Fittings

<b>WPA</b>	Seamless Pipe	ASTM A106 Grade A
	Plate	ASTM A285 Grade C
	Forgings	ASTM A105 Grade 1
	Bars*	ASTM A107 GR. 1008-1022
<b>WPB</b>	Seamless Pipe	ASTM A106 Grade B
	Plate	ASTM A515 Grade 6S
	Forgings	ASTM A105 Grade 11
	Bars*	ASTM A107 Gr. 1025-1030

\* For fittings 2" nominal size & smaller.



## Specifications & Reference Information

### Templates for Drilling Flanges

Flange diameters and drilling templates of 150-lb bronze flanges are the same as the 125 lb. USA Cast-Iron Standard (B16.1). Flanges diameters and drilling templates of 250-lb and 300-lb. Bronze flanges are the same as the 250-lb. USA Cast-Iron Flange Standard (B16.5) The faces of these flanges are machined with a serrated spiral finish. When cast iron or steel flanges with raised faces are bolted to these flanges, the raised faces should be removed. Full face gaskets should be used. Metallic Gaskets should not be used.

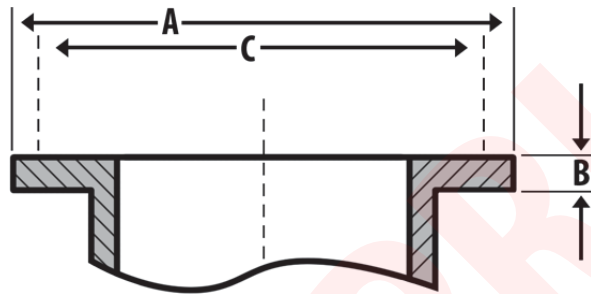

Nominal Size of Pipe Inches	A Outside Diameter of Flange Inches	B Minimum Thickness of Flange Inches	C Diameter of Bolt Circle Inches	Diameter of Drilled Bolt Holes Inches	Diameter of Bolts Inches	Length of Bolts Inches	Number of Bolts
<b>150LB Flanges</b>							
<b>1/2</b>	3 1/2	1/16	2 1/8	5/8	1/2	1 1/4	4
<b>3/4</b>	3 7/8	11/32	2 3/4	5/8	1/2	1 1/2	4
<b>1</b>	4 1/4	3/8	3 1/8	5/8	1/2	1 1/2	4
<b>1 1/4</b>	4 3/8	13/32	3 1/2	5/8	1/2	1 1/2	4
<b>1 1/2</b>	5	7/16	3 7/8	5/8	1/2	1 1/2	4
<b>2</b>	6	1/2	4 3/4	3/4	1/8	1 3/4	4
<b>2 1/2</b>	7	9/16	5 1/2	3/4	1/8	2	4
<b>3</b>	7 1/2	5/8	6	3/4	1/8	2	4
<b>3 1/2</b>	8 1/2	11/16	7	3/4	5/8	2 1/4	8
<b>4</b>	9	11/16	7 1/2	3/4	5/8	2 1/4	8
<b>5</b>	10	3/4	8 1/2	7/8	3/4	2 1/2	8
<b>6</b>	11	13/16	9 1/2	7/8	3/4	2 1/2	8
<b>8</b>	13 1/2	15/16	11 3/4	7/8	3/4	2 1/4	8
<b>10</b>	16	1	14 1/4	1	7/8	3 1/4	12
<b>12</b>	19	1 1/16	17	1	7/8	3 1/4	12

Specifications



## Specifications & Reference Information

Nominal Size of Pipe Inches	A Outside Diameter of Flange Inches	B Minimum Thickness of Flange Inches	C Diameter of Bolt Circle Inches	Diameter of Drilled Bolt Holes Inches	Diameter of Bolts Inches	Length of Bolts Inches	Number of Bolts
<b>250LB Flanges</b>							
<b>1/2</b>	3 3/4	13/32	2 3/8	5/8	1/2	1 1/2	4
<b>3/4</b>	4 1/8	7/16	3 1/4	3/4	3/8	1 3/4	4
<b>1</b>	4 7/8	1/2	3 1/2	3/4	3/8	1 3/4	4
<b>1 1/4</b>	5 1/4	17/32	3 7/8	3/4	3/8	2	4
<b>1 1/2</b>	6 1/8	9/16	4 1/2	7/8	3/4	2	4
<b>2</b>	6 1/2	5/8	5	3/4	3/8	2	8
<b>2 1/2</b>	7 1/2	11/14	5 7/8	7/8	3/4	2 1/4	8
<b>3</b>	8 1/4	7/8	6 5/8	7/8	3/4	2 1/2	8
<b>3 1/2</b>	9	13/16	7 1/4	7/8	3/4	2 1/2	8
<b>4</b>	10	7/8	7 7/8	7/8	3/4	2 1/4	8
<b>5</b>	11	13/16	9 1/4	7/8	3/4	2 1/4	8
<b>6</b>	12 1/2	1	10 3/8	7/8	3/4	3	12
<b>8</b>	15	1 1/8	13	1	3/8	3 1/4	12
<b>10</b>	17 1/2	1 3/16	15 1/4	1 1/8	1	3 3/4	16
<b>12</b>	20 1/2	1 1/4	17 3/4	1 1/4	1 1/8	3 3/4	16

Nominal Size of Pipe Inches	A Outside Diameter of Flange Inches	B Minimum Thickness of Flange Inches	C Diameter of Bolt Circle Inches	Diameter of Drilled Bolt Holes Inches	Diameter of Bolts Inches	Length of Bolts Inches	Number of Bolts
<b>300LB Flanges</b>							
<b>1/2</b>	3 3/4	1/2	2 5/8	3/8	1/2	1 3/4	4
<b>3/4</b>	4 3/8	17/32	3 1/4	3/4	3/8	2	4
<b>1</b>	4 7/8	19/32	3 1/2	3/4	3/8	2	4
<b>1 1/4</b>	5 1/4	5/8	3 7/8	3/4	3/8	2	4
<b>1 1/2</b>	6 1/8	11/16	4 1/2	7/8	3/4	2 1/4	4
<b>2</b>	6 1/2	3/4	5	3/4	3/8	2 1/4	8
<b>2 1/2</b>	7 1/2	13/16	5 7/8	7/8	3/4	2 1/2	8
<b>3</b>	8 1/4	29/32	6 5/8	7/8	3/4	2 3/4	8
<b>3 1/2</b>	9	31/32	7 1/4	7/8	3/4	3	8
<b>4</b>	10	1 1/16	7 7/8	7/8	3/4	3	8
<b>5</b>	11	1 1/8	9 1/4	7/8	3/4	3 1/4	8
<b>6</b>	12 1/2	1 3/16	10 5/8	7/8	3/4	3 1/4	12
<b>8</b>	15	1 3/8	13	1	3/8	3 1/4	12



## Specifications & Reference Information

### Valve Material Selection Guide

This chart is meant to be used as a guide only and is based on average conditions.  
**Not a guarantee of service.**

Valve Material Selection Guide	METALS						SEATS							
	IRON	CAST STEEL	BRONZE	316 S.S.	MONEL	ALLOY 20	BUNA-N	NEOPRENE	EPT	BUTYL	SILICON	HYPALON	VITON	
	<b>A: SATISFACTORY</b>						<b>B: SLIGHT/MODERATE EFFECT</b>		<b>C: MODERATE/SEVERE EFFECT</b>		<b>X: UNSUITABLE</b>		<b>BLANK: UNTESTED</b>	
Acetaldehyde		B	A	A		A	X	X		X	X			
Acetate-Solvents		A	A	A		A								
Acetic Acid 10%			X	A	A	A	A	A		B	B	A	X	
Acetic Acid 80%			X	A		A								
Acetic Acid 100%			X	A		A	X		B	B	B	C	X	
Acetic Anhydride	X	C	X	A	A	A	X	A		B		A	C	
Acetone	A	A	A	A	A	A	X	B	A	B	X	B	C	
Acetyl Chloride				A										
Acetamine	A		A	A										
Acetyline	A	A	A	A	A	A	B	B				B	A	
Acrylonitrile	C		A	A	A	A	X	X					X	
Air	A	A	A	A	A	A	A	A	A	A	A	A	A	
Alcohol	B	B	A	A	A	A	B	B		B		B	A	
Alcohol- Amyl	A	B	A	A	A	A	A	A	A	A		A	A	
Alcohol- Butyl		B	A	A	A	A	A	A			C	A		
Alcohol- Ethyl	A			A	A	A	A			A	B			
Aluminum Acetate						A								
Aluminum Chloride		X	X	B	A	A	A	A		A	A	A	A	
Aluminum Nitrate				A										
Aluminum Sulfate		X	C	B	A	B	A	A		A		A		
Alums 10%	C	C	C	A	C	B	A	A		A		A	A	
Amines						A	A				B			
Amonia Anhydrous	A	A	X	A	B	A	B	A		B		B	C	
Amonia Solutions	A	B	X	A	B	A	A	B		B				
Ammonium Acetate	A													
Ammonium Bicarbonate	A			A	A		A	A		A		A	A	
Ammonium Carbonate	A		A	A	A	A	X	B		B		A	A	
Ammonium Chloride	X	X	X	C	B	A	B	A		B		A	A	
Ammonium Fluoride					A									
Ammonium Hydroxide	B	C	X	A	C	A	A	A		A	B	A	A	
Ammonium Hyposulfite				A	A									
Ammonium Nitrate	A	B	X	A	A	A	A			A		A		
Ammonium Phosphate				A	A					A				
Ammonium Sulfate	C	X	C	B	B	B	A	A		A	A	A	A	
Ammonium Sulfide	A			A										
Amyl Acetate	B	B	A	A	A	A	X	C	X	X		C	C	
Amyl Chloride	A	A	A	A	A	A	C	C			X	C		
Aniline To 80 Degrees	C	B	C	A	A	A	C	C	B	C		B	A	
Anodizing Path	A			A										
Antichlor Solution						A								
Argon (Dry)				A										

Specifications





## Specifications & Reference Information

Valve Material Selection Guide This chart is meant to be used as a guide only and is based on average conditions. <b>Not a guarantee of service.</b>	METALS						SEATS								
	IRON	CAST STEEL	BRONZE	316 S.S.	MONEL	ALLOY 20	BUNA-N	NEOPRENE	EPT	BUTYL	SILICON	HYPALON	VITON		
	<b>A: SATISFACTORY</b>						<b>B: SLIGHT/MODERATE EFFECT</b>			<b>C: MODERATE/SEVERE EFFECT</b>			<b>X: UNSUITABLE</b>		<b>BLANK: UNTESTED</b>
Armeen				A	A										
Arsenic Acids				A		A	A	A		A	A	A			
Asphalt	A	A	A	A	A	A	C	C				C	B		
Barium Carbonate	A						A	A		A		A			
Barium Cyanide		B	C	A		A									
Barium Hydroxide	B	C	X	A	A	A	A	A		A		A			
Barium Sulfide		C	X	A		A	A	A		A		A			
Battery Acid						A									
Beer	C			A	A	A	C	B		B	B	A	A		
Beet Sugar Liquids	A	B	C	A	A	A	A	B		B	B	A	A		
Bentonite	A														
Benzene-Benzol	A	A	A	A	A	A	X	C	C	X		C	B		
Benzaldehyde	A	A	A	A	A	A		C	B	C		C	C		
Benzoic Acid		C	X	A		A									
Beryllium Sulfate						A									
Bicarbonate Liquor	A														
Black Liquor	A						A	A				A			
Black Sulfate Liquor	A	B		A		A	A	A				A			
Blood				A											
Borax Liquors	A	B		A			A	A				A			
Boric Acid	C	B	C	A	A	A	A	A	A			A	A		
Brake Fluids	A														
Brine-Alkaline	A			A	A		B	B				B			
Bromine Solution	X	X	X	B	B		C	C	C			B	A		
Brown Liquor	A														
Butane	A	A	A	A	A	A	A	A	B	C		A			
Butylene	A	A	A	A	A	A	B								
Butadiene	B		X	A	B	A	C	C				C	B		
Butyric Acid				A	B	A	C	C							
Butyl Acetate	A	A	A	A	A	A		C	X			C	C		
Butyl Amine	A			A											
Butyl Chloride					A										
Butyl Ether (Dry)	A				A										
Cadmium Plating Bath	A														
Calcium Bisulfite	X	C	C	B	B	B	A	A		A		A	A		
Calcium Chloride	C	B	A	B	A	B	A	A		A		A			
Calcium Chlorate				A		A									
Calcium Hydroxide	B	B	X	A	A	A	A	A		A		A			
Calcium Phosphate	A														
Calcium Silicate	A														
Calcium Sulfate	A	B	A	A		A	A	A		A		A			



## Specifications & Reference Information

### Valve Material Selection Guide

This chart is meant to be used as a guide only and is based on average conditions. **Not a guarantee of service.**

Valve Material Selection Guide	METALS						SEATS					
	IRON	CAST STEEL	BRONZE	316 S.S.	MONEL	ALLOY 20	BUNA-N	NEOPRENE	EPT	BUTYL	SILICON	HYPALON

**A:** SATISFACTORY    **B:** SLIGHT/MODERATE EFFECT    **C:** MODERATE/SEVERE EFFECT    **X:** UNSUITABLE    **BLANK:** UNTESTED

Camphor													
Cane Sugar Liquors	B	A	A	A	A	A	A	B				B	B
Carbitol	A			A									
Carbolic Acid (Phenol)		C	C	A		A							
Carbon Bisulfide	B	B	B	A	A	A	C	C				C	A
Carbon Dioxide	A	A	A	A	A	A	B	A				A	
Carbon Disulfide				A		A	C	C		C		C	
Carbon Monoxide	A							A				A	
Carbon Tetrachloride	B	C	B	A	A	A	A	C	C	X	X	C	A
Carbonic Acid		C	C	A		A							
Carbonated Beverages				A			A	A		A		A	
Casein	A			A	A								
Castor Oil	A			A			A	A		B		A	
Catsup				A	A		A						
Caustic Solutions		B	X	A		A							
Cellulose Acetate	A		A	A									
Chloracetic Acid	C		B	C	B	A	C	A				A	C
Chlorinated Solvents	A			A									
Chlorine (Dry)	B	C	C	B	B	A	C	B	X			B	A
Chlorine (Wet)	X	X	X	X	X	X	C	C	X			B	
Chlorobenzene	A	B	A	A	A	A	X	X	X			X	A
Chloroform (Dry)	A	B	A	A		A	C	C	C	X		C	A
Chlorophyll	A			A	A								
Chlorosulfonic Acid (Dry)		B	B	B	B	A		C	X	X		C	X
Chlorosulfonic (Wet)	X	X	X	X	X	X		C	X	X		C	X
Chrome Alum				A		A							
Chrome Liquor						A							
Chromic Acid 10%	C	X	X	A	B	A	C	C		C		A	
Chromic Acid 50%	C	X	X	C	C	B	C	C		C		A	
Chromium Sulfate				A		A							
Citric Acid	C	X	C	A	A	A	A	A		B		A	
Coal Tar	A			A	A	A	B	C	X	C		C	
Coconut Oil	A						A	B		B		B	
Coffee				A	A	A	A	A		A		A	
Coke Oven Gas	A	B	C	A		A						A	
Condensate	A												
Cooking Oil	B		B	A	A		A	B				B	A
Copper Acetate		X	X	A		A							
Copper Chloride	C		C	B	B		A	A		A		A	
Copper Cyanide	A												
Copper Sulfate	C	C	X	A	A	A	A	A				A	

Specifications



## Specifications & Reference Information

Valve Material Selection Guide This chart is meant to be used as a guide only and is based on average conditions. <b>Not a guarantee of service.</b>	METALS						SEATS						
	IRON	CAST STEEL	BRONZE	316 S.S.	MONEL	ALLOY 20	BUNA-N	NEOPRENE	EPT	BUTYL	SILICON	HYPALON	VITON
	<b>A: SATISFACTORY    B: SLIGHT/MODERATE EFFECT    C: MODERATE/SEVERE EFFECT    X: UNSUITABLE    BLANK: UNTESTED</b>												
Core Oil	A												
Corn Kernels				A	A								
Corn Oil				A	A		A	A		B		A	
Corn Syrup				A	A		A	A		B		A	
Creosote	A	B	B	A	A	A	B	C	X		C	C	A
Cresylic Acid 50%				A	A	A	C	C		C			
Cyanide Solution	A												
Cyanogens Gas				A									
Cyclo Hexane	A	A	A	A	A	A	A	C	C	X		C	A
Deionized Water				A									
Detergents	A			A									
Developer-Photo				A	A								
Dextrin				A	A								
Diacetone Alcohol	A	A	A	A	A	A	C	B			B	B	
Dichlord Ethyl Ether					A	A							
Diester Lube's	A			A									
Diethylamine	A	A	A	A	A	A	A						
Diethyl Sulfate					A	A							
Diethylene Glycol	A						A	A		B		A	
Dimethyl Formamide					A	A							
Dioxane (Dry)	A						A	B		B		B	
Dipentene-Pinene				A		A	A			B			
Dowtherms	A	A	A	A	A	A	X	B				B	A
Dyes (General)	A	A	A	A	A	A							
Enzyme Solution				A		A							
Ethers (Butyl)	A	A	A	A	A	A	C	C		C		C	C
Ethyl Acetate	B	B	B	A	A	A	C	C	C	C		C	C
Ethyl Acrylate				A									
Ethyl Alcohol		B	A	A		A	A	A	A	A	B	A	A
Ethyl Bromide				A	A	A							
Ethyl Chloride (Dry)	A	A	A	A	A	A	B	B	X	B		B	
Ethyl Chloride (Wet)						A	C	C		C		C	
Ethyl Silicate	A			A			A						
Ethylene				A	A		A			B			
Ethylene Glycol	A	A	A	A	A	A	A	A	A	A		A	A
Ethylene Oxide				A		A	X	X	X			X	C
Fatty Acids	C	B	B	A	A	A	B	B				B	A
Ferric Chloride Sol.		X	X	C		C	B	B		B		B	
Ferric Nitrate				A		A		A		A		A	
Ferric Sulfate (DIL)	C		C	B	C	A	A	A		A		B	A
Ferrous Chloride		X	X	B			A	A		A		A	



## Specifications & Reference Information

Valve Material Selection Guide This chart is meant to be used as a guide only and is based on average conditions. <b>Not a guarantee of service.</b>	METALS						SEATS						
	IRON	CAST STEEL	BRONZE	316 S.S.	MONEL	ALLOY 20	BUNA-N	NEOPRENE	EPT	BUTYL	SILICON	HYPALON	VITON
	<b>A: SATISFACTORY    B: SLIGHT/MODERATE EFFECT    C: MODERATE/SEVERE EFFECT    X: UNSUITABLE    BLANK: UNTESTED</b>												
Ferrous Sulfate 10%		C		A	A	A	A	A		A		A	
Ferrous Sulfate 100%		X	X	A	A	A	A	A		A		A	
Fertilizer Solution	A			A	A								
Fish Oil	A			A	A		A						
Flue Gas	A			A		A							
Fluoride Salts				A									
Fluorine (Dry)	X	X	X	X	B	B							
Formaldehyde (Cold)	B	C	A	A	A	A	A	A		A		A	A
Formic Acid	C		B	A	B	A	C	A		B		A	C
Freon (Most)	B	B	B	A	A	A	A	A	X			A	A
Fruit Juices	C		B	A	A	A	A	A		A		A	A
Furfural	A		B	A	A	A	C	B		C		B	C
Furnace Gas	A												
Gallic Acid 5%				A		A	A	A		A		A	
Gas-Natural	A		A	A	A	A	A	A				A	A
Gasoline-Motor	A	A	A	A	A	A	A	B	C	X	X	B	A
Gelatin		B	C	A	A	A	A	A		A		A	
Glucose	B	A	A	A	A	A	A	A		A		A	A
Glue (Most)	A	A	A	A	A	A	A	A		A		A	
Glycerin	B			A	A	A	A	A		A		A	A
Glycerol	B	B	B	A	A	A	A	A		A		A	A
Glycolic Acid				A	A	A							
Glyoxal				A									
Glycol Amine				A	A	A							
Graphite	A			A	A								
Grease-Edible				A			A						
Green Liquor				A								B	A
Helium Gas	A												
Heptanes-Hexane	A	A	A	A	A	A	A	A		C		A	A
Heachlorobenzene					A	A							
Hexanol-Tertiary	A	A	A	A	A	A				C			
Hydrazine													
Hydrobromic Acid	X	X	X	X	X	X	A	A				A	
Hydrochloric Acid (Cold)	X	X	X	X	X	X	X	A		B	B	A	A
Hydrocyanic Acid	C		X	A	B	A	B	A				A	
Hydrofluoric Acid	X	C	X	X	B	C	B	A		B		A	
Hydrofluosilic Acid		X	A	C	B	B	A	A				A	
Hydrogen Gas	A	B	B	A	A	A	A	A				A	
Hydrogen Peroxide	C	X	X	A	B	B	B	B			B	A	A
Hydrogen Sulfide (Dry)	A	X	X	A	A	A	B	A				A	

Specifications



## Specifications & Reference Information

Valve Material Selection Guide This chart is meant to be used as a guide only and is based on average conditions. <b>Not a guarantee of service.</b>	METALS						SEATS						
	IRON	CAST STEEL	BRONZE	316 S.S.	MONEL	ALLOY 20	BUNA-N	NEOPRENE	EPT	BUTYL	SILICON	HYPALON	VITON
	<b>A: SATISFACTORY    B: SLIGHT/MODERATE EFFECT    C: MODERATE/SEVERE EFFECT    X: UNSUITABLE    BLANK: UNTESTED</b>												
Hydrogen Sulfide (Wet)	C	X	X	B	B	B	C	B		B		B	
Illuminating Gas	A	A	A	A	A	A							
Iodine Solution	X	X	X	B	B		B	B					A
Iron Oxide	A												
Iso-Octane	A	A	A	A	A	A	A	A				A	
Isopropyl Alcohol	A	A	A	A	A	A	B	A		B		A	A
Isopropyl Ether	A	A	A	A	A	A	A	C	X			B	
Jet Fuels	A		A	A	A		A	C	X	X		C	A
Juices – Fruit				A									
Kelp Slurry	A												
Kerosene	A	A	A	A	A	A	A	B	X	X		B	A
Lacquers-Solvents	A	A	A	A	A	A	C	C		C		C	C
Lactic Acid (Diluted)	C	X	X	A	B	A	B	A		B		A	
Lactic Acid 100%	C	X	X	B	B	A	B	A		B		A	
Lactose				A	A								
Lead Sulfate	A												
Lecithin				A		A							
Lime-Sulphur Mix				A	A		A	A				A	
Linoleic Acid				A		A							
Linseed Oil	A		B	B	B		A	A		A		A	A
Lithium Chloride					A								
Ludox				A		A							
Magnesium Bisulfate			A		A								
Magnesium Carbonate	A												
Magnesium Chloride	C	C	C	B	A	A	A	A		A		A	
Magnesium Sulfate (Liq)	A	A	A	A	A	A				A			
Maleic Acid				A	A	A	A	A		A		A	
Maleic Anhydride				A		A	A			A			
Malt Slurry				A	A		A	A				A	
Manganese Sulfate						A							
Mannitol Solution				A									
Menthol				A									
Mercuric Chloride	X	X	X	B	B	B	B	A				A	
Mercuric Cyanide				A		A							
Mercupic Nitrate				A									
Mercury	A	A	X	A	B	A	A	A		A		A	
Menthane (Use Butane)													
Methyl Acetate	A	B		A		A	C	C				C	
Methyl Acetone	A	A	A	A	A	A							
Methyl Alcohol	A	A	A	A	A	A	A	A		B		A	B
Methyl Bromide				A									



## Specifications & Reference Information

### Valve Material Selection Guide

This chart is meant to be used as a guide only and is based on average conditions. **Not a guarantee of service.**

Valve Material Selection Guide	METALS						SEATS						
	IRON	CAST STEEL	BRONZE	316 S.S.	MONEL	ALLOY 20	BUNA-N	NEOPRENE	EPT	BUTYL	SILICON	HYPALON	VITON

**A:** SATISFACTORY    **B:** SLIGHT/MODERATE EFFECT    **C:** MODERATE/SEVERE EFFECT    **X:** UNSUITABLE    **BLANK:** UNTESTED

Methylamine		A	X	A		A							
Methyl Cellosolve	A	A	A	A	A	A	C	B		B		B	
Methyl Chloride (Wet)	B	B	B	A	A	A	C	C			X	C	
Methyl Ethyl Ketone	B	B	B	A	A	A	X	X	A	B		X	C
Methyl Formate			A										
Methylene Chloride	B	B	A	A	B	A	C	C	B			C	B
Milk	C		B	A	A	A	A	A		A		A	A
Mineral Oil	A		A	A	A		A	A	X	A		A	
Mixed Acids (Cold)	C	X	X	A	B	A	X	X					A
Molasses	A	B	B	A		A	A	A		A		A	A
Monochlor Acetic Acid					A			B				B	
Morpholine	A			A									
Naphtha	A	A	A	A	A	A	A	C	C	C		C	A
Naphthaline	A	A	A	A	A	A	X	C	X	X		C	
Natural Gas	A	A	C	A	A	A	A	A				A	
Nickel Ammonia Sulfate				A									
Nickel Chloride				C		B	A	A				A	
Nickel Sulfate				A	B	A	A	A		A		A	
Nicotinic Acid			B	A	A								
Nitric Acid 10%	C	X	X	B	B	A	C	B	C	B	B	A	A
Nitric Acid 80%	X	X	X	B	B	A	X	C	C	X	X	B	A
Nitric Acid Anhydrous		X	X	A		A							
Nitrobenzene	A			A	A	A	C	C	A	B		C	B
Nitrogen Gas	A												
Nitrous Gases		B	X	A	B	A							
Oils, Animal	A	A	A	A	A	A	A	B				B	
Oil, Cottonseed				A	A	A	A	A	B	C		A	A
Oil, Fish	A		C	A	A	A	A	B				B	
Oil, Fuel	A	A	B	A	A	A	A		X	C			
Oil, Lube	A	A	A	A	A	A	A		X	C			
Oil, Mineral	A	A	A	A	A	A	A	A	X	X		A	
Oil, Petroleum		A	B	A	A	A	A			C			
Oleic Acid	C	B	X	A	A	A	A	B		C		B	B
Oleum Spirits	C	X	X	A	B	A	C	C		C		C	A
Oxalid Acids (Cold)	C	X	X	A	B	A	C	A		B		B	A
Oxygen	A	B	A	A	A	A	B	B		B		B	
Ozone (Dry)		A		A	A	A							
Ozone (Wet)				A	A								
Paints-Solvents	A	A	A	A	A	A							
Palmitic Acid	C		B	A	A	A	B	B				B	A
Paper Pulp	A			A	A								

Specifications



## Specifications & Reference Information

Valve Material Selection Guide This chart is meant to be used as a guide only and is based on average conditions. <b>Not a guarantee of service.</b>	METALS						SEATS						
	IRON	CAST STEEL	BRONZE	316 S.S.	MONEL	ALLOY 20	BUNA-N	NEOPRENE	EPT	BUTYL	SILICON	HYPALON	VITON
	<b>A: SATISFACTORY    B: SLIGHT/MODERATE EFFECT    C: MODERATE/SEVERE EFFECT    X: UNSUITABLE    BLANK: UNTESTED</b>												
Paraffin Oils	A				A		A	A				A	
Perchlorethylene	A	A	B	A	A	A	A	X				C	A
Permanganic Acid				A									
Peroxide Bleach				A	A								
Phenol	C		B	A	B	A	X	B		B		B	A
Phenolic Glue	A												
Phosphoric Acid 10%		X	X	A	A	A	A			B		A	
Phosphoric Acid 50%	C	X	X	B	C		A	A				A	A
Phosphoric Acid 100%		X	X	B	A		X	A	A	B		A	
Phosphoric Molten				A		A							
Photographic Solution				A	B								
Picric Acid Solution	C		B	A	A	A	B	A		B		A	
Pine Oil	A			A	A	A	A	B					A
Plasma				A									
Polysulfide Liquor	A			A									
Polyvinyl Chloride				A									
Potassium Acetate				A			A						
Potassium Bromide				A			A	A		A		A	
Potassium Carbonate	A			A	A		A	A		A		A	
Potassium Chloride SOL.	A		A	B	A	A	A	A		A		A	
Potassium Chromate				A			A	A				A	
Potassium Cyanide SOL.	A	A	X	A	A	A	A	A				A	
Potassium Dichromate	A		C	A	A	A	A	A		A		A	
Potassium Hydroxide	A		X	A	A	A	A	A		A		A	
Potassium Nitrate	A	A	B	A	A		A						
Potassium Phosphate				B			A	A		A			
Potassium Sulfate	A	A	A	A	A	A	A	A				A	
Potassium Sulfide	A	A		A		A							
Potassium Sulfite				A		A							
Propane Gas	A	A	A	A	A	A	A	A				A	A
Propyl Alcohol	A	A	A	A	A	A	A	A				A	
Propyl Bromide						A							
Propylene Glycol				A									
Pyrole				A	A	A							
Resins	A	C	A	A	A	A	C	C					
Road Oils	A	A	A	A	A	A	B	C					A
Salad Oils				A		A							
Salicyclic Acid				A	A		A	A				A	
Salt. Brine	B		A	A	A		A	A				A	A
Sea Water	C	C	A	B	A	A	A	A		A		A	A
Sewage	A			A	A								



## Specifications & Reference Information

### Valve Material Selection Guide

This chart is meant to be used as a guide only and is based on average conditions.  
**Not a guarantee of service.**

Valve Material Selection Guide	METALS						SEATS						
	IRON	CAST STEEL	BRONZE	316 S.S.	MONEL	ALLOY 20	BUNA-N	NEOPRENE	EPT	BUTYL	SILICON	HYPALON	VITON
	<b>A: SATISFACTORY    B: SLIGHT/MODERATE EFFECT    C: MODERATE/SEVERE EFFECT    X: UNSUITABLE    BLANK: UNTESTED</b>												
Shellac	A	A	A	A	A	A							
Silicon Fluids	A				A								
Silver Iodine				A	A								
Sodium Acetate	A	B	A	A		A							
Sodium Aluminate	A	A		A	A	A	A	A		A		A	
Sodium Arsenate	A												
Sodium Bichromate				A		A							
Sodium Bisulfate				A		A	A	A		A		A	
Sodium Carbonate SOL.	A	B	B	A	A	A	A	B		B	B	B	A
Sodium Chlorate						B							
Sodium Chloride	A	B	A	A	A	A	A	B		B	B	B	A
Sodium Cyanide	A	A	X	A	A	A	A	A				A	
Sodium Fluoride	A			A									
Sodium Hydrosulfide				A	A								
Sodium Hydroxide 20%	A	B	A	A	A	A	A	A	A	A	B	A	A
Sodium Hydroxide 50%	A	B	A	A	A	A	A	A		A	B	A	A
Sodium Hydroxide 70%	A		A	A	A	A	A	B		A		A	
Sodium Hypochlorite 20%	X	X	X	B		C			A			A	A
Sodium Metaphosphate			C	A	A	A	A	A	A			A	
Sodium Metasilicate	A			A	A		A	A				A	
Sodium Nitrate	A	A	B	A	A	A	A	A		A		A	
Sodium Perborate			C	A		A	A	A				A	
Sodium Peroxide	C		C	A	A	A	B	A				A	
Sodium Phosphate	A			A	A	A	A						
Sodium Silicate	A		C	A	A		A	A					
Sodium Sulfate		A	A	A	A	A	A						
Sodium Sulfide	A	A	X	A	A	A	A	A				A	A
Sodium Sulfite				A	A	A							
Sodium Thiosulfate			X	A	A	A	A	A				A	
Soybean Oil	A		B	A	A		A	A				A	A
Starch	A			A	A		A	A				A	
Steam_Low Pressure	A		A	A	A		C	C	A		A	B	B
Stearic Acid	C	C	C	A	A	A	A	B		C		B	
Styrene (Dry)	A	A	A	A	A	A	X						
Sulfamic Acid						A							
Sulfite Liquor				A									
Sulfonic Acids						A							
Sulphur	C	C	X	B	A	A	B	A	A			A	A
Sulphur Dioxide (Dry)	A	A	A	A	A	A	A	A			B	A	
Sulphur Trioxide (Dry)	A	A	A	A	A	A		C				C	
Sulfuric Acid 10%	X	X	X	A		A	A	A		A	B	A	A

Specifications





## Specifications & Reference Information

Valve Material Selection Guide This chart is meant to be used as a guide only and is based on average conditions. <b>Not a guarantee of service.</b>	METALS						SEATS						
	IRON	CAST STEEL	BRONZE	316 S.S.	MONEL	ALLOY 20	BUNA-N	NEOPRENE	EPT	BUTYL	SILICON	HYPALON	VITON
	<b>A: SATISFACTORY    B: SLIGHT/MODERATE EFFECT    C: MODERATE/SEVERE EFFECT    X: UNSUITABLE    BLANK: UNTESTED</b>												
Sulfuric Acid 75%				B	B	B	X	B					A
Sulfuric Acid 100%	B			A	A	A	X	C	C	X	X	A	A
Sulfurous Acid	C		X	B	C	A	C	X				A	A
Tall Oil	A			A	A	A							
Tannic Acid	B			A	A	A	B	A		A		A	A
Tar	A	A	A	A	A	A				X	X		
Tartaric Acid		B	B	A	A	A	A	A		B		A	
Toluoul-Toluene	A	A	A	A	A	A	X	C	C	C		C	B
Tributyl Phosphate				A	A	A	C	C	X			C	C
Trichloroethylene				A	A	A		C				C	A
Tung Oil	A		A	A	B		A	A				A	A
Turpentine	A	C	B	A	A		A	C	C	B		C	A
Varnish	A	C	A	A	A	A				B			
Vinegar				A	B	A	A	A				A	
Vinyl Acetate				A									
Water, Fresh	A	A	A	A	A	A	A	A	A	A	A	A	A
Water, Heavy				A	A				A				
Water, Mine Acid				A	A	A			A				
Water, Distilled				A	A	A		A	A	A	A	A	B
Water, PH7 OR OVER	A							A	A			A	A
Water, Salt			A	B	A	A	A	A		A		A	A
Waxes	A	A	A	A	A	A	A	B					A
Whiskey	X		B	A	A	A	A	A				A	A
White Liquor	A												
Xylene-Xylol	A	A	A	A	A	A	X	X	C	X		C	A
Zinc Acetate				A			A	A				A	
Zinc Bromide				A									
Zinc Chloride	C	X	C	B	A	A	A	A		A		A	A
Zinc Sulfate			A	A	A	A	A						

### IMPORTANT NOTICE/DISCLAIMER

The data set forth herein is provided "as is". Metropolitan Pipe and the authors of and contributors to this publication specifically deny any warranty or representation, expressed or implied, for the accuracy and/or reliability of the fitness for any particular use of information contained herein or that any data is free from errors.

Constants: 70F temperature, 100% concentration unless otherwise specified.

Mixed chemicals may produce different results as on an individual basis.



**Metropolitan Pipe & Supply**  
Plumbing • Heating • PVF • Industrial Supplies

## **Specifications & Reference Information**

EXPIRED PRICING

Specifications



## Product Index

### A

<b>A Y McDonald</b>	
Bronze Gas Stop Valves.....	358
Bronze Radiator Valves.....	358
<b>Abrasive Products</b> Mill-Rose.....	599
<b>Absorbants</b> Oil-Dri® Premium.....	545
<b>Acetylene Components</b> TurboTorch.....	595
<b>Acetylene Kits</b> Lenox.....	597
<b>Acid Brushes</b> Mill-Rose.....	547, 599
<b>Acid Waste Couplings</b> Orion Fittings.....	398
<b>Acid Waste Fittings</b> Orion Fittings.....	398
<b>Acid Waste Pipe</b> Orion Fittings.....	398
<b>Act-O-Matic</b> Sloan Showerhead.....	72
<b>Actuators</b>	
Honeywell Thermostatic Valve.....	292
ProRadiant.....	491
<b>Adapters</b>	
Mill-Rose Chuck.....	546
Mill-Rose Power Brush.....	546
<b>Add-A-Valve®</b> Jomar.....	360
<b>Aerators</b>	
Neoperl.....	170
Wal-Rich Corporation.....	170
<b>Air Eliminators</b> SpiroTherm.....	250
<b>Air Filters</b> Watts FluidAir Compressed.....	296
<b>Air Gaps</b> Watts Regulator.....	149
<b>Air Purgers</b> Watts.....	219
<b>Air Releases</b> SpiroTherm.....	249-250
<b>Air Treatment</b> Watts FluidAir Compressed.....	296
<b>Air Valves</b>	
Dole Controls.....	248
Maid-O-Mist.....	249
PlumBest®.....	251
Vent-Rite Company.....	250
<b>Air Vents</b>	
Armstrong®.....	248
Bell & Gossett.....	249
Heat-Timer VariValve®.....	248
Taco Inc Automatic.....	250
<b>Alarms</b> SpeedFill.....	254
<b>Allura™ Shower Systems</b> Symmons.....	65
<b>Alsons</b>	
Hand Showers.....	74
Shower heads.....	72
<b>Aluminum Wrenches</b> Ridgid.....	555
<b>American</b> Cast Iron Ball Valves.....	308
<b>Anaco</b>	
Gaskets.....	425
No-Hub Couplings.....	425
<b>Angle Fittings</b> .....	519
<b>Anti-Freeze</b> Hercules®.....	600
<b>Anti-seize Compound</b> JC Whitlam Nickel.....	607

<b>Apollo</b>	
Bronze Ball Valves.....	297
Instrumentation Valves.....	355
Press Ball Valves.....	303
Specialty Valves.....	303
Stainless Steel Ball Valves.....	306
Steel Ball Valves.....	304
<b>Apollo Valves</b> Y-Strainers.....	151
<b>Appliance Connectors</b>	
BrassCraft® Corrugated SS Coated.....	182
Fluidmaster®.....	176
Supr-Safe® Corrugated SS Coated.....	182
<b>Applicator Brushes</b> Mill-Rose.....	547, 599
<b>Aquapure</b>	
Parts & Accessories.....	17
Water Filters.....	14-17
<b>Aquastats®</b> Honeywell.....	285
<b>Aquastat® Well Assemblies</b> Honeywell.....	286
<b>Aquatherm PPR Fusion Piping System</b> .....	426
<b>Aquatic</b>	
Showers.....	123
Tub & Shower Units.....	124
<b>Arbors</b> Lenox Hole Saw.....	590
<b>Ariston</b> Water Heaters.....	200
<b>Arms</b> Highway.....	157
<b>Armstrong®</b>	
Air/Gas Vents.....	248
Disc Steam Traps.....	243
Float & Thermostatic Steam Traps.....	244
Inverted Bucket Steam Traps.....	243
Parts.....	244
Steam Traps.....	243, 245
Temperature & Pressure Controls.....	290
<b>Arrestors</b> Watts Regulator.....	153
<b>Asphalt Paint</b> Hercules®.....	612
<b>Augers</b>	
General Wire Spring Co Closet.....	529
General Wire Spring Co Flexicore Wire Rope Center.....	529
General Wire Spring Co Urinal.....	529
<b>Aviation Snips</b>	
Lenox.....	538
Midwest Snips.....	538
<b>AY McDonald</b>	
Fittings.....	481
Industrial Radiator & Steam Valves.....	270

### B

<b>Babbitt Steam Specialty Co.</b>	
Chain.....	361
Chainwheel Attachments.....	361
Chainwheels.....	361
<b>Backflow Preventers</b>	
Watts Regulator.....	144
Watts Regulator Test Kit.....	147
<b>Backwater Valves</b> .....	424

Prices & specifications are subject to change.

Our state of the art pipe shop offers cutting, threading, grooving and make-ons up to 36in!



## Product Index

Index

<b>Bags</b> PlumBest® Trash.....	539	<b>Benders</b> Ridgid Lever.....	564
<b>Balancing Valves</b>		<b>BernzOmatic®</b> Torches.....	594
Bell & Gossett.....	270	<b>Bibb Screws</b>	
Watts Regulator.....	152	Gunk® Brass.....	163
<b>Ball Valves</b>		Gunk® Monel.....	163
American Cast Iron.....	308	<b>Bit Holders</b> Irwin® Industrial Tools Magnetic.....	584
Apollo Bronze.....	297	<b>Bits</b>	
Apollo Stainless Steel.....	306	Champion Cutting Tool Corp Masonry Drill....	583
Apollo Steel.....	304	Irwin® Industrial Tools Fastener Drive Sets ...	584
Spears CPVC.....	310	Irwin® Industrial Tools Hammer.....	585
Spears PVC.....	309-310	Irwin® Industrial Tools Insert.....	584
<b>Ballcock Rods</b> Wal-Rich Corporation Brass.....	180	Irwin® Industrial Tools Magnetic Holders.....	584
<b>Ballcocks</b>		Irwin® Industrial Tools Metal Twist.....	585
Cesco Brass Burlington.....	173	Irwin® Industrial Tools Power.....	584
Fluidmaster®.....	174	Irwin® Industrial Tools Spade.....	586
<b>Band Hangers</b> .....	520	Irwin® Industrial Tools Woodboring.....	585
<b>Band Saw Blades</b> Lenox.....	582	Lenox Drill Vari-Bit®.....	586
<b>Band Saws</b> Milwaukee®.....	582	Lenox Wood Kits.....	586
<b>Bar Faucets</b>		Sammy Super Screw™.....	526
Elkay.....	30	<b>Black Cast Iron</b>	
Gerber.....	31	Fittings 125# Flanged.....	437
<b>Bar Sinks</b> Elkay Stainless Steel.....	127	Fittings 125# Threaded.....	435
<b>Barnes &amp; Jones</b>		Fittings 250# Flanged.....	438
Float Valves.....	246	Fittings 250# Threaded.....	437
Repair Kits.....	247	<b>Black Malleable Iron</b>	
Steam Trap Repair Elements.....	246	Fittings 150# Threaded.....	438
Thermostatic Steam Traps.....	246	Fittings 300# Threaded.....	442
Tools.....	247	<b>Black Pipe</b>	
Wrenches.....	247	Steel.....	433
<b>Baseboard Heating</b> Slant/Fin.....	271-272	Steel Seamless.....	433-434
<b>Basin Nut Wrenches</b> Wal-Rich Corporation.....	542	<b>Black Steel Fittings</b> Pipe Nipples.....	460, 462-463
<b>Basin Wrenches</b> Ridgid.....	556-557	<b>Blades</b>	
<b>Bath Drains</b> Gerber.....	169	Lenox Band Saw.....	582
<b>Bathcock Couplings</b> Wal-Rich Corporation.....	180	Lenox Handsaw.....	588
<b>Bathroom Cleaners</b> Chemique.....	604	Lenox Saw.....	592
<b>Bathtub Protectors</b> Oatey.....	171	Ridgid Tubing Cutter.....	560
<b>Bathtubs</b> Kohler Select.....	120	<b>Block Cement</b> .....	545
<b>Batteries</b> Duracell.....	553	<b>Blow Down Valves</b> McDonnell & Miller.....	240
<b>Beacon-Morris®</b> Twin-Flo III® Kickspace Heaters	276	<b>Blow-Off Valves</b>	
<b>Bead Chain Couplings</b> Wal-Rich Corporation.....	172	Edwards Steel.....	354
<b>Beaded Chain</b> Wal-Rich Corporation.....	172	Lunkenheimer Bronze.....	354
<b>Beam Clamps</b> .....	518	<b>Boiler Brushes</b> Mill-Rose.....	547
<b>Beam Hangers</b> Flanged.....	521	<b>Boiler Cement</b> Hercules®.....	603
<b>Bearings Assemblies</b> Bell & Gossett.....	267	<b>Boiler Cleaners</b>	
<b>BearTrap®</b> Steam Traps Hoffman Specialty.....	247	Hercules®.....	600
<b>Bed Pan Cleaner</b> Flushometers Sloan Valve.....	83	Silver King Mfg.....	600
<b>Bell &amp; Gossett</b>		<b>Boiler Controls</b>	
Circuit Setter® Balance Valves.....	270	McDonnell & Miller.....	238-239
Circulator Pumps.....	265	McDonnell & Miller Switches.....	240
Flanges.....	266	<b>Boiler Drain Valves</b> Everlasting Iron.....	353
Flow Valves.....	270	<b>Boiler Feed Units</b> Hoffman Specialty.....	242
Hydronic Valves.....	249	<b>Boiler Relief Valves</b> Watts Regulator.....	143
Motor Accessories.....	266	<b>Boiler Seal</b> Gunk®.....	601
Pressure Reducing Valves.....	270	<b>Boiler Stop-Leaks</b> Hercules®.....	601
Pump Motors.....	266	<b>Boiler Valves</b>	
Pump Parts.....	267	Raven Brass.....	359
<b>Bench Vises</b> Ridgid.....	531	United Bronze.....	353
		Watts Regulator Fill.....	152

Prices & specifications are subject to change.



## Product Index

Watts Water Feeder .....	152
<b>Boiler/DHW Controls</b> tekmar® Controls.....	236
<b>Boilers</b>	
Gas.....	222, 227-230
Lochinvar.....	227-230
Natural Gas.....	221
Oil.....	223-226
Power Vent.....	222
Weil-McLain.....	221-225
Weil-McLain Commercial .....	231
Weil-McLain Gas.....	221-222
Weil-McLain Oil.....	223
<b>Boilers- Weil-McLain.....</b>	<b>226</b>
<b>Bolts.....</b>	<b>517</b>
<b>Bolts</b>	
Hercules® Toilet.....	177
Machine.....	517
PlumBest®.....	518
<b>Bowl Gaskets</b>	
Harvey.....	176
Zurn®.....	180
<b>Bowl Rings</b>	
Gunk® Kant-Leak®.....	178
Radiator Specialty Toilet.....	178
<b>Bowl Setting Bolts</b> Hercules®.....	<b>177</b>
<b>Bowl Setting Rings</b> Hercules®.....	<b>178</b>
<b>Brackets</b>	
Slant/Fin Element.....	273
Tube Support Warwick.....	523
<b>Brady</b>	
Directional Flow Arrow Tape.....	363
Pipe Identification.....	363
Pipe Markers.....	363
Roll Form Markers.....	363
Valve Identification.....	363
Valve Lockouts.....	364
Valve Tags.....	364
<b>Brass Fittings</b>	
Compression.....	496
Flare.....	497
Hammond Valve.....	270
Pipe Nipples.....	368
PlumBest® Hose.....	188, 506
Threaded.....	365
<b>Brass Pipe.....</b>	<b>365</b>
<b>Brass Plugs</b> Keeney Mfg Co.....	<b>159</b>
<b>Brass Tubular</b>	
Keeney Mfg Co.....	159
McGuire Products.....	159-160
<b>Brass Valves</b>	
Hammond Hose End.....	359
Hammond Stop & Waste .....	359
Raven Boiler.....	359
Strataflo Foot.....	360
<b>BrassCraft®</b>	
Appliance Connectors.....	182
Closet Risers.....	157
Closet Supply Kits.....	156
Faucet Supply Kits.....	156
Integral Shut-Off Stops.....	156
Lavatory/Sink Risers.....	156

Needle Valves.....	157
Nosepieces.....	157
Stop Components.....	156
Stop Valves.....	155
Water Ball Stop Valves .....	155
<b>Brazing Products</b> TurboTorch.....	<b>597</b>
<b>Brazing Rods</b> Lenox.....	<b>597</b>
<b>Brenelle "Jet Swet"™ Solder.....</b>	<b>598</b>
<b>Bronze Valves</b>	
A Y McDonald Gas Stop.....	358
A Y McDonald Radiator.....	358
Apollo Ball.....	297
Check.....	318
Gate.....	311
Globe.....	315
Lunkenheimer Blow-Off.....	354
United Boiler.....	353
<b>Brushes</b>	
Applicator.....	547, 599
Boiler.....	547
Fitting.....	546
Flue.....	547
Mill-Rose Four-In-One.....	547
Mill-Rose Maintenance.....	546
Mill-Rose Power Hex Shank.....	546
PlumBest®.....	547
<b>Bulb Wells</b> Powers.....	<b>288</b>
<b>Bulbs</b> Wal-Rich Corporation Rough Service.....	<b>531</b>
<b>Bulkhead Fittings</b> PVC Schedule 80.....	<b>412</b>
<b>Butterfly Valves</b>	
Centerline.....	349
Flowseal Steel.....	350
Nibco.....	350

### C

<b>C-Clamps.....</b>	<b>519</b>
<b>Cabinets</b> Tyco Fire & Building Sprinkler Head.....	<b>186</b>
<b>Cable</b>	
General Wire Spring Co Flexicore.....	528
General Wire Spring Co Replacement .....	528
Raychem Heating.....	516
<b>Cable Connectors</b> General Wire Spring Co.....	<b>528</b>
<b>Cable Cutters</b> General Wire Spring Co.....	<b>528</b>
<b>Cable Hangers</b>	
Caddy®.....	524
Erico®.....	524
<b>Cable Ties</b> Nylon.....	<b>538</b>
<b>Caddy®</b>	
Cable Hangers.....	524
Conduit Supports.....	524
Cushion Clamps.....	524
Pipe Hangers.....	524
Split Ring Hangers.....	525
Strut Nuts.....	524
Strut Supports.....	524
<b>Cage Units</b> Barnes & Jones.....	<b>246</b>

Prices & specifications are subject to change.

Metropolitan Pipe offers FREE DELIVERY in the Greater Boston area.



## Product Index

Index

<b>Caps</b> SpeedFill.....	252	Special Purpose Tools.....	537
<b>Carbon Steel Fittings</b>		Tongue & Groove Pliers.....	535
Black Nipples.....	460, 462-463	Wrenches.....	534
Weld.....	455	<b>Channels</b> Superstrut® Metal Framing.....	523
<b>Carlin Burners</b> .....	226	<b>Chatham Brass</b>	
<b>Carrier Trim</b> Zurn®.....	180	Shower Arms.....	171
<b>Cartridge Puller</b> Pasco Specialty Moen® Stem....	541	Shower Heads.....	72
<b>Cartridges</b> Sloan Waterfree Urinal.....	114	Silicone Sealants.....	602
<b>Cast Iron</b> Soil Pipe.....	417	<b>Check Valves</b>	
<b>Cast Iron Fittings</b>		Bronze.....	318
Black 125# Flanged.....	437	Crane Cast Steel.....	331
Black 125# Threaded.....	435	Crane Elastomer-Lined.....	347
Black 250# Flanged.....	438	Crane High Performance.....	348
Black 250# Threaded.....	437	Eclipse.....	353
Soil No-Hub.....	417	Edwards Forged Steel.....	343
Soil Service.....	420	Iron Stop.....	327
XH.....	423	Nibco Iron.....	325
<b>Cast Iron Valves</b> American Ball.....	308	Powell Cast Steel.....	332
<b>Cast Steel Valves</b>		Powell Stainless Steel.....	346
Crane Check.....	331	Rockford.....	353
Crane Gate.....	328	Spears PVC.....	309
Crane Globe.....	330	Vogt Forged Steel.....	339
Powell Check.....	332	<b>Chemique</b> Bathroom & Kitchen Cleaners.....	604
<b>Caulk</b> Hercules®.....	602	<b>Cherne Industries</b> Mechanical Pipe Plugs.....	184
<b>Caulk Gun</b> .....	602	<b>Cherne®</b>	
<b>Caulking</b> Wal-Rich Corporation.....	543	Mechanical Pipe Plugs.....	184
<b>Caulking Irons</b> Mephisto.....	544	Pneumatic Pipe Plugs.....	184
<b>Ceiling &amp; Floor Plates</b> .....	162	Seal Plugs.....	184
<b>Ceiling Hangers</b> Flanged.....	521	<b>Chicago Faucets</b>	
<b>Cement</b>		Commercial Faucets.....	23
Hercules® Boiler/Stove.....	603	Electronic Lavatory Faucet Transformers.....	51
Hercules® Plastic Pipe.....	610	Electronic Lavatory Faucets.....	48
Mix.....	545	Hydrants.....	59
<b>Cements</b> Noble Co.....	171	Laboratory Faucets.....	60
<b>Centerline</b> Butterfly Valves.....	349	Laboratory Fittings.....	62
<b>Central Brass</b>		Lavatory Faucets.....	35, 37-38, 42
Faucets.....	36	Metering Lavatory Faucets.....	45
Laundry Faucets.....	56	Pre-Rinse Faucets.....	23
Service Sink Faucets.....	56	Service Sink Faucets.....	53, 57
Tub & Shower Fittings.....	71	Showerhead Valves.....	72
<b>Cesco Brass</b> Ballcocks.....	173	Sillcocks.....	59
<b>Chain</b> Babbitt Steam Specialty Co.....	361	Turrets.....	63
<b>Chain Wrenches</b> Ridgid.....	555	Vertical Center Faucets.....	56
<b>Chainwheel Attachments</b> Babbitt Steam		<b>Chicago Specialty</b> Tank Covers.....	175
Specialty Co.....	361	<b>Chimney Relining Parts</b> ProTech.....	256
<b>Chainwheels</b> Babbitt Steam Specialty Co.....	361	<b>Chisels</b> Mephisto.....	544
<b>Chalk Line</b>		<b>Chloroloy® 240</b> Noble Shower Pan Liners.....	171
Irwin® Industrial Tools.....	539	<b>Chrome Plated Fittings</b> Pipe Nipples.....	369
PlumBest® Neon.....	539	<b>Chrome-Plated Brass Fittings</b> Compression.....	497
<b>Champion Cutting Tool Corp</b>		<b>Chucks</b> Milwaukee®.....	582
Drill Bits Set.....	583	<b>Church®</b>	
Masonry Drill Bits.....	583	Medic-Aid® Seats.....	118
<b>Channellock®</b>		Plastic Toilet Seats.....	117
Cutting Pliers.....	536	Wood Toilet Seats.....	117
Linemen's Pliers.....	536	<b>Circulator Flanges</b> Raven.....	264
Long Nose Pliers.....	536	<b>Circulator Valve Fittings</b> Hammond Valve.....	270
Nut Drivers.....	533	<b>Circulators</b>	
Screwdrivers.....	533	Bearing Assemblies.....	265
		Bell & Gossett Pumps.....	265
		Body Gaskets.....	265

Prices & specifications are subject to change.



## Product Index

Couplers.....	265	<b>Compression Fittings</b>	
Grundfos.....	258	Brass.....	496
Motors.....	265	Chrome-Plated Brass.....	497
Seal Kits.....	265	<b>Compression Nuts</b> Brass.....	496-497
Taco.....	265	<b>Conduit Clamps</b> Superstrut®.....	524
Taco Inc Cartridge.....	262	<b>Conduit Cutters</b> Ridgid.....	559
Taco Inc Red Baron.....	263	<b>Conduit Supports</b>	
<b>Clamps</b>		Caddy®.....	524
Beam.....	518	Erico®.....	524
Black "C".....	519	<b>Cone Nuts</b> Superstrut®.....	523
Caddy® Cushion.....	524	<b>Connectors</b>	
Erico® Cushion.....	524	BrassCraft® Appliance.....	182
Friction.....	520	Dormont Supr-Safe® Gas Disconnect.....	182
Ideal General Purpose Worm Gear.....	525	Flex-Hose Bronze Flexible.....	480
Skinner Emergency Pipe.....	480	Fluidmaster® Appliance.....	176
Superstrut®.....	524	Fluidmaster® Faucet.....	176
<b>Cleaners</b>		Fluidmaster® Toilet.....	175
Chemique.....	604	Fluidmaster® Water Supply.....	170
Gunk® Green Concentrated.....	604	SpeedFill.....	252
Hercules®.....	611	<b>Control Valves</b> Grohe.....	71
Hercules® Boiler/Heating System.....	600	<b>Controllers</b> Powers Accritem® Temperature.....	288
Hercules® Drain/Waste System.....	604-605	<b>Controls</b> ProRadiant.....	491
Hercules® Hand.....	604	<b>Convactor Valves</b> Vent-Rite.....	248
Silver King Mfg Boiler.....	600	<b>Copper Fittings</b>	
<b>Cleanout Plugs</b> .....	424	Bell & Gossett Monoflo.....	271
<b>Clevis Hangers</b> .....	520	ProPress.....	388
<b>Climate Panel System</b> ProRadiant.....	490	TecTite™.....	384
<b>Clips</b> Pipe.....	518	<b>Copper Grooved Piping Systems</b> Grinnell®.....	474
<b>Closet Bolt Gaskets</b> Tank.....	179	<b>Copper Straps</b> Perforated.....	518
<b>Closet Bolts</b> Brass.....	179	<b>Copper Tubing</b>	
<b>Closet Carrier Trim</b> Zurn®.....	180	Medical Gas.....	371
<b>Closet Flange Extensions</b> J-Tec Products Company.....	178	Refrigeration.....	370-371
<b>Closet Flange Spacers</b> PlumBest®.....	181	Type DWV.....	370
<b>Closet Flanges</b>		Type K.....	370
J-Tec Products Company.....	178	Type L.....	370
PVC DWV.....	406	Type M.....	370
Raven PVC DWV.....	179	<b>Copper Tubing Cutters</b> General Wire Spring Co Autocut™.....	574
<b>Closet Gaskets</b>		<b>Copper Valves</b> Nibco Stop & Waste.....	358
Harvey.....	176-177	<b>Cord</b> Wal-Rich Corporation Extension.....	531
Zurn®.....	180	<b>Coupling Nuts</b> Wal-Rich.....	162
<b>Closet Rings</b>		<b>Couplings</b>	
Pasco Specialty.....	178	Anoco No-Hub.....	425
Wal-Rich Corporation.....	180	Dresser Industries Steel.....	478
<b>Closet Risers</b> BrassCraft®.....	157	Grinnell® Grooved.....	470
<b>Closet Screws</b> Wal-Rich Corporation Brass.....	180	Gruvlok.....	481
<b>Closet Spuds</b> Wal-Rich Corporation.....	180	Handrail Fittings.....	511
<b>Closet Supply Kits</b>		No-Hub.....	424
BrassCraft®.....	156	Orion Fittings Acid Waste.....	398
McGuire Products.....	160	Wal-Rich Corporation Bathcock.....	180
<b>Combination Heaters/Water Heaters</b> Navien.....	215	Wal-Rich Corporation Bead Chain.....	172
<b>Combustion Air Systems</b> Field Controls.....	255	Wal-Rich Corporation MI Compression.....	481
<b>Commercial Boilers</b> Gas.....	228-230	<b>Coveralls</b> PlumBest® Disposable.....	551
<b>Commercial Faucets</b> Chicago Faucets.....	23	<b>CPVC</b>	
<b>Commercial Gate Valves</b> Watts Regulator Iron....	149	CTS Pipe.....	414
<b>Compressed Air Treatment</b> Watts FluidAir.....	296	Schedule 80 Fittings.....	414
<b>Compression Couplings</b> Wal-Rich Corporation MI.....	481	<b>CPVC Fittings</b> Nipples Sch 80.....	413
		<b>CPVC Valves</b> Spears Ball.....	310

Prices & specifications are subject to change.

Metropolitan Pipe offers Vendor Managed Inventory - never run out of that part again!



## Product Index

Index

<b>Crane</b>	
Cast Steel Check Valves.....	331
Cast Steel Gate Valves.....	328
Cast Steel Globe Valves.....	330
Elastomer-Lined Check Valves.....	347
High Performance Check Valves.....	348
Instrumentation Valves.....	356
Iron Globe Valves.....	324
<b>Crimpers</b>	
Channellock®.....	537
Midwest Snips.....	538
Ridgid Pressing.....	395, 575
<b>Crosses</b> Handrail Fittings.....	510
<b>Cushion Clamps</b>	
Caddy®.....	524
Erico®.....	524
<b>Cut-Off Machine Wheels</b> Milwaukee®.....	582
<b>Cut-Off Machines</b> Milwaukee®.....	582
<b>Cutter Blades</b> Ridgid.....	560
<b>Cutter Wheels</b>	
Lenox.....	574
Ridgid Pipe.....	562
Ridgid Tubing.....	560
<b>Cutters</b>	
Channellock® Pliers.....	536
General Wire Spring Co Cable.....	528
Lenox Tubing.....	574
Mill-Rose Pipe.....	574
Raven Inside Pipe Cutters.....	542
Ridgid Pipe.....	561
Ridgid Tubing.....	558
Wal-Rich Corporation Glass.....	574
Wheeler Rex Glass.....	574
<b>Cutting Oil</b> Ridgid.....	572

### D

<b>Danfoss</b> Radiator Valves & Accessories.....	295
<b>Daubers</b> Hercules®.....	610
<b>Deburring Tools</b> Ridgid.....	564
<b>Delta</b>	
Kitchen Faucets.....	28-29
Lavatory Faucets.....	37-38, 40
Metering Lavatory Faucets.....	47
<b>Descalers</b> Whitlam.....	601
<b>Detectors</b> Mannix.....	548
<b>Dewatering Pumps</b> Zoeller.....	196
<b>DHW/Boiler Controls</b> tekmar® Controls.....	236
<b>Dial Thermometer</b> Leonard Valve.....	136
<b>Die Heads</b> Ridgid.....	568
<b>Dies</b>	
Ridgid Carrying Case.....	569
Ridgid Pipe.....	568
<b>Directional Flow Arrow Tape</b> Brady.....	363
<b>Dishwashers Connectors</b> Fluidmaster®.....	176
<b>Dispensers</b> InSinkErator® Hot Water.....	33

<b>Disposable Coveralls</b> PlumBest®.....	551
<b>Disposers</b>	
Commercial InSinkErator.....	128
InSinkErator Garbage.....	128
<b>Dixon</b> Fire Hose Fittings.....	186
<b>Dole Controls</b>	
Air Valves.....	248
Parts & Accessories.....	248
<b>Dormont</b> Supr-Safe® Gas Quik Disconnects.....	182
<b>Douglas®</b>	
Aluminum Levels.....	531
Slip-Joint Pliers.....	537
Tools.....	542
<b>Dragon</b> Instrumentation Valves.....	355
<b>Drain Bodies</b> PlumBest®.....	169
<b>Drain Cleaners</b>	
Gunk® Toilet Plungers.....	542
Hercules®.....	604-605
PlumBest.....	605
<b>Drain Cleaning</b>	
General Wire Spring Co D-25 Handy.....	529
General Wire Spring Co Kinetic Water Ram ..	528
General Wire Spring Co Mini-Rooter.....	527
General Wire Spring Co Mini-Rooter XP.....	527
General Wire Spring Co Power-Vee.....	527
General Wire Spring Co Speedrooter 91.....	527
General Wire Spring Co Super-Vee.....	527
<b>Drain Covers</b> Cast Iron.....	168
<b>Drain Flushers</b> Peterson Products Co.....	541
<b>Drain Hose</b> Wal-Rich Corporation Sump Pump....	199
<b>Drain Jets</b> Peterson Products Co.....	541
<b>Drain Openers</b> JC Whitlam Green Blaster.....	606
<b>Drain Plugs</b>	
PlumBest®.....	172
Radiator Specialty.....	172
<b>Drain Removal Tools</b> PlumBest® Tub.....	540
<b>Drain Stoppers</b> PPP Manufacturing Co.....	172
<b>Drains</b>	
Cleanout Plugs.....	424
Commercial Kitchen.....	166
Floor.....	167
Gerber Brass Pop-Up.....	169
Gerber Brass Trip.....	169
Gerber Trim Kits.....	169
Lavatory.....	166
Plug & Grid.....	166
PlumBest® Cleanout Spuds.....	170
Shower.....	167
Specialty Sink.....	167
<b>Drench Hose Units</b> Guardian Equipment.....	132
<b>Dresser Industries</b> Steel Couplings.....	478
<b>Drill Bits</b>	
Champion Cutting Tool Corp.....	583
Champion Cutting Tool Corp Masonry.....	583
Irwin® Industrial Tools Hammer.....	585
Irwin® Industrial Tools Metal Twist.....	585
Irwin® Industrial Tools Spade.....	586
Irwin® Industrial Tools Woodboring.....	585
Lenox Kits.....	586

Prices & specifications are subject to change.





## Product Index

Lenox Vari-Bit®.....	586
Sammy Super Screw™.....	526
<b>Drill Chucks Milwaukee®.....</b>	<b>582</b>
<b>Drinking Faucets.....</b>	<b>13</b>
<b>Drive Screws.....</b>	<b>522</b>
<b>Drive Sets Irwin® Industrial Tools.....</b>	<b>584</b>
<b>Drum Traps PVC DWV.....</b>	<b>406</b>
<b>Dry Boxes Mill-Rose.....</b>	<b>553</b>
<b>Dryer Vents Lambro Industries Kits.....</b>	<b>255</b>
<b>Ducting Lambro Industries Aluminum.....</b>	<b>255</b>
<b>Duraguard™ Wall Guards EL Mustee.....</b>	<b>97</b>
<b>Duriron Mechanical Joint Couplings Flowserve.....</b>	<b>400</b>
<b>Dust Masks PlumBest®.....</b>	<b>551</b>
<b>DWV Fittings PVC.....</b>	<b>403</b>
<b>DWV Tubing Copper.....</b>	<b>370</b>

### E

<b>Edwards</b>	
Forged Steel Check Valves.....	343
Forged Steel Globe Valves.....	338
Steel Blow-Off Valves.....	354
<b>Eemax Water Heaters.....</b>	<b>200</b>
<b>Effluent Pumps Little Giant.....</b>	<b>196</b>
<b>EL Mustee</b>	
Laundry Tubs.....	96
Mop Basin Accessories.....	97
Mop Basins.....	97
Wall Guards.....	97
<b>Elbows.....</b>	<b>158</b>
<b>Elbows Handrail Fittings.....</b>	<b>509</b>
<b>Electrical Tape.....</b>	<b>553</b>
<b>Electrical Tools Multimeters.....</b>	<b>547</b>
<b>Electronic Lavatory Faucet Transformers</b>	
Chicago Faucets.....	51
<b>Electronic Lavatory Faucets Chicago Faucets....</b>	<b>48</b>
<b>Electronic Low Water Cutoffs McDonnell &amp; Miller</b>	<b>239</b>
<b>Elements Slant/Fin.....</b>	<b>273</b>
<b>Elias Industries Water Closet Accessories.....</b>	<b>173</b>
<b>Elkay</b>	
Hospitality/Bar Faucets.....	30
Kingsford® Stainless Steel Kitchen Sinks.....	127
Kitchen Faucets.....	30
Stainless Steel Sinks.....	125, 127
<b>Emergency Eyewashes Guardian Equipment.....</b>	<b>132</b>
<b>Emergency Mixing Valves Leonard Valve.....</b>	<b>51, 134</b>
<b>Emergency Showers Guardian Equipment.....</b>	<b>133</b>
<b>Epoxy Hercules®.....</b>	<b>599</b>
<b>Erico®</b>	
Cable Hangers.....	524
Conduit Supports.....	524
Cushion Clamps.....	524
Pipe Hangers.....	524
Split Ring Hangers.....	525
Strut Nuts.....	524

Strut Supports.....	524
<b>Escutcheons</b>	
Floor & Ceiling.....	162
PlumBest®.....	161
Wal-Rich.....	162
<b>Everlasting Iron Boiler Drain Valves.....</b>	<b>353</b>
<b>Expansion Compensators</b>	
Flex-Hose Co.....	480
Hydro-Flex.....	480
<b>Expansion Couplings Slant/Fin.....</b>	<b>274</b>
<b>Expansion Tanks Watts.....</b>	<b>219</b>
<b>Extension Cords Wal-Rich Corporation.....</b>	<b>531</b>
<b>Extensions.....</b>	<b>158</b>
<b>Extensions Slip Joint.....</b>	<b>157</b>
<b>Extractors Wal-Rich Corporation Screw.....</b>	<b>543</b>
<b>Eye Washes Guardian Equipment.....</b>	<b>132</b>

### F

<b>FasNSeal® Protech Venting Systems.....</b>	<b>256</b>
<b>Fastener Drive Sets Irwin® Industrial Tools.....</b>	<b>584</b>
<b>Fasteners</b>	
Johns-Manville.....	515
ProRadiant.....	487
PureFlow.....	487
<b>Faucet Connectors Fluidmaster®.....</b>	<b>176</b>
<b>Faucet Risers BrassCraft®.....</b>	<b>156</b>
<b>Faucet Screws Gunk®.....</b>	<b>163</b>
<b>Faucet Spouts T&amp;S Brass.....</b>	<b>27</b>
<b>Faucet Supply Kits BrassCraft®.....</b>	<b>156</b>
<b>Faucet Washers Gunk®.....</b>	<b>163</b>
<b>Faucets</b>	
Central Brass.....	36
Chicago Faucets Laboratory.....	60
Chicago Faucets Service Sink.....	53, 57
Chicago Faucets Showerhead Valves.....	72
Delta Kitchen.....	28-29
Elkay Hospitality/Bar.....	30
Gerber Bar.....	31
Gerber Kitchen.....	31
Gerber Laundry.....	57
Gerber Lavatory.....	40
Grohe Kitchen.....	31
Kitchen Faucets.....	20-22
Kohler Kitchen.....	32-33
Kohler Sink Commercial.....	52
Speakman® Sink.....	52
Tub & Shower Faucets.....	71
Vertical Centers.....	56
<b>Fender Washers.....</b>	<b>522</b>
<b>Fiberglass Showers Aquatic.....</b>	<b>123</b>
<b>Fiberglass Tub &amp; Shower Units Aquatic.....</b>	<b>124</b>
<b>Fiberglass Tub &amp; Showers Aquatic.....</b>	<b>123</b>
<b>Field Controls Combustion Air Systems.....</b>	<b>255</b>
<b>Files PlumBest®.....</b>	<b>538</b>

Prices & specifications are subject to change.

Our faucet parts counter is one of the largest in the Boston area with thousands of parts in stock!



## Product Index

Index

<b>Fill Valves</b> Fluidmaster®.....	173
<b>Filters</b> Watts FluidAir Compressed Air .....	296
<b>Fire Hose Fittings</b> Dixon.....	186
<b>Fire Prevention Valves</b> Nibco.....	352
<b>Fire Protection</b> Grinnell® Grooved.....	187
<b>Fire Retardants</b> Mill-Rose.....	598
<b>Fire Safety Valves</b> SpeedFill.....	253
<b>Fire Sprinklers</b> Tyco Fire & Building.....	186
<b>Firestopping Products</b> Rectorseal®.....	602
<b>Firomatic</b> Thermal Switches.....	254
<b>Fish Plate</b> Washers.....	522
<b>Fitting Brushes</b>	
Mill-Rose.....	546
Mill-Rose Power Hex Shank.....	546
<b>Fitting Covers</b> Johns-Manville Zeston.....	514
<b>Fittings</b>	
304 Stainless Steel 150# Threaded .....	465-466
316 Stainless Steel 150# Threaded .....	466-467
Angle.....	519
AY McDonald.....	481
Bell & Gossett Monoflo .....	271
Black Cast Iron 125# Flanged.....	437
Black Steel Nipples.....	460, 462-463
Brass Compression.....	496-497
Brass Flare.....	497-498
Brass Garden Hose.....	188, 506
Brass Pipe Nipples.....	368
Brass Threaded.....	365-367
Bronze.....	385, 387
Cast Iron Black 125# Flanged.....	437-438
Cast Iron Black 125# Threaded .....	435-437
Cast Iron Black 250# Flanged.....	438
Cast Iron Black 250# Threaded.....	437
Cast Iron Galvanized 125# Flanged.....	446
Cast Iron Galvanized 125# Threaded.....	445
Cast Iron NH Soil.....	417-420
Cast Iron Soil No-Hub.....	417
Cast Iron Soil Service.....	420-423
Cast Iron Soil Specialty.....	423
Chrome Plated Nipples.....	369
Chrome-Plated Brass Compression .....	497
Compression Tube.....	498
Copper.....	371-378
Copper DWV.....	378-380
Copper Washed.....	380
CPVC.....	416
CPVC Sch 80 Nipples.....	413
CPVC Schedule 80.....	414-415
Dielectric.....	447
Dixon Fire Hose.....	186
Dresser Industries Couplings.....	478
FlowGuard Gold.....	415
Forged Steel.....	447-448
Fusion.....	426
Galvanized Steel Nipples.....	463
Grinnell® Grooved.....	471
Grinnell® Grooved Fire Protection.....	187
Hammond Valve.....	270
Iron Black Malleable 150# Threaded .....	438-442, 444
Iron Black Malleable 250# Threaded.....	444
Iron Black Malleable 300# Threaded.....	438, 442-444

Iron Galvanized Malleable 150# Threaded.....	444-447
Orion Fittings Acid Waste .....	398
PlumBest® Brass Hose .....	188, 506
PlumBest® Brass Hose Barb .....	189, 506
PlumBest® Nylon.....	505
ProPress.....	385, 387-388, 390, 392
ProRadiant.....	485
PureFlow.....	485
PVC DWV.....	403-406
PVC Sch 80 Nipples.....	413
PVC Schedule 40.....	406
PVC Schedule 80.....	409-412
Schedule 40.....	406-408
Schedule 80.....	409-411
Smoke Pipe.....	257
Speedfit Polyethylene.....	503
Speedfit Twist & Lock.....	502
Stainless Steel Pipe Nipples .....	468
Steel Carbon Weld.....	455-458
Steel Forged 2000#.....	455
Steel Forged 3000#.....	452-455
Steel XH Carbon Weld.....	458-459
TecTite™ Copper.....	384
XH Cast Iron.....	423

<b>Flame Safeguard</b> Honeywell Pressure & Limit Controls.....	283
---	-----

### Flanges

Bell & Gossett.....	266
Cast Iron Galvanized 125# Flanged.....	446
Copper.....	375
CPVC Schedule 80.....	415
CPVC Van Stone.....	415
Handrail Fittings.....	507
Iron Black Malleable 150# Threaded.....	438
Iron Black Malleable 300# Threaded.....	438
Iron Galvanized Malleable 150# Threaded.....	446
J-Tec Closet.....	178
Keeney Mfg Co Shower Rod.....	171
McGuire Products.....	160
Phoenix Forge Steel Tank.....	252
Raven PVC DWV Closet.....	179
Steel Forged 150#.....	448-450
Steel Forged 1500#.....	452
Steel Forged 300#.....	450-451
Steel Forged 3000#.....	452
Steel Forged 600#.....	451
Taco Inc Freedom.....	264
Zurn®.....	162

### Flappers

Korky® Toilet.....	174
Seal-O-Matic® Toilet.....	174
Sealmaster® Toilet.....	174

<b>Flare Fittings</b> Brass.....	497
----------------------------------	-----

<b>Flaring Tools</b> Ridgid.....	565-566
----------------------------------	---------

<b>Flashing</b> Oatey.....	185
----------------------------	-----

<b>Flashing Sealants</b> Hercules®.....	602
---	-----

<b>Flashlights</b> .....	551
--------------------------	-----

<b>Flashlights</b> Maglite.....	551
---------------------------------	-----

### Flex Connectors

BrassCraft® Appliance.....	182
Dormont Supr-Safe® App.....	182

Prices & specifications are subject to change.



## Product Index

Fluidmaster® Appliance.....	176
Fluidmaster® Faucet.....	176
Fluidmaster® Ice Maker.....	170
Fluidmaster® Toilet.....	175
<b>Flex Duct</b> Lambro Industries.....	255
<b>Flex Supplies</b> McGuire Products.....	159
<b>Flex-Hose Co.</b>	
Expansion Compensators.....	480
Flex Connectors.....	480
<b>Flexible Connectors</b> Flex-Hose Bronze.....	480
<b>Flexitallic</b> Spiral Wound Gaskets.....	513
<b>Flippen Float Valves</b> Watts.....	153
<b>Flo-Chek Valves</b> Taco Inc.....	269
<b>Float &amp; Thermostatic Traps</b> Hoffman Specialty...	247
<b>Float Ball</b> Wal-Rich Corporation Plastic.....	179
<b>Float Valves</b>	
Barnes & Jones.....	246
Watts Flippen.....	153
<b>Floats</b> Watts Drainage Copper.....	154
<b>Flocontrol Valves</b> Tasco.....	356
<b>Floodmaster</b> Leak Detection.....	219-220
<b>Floor &amp; Ceiling Plates</b> .....	162
<b>Floor Sucker Pump</b> Zoeller.....	192
<b>Flow Valves</b> Bell & Gossett.....	270
<b>FlowGuard Gold</b> Fittings.....	415
<b>Flowseal</b> Steel Butterfly Valves.....	350
<b>Flowserve Duriron</b> Mechanical Joint Couplings...	400
<b>Flue Brushes</b> Mill-Rose.....	547
<b>Fluidmaster®</b>	
Appliance Flex Connectors.....	176
Ballcocks.....	174
Faucet Flex Connectors.....	176
Flappers.....	174
Flush Valves.....	174
Toilet Flex Connectors.....	175
Toilet Parts.....	173-174
Toilet Tank Levers.....	175
<b>Flush Valve Parts</b> Shank Washers.....	179
<b>Flush Valves</b>	
Cesco Brass Douglas.....	173
Fluidmaster®.....	174
Sloan.....	77, 79
Sloan Bed Pan Cleaners.....	83
Sloan Conversion Kits.....	79
<b>Flushometers</b>	
Sloan Valve.....	82
Solar Powered Sensor.....	82
Touchless.....	83
<b>Flux</b>	
Mill-Rose.....	613
Rectorseal®.....	613
<b>Foot Valves</b> Strataflo Brass.....	360
<b>Force Cups</b> Gunk®.....	542
<b>Forged Steel Fittings</b> .....	448
<b>Forged Steel Fittings</b>	
Flanges 150#.....	448
Flanges 1500#.....	452

Flanges 300#.....	450
Flanges 3000#.....	452
Flanges 600#.....	451
<b>Forged Steel Valves</b>	
Edwards Check.....	343
Edwards Globe.....	338
Vogt Check.....	339
Vogt Gate.....	334
Vogt Globe.....	336
<b>Four-In-One Brushes</b> Mill-Rose.....	547
<b>Framing</b> Superstrut®.....	523
<b>Freedom Flanges</b> Taco Inc.....	264
<b>Friction Clamps</b> .....	520
<b>Friction Rings</b>	
Gunk® Brass.....	163
Wal-Rich Corporation.....	180
<b>Frostex® Heating Cable</b> Raychem.....	516
<b>Furnace Cement</b> Hercules®.....	603
<b>Fusion Bond Pipe</b> Steel.....	434
<b>Fusion Piping</b>	
Saddle Sockets.....	432
Tools.....	431

### G

<b>Galv Steel Fittings</b> Standard Nipples.....	463
<b>Galvanized Malleable Iron</b> Fittings 150#	
Threaded.....	444
<b>Galvanized Pipe</b> Steel.....	434
<b>Galvanizing Spray</b> Rectorseal® Cold.....	612
<b>Garbage Disposers</b>	
InSinkErator.....	128
InSinkErator Commercial.....	128
<b>Garden Hose</b> PlumBest®.....	189
<b>Garden Hose Nozzle</b> Wal-Rich Corporation.....	189
<b>Gas Appliance Connectors</b>	
BrassCraft® Corrugated SS Coated.....	182
Dormont Supr-Safe® Corrugated SS Coated.....	182
<b>Gas Boilers</b> Weil-McLain.....	221-222
<b>Gas Detectors</b> Mannix.....	548
<b>Gas Fittings</b> FlashShield.....	495
<b>Gas Stop Valves</b> A Y McDonald Bronze.....	358
<b>Gas Testers</b> Rogers.....	548
<b>Gas Tubing</b>	
Copper Medical.....	371
FlashShield.....	495
<b>Gas Valves</b> Honeywell.....	286
<b>Gas Vent Signs</b> Raven Warning/Identification.....	255
<b>Gas Venting</b>	
Armstrong®.....	248
Field Controls Combustion Air System.....	255
<b>Gaskets</b>	
Anaco.....	425
Armstrong® International Steam Trap.....	244
Bell & Gossett.....	267

Prices & specifications are subject to change.

Our office hours are 7am to 4:30pm and counter hours 6am to 4:30pm Monday through Friday.



## Product Index

Index

Closet Tank.....	179
Flexitallic Spiral Wound.....	513
Grinnell®.....	476
Gunk® Mack Basin Sink & Bath.....	164
Harvey No-Wax for Zurn.....	177
Harvey Wax Closet.....	176
Hercules® Toilet Bowl Setting.....	178
McDonnell & Miller.....	241
Non Asbestos.....	512
Radiator Specialty Toilet.....	178
Red Rubber.....	512
Service-Weight.....	425
Zurn® Toilet Bowl Setting.....	180
<b>Gasola</b> Pipe Seal.....	610
<b>Gasola®</b> Penetrating Oils.....	607
<b>Gate Valves</b>	
Bronze.....	311
Crane Cast Steel.....	328
Nibco Iron.....	323
Powell Stainless Steel.....	344
Vogt Forged Steel.....	334
Watts Regulator Commercial Iron.....	150
Watts Regulator Iron Commercial.....	149
<b>Gauge Adapters</b> Watts Regulator.....	153
<b>Gauge Glass Cutters</b> Wal-Rich Corporation.....	574
<b>Gauges</b>	
Miljoco Pressure.....	278
SpeedFill.....	254
TurboTorch.....	596
Wal-Rich Corporation.....	282
<b>General Wire Spring Co</b>	
Augers Closet.....	529
Augers Urinal.....	529
Cable Connectors.....	528
Cable Cutters.....	528
D-25 Handy Drain Cleaning.....	529
Drain Cleaning Mini-Rooter XP.....	527
Flexicore Cable.....	528
Flexicore Wire Rope Center Augers.....	529
Kinetic Water Ram Drain Cleaning.....	528
Mini-Rooter Drain Cleaning.....	527
Pipe Maintenance Cold Shot™ Pipe Freeze..	579
Pipe Maintenance Hot Shot™ Pipe Thawing..	579
Power-Vee Drain Cleaning.....	527
Replacement Cable.....	528
Speedroooter 91 Drain Cleaning.....	527
Super-Vee Drain Cleaning.....	527
Tubing Cutter Autocut™.....	574
Tubing Cutters SuperSlice™ Plastic.....	574
<b>Generators</b> Honeywell Power.....	284
<b>Gerber</b>	
Bar Faucets.....	31
Drain Trim Kits.....	169
Drains.....	169
Kitchen Faucets.....	31
Laundry Faucets.....	57
Lavatory Faucets.....	40
<b>Glass Cutters</b> Wheeler Rex.....	574
<b>Glass Fillers</b> T&S Brass.....	26
<b>Globe Valves</b>	
Bronze.....	315
Crane Cast Steel.....	330
Crane Iron.....	324
Edwards Forged Steel.....	338
Vogt Forged Steel.....	336
Vogt Valve.....	345
Vogt Valve Forged.....	343
<b>Gloves</b>	
Irwin® Industrial Tools.....	550
Leather Work.....	550
PlumBest®.....	550
<b>Goss®</b> Trigger Torch.....	594
<b>Grab Bars</b> Concealed with SGO.....	172
<b>Granby</b> Residential Oil Tanks.....	252
<b>Graphite Packing Spools</b> Wal-Rich Corporation Non-Asbestos.....	543
<b>Grease</b> Gunk® Plumber's Heat-Pruf.....	607
<b>Grease Interceptors</b> Watts.....	131
<b>Grinder Wheels</b> Milwaukee®.....	582
<b>Grinding Systems</b> Saniflo.....	114
<b>Grinnell®</b>	
Copper Grooved Piping Systems.....	474
Gaskets.....	476
Grooved Accessories.....	474
Grooved Couplings.....	470
Grooved Fire Protection Fittings.....	187
Grooved Fittings.....	471
Grooved Valves.....	474
Mechanical Tees.....	473
<b>Grohe</b>	
Control Valves.....	71
Kitchen Faucets.....	31
Lavatory Faucets.....	44
Single Hole Faucets.....	35
Tub & Shower Systems.....	69-70
<b>Grooved Couplings</b> Grinnell®.....	470
<b>Grooved Fire Protection Fittings</b> Grinnell®.....	187
<b>Grooved Fire Protection Piping Systems</b> Grinnell®.....	187
<b>Grooved Fittings</b> Grinnell®.....	471
<b>Grooved Piping Systems</b> Grinnell®.....	470
<b>Grooved Valves</b> Grinnell®.....	474
<b>Groovers</b> Ridgid.....	573
<b>Grooving Tools</b> Orion Fittings.....	401
<b>Grundfos</b>	
Circulator Accessories.....	261
Circulators.....	258
<b>Gruvlok</b> Couplings.....	481
<b>Guardian Equipment</b>	
Drench Hose Units.....	132
Emergency Showers.....	133
Eye Washes.....	132
Safety Shower & Eye Wash.....	133
Safety Stations.....	133
<b>Gunk®</b>	
Boiler Seal.....	601
Brass Friction Rings.....	163
Faucet Screws.....	163
Faucet Washers.....	163
Green Concentrated Cleaner.....	604

Prices & specifications are subject to change.

Metropolitan Pipe offers FREE DELIVERY in the Greater Boston area.



## Product Index

Kant-Leak® Toilet Bowl Rings.....	178
Lubricating Products.....	607
Mack Basin Sink & Bath Gaskets .....	164
O-Rings.....	163
Slip-Joint Washers.....	163
Toilet Plungers.....	542

### H

<b>Hacksaw Blades</b> Lenox.....	588
<b>Hacksaw Frames</b> Lenox.....	587
<b>Halsey Taylor</b>	
Water Chillers.....	12
Water Coolers.....	11-12
Water Fountains.....	11
<b>Hammer Drill Bits</b> Irwin® Industrial Tools.....	585
<b>Hammers</b> Ridgid.....	531
<b>Hammond</b>	
Brass Hose End Valves.....	359
Brass Stop & Waste Valves .....	359
<b>Hammond Valve</b> Circulator Valve Fittings.....	270
<b>Hand Cleaners</b> Hercules®.....	604
<b>Hand Saws</b> Lenox.....	588
<b>Hand Shower Holders</b> Hansgrohe.....	73
<b>Hand Showers</b>	
Alsons.....	74
Hansgrohe.....	73
<b>Handles</b>	
Wal-Rich Corporation Grip-Tite.....	543
Wal-Rich Corporation Radiator.....	543
<b>Handrail Fittings</b>	
Couplings.....	511
Crosses.....	510
Elbows.....	509
Flanges.....	507
Rackmaster.....	511
Swivels.....	511
Tees.....	508
<b>Hangers</b>	
Band.....	520
Caddy® Cable.....	524
Caddy® Split Ring.....	525
Clevis.....	520
Erico® Cable.....	524
Erico® Split Ring.....	525
Flange Ceiling & Wood Beam .....	521
Natick Warwick.....	523
PVC Warwick.....	523
Reznor Hooks.....	522
Riser Clamps.....	520
Side Beam.....	519
Slant/Fin Element.....	273
Split Ring.....	519
Swivel Ring.....	519
Van.....	522
<b>Hansgrohe</b>	
Hand Shower Holders.....	73
Hand Showers.....	73

Shower Heads.....	73
Tub Fillers.....	74
<b>Hartell Pumps</b>	
Laundry Pump Switches.....	199
Laundry Pumps.....	199
<b>Harvey</b>	
No-Way Gaskets for Zurn.....	177
Wax Gaskets.....	176
<b>Heat Barrier Spray</b> La-Co.....	613
<b>Heat Shields</b> Mill-Rose.....	598
<b>Heat Tape</b> Raychem.....	516
<b>Heat-Timer</b> Radiator Valves.....	248
<b>Heating</b>	
Beacon-Morris® Twin-Flo III® Heater.....	276
Modine Unit Heaters.....	277
Tankless Heaters.....	235
<b>Heating Cable</b> Raychem.....	516
<b>Heating Condensate Pumps</b> Hoffman Specialty Watchman®.....	242
<b>Hercules®</b>	
Anti-Freeze.....	600
Asphalt Paint.....	612
Boiler/Heating System Cleaners .....	600
Boiler/Heating System Stop-Leaks .....	601
Boiler/Stove Cement.....	603
Bowl Setting Bolts.....	177
Bowl Setting Rings.....	178
Brushes.....	610
Caulk.....	602
Daubers.....	610
Drain and Waste System Cleaners .....	604-605
Epoxy.....	599
Furnace Cement.....	603
Hand Cleaners.....	604
Lubricants.....	607
Pipe Tape.....	608-609
Putty.....	603
PVC Cement.....	610
PVC Primers.....	611
Roof and Flashing Sealants.....	602
Sealants.....	602
Stove Cement.....	603
Test Kits.....	600
Thread Sealants.....	608-609
<b>Hex Key Wrenches</b> PlumBest®.....	534
<b>Hex Keys</b>	
Milwaukee®.....	582
Wal-Rich Corporation T-Handle Set.....	534
<b>Hex Nuts</b> .....	517
<b>Hex Plugs</b> Steel Countersunk.....	453
<b>Hex Wrenches</b> Ridgid.....	556
<b>High Temperature Pumps</b> Zoeller.....	196
<b>Hoffman Specialty</b>	
Boiler Feed Units.....	242
Condensate Pumps.....	242
Main Steam Vents.....	249
Main Water Vents.....	249
Parts.....	242
Roberts Boiler Make-up Vavles.....	242
Special Steam Vents.....	249

Prices & specifications are subject to change.

You can check stock availability, pricing and place orders online at [www.MetPipe.com](http://www.MetPipe.com).



## Product Index

Index

Steam Traps.....	247
Supply Valves.....	296
Vacuum Breakers.....	248
<b>Hole Saw Arbors</b> Lenox.....	590
<b>Hole Saws</b> Lenox.....	589
<b>Homestead</b>	
Lubricant Sticks.....	351
Plug Valve Wrenches.....	351
Steel Plug Valves.....	351
<b>Honeywell</b>	
Aquastats®.....	285
Gas Valves.....	286
Hydronic Switching Relays.....	284
Ignition Controllers.....	286
Mixing Valves.....	294
Non-Programmable Thermostat.....	283
Oil Primary Controls.....	285
Power Generators.....	284
Pressuretrol® Controllers.....	283
Remote Temperature Controls.....	284
Thermocouples.....	284
Thermostatic Radiator Valves.....	291
Thermostatic Valve Actuators.....	292
Thermostats.....	283
Transformers.....	286
Well Assemblies.....	286
Zone Valves.....	287
<b>Hose PlumBest® Garden</b> .....	189
<b>Hose Assembly Kit</b> Watts Regulator.....	149
<b>Hose Barbs</b> PlumBest® Brass.....	189, 506
<b>Hose Clamps</b> Ideal.....	525
<b>Hose End Valves</b> Hammond Brass.....	359
<b>Hose Fittings</b>	
Dixon Fire.....	186
PlumBest® Brass.....	188, 506
Wal-Rich Corporation Garden.....	170
<b>Hose Nozzle</b> Wal-Rich Corporation Pistol Grip.....	189
<b>Hose Stations</b> Wall-Mounted.....	189
<b>Hose Washers</b> Wal-Rich Corporation.....	189
<b>Hospitality Faucets</b> Elkay.....	30
<b>Hot Water Dispensers</b> InSinkErator®.....	33
<b>HVAC Tools</b> Screwdrivers.....	532
<b>Hydrant Key</b> Zurn®.....	186, 541
<b>Hydrants</b> Chicago Faucets.....	59
<b>Hydro-Flex</b> Expansion Compensators.....	480
<b>Hydronic Controls</b> Honeywell Aquastats®.....	285
<b>Hydronic Heating</b> Weil-McLain.....	221
<b>Hydronic Products</b> Raven.....	255
<b>Hydronic Switching Relays</b> Honeywell.....	284
<b>Hydronic Valves</b> Watts Regulator.....	152

I

<b>Ice Maker Connectors</b> Fluidmaster®.....	170
<b>Ice Maker Supply Kits</b> Oatey Pex.....	170

<b>Ideal</b> General Purpose Worm Gear Clamps.....	525
<b>Impellers</b> Bell & Gossett.....	267
<b>Indirect Water Heaters</b> Lochinvar.....	212
<b>Infrared Thermometers</b> Mannix.....	547
<b>Ignition Controllers</b> Honeywell.....	286
<b>Insert Bits</b> Irwin® Industrial Tools.....	584
<b>Insert Nuts</b> .....	521
<b>Inside Pipe Cutters</b> Raven.....	542
<b>InSinkErator</b>	
Badger Garbage Disposers.....	128
Evolution Series Garbage Disposers.....	128
Garbage Disposers.....	128
Parts & Accessories.....	129
<b>InSinkErator®</b> Hot Water Dispensers.....	33
<b>Inspection Mirrors</b> Mannix.....	548
<b>Instrumentation Valves</b>	
Apollo.....	355
Crane.....	356
Dragon.....	355
Tasco.....	356
Vogt.....	357
<b>Instruments</b> Wal-Rich Corporation.....	282
<b>Insulation</b>	
Fiberglass Pipe.....	514
Rubatex Pipe.....	514
<b>Insulation Shields</b> Pipe.....	521
<b>Interceptors</b> Watts Drainage.....	131
<b>Internal Tubing Cutters</b> Ridgid.....	559
<b>Internal Wrenches</b> Ridgid.....	556
<b>Inverted Bucket Steam Traps</b> Armstrong®.....	243, 245
<b>Iron Valves</b>	
Crane Globe.....	324
Everlasting Boiler Drain.....	353
Nibco Check.....	325
Nibco Gate.....	323
<b>Irwin® Industrial Tools</b>	
Chalk Line.....	539
Fastener Drive Sets.....	584
Groovelock Pliers.....	537
Hammer Drill Bits.....	585
Insert Bits.....	584
Kneepads.....	550
Locking Pliers.....	537
Magnetic Insert Bit Holders.....	584
Marking Tools.....	539
Metal Twist Drill Bits.....	585
Nutsetters.....	584
Power Bits.....	584
Sharpie Markers.....	539
Spade Bits.....	586
Tool Bags.....	552
Woodboring Drill Bits.....	585
Work Gloves.....	550
Wrenches.....	535
<b>Isolation Flanges</b> Raven.....	264

Prices & specifications are subject to change.



## Product Index

### J

<b>J-Tec Products Company</b>	
Closet Flange.....	178
Closet Flange Extensions.....	178
<b>JC Whitlam</b>	
Anti-seize Compound.....	607
Drain Openers.....	606
Pipe Compounds.....	610
Reach Lube Oil.....	608
"Jet Swet"™ Brenelle Jet Packs.....	598
<b>Jiffy Point Screws</b> Shook.....	518
<b>John Crane</b> High Temp Packing.....	361
<b>Johns-Manville</b>	
Z-Tacks.....	515
Zeston PVC Fitting Covers.....	514
<b>Joint Runner</b> Wal-Rich Corporation Non-Asbestos.....	543
<b>Jomar</b> Add-A-Valve®.....	360

### K

<b>Keeney Mfg Co</b>	
Brass Plugs.....	159
Shower Accessories.....	171
Strainers.....	159
<b>Key Set</b> Wal-Rich Corporation T-Handle Hex.....	534
<b>Keys</b> Zurn® Hydrant.....	186, 541
<b>Kickspace Heaters</b> Beacon-Morris®.....	276
<b>Kitchen Cleaners</b> Chemique.....	604
<b>Kitchen Faucets</b>	
Delta.....	28-29
Elkay.....	30
Gerber.....	31
Grohe.....	31
Handles (Chicago).....	24
Kohler.....	32-33
Single-Handle.....	20
Spouts (Chicago).....	24
Two-Handle.....	20-22
<b>Kitchen Sinks</b>	
Cast Iron.....	127
Kohler.....	127
<b>Kneepads</b>	
Irwin® Industrial Tools.....	550
PlumBest®.....	550
<b>Knives</b>	
Lenox Utility.....	587
PlumBest®.....	587
<b>Kohler</b>	
Bathtubs.....	120
Commercial Lavatory Faucets.....	41-42
Commercial Service Faucets.....	52
Decorated Fixtures.....	100
Kitchen Faucets.....	32-33

Kitchen Sinks.....	127
Lavatories.....	85, 87-89, 93-95
Lavatory Faucets.....	38, 40-41, 43
Metering Lavatory Faucets.....	47
Sinks.....	127
Toilet Accessories.....	119-120
Toilets.....	100
Toilets Commercial.....	107
Urinal Flushometers.....	83
Vitreous China Urinals.....	112
Water Fountains.....	12-13
<b>Kohler® Artist Editions</b> Kohler Decorated Fixtures.....	100
<b>KRC-7® Cleaner</b> Chemique.....	604

### L

<b>La-Co</b> Heat Barrier Spray.....	613
<b>Laboratory Faucets</b> Chicago Faucets.....	60
<b>Laboratory Fittings</b> Chicago Faucets.....	62
<b>Lag &amp; Machine Rods</b> .....	521
<b>Lambro Industries</b>	
Dryer Vent Kits.....	255
Dryer Vents.....	255
Flexible Aluminum Ducts.....	255
<b>Lampwick Balls</b> Wal-Rich Corporation.....	543
<b>Laundry Faucets</b>	
Central Brass.....	56
Gerber.....	57
<b>Laundry Pumps</b>	
Hartell Pumps.....	199
Liberty.....	190
Little Giant.....	190
<b>Laundry Tray Pumps</b> Zoeller.....	191
<b>Laundry Tubs</b> EL Mustee.....	96
<b>Lavatories</b>	
Cast Iron Countertop.....	87
Cast Iron Institutional.....	95
Cast Iron Undercounter.....	89
Cast Iron Wall Mount.....	93
Kohler.....	87, 89, 93-95
Kohler Pedestal Vitreous China.....	85
Kohler Vitreous China Undercounter.....	88
Kohler Vitreous China Wall-Mount.....	89
Vitreous China Countertop.....	87
Vitreous China Institutional.....	94
<b>Lavatory Faucets</b>	
Chicago Faucets.....	35, 37-38, 42
Delta.....	37-38, 40
Gerber.....	40
Grohe.....	35, 44
Kohler.....	38, 40-41, 43
Kohler Commercial.....	41-42
Metering.....	45, 47
<b>Lavatory Risers</b> BrassCraft®.....	156
<b>Lavatory Supply Kits</b>	
BrassCraft®.....	156
McGuire Products.....	159-160

Prices & specifications are subject to change.

We offer a variety of GREEN products such as flush valves, faucets, showerheads & more!



## Product Index

Index

<b>Lavatory Faucets</b> Electronic.....	48
<b>Leak Detection</b> Floodmaster.....	219-220
<b>Leak Detector Chemicals</b> Rectorseal®.....	606
<b>Leak Detectors</b> Mannix.....	548
<b>Leak Inhibitors</b> Hercules® Boiler.....	601
<b>Lenox</b>	
Acetylene Kits.....	597
Band Saw Blades.....	582
Brazing Rods.....	597
Hacksaw Frames.....	587
Hand Saws.....	588
Hole Saws.....	589
Solder.....	597
Tubing Cutters.....	574
Utility Knives.....	587
Wood Bit Kits.....	586
<b>Leonard Valve</b>	
Dial Thermometer.....	136
Emergency Mixing Valves.....	134
Mechanical Mixing Valves.....	51, 134
Point-of-Use Valves.....	134
Repair Parts.....	135
Thermostatic Mixing Valves.....	134
<b>Levels</b>	
Douglas® Aluminum.....	531
Rigid.....	531
<b>Liberty</b>	
Laundry Pumps.....	190
Sump Pumps.....	193
Transfer Pumps.....	191
Utility Pump.....	192
<b>Lift Wires</b> Wal-Rich Corporation Brass.....	180
<b>Lights</b> Wal-Rich Corporation Drop.....	531
<b>Liners</b> Noble Co Shower Pan.....	171
<b>Link-Seal</b> Pipe Penetration Sealing.....	482
<b>Little Giant</b>	
Condensate Pumps.....	197
Effluent Pumps.....	196
Laundry Pumps.....	190
Sump Pumps.....	195
Transfer Pumps.....	191
Utility Pump.....	192
<b>Little Giant®</b> Piggyback Switches.....	199
<b>Lochinvar</b>	
Storage Tanks.....	208
Water Heaters.....	204-205
<b>Locknuts</b> Brass Threaded.....	367
<b>Low Water Cutoffs</b> McDonnell & Miller.....	238
<b>Lube Oil</b> JC Whitlam Reach.....	608
<b>Lubricant Sticks</b> Homestead.....	351
<b>Lubricants</b>	
Gunk®.....	607
Hercules®.....	607
Never-Seez®.....	607
PlumBest® Pipe.....	608
Radiator Specialty Liquid Wrench®.....	606
<b>Lunkenheimer</b> Bronze Blow-Off Valves.....	354

## M

<b>Macerating Systems</b> Saniflo.....	114
<b>Machine Bolts</b> .....	517
<b>Machine Rods &amp; Lag</b> .....	521
<b>Maglite</b> Accessories.....	552
<b>Magna Tools</b> Wal-Rich Corporation.....	543
<b>Magnetic Insert Bit Holders</b> Irwin® Industrial Tools.....	584
<b>Magnetic Nutsetters</b> Irwin® Industrial Tools.....	584
<b>Maid-O-Mist</b> Air Valves.....	249
<b>Make-Up Valves</b> Hoffman Specialty.....	242
<b>Malleable Iron Fittings</b>	
Black 150# Threaded.....	438
Black 300# Threaded.....	442
Galvanized 150# Threaded.....	444
<b>Manablocs</b> Viega.....	494
<b>Mannix</b>	
Gas & Leak Detectors.....	548
Infrared Thermometers.....	547
Inspection Mirrors.....	548
<b>MAPP Gas Tank</b> TurboTorch.....	596
<b>Markers</b> Irwin® Industrial Tools Sharpie.....	539
<b>Masks</b> PlumBest® Dust.....	551
<b>Masonry Drill Bits</b> Champion Cutting Tool Corp...	583
<b>McDonnell &amp; Miller</b>	
Blow Down Valves.....	240
Boiler Control Switches.....	240
Electronic Low Water Cutoffs.....	239
Liquid Flow Switches.....	240
Low Water Cutoffs.....	238
Parts.....	241
Water Feeders.....	239
<b>McGuire Products</b>	
Flanges.....	160
P-Traps.....	159
Stop Valves.....	160
Supply Kits.....	159
Tub Spouts.....	172
<b>Mechanical Joint Couplings</b> Flowserve Duriron..	400
<b>Mechanical Joint Tools</b> Orion Fittings.....	401
<b>Mechanical Mixing Valves</b> Leonard Valve.....	51, 134
<b>Mechanical Tees</b> Grinnell®.....	473
<b>Medic-Aid®</b> Lift Seats Church®.....	118
<b>Medical Gas Tubing</b> Copper.....	371
<b>Megapro</b> Screwdrivers.....	532
<b>Mephisto</b>	
Caulking Irons.....	544
Chisels.....	544
<b>Metacaulk®</b> Rectorseal®.....	602
<b>Metering Lavatory Faucets</b>	
Chicago Faucets.....	45
Delta.....	47
Kohler.....	47

Prices & specifications are subject to change.





## Product Index

Symmons.....	47
<b>Midwest Snips</b> Aviation Snips.....	538
<b>Miljoco</b>	
Pressure Gauge Accessories.....	279
Pressure Gauges.....	278
Thermometers.....	280
<b>Mill-Rose</b>	
6-in-1 Tool.....	533
Abrasive Products.....	599
Applicator Brushes.....	547, 599
Dry Box.....	553
Fitting Brushes.....	546
Flue & Boiler Tube Brushes.....	547
Flux.....	613
Heat Shields.....	598
Maintenance Brushes.....	546
Power Brush Adapters.....	546
Power Brushes Hex Shank.....	546
PTFE Thread Sealant Tape.....	608
Sandcloth.....	599
Tool Boxes.....	553
Tube Pipe Cutters.....	574
<b>Milwaukee</b>	
Power Tools Corded.....	580
Power Tools Cordless.....	580-581
Replacement Parts.....	582
<b>Milwaukee®</b>	
Cut-Off Machine Wheels.....	582
Drill Chucks.....	582
Grinder Wheels.....	582
Hex Keys.....	582
Power Tools.....	581-582
<b>Mission Couplings</b> .....	477
<b>Mixing Valves</b>	
Honeywell Water & Steam.....	294
Leonard Valve.....	134
Sloan Optimix®.....	136
Symmons.....	183
Watts Regulator.....	151
<b>Modine</b> Unit Heaters.....	277
<b>Monoflo® Fittings</b> Bell & Gossett Copper Red Ring.....	271
<b>Mop Basins</b> EL Mustee Durastone®.....	97
<b>Motor Couplers</b> Bell & Gossett.....	266
<b>Motors</b> Bell & Gossett Pump.....	266
<b>Mounting Rod</b> Sammy Super Screw™ Threaded.....	525
<b>Multimeters</b> .....	547

### N

<b>Natick Hangers</b> Warwick.....	523
<b>Navien</b>	
Combination Heaters/Water Heaters.....	215
Space Heaters.....	215
Tankless Water Heaters.....	214
Water Heaters.....	214-215
<b>Needle Nose Pliers</b> Channellock®.....	536
<b>Needle Valves</b>	

Prices & specifications are subject to change.

Our state of the art pipe shop offers cutting, threading, grooving and make-ons up to 36in!

BrassCraft®.....	157
Crane.....	356
Vogt.....	357
<b>Neon Chalk Lines</b> PlumBest®.....	539
<b>Neoperl</b> Aerators.....	170
<b>Neutralization &amp; Dilution Tanks</b> Orion Fittings.....	402
<b>Neutralizing Tubes</b> Turbomax.....	235
<b>Never-Seez®</b> Lubricants.....	607
<b>Nibco</b>	
Butterfly Valves.....	350
Copper Stop & Waste Valves.....	358
Fire Prevention Valves.....	352
Iron Check Valves.....	325
Iron Gate Valves.....	323
<b>Nipples</b>	
Black Steel.....	460, 462-463
Chrome Plated Pipe.....	369
CPVC Sch 80.....	413
McGuire Products Brass.....	159
PVC Sch 80.....	413
Stainless Steel.....	468
Std Wgt Galv Steel.....	463
<b>No-Hub Couplings</b> .....	424
<b>No-Hub Couplings</b> Anaco.....	425
<b>Noble Co</b>	
Chloroloy® 240 Shower Pan Liners.....	171
Nobleweld 100.....	171
<b>Nobleweld 100</b> Noble Co.....	171
<b>Nokorode®</b> Rectorseal®.....	613
<b>Nosepieces</b> BrassCraft®.....	157
<b>Nozzle</b> Wal-Rich Corporation Pistol Grip Hose.....	189
<b>Nut Drivers</b>	
Channellock®.....	533
Mill-Rose Power.....	583
Sammy Super Screw™.....	526
<b>Nut Splitters</b> Seekonk Faucet.....	541
<b>Nut Wrenches</b> Wal-Rich Corporation Basin.....	542
<b>Nuts</b> .....	517
<b>Nuts</b>	
Brass Flare.....	498
Caddy® Strut.....	524
Erico® Strut.....	524
Hex.....	517
Insert.....	521
PlumBest®.....	161
PlumBest® Slip-Joint.....	161
Wal-Rich.....	162
<b>Nutsetters</b> Irwin® Industrial Tools.....	584
<b>Nylon Fittings</b> PlumBest®.....	505
<b>Nylon Ties</b> Cable.....	538

### O

<b>O-Rings</b> Gunk®.....	163
<b>Oakum</b> PlumBest®.....	543
<b>Oatey</b>	



## Product Index

Index

Bath Tub Protectors.....	171
PEX Ice Maker Supply Kits.....	170
Pipe Clamps.....	522
Roof Flashing.....	185
Washing Machine Pans.....	182
<b>Offset Wrenches</b> Ridgid.....	554
<b>Offsets</b> Double.....	158
<b>Oil</b>	
Gasola® Penetrating.....	607
Hercules® Lubricating.....	607
JC Whitlam Lube.....	608
Ridgid Cutting.....	572
<b>Oil Absorbants</b> Oil-Dri®.....	545
<b>Oil Boilers</b> Weil-McLain.....	223
<b>Oil Controls</b> Primary.....	285
<b>Oil Tanks</b>	
Granby Residential.....	252
Oil Filters.....	254
<b>Oil-Dri®</b> Premium Absorbants.....	545
<b>Oilers</b> Ridgid Threading Machine.....	572
<b>OneStop™ Wrench</b> .....	557
<b>Open Front with Cover</b> .....	118
<b>Orion Fittings</b>	
Acid Waste Fittings.....	398
Acid Waste Pipe.....	398
Acid Waste Couplings.....	398
Mechanical Joint Tools.....	401
Neutralization & Dilution Tanks.....	402
<b>Overflow Tubes</b> Wal-Rich Corporation.....	179
<b>Overflows</b> Threaded.....	158
<b>Oxy-Acetylene Kits</b> TurboTorch.....	595

### P

<b>P-Traps</b>	
McGuire Products.....	159
PVC DWV.....	406
Schedule 40.....	409
<b>Packing</b> Red Rainbow.....	513
<b>Paint</b> Hercules® Asphalt.....	612
<b>Pans</b> Oatey Washing Machine.....	182
<b>Paper Roller</b> Wal-Rich Corporation Toilet.....	180
<b>Pasco</b> Test Pumps.....	548
<b>Pasco Specialty</b>	
Closet Rings.....	178
Moen® Stem & Cartridge Puller.....	541
Radiator Spud Wrench.....	541
Tools.....	541
<b>Penetrants</b> Radiator Specialty Liquid Wrench®....	606
<b>Penetrating Oil</b> Gasola®.....	607
<b>Permatex®</b> Sealants.....	612
<b>Peterson Products Co</b> Drain Flushers.....	541
<b>Phillips Bits</b> Irwin® Industrial Tools.....	584
<b>Phoenix Forge</b> Steel Tank Flanges.....	252
<b>Pick-up Tools</b> Wal-Rich Corporation.....	542

<b>Piercing Valves</b> BrassCraft®.....	157
<b>Piggyback Switches</b> Little Giant®.....	199
<b>Pigtails</b> Wal-Rich Corporation.....	282
<b>Pilot Gas Valves</b> Honeywell.....	286
<b>Pilots</b> Spence Engineering.....	288
<b>Pipe</b>	
Black Steel.....	433
Black Steel Seamless.....	433-434
Cast Iron No-Hub Soil.....	417
Cast Iron Service Soil.....	417
CPVC CTS.....	414
Fusion.....	426
Fusion Bond Steel.....	434
Galvanized Steel.....	434
Orion Fittings Acid Waste.....	398
ProPress.....	394
PVC Type Pressure.....	403
Sch 10 Black Steel Grooved.....	434
Sch 10 Galvanized Steel Grooved.....	434
Sch 10 Steel Grooved.....	434
Smoke.....	256
<b>Pipe Clamps</b>	
Oatey.....	522
Skinner Emergency.....	480
Superstrut®.....	524
<b>Pipe Compounds</b> JC Whitlam.....	610
<b>Pipe Couplings</b> Dresser Industries.....	478
<b>Pipe Covers</b> Truebro® Lav Guard®2 E-Z.....	161
<b>Pipe Cutter Wheels</b> Ridgid.....	562
<b>Pipe Cutters</b>	
Mill-Rose.....	574
Raven Inside.....	542
Ridgid.....	561
<b>Pipe Dies</b>	
Ridgid.....	568
Ridgid Carrying Case.....	569
<b>Pipe Fittings</b>	
304 Stainless Steel 150# Threaded.....	465
316 Stainless Steel 150# Threaded.....	466
Anoco No-Hub.....	425
Black Cast Iron 125# Flanged.....	437
Brass Compression.....	496
Brass Flare.....	497
Brass Threaded.....	365
Cast Iron Black 125# Threaded.....	435
Cast Iron Black 250# Flanged.....	438
Cast Iron Black 250# Threaded.....	437
Cast Iron Soil No-Hub.....	417
Cast Iron Soil Service.....	420
Chrome-Plated Brass Compression.....	497
CPVC Schedule 80.....	414
Hammond Valve.....	270
Iron Black Malleable 150# Threaded.....	438
Iron Black Malleable 300# Threaded.....	442
Iron Galvanized Malleable 150# Threaded....	444
PVC DWV.....	403
PVC Schedule 40.....	406
PVC Schedule 80.....	409-410
Steel Carbon Weld.....	455
TecTite™.....	384

Prices & specifications are subject to change.



## Product Index

**Pipe Freeze Protection** Raychem Heating Cable. 516

**Pipe Hangers**

- Band Pipe..... 520
- Caddy®..... 524
- Clevis..... 520
- Erico®..... 524
- Flanged Ceiling & Wood Beam..... 521
- Ring..... 519
- Sammy Super Screw™..... 525
- Split Ring..... 519

**Pipe Identification** Brady..... 363

**Pipe Inspecting** Ridgid..... 530

**Pipe Insulation** Fiberglass..... 514

**Pipe Insulation Shields**..... 521

**Pipe Insulation Tape** Rubatex..... 514

**Pipe Lubricants** PlumBest®..... 608

**Pipe Maintenance**

- General Wire Spring Co Cold Shot™ Pipe Freeze..... 579
- General Wire Spring Co Hot Shot™ Pipe Thawing..... 579

**Pipe Markers** Brady..... 363

**Pipe Nipples**

- Black Steel..... 460, 462-463
- Brass..... 368
- Chrome Plated..... 369
- CPVC Sch 80..... 413
- Galvanized Steel..... 463
- PVC Sch 80..... 413
- Stainless Steel..... 468

**Pipe Penetration Sealing** Link-Seal..... 482

**Pipe Plugs**

- Cherne Industries Mechanical..... 184
- Cherne® Mechanical..... 184
- Cherne® Pneumatic..... 184

**Pipe Seal** Gasoila..... 610

**Pipe Stands** Ridgid..... 567

**Pipe Straps**

- 2-Hole Galv..... 518
- Perforated..... 518

**Pipe Taps**

- Wal-Rich Corporation..... 543
- Wal-Rich Corporation Domestic..... 543

**Pipe Thawing** General Wire Spring Co Hot Shot™ 579

**Pipe Thread Sealants**

- Hercules®..... 608-609
- Rectorseal®..... 609

**Pipe Tools**

- Freezing..... 579
- Ridgid..... 563
- Thawing..... 579

**Pipe Wrenches** Rectorseal Internal..... 541

**Piping Systems**

- Grinnell® Copper Grooved..... 474
- Grinnell® Grooved..... 470
- Grinnell® Grooved Fire Protection..... 187

**Plastic Pipe Cements** Hercules®..... 610

**Plastic Pipe Cutters** Mill-Rose..... 574

**Plastic Pipe Primers** Hercules®..... 611

**Plastic Toilet Seats**

- Church®..... 117
- Church® Commercial..... 117

**Pliers**

- Channellock® Cutting..... 536
- Channellock® Linemen's..... 536
- Channellock® Long Nose..... 536
- Channellock® Tongue & Groove..... 535
- Douglas® Slip-Joint..... 537
- Irwin® Industrial Tools Groovelock..... 537
- Irwin® Industrial Tools Locking..... 537

**Plug Valve Wrenches** Homestead..... 351

**Plug Valves** Homestead Steel..... 351

**Plugs**

- Cherne Industries Mechanical Pipe..... 184
- Cherne® Mechanical Pipe..... 184
- Cherne® Pneumatic Pipe..... 184
- Clean Seal..... 184
- Cleanout..... 424
- Kwik'N Sure® Mechanical Pipe..... 184
- PlumBest® Basin & Tub Stoppers..... 172
- Radiator Specialty Drain..... 172
- Steel Countersunk Hex..... 453
- Wal-Rich Corporation..... 185

**Plumb Bobs** Brass..... 538

**Plumber's Grease** Gunk® Heat-Pruf..... 607

**PlumBest** Drain Cleaners..... 605

**PlumBest®**

- Bolts..... 518
- Brass Hose Barbs..... 189, 506
- Brass Hose Fittings..... 188, 506
- Brushes..... 547
- Cleanout Spuds..... 170
- Closet Flange Spacers..... 181
- Decorative Strainers..... 172
- Disposable Coveralls..... 551
- Drain Bodies..... 169
- Drain Stoppers..... 172
- Dust Masks..... 551
- Escutcheons..... 161
- Garden Hose..... 189
- Kneepads..... 550
- Knives..... 587
- Neon Chalk Lines..... 539
- Nuts and Washers..... 161
- Nylon Fittings..... 505
- Oakum..... 543
- Pipe Lubricants..... 608
- Service Sink Accessories..... 159
- Shop Towels..... 539
- Shower Rods..... 171
- Straps..... 538
- Toilet Tank Levers..... 175
- Trash Bags..... 539
- Tub Spouts..... 173
- Work Gloves..... 550
- Wrenches..... 534

**Plumbing Vents** Wal-Rich Corporation Automatic 185

**Plungers** Gunk® Toilet..... 542

**Pneumatic Pipe Plugs** Cherne®..... 184

**Pocket Knives**..... 587

Prices & specifications are subject to change.

Metropolitan Pipe offers FREE DELIVERY in the Greater Boston area.



## Product Index

Index

<b>Point-of-Use Valves</b> Leonard Valve.....	134
<b>Poppet Valves</b> Watts Regulator.....	143
<b>Pot Fillers</b> T&S Brass.....	26
<b>Powell</b>	
Cast Steel Check Valves .....	332
Stainless Steel Check Valves .....	344, 346
Stainless Steel Gate Valves .....	344
<b>Power Bits</b>	
Irwin® Industrial Tools.....	584
Mill-Rose Nut Drivers.....	583
<b>Power Brushes</b> Mill-Rose Hex Shank.....	546
<b>Power Generators</b> Honeywell.....	284
<b>Power Threaders</b> Ridgid.....	570
<b>Power Tools</b>	
Milwaukee.....	580-581
Milwaukee®.....	581-582
<b>Powers</b>	
Accritem® Temperature Controllers .....	288
Self-Operating Regulators.....	287
Sensing Bulbs and Protective Wells .....	288
Thermal Regulators.....	287
<b>PPP Manufacturing Co</b> Drain Stoppers.....	172
<b>Pre-Rinse Faucets</b> Chicago Faucets.....	23
<b>Pre-Rinse Units</b> T&S Brass.....	25
<b>Precision Plumbing Products</b>	
Distribution Units.....	154
Primer Valves.....	154
<b>Press Ball Valves</b> Apollo.....	303
<b>Press Jaws</b> Ridgid.....	396, 576
<b>Press Rings</b> Ridgid.....	396, 576
<b>Press Tools</b> Ridgid.....	395, 575
<b>Pressure Gauges</b> Miljoco.....	278
<b>Pressure Pipe</b> Type PVC.....	403
<b>Pressure Reducing Valves</b> Bell & Gossett.....	270
<b>Pressure Regulators</b>	
Watts Regulator.....	136
Watts Regulator Steam .....	138, 290
<b>Pressure Relief Valves</b> Watts Regulator.....	139, 143
<b>Pressure Steam Packing</b> John Crane.....	361
<b>Pressure Valves</b> Armstrong®.....	290
<b>Pressuretrol®</b> Honeywell Controllers.....	283
<b>Pressuretrol® Controllers</b> Honeywell.....	283
<b>Primer Valves</b> Precision Plumbing Products .....	154
<b>Propane Tank</b> TurboTorch.....	596
<b>ProPress</b>	
Fittings.....	385, 387-388, 390, 392
Pipe.....	394
Stainless Steel Fittings .....	390, 392
Stainless Steel Pipe.....	394
<b>ProRadiant</b>	
Actuators.....	491
Climate Panel System.....	490
Controls.....	491
Fasteners.....	487
Fittings.....	485

Tools & Accessories .....	487
Tubing.....	484
Valves.....	491
<b>ProSet Systems Inc</b> Trap Guard® Inserts.....	181
<b>ProTech Systems Inc</b> FasNSeal® Venting Systems.....	256
<b>Pump Motors</b> Bell & Gossett.....	266
<b>Pump Parts</b> Zoeller.....	199
<b>Pump Power Packs</b> Bell & Gossett.....	266
<b>Pump Seals</b> Bell & Gossett.....	266
<b>Pump Switches</b> Hartell Pumps Laundry.....	199
<b>Pump Valves</b> Zoeller Unichcks.....	198
<b>Pumps</b>	
Bell & Gossett Circulator .....	265
Hartell Pumps Laundry.....	199
Hoffman Specialty Condensate .....	242
Liberty Laundry.....	190
Little Giant Laundry.....	190
Little Giant® Piggyback Switches .....	199
Pasco Test.....	548
Wheeler Rex Test.....	548
Zoeller.....	191
<b>PureFlow</b>	
Actuators.....	491
Controls.....	491
Fasteners.....	487
Fittings.....	485
Tools & Accessories .....	487
Tubing.....	484
Valves.....	491
<b>PureFlow Jaws</b> Ridgid.....	396, 576
<b>Purge Valves</b> Watts Regulator .....	152
<b>Putty</b> Hercules®.....	603
<b>PVC Ball Valves</b> Spears.....	309
<b>PVC Cements</b> Hercules®.....	610
<b>PVC DWV Closet Flanges</b> Raven.....	179
<b>PVC Fittings</b>	
DWV .....	403
Nipples Sch 80.....	413
Schedule 40.....	406
Schedule 80.....	409-410
<b>PVC Hangers</b> Warwick.....	523
<b>PVC Pipe</b> Type Pressure.....	403
<b>PVC Primers</b> Hercules®.....	611
<b>PVC Valves</b>	
Spears Ball.....	310
Spears Check.....	309

## Q

<b>Qwik Jon®</b> Sewage Removal System.....	116
---	-----



## Product Index

### R

<b>Rackmaster Handrail Fittings</b> .....	511
<b>Radiant Heating</b>	
Slant/Fin.....	271-272
Slant/Fin Elements.....	273
<b>Radiator Coin Key Air Valves PlumBest®</b> .....	251
<b>Radiator Handles Wal-Rich Corporation</b> .....	543
<b>Radiator Repair Tools Wal-Rich Corporation</b> .....	541
<b>Radiator Specialty</b>	
Beveled Cone Washers.....	164
Drain Plugs.....	172
Lubricants & Penetrants.....	606
Spud Washers.....	179
Toilet Repair Parts.....	178
Vinyl Tubing.....	505
<b>Radiator Spud Wrenches Wal-Rich Corporation</b> ..	542
<b>Radiator Valve Actuators Honeywell</b> .....	292
<b>Radiator Valves</b>	
A Y McDonald Bronze.....	358
AY McDonald Industrial.....	270
Danfoss Valves & Accessories.....	295
Heat-Timer.....	248
Honeywell.....	291
<b>Radiator Vents Armstrong®</b> .....	248
<b>Rags PlumBest® Cotton Shop Towels</b> .....	539
<b>Raven</b>	
Brass Boiler Valves.....	359
Gas Vent Signs.....	255
Inside Pipe Cutters.....	542
Isolation Flanges.....	264
Symmons Valve Wrench.....	542
<b>Raychem Heating Cable</b> .....	516
<b>Reamers Ridgid</b> .....	563
<b>Reciprocating Saw Blades Lenox</b> .....	592
<b>Rectorseal®</b>	
Cold Galvanizing Spray.....	612
Firestopping Products.....	602
Flux.....	613
Leak Detectors.....	606
Metacaulk®.....	602
Nokorode®.....	613
Sealants.....	609
Thread Sealants.....	609
<b>Red Baron Circulators Taco Inc</b> .....	263
<b>Refill Tubes Wal-Rich Corporation</b> .....	180
<b>Refrigeration Temperature Controls Honeywell</b> ..	284
<b>Refrigeration Tubing Copper</b> .....	370-371
<b>Regulators</b>	
Powers Thermal.....	287
TurboTorch.....	596
Watts FluidAir Compressed Air.....	296
Watts FluidAir Miniature FRL.....	296
Watts Regulator.....	136
Watts Regulator Steam Pressure.....	138, 290

<b>Relays</b>	
Honeywell Switching.....	284
Taco.....	237
<b>Relief Valves</b>	
Bell & Gossett Pressure.....	270
Watts Regulator.....	139, 142-143
<b>Repair Couplings Mission</b> .....	478
<b>Repair Fittings Couplings</b> .....	478
<b>Repair Tools Wal-Rich Corporation Radiator</b> .....	541
<b>Reznor Hooks</b> .....	522
<b>Ridgid</b>	
Groovers.....	573
Lever Benders.....	564
Manual Threaders.....	568
Pipe Cutters.....	561
Pipe Inspecting.....	530
Pipe Tools.....	563, 566
Power Threaders.....	570
Press Jaws.....	396, 576
Press Rings.....	396, 576
Press Tools.....	395, 575
PureFlow Jaws.....	396, 576
Spring-Type Benders.....	565
Tape Measures.....	531
Threader Oil.....	572
Tools.....	531, 563, 566
Tube Benders.....	565
Tubing Cutters.....	558
Tubing Tools.....	564
Wet/Dry Vacuums.....	575
Wrenches.....	554
<b>Ring Hangers</b>	
Pipe.....	519
Split.....	519
<b>Riser Air Valves Vent-Rite</b> .....	248
<b>Riser Clamps</b> .....	520
<b>Risers</b>	
BrassCraft® Closet.....	157
BrassCraft® Lavatory.....	156
<b>Rock Marble Chips</b> .....	545
<b>Rod Hangers Sammy Super Screw™ Threaded</b> ...	525
<b>Rods</b>	
Lenox Brazing.....	597
Machine & Lag.....	521
PlumBest® Shower.....	171
Threaded.....	517
Wal-Rich Corporation Brass Ballcock.....	180
<b>Rogers Gas Testers</b> .....	548
<b>Roll Form Markers Brady</b> .....	363
<b>Roof and Flashing Sealants Hercules®</b> .....	602
<b>Roof Flashing No-Calk®</b> .....	185
<b>Rubatex</b>	
Pipe Insulation.....	514
Pipe Insulation Tape.....	514
<b>Rubber Repair Couplings Mission</b> .....	478
<b>Rules Ridgid</b> .....	531
<b>Ruud</b>	
Commercial Electric Water Heaters.....	206-207
Commercial Gas Water Heaters.....	204-205



## Product Index

Residential Electric Water Heaters .....	202-203
Residential Gas Water Heaters .....	201-202
Storage Tanks.....	208
Water Heaters.....	201-207

### S

#### Safety

Ear Plugs.....	549
Glasses.....	549
Headwear.....	550
<b>Safety Relief Valves</b> Watts Regulator.....	139, 142-143
<b>Safety Shower &amp; Eye Wash</b> Guardian Equipment	133
<b>Safety Stations</b> Guardian Equipment.....	133
<b>Sammy Super Screw™</b>	
Drill Bits.....	526
Nut Drivers.....	526
Sidewinder™ Mounts.....	525
Threaded Rod Hangers.....	525
<b>Sandcloth</b> Mill-Rose.....	599
<b>Saniflo</b> Macerating Systems.....	114
<b>Saniflow</b> Grinding Systems.....	114
<b>SaniGuard</b> Sanitizing Sprays.....	604
<b>Sanitizing Sprays</b> SaniGuard.....	604
<b>Saw Blades</b>	
Lenox.....	588
Lenox Band Saw.....	582
Lenox Hacksaw.....	588
Lenox Reciprocating.....	592
<b>Saw Wheels</b> Milwaukee® Chop.....	582
<b>Saws</b>	
Lenox Hacksaw.....	587
Lenox Hole.....	589
Milwaukee® Electric Band.....	582
<b>Sawzall®</b> Milwaukee®.....	581
<b>Screw Extractors</b> Wal-Rich Corporation.....	543
<b>Screw Kits</b> Shook Sheet Metal.....	518
<b>Screwdrivers</b>	
Channellock®.....	533
Megapro.....	532
Megapro Tamperproof.....	532
Mill-Rose 6-in-1.....	533
<b>Screws</b>	
Drive.....	522
Gunk® Faucet.....	163
Shook Jiffy Point.....	518
Wal-Rich Corporation Brass Closet.....	180
<b>Seal Plugs</b> Cherne®.....	184
<b>Sealant Tape</b> Mill-Rose PTFE Thread.....	608
<b>Sealants</b>	
Chatham Silicone.....	602
Gunk® Boiler Seal.....	601
Hercules®.....	602
Hercules® Caulk.....	602
Hercules® Epoxy.....	599
Hercules® Putty.....	603

Hercules® Roof and Flashing.....	602
Hercules® Thread.....	608-609
Permatex®.....	612
Rectorseal® Pipe Thread.....	609
<b>Seat Wrenches</b> Wal-Rich Corporation.....	542
<b>Seats</b>	
Church® Medic-Aid® Toilet.....	118
Church® Plastic Toilet.....	117
Church® Wood Toilet.....	117
<b>Seekonk</b>	
Faucet Nut Splitters.....	541
Torque Wrenches.....	541
<b>Sensing Bulbs</b> Powers.....	288
<b>Sensors</b> tekmar® Controls.....	236
<b>Service Sink Accessories</b> PlumBest®.....	159
<b>Service Sink Faucets</b>	
Central Brass.....	56
Chicago Faucet.....	53, 57
<b>Sewage Basins</b> Zoeller.....	199
<b>Sewage Pumps</b> Zoeller.....	197
<b>Sewage Removal Systems</b> Zoeller Pumps.....	116
<b>Sharpie</b> Markers.....	539
<b>Sheet Metal Screw Kits</b> Shook.....	518
<b>Sheet Metal Screws</b> Shook.....	518
<b>Shields</b> Pipe Insulation.....	521
<b>Shook</b>	
Sheet Metal Screw Kits.....	518
Sheet Metal Screws.....	518
<b>Shop Towels</b>	
PlumBest®.....	539
PlumBest® Cotton.....	539
<b>Shower &amp; Tub Modules</b> Sterling Vikrell™.....	122
<b>Shower Accessories</b>	
Bar Slides.....	76
Outlet Components.....	76
Pin Wall Mounts.....	76
Replacement Gaskets.....	76
Shower Arm Mounts.....	75
Shower Hoses.....	75
Swivel Connectors.....	75
Wall Bars.....	75
Water Diverters.....	76
<b>Shower Arm Mounts</b> .....	75
<b>Shower Arms</b> Chatham Brass.....	171
<b>Shower heads</b> Alsons.....	72
<b>Shower Heads</b>	
Chatham Brass.....	72
Hansgrohe.....	73
Sloan Act-O-Matic.....	72
<b>Shower Hoses</b> .....	75
<b>Shower Modules</b> Sterling Vikrell™.....	121
<b>Shower Pan Liners</b> Noble Co.....	171
<b>Shower Pin Wall Mounts</b> .....	76
<b>Shower Rod Flanges</b> Keeney Mfg Co.....	171
<b>Shower Rods</b>	
Keeney Mfg Co.....	171
PlumBest®.....	171



## Product Index

<b>Shower Systems</b> Symmons.....	65-66
<b>Shower Wall Bars</b> .....	75
<b>Shower Water Diverters</b> .....	76
<b>Showerhead Valves</b> Chicago Faucets.....	72
<b>Showerheads</b> Speakman.....	74
<b>Showers</b>	
Alsons Hand-Held.....	74
Aquatic.....	123
Guardian Equipment Emergency.....	133
<b>Shut-Off Valves</b> Watts Regulator Washing Machine.....	182
<b>Side Beam Hangers</b> .....	519
<b>Sidewinder™ Mounts</b> Sammy Super Screw™.....	525
<b>Signs</b> Raven Gas Vent Warning/Identification.....	255
<b>Silicone Sealants</b> Chatham Brass.....	602
<b>Sillcocks</b> Chicago Faucets.....	59
<b>Silvabrite 100® Lead-Free Solder</b> .....	598
<b>Silver King Mfg</b> Squick Boiler Cleaner.....	600
<b>Single Hole Faucets</b> Grohe.....	35
<b>Sink Accessories</b> PlumBest® Service Sink.....	159
<b>Sink Faucets</b>	
Kohler Commercial.....	52
Speakman®.....	52
<b>Sink Risers</b> BrassCraft®.....	156
<b>Sink Supply Kits</b> BrassCraft®.....	156
<b>Sinks</b>	
Elkay Kingsford® Stainless Steel Kitchen.....	127
Elkay Stainless Steel Bar.....	127
Elkay Stainless Steel Kitchen.....	125
Kohler.....	127
Kohler Pedestal Lavatory Vitreous China.....	85
Kohler Vitreous China Undercounter Lavs.....	88
Kohler Vitreous China Wall-Mount Lavatories.....	89
<b>Siphon Pigtails</b> Wal-Rich Corporation.....	282
<b>Skinner Co</b> Emergency Pipe Clamps.....	480
<b>Slant/Fin</b>	
Baseboard Radiation.....	271-272
Element Hanger Brackets.....	273
Elements.....	273
Expansion Couplings.....	274
<b>Slip-Joint Nuts</b> PlumBest®.....	161
<b>Slip-Joint Pliers</b> Douglas®.....	537
<b>Slip-Joint Washers</b> Gunk®.....	163
<b>Sloan</b>	
Flush Valves.....	77, 79
Optima Plus™ Retro Fit Conversion Kits.....	79
Optimix® Below Deck Mixing Valves.....	136
Shower Heads.....	72
Transformers.....	81
WES Waterfree Urinals.....	113
<b>Sloan Valve</b>	
Flushometer Sweat Solder Kits.....	83
Flushometers.....	82
<b>Smoke Pipe Fittings</b> .....	257
<b>Snips</b>	
Lenox.....	538
Midwest Snips.....	538

<b>Soil Pipe</b> Cast Iron.....	417
<b>Soil Pipe Cutter Chains</b> Ridgid.....	563
<b>Soil Pipe Cutters</b> Ridgid.....	562
<b>Soil Pipe Fittings</b>	
Cast Iron No-Hub.....	417
Cast Iron Service.....	420
<b>Solder</b> Lenox.....	597
<b>Solder Ladles</b> Wal-Rich Corporation.....	543
<b>Solder Pot</b> Wal-Rich Corporation Cast Iron.....	544
<b>Solder Supplies</b>	
BernzOmatic®.....	594
BernzOmatic® Torches.....	594
Brenelle "Jet Swet"™.....	598
Goss® Trigger Torch.....	594
Mill-Rose.....	598
Rectorseal® Flux.....	613
TurboTorch.....	594-597
<b>Solders</b> Wolverine.....	598
<b>Space Heaters</b> Navien.....	215
<b>Spade Bits</b> Irwin® Industrial Tools.....	586
<b>Speakman®</b> Sink Faucets.....	52
<b>Spears</b>	
CPVC Ball Valves.....	310
PVC Ball Valves.....	309-310
PVC Check Valves.....	309
<b>Specialty Fittings</b>	
End Caps.....	479
Mission Couplings.....	477
Transition Couplings.....	477
<b>Specialty Valves</b> Apollo.....	303
<b>Speedbor® Spade Bits</b> Irwin® Industrial Tools....	586
<b>SpeedFill</b>	
Alarms.....	254
Caps.....	252
Connectors.....	252
Fire Safety Valves.....	253
Gauges.....	254
Vent Caps.....	253
<b>Speedfit Fittings</b> .....	502-503
<b>Spence Engineering</b>	
Pilots.....	288
Thermostat Bulbs.....	290
Thermostat Wells.....	290
<b>Spiral Wound Gaskets</b> Flexitallic.....	513
<b>SpiroTherm</b>	
Spirotop® Air Releases.....	249
Spirovent® Air Releases.....	250
Spirovent® Jr Air Eliminators.....	250
<b>Split Ring Hangers</b> .....	519
<b>Split Ring Hangers</b>	
Caddy®.....	525
Erico®.....	525
<b>Spools</b> Wal-Rich Corporation Non-Asbestos Graphite Packing.....	543
<b>Spouts</b>	
McGuire Products Tub.....	172
PlumBest® Tub.....	173
T&S Brass Faucet.....	27

Prices & specifications are subject to change.

Our faucet parts counter is one of the largest in the Boston area with thousands of parts in stock!



## Product Index

Index

<b>Spring Nuts</b> Superstrut®.....	523	Sch 10 Black Grooved.....	434
<b>Sprinkler Head Cabinets</b> Tyco Fire & Building.....	186	Sch 10 Galvanized Grooved.....	434
<b>Sprinklers</b>		Sch 10 Grooved.....	434
Tyco.....	187	Stainless.....	465
Tyco Fire & Building.....	187	<b>Steel Valves</b>	
<b>Spud Rings</b> Wal-Rich Corporation.....	180	Apollo Ball.....	304
<b>Spud Washers</b> Radiator Specialty.....	179	Edwards Blow-Off.....	354
<b>Spud Wrench</b> Pasco Specialty Radiator.....	541	Flowseal Butterfly.....	350
<b>Spud Wrenches</b>		Homestead Plug.....	351
Ridgid.....	556	<b>Steel Wool</b> .....	599
Wal-Rich Corporation, Radiator.....	542	<b>Steel-O-Lets</b> Forged Steel.....	447
<b>Spuds</b>		<b>Stem Puller</b> Pasco Specialty Moen® Cartridge.....	541
PlumBest® Drain Cleanout.....	170	<b>Sterling - A Kohler Company</b>	
Wal-Rich Corporation Closet.....	180	Vikrell™ Shower Modules.....	121
<b>Stainless Steel Fittings</b>		Vikrell™ Tub & Showers.....	122
304/SS 150# Threaded.....	465	<b>Stop &amp; Waste Valves</b>	
316/SS 150# Threaded.....	466	Hammond Brass.....	359
Pipe Nipples.....	468	Nibco Copper.....	358
ProPress.....	390, 392	<b>Stop Valves</b>	
<b>Stainless Steel Pipe</b> .....	465	BrassCraft®.....	155
<b>Stainless Steel Sinks</b>		BrassCraft® Integral Shut-Off.....	156
Elkay Bar.....	127	BrassCraft® Water Ball.....	155
Elkay Kingsford® Kitchen.....	127	McGuire Products.....	160
Elkay Kitchen.....	125	<b>Stoppers</b>	
<b>Stainless Steel Valves</b>		PlumBest® Basin & Tub.....	172
Apollo Ball.....	306	Radiator Specialty Drain.....	172
Powell Check.....	346	<b>Storage Mill-Rose</b> .....	553
<b>Stands</b> Ridgid Pipe.....	567	<b>Storage Tanks</b>	
<b>Steam Pressure Regulators</b> Watts Regulator.....	138, 290	Lochinvar.....	208
<b>Steam Siphons</b> Wal-Rich Corporation.....	282	Ruud.....	208
<b>Steam Traps</b>		<b>Stove Cement</b> Hercules®.....	603
Armstrong®.....	243, 245	<b>Strainers</b>	
Armstrong® Disc.....	243	Apollo Valves Y.....	151
Armstrong® Float & Thermostatic.....	244	Bar Sink.....	165
Armstrong® Inverted Bucket.....	243	Grinnell® Grooved.....	474
Barnes & Jones.....	246	Keeney Mfg Co Miscellaneous.....	159
Hoffman Specialty.....	247	Kitchen.....	165
<b>Steam Valves</b> AY McDonald Industrial.....	270	PlumBest® Decorative.....	172
<b>Steam Vents</b>		Watts Regulator Commercial "Y".....	150
Hoffman Specialty Main.....	249	<b>Strap Wrenches</b> Ridgid.....	556
Hoffman Specialty Special.....	249	<b>Straps</b>	
<b>Steel Couplings</b> Dresser Industries.....	478	Pipe.....	518
<b>Steel Fittings</b>		PlumBest®.....	538
Black Steel.....	462	PlumBest® Utility.....	538
Black Steel Nipples.....	460, 463	<b>Strataflo</b> Brass Foot Valves.....	360
Forged 2000#.....	455	<b>Strut</b>	
Forged Flanges 150#.....	448	Clevis Hangers.....	520
Forged Flanges 1500#.....	452	Superstrut®.....	523
Forged Flanges 300#.....	450	<b>Strut Nuts</b>	
Forged Flanges 3000#.....	452	Caddy®.....	524
Forged Flanges 600#.....	451	Erico®.....	524
Galvanized.....	463	<b>Strut Supports</b>	
Stainless Steel Fittings.....	468	Caddy®.....	524
Steel Carbon Weld.....	455	Erico®.....	524
<b>Steel Pipe</b>		<b>Sump Pump Hose</b> Wal-Rich Corporation Drain....	199
Black.....	433	<b>Sump Pumps</b>	
Black Seamless.....	433-434	Liberty.....	193
Fusion Bond.....	434	Little Giant.....	195
Galvanized.....	434	Zoeller.....	193-195

Prices & specifications are subject to change.





## Product Index

<b>SuperStor HTP</b>	
Indirect Water Heaters.....	211
Water Heaters.....	211
<b>Superstrut®</b>	
Clamps & Hangers.....	524
Cone Nuts.....	523
Metal Framing Channels.....	523
Spring Nuts.....	523
Threaded Products.....	523
<b>Supply Kits</b>	
BrassCraft®.....	156
McGuire Products.....	159
Oatey Pex Tubing.....	170
<b>Supply Valves Hoffman Specialty.....</b>	<b>296</b>
<b>Switches</b>	
Firomatic Thermal.....	254
Little Giant® Piggyback.....	199
McDonnell & Miller Boiler Control.....	240
McDonnell & Miller Liquid Flow.....	240
<b>Switching Relays Taco.....</b>	<b>237</b>
<b>Swivel Base Faucets T&amp;S Brass.....</b>	<b>26</b>
<b>Swivel Shower Connectors.....</b>	<b>75</b>
<b>Swivels Handrail Fittings.....</b>	<b>511</b>
<b>Symmons</b>	
Allura™ Shower Systems.....	65
Metering Lavatory Faucets.....	47
Mixing Valves.....	183
Shower Systems.....	65-66
Temptrol® Packaged Units.....	64
<b>Symmons Valve Wrenches Raven.....</b>	<b>542</b>

### T

<b>T&amp;P Valves Watts Regulator.....</b>	<b>142</b>
<b>T&amp;S Brass</b>	
Faucet Goosenecks.....	27
Faucet Nozzles.....	27
Glass Fillers.....	26
Pot Fillers.....	26
Pre-Rinse Units.....	25
Swivel Base Faucets.....	26
Work Board Faucets.....	26
<b>Taco</b>	
Switching Relays.....	237
Zone Valve Controls.....	237
<b>Taco Inc</b>	
Automatic Air Vents.....	250
Cartridge Circulators.....	262
Flo-Chek Valves.....	269
Freedom Flanges.....	264
Red Baron Circulators.....	263
Zone Valves.....	269
<b>Tailpieces</b>	
Flanged.....	157
Threaded.....	158
<b>Tank Balls</b>	
TITE-SEAL®.....	179
Triple Seal.....	179

<b>Tank Covers Chicago Specialty.....</b>	<b>175</b>
<b>Tank Flanges Phoenix Forge Steel.....</b>	<b>252</b>
<b>Tank Levers</b>	
Fluidmaster® Toilet.....	175
PlumBest® Toilet.....	175
Wal-Rich Corporation CP Crown.....	175
<b>Tankless Heaters TFI Everhot.....</b>	<b>235</b>
<b>Tankless Water Heater Valves Watts Regulator..</b>	<b>152</b>
<b>Tanks</b>	
Expansion Tanks.....	219
Granby Oil Residential.....	252
Orion Fittings Neutralization & Dilution.....	402
TurboTorch.....	596
Watts.....	219
<b>Tape</b>	
Electrical.....	553
Hercules® Pipe.....	608-609
Mill-Rose PTFE Thread Sealant.....	608
Rubatex Pipe Insulation.....	514
<b>Tape Measures Ridgid.....</b>	<b>531</b>
<b>Taps</b>	
Wal-Rich Corporation Domestic Pipe.....	543
Wal-Rich Corporation Pipe.....	543
<b>Tasco</b>	
Flocontrol Valves.....	356
Instrumentation Valves.....	356
<b>TecTite™</b>	
Copper Fittings.....	384
Tools.....	384
<b>Tees.....</b>	<b>158</b>
<b>Tees Handrail Fittings.....</b>	<b>508</b>
<b>tekmar® Controls</b>	
Boiler/DHW Controls.....	236
Sensors.....	236
<b>Temperature Controls</b>	
Honeywell.....	284
Honeywell Proportional.....	284
Powers Accritem®.....	288
<b>Temperature Valves Armstrong®.....</b>	<b>290</b>
<b>Tempering Valves Sloan.....</b>	<b>136</b>
<b>Tempering/Mixing Valves Watts Regulator.....</b>	<b>151</b>
<b>Temptrol® Packaged Units Symmons.....</b>	<b>64</b>
<b>Test Cocks Watts Regulator.....</b>	<b>149</b>
<b>Test Equipment Watts Regulator Backflow Preventers.....</b>	<b>147</b>
<b>Test Kits Hercules®.....</b>	<b>600</b>
<b>Test Plugs</b>	
Cherne®.....	184
Watts Regulator Hydronic.....	153
<b>Test Pumps</b>	
Pasco.....	548
Wheeler Rex.....	548
<b>Testers Rogers Gas.....</b>	<b>548</b>
<b>TFI Everhot Tankless Heaters.....</b>	<b>235</b>
<b>Thermal Regulators Powers #11 Self-Operating..</b>	<b>287</b>
<b>Thermal Switches Firomatic.....</b>	<b>254</b>
<b>Thermocouples Honeywell.....</b>	<b>284</b>

Prices & specifications are subject to change.

Our office hours are 7am to 4:30pm and counter hours 6am to 4:30pm Monday through Friday.



## Product Index

Index

<b>Thermometers</b>		
Mannix.....	547	
Miljoco.....	280	
<b>Thermostat Bulbs</b> Spence Engineering.....	290	
<b>Thermostat Wells</b> Spence Engineering.....	290	
<b>Thermostatic Mixing Valves</b>		
Honeywell.....	294	
Leonard Valve.....	134	
<b>Thermostatic Radiator Valves</b>		
Danfoss.....	295	
Honeywell.....	291	
<b>Thermostatic Steam Traps</b>		
Armstrong®.....	244	
Barnes & Jones.....	246	
Hoffman Specialty.....	247	
<b>Thermostatic Valve Actuators</b> Honeywell.....	292	
<b>Thermostats</b>		
Danfoss Radiator Valve.....	295	
Honeywell.....	283	
Honeywell Non-Programmable.....	283	
<b>Thread Cutting Oil</b> Ridgid.....	572	
<b>Thread Sealant Tape</b> Mill-Rose PTFE.....	608	
<b>Thread Sealants</b>		
Hercules®.....	608-609	
Rectorseal®.....	609	
<b>Thread-O-Lets</b> Forged Steel 3000#.....	447	
<b>Threaded Rod Hangers</b> Sammy Super Screw™..	525	
<b>Threaded Rods</b> .....	517	
<b>Threader Oil</b> Ridgid.....	572	
<b>Threaders</b>		
Ridgid Manual.....	568	
Ridgid Power.....	570	
<b>Ties</b> Nylon Cable.....	538	
<b>Tin Clips</b> .....	518	
<b>Toilet Accessories</b>		
Kohler.....	119	
Kohler Commercial.....	120	
<b>Toilet Bolts</b> Hercules®.....	177	
<b>Toilet Bowl Rings</b> Gunk® Kant-Leak®.....	178	
<b>Toilet Bowls</b> Kohler Commercial.....	107	
<b>Toilet Connectors</b> Fluidmaster®.....	175	
<b>Toilet Flange Extensions</b> J-Tec Products Company.....	178	
<b>Toilet Flange Spacers</b> PlumBest®.....	181	
<b>Toilet Flanges</b> J-Tec Products Company.....	178	
<b>Toilet Flappers</b>		
Korky®.....	174	
Seal-O-Matic®.....	174	
Sealmaster®.....	174	
<b>Toilet Gaskets</b>		
Hercules®.....	178	
Radiator Specialty.....	178	
<b>Toilet Lids</b> Chicago Specialty.....	175	
<b>Toilet Paper Roller</b> Wal-Rich Corporation.....	180	
<b>Toilet Parts</b>		
Cesco Brass Ballcocks.....	173	
Cesco Brass Douglas Flush Valve.....	173	
Closet Bolts.....	179	
Fluidmaster®.....	174-175	
Fluidmaster® Fill Valves.....	173	
Harvey.....	176	
Radiator Specialty.....	178	
Sloan Flush Valves.....	77, 79	
Tank Balls.....	179	
Zurn® Gaskets.....	180	
<b>Toilet Plungers</b> Gunk®.....	542	
<b>Toilet Risers</b> BrassCraft®.....	157	
<b>Toilet Seats</b>		
Church®.....	117	
Church® Medic-Aid® Lift.....	118	
Kohler.....	119	
<b>Toilet Supply Kits</b>		
BrassCraft®.....	156	
McGuire Products.....	160	
<b>Toilet Tanks</b> Kohler Commercial.....	107	
<b>Toilets</b>		
Kohler 1-Piece Residential.....	100	
Kohler Commercial.....	107	
Kohler Commercial Seats.....	120	
Sterling.....	108	
<b>Tool Bags</b> Irwin® Industrial Tools.....	552	
<b>Tool Boxes</b>		
Mill-Rose.....	553	
Mill-Rose Dry Box.....	553	
<b>Tools</b>		
Barnes & Jones Cover Wrenches.....	247	
Crimpers.....	538	
Douglas®.....	542	
Fusion Piping.....	431	
General Purpose.....	534	
Irwin® Industrial Tools.....	535, 537, 584-586	
Knives.....	587	
Lenox.....	538, 574, 582, 586-589, 591-593	
Megapro.....	532	
Midwest Snips.....	538	
Mill-Rose.....	547, 599	
Milwaukee®.....	581-582	
Multi-Tools.....	534	
Pasco Specialty.....	541	
Pipe Freezing.....	579	
Pipe Thawing.....	579	
PlumBest®.....	534, 540	
Pocket Knives.....	587	
Reciprocating Blades.....	593	
Ridgid.....	531, 554, 563-564, 566	
Screwdrivers.....	532	
Seekonk Nut Splitters.....	541	
Seekonk Torque Wrenches.....	541	
Specialty Screwdrivers.....	532	
Tamperproof Screwdrivers.....	532	
TecTite™.....	384	
<b>Torches</b>		
BernzOmatic®.....	594	
Goss® Trigger Torch.....	594	
TurboTorch.....	594-595	
<b>Torpedo Levels</b> Ridgid.....	531	
<b>Torque Wrenches</b> Seekonk.....	541	

Prices & specifications are subject to change.

Metropolitan Pipe offers FREE DELIVERY in the Greater Boston area.



## Product Index

<b>Towels PlumBest® Shop</b> .....	539
<b>Transfer Pumps</b>	
Liberty.....	191
Little Giant.....	191
<b>Transformers</b>	
Electronic Lavatory Faucet.....	51
Honeywell.....	286
Sloan.....	81
<b>Transition Couplings Rubber</b> .....	477
<b>Trap Covers Truebro® Lav Guard®2 E-Z</b> .....	161
<b>Trap Guard® Inserts ProSet Systems Inc</b> .....	181
<b>Trap Primer Distribution Units Precision Plumbing Products</b> .....	154
<b>Trap Primers Watts Regulator</b> .....	153
<b>Trap Standards PlumBest®</b> .....	159
<b>Traps</b>	
Armstrong® Inverted Bucket Steam .....	243, 245
Armstrong® Steam.....	243, 245
Barnes & Jones Thermostatic Steam .....	246
McGuire Products.....	159
<b>Trash Bags PlumBest®</b> .....	539
<b>Tridicators Wal-Rich Corporation</b> .....	282
<b>Truebro® Lav Guard®2 E-Z Pipe Covers</b> .....	161
<b>Tub &amp; Shower Faucets Central Brass</b> .....	71
<b>Tub &amp; Shower Modules Sterling Vikrell™</b> .....	122
<b>Tub &amp; Shower Stalls Aquatic</b> .....	123
<b>Tub &amp; Shower Systems</b>	
Grohe.....	69-70
Kohler.....	67-68
Symmons.....	64-65
<b>Tub &amp; Shower Units Aquatic</b> .....	124
<b>Tub Drain Removal Tools PlumBest®</b> .....	540
<b>Tub Drain Stoppers PlumBest®</b> .....	172
<b>Tub Drains Gerber</b> .....	169
<b>Tub Fillers Hansgrohe</b> .....	74
<b>Tub Protectors Oatey Bath</b> .....	171
<b>Tub Spouts</b>	
McGuire Products.....	172
PlumBest®.....	173
<b>Tube Benders Ridgid</b> .....	564-565
<b>Tube Brushes Mill-Rose Power Hex Shank</b> .....	546
<b>Tube Cutters Mill-Rose</b> .....	574
<b>Tube Support Brackets Warwick</b> .....	523
<b>Tubes</b>	
Cover.....	158
Wal-Rich Corporation Overflow.....	179
Wal-Rich Corporation Refill.....	180
<b>Tubing</b>	
Copper.....	370
Copper Medical Gas.....	371
Copper Refrigeration.....	370-371
Oatey Ice Maker Supply Kits.....	170
ProRadiant.....	484
PureFlow.....	484
Radiator Specialty Vinyl.....	505
<b>Tubing Clips Warwick</b> .....	523

<b>Tubing Cutter Parts Ridgid</b> .....	560
<b>Tubing Cutter Wheels Ridgid</b> .....	560
<b>Tubing Cutters</b>	
General Wire Spring Co Autocut™ .....	574
General Wire Spring Co SuperSlice™ Plastic .....	574
Lenox.....	574
Ridgid.....	558
<b>Tubing Tools Ridgid</b> .....	564
<b>Tubs</b>	
Aquatic.....	123
Kohler Select.....	120
<b>Tubular Brass</b>	
Keeney Mfg Co.....	159
McGuire Products.....	159-160
<b>Turbomax</b>	
Indirect Water Heaters .....	213
Neutralizing Tubes.....	235
<b>TurboTorch</b>	
Accessories.....	597
Acetylene Components.....	595
Air Acetylene.....	594
Alloys.....	597
Oxy-Acetylene Kits.....	595
Propane & MAPP®.....	595
Regulators & Gauges.....	596
Tanks/Cylinders.....	596
<b>Turrets Chicago Faucets</b> .....	63
<b>Tyco Sprinklers</b> .....	187
<b>Tyco Fire &amp; Building</b>	
Sprinkler Head Cabinets.....	186
Sprinkler Installation Tools.....	187
Sprinklers.....	187

## U

<b>Unichecks Zoeller Pump Valves</b> .....	198
<b>Unions</b>	
Brass Threaded.....	367
Copper.....	377
CPVC Schedule 80.....	415
Iron Black Malleable 150# Threaded .....	444
Iron Black Malleable 250# Threaded .....	444
Iron Black Malleable 300# Threaded .....	444
Iron Black Malleable Flanged.....	444
Iron Black Malleable Threaded.....	444
Iron Galvanized Malleable 150# Threaded....	447
PVC Schedule 80.....	411
Steel Forged 3000#.....	455
<b>Unit Heaters Modine Steam/Hot Water</b> .....	277
<b>United Brass Works Inc Boiler Trim Valves</b> .....	353
<b>Urinal Flushometers Kohler</b> .....	83
<b>Urinal Parts Sloan Flush Valves</b> .....	81
<b>Urinals</b>	
Kohler Vitreous China.....	112
Sloan WES Waterfree .....	113
<b>Utility Boxes Mill-Rose</b> .....	553
<b>Utility Knives</b>	

Prices & specifications are subject to change.

You can check stock availability, pricing and place orders online at [www.MetPipe.com](http://www.MetPipe.com).



## Product Index

Index

Lenox.....	587
PlumBest®.....	587
<b>Utility Pump</b>	
Liberty.....	192
Little Giant.....	192
<b>Utility Pumps</b> Zoeller.....	192
<b>Utility Straps</b> PlumBest® Heavy Duty.....	538

### V

<b>Vacuum Breakers</b>	
Hoffman Specialty.....	248
Watts Regulator.....	147
<b>Vacuum Relief Valves</b> Watts Regulator.....	143
<b>Vacuums</b> Ridgid Wet/Dry.....	575
<b>Valve Identification</b> Brady.....	363
<b>Valve Lockouts</b> Brady.....	364
<b>Valve Packing</b> John Crane High Temp.....	361
<b>Valve Tags</b>	
Brady.....	364
Stamped Brass.....	364
<b>Valves</b>	
A Y McDonald Bronze Gas Stop.....	358
A Y McDonald Bronze Radiator.....	358
American Cast Iron Ball.....	308
Apollo Bronze Ball.....	297
Apollo Instrumentation.....	355
Apollo Stainless Steel Ball.....	306
Apollo Steel Ball.....	304
Armstrong® Pressure & Temperature.....	290
AY McDonald Industrial Radiator & Steam.....	270
Backwater.....	424
Barnes & Jones Thermostatic Steam Trap.....	246
Bell & Gossett Circuit Setter®.....	270
Bell & Gossett Flo-Control™.....	270
Bell & Gossett Pressure Relief.....	270
Boiler Relief.....	143
BrassCraft® Ball Stops.....	155
BrassCraft® Shut-off Stops.....	156
BrassCraft® Stop.....	155
Bronze Check.....	318
Bronze Gate.....	311
Bronze Globe.....	315
Centerline Butterfly.....	349
Crane Cast Steel Check.....	331
Crane Cast Steel Gate.....	328
Crane Cast Steel Globe.....	330
Crane High Performance Check.....	348
Crane Instrumentation.....	356
Crane Iron Globe.....	324
Danfoss Radiator Valves & Accessories.....	295
Dragon Instrumentation.....	355
Eclipse Check.....	353
Edwards Forged Steel Check.....	343
Edwards Forged Steel Globe.....	338
Edwards Steel Blow-Off.....	354
Everlasting Iron Boiler Drain.....	353
Fire Safety.....	253
Flowseal Steel Butterfly.....	350

Grinnell® Grooved.....	474
Hammond Brass Hose End.....	359
Hammond Brass Stop & Waste.....	359
Heat-Timer Radiator.....	248
Hoffman Specialty Roberts Boiler Make-up.....	242
Hoffman Specialty Supply.....	296
Homestead Steel Plug.....	351
Honeywell Thermostatic Mixing.....	294
Honeywell Thermostatic Radiator Valves.....	291
Honeywell Thermostatic Valve Actuators.....	292
Jomar Add-A-Valve®.....	360
Leonard Valve Emergency.....	51, 134
Leonard Valve Mechanical Mixing.....	51, 134
Leonard Valve Mixing.....	134
Leonard Valve Point-of-Use.....	134
Lunkenheimer Bronze Blow-Off.....	354
Maid-O-Mist Air.....	249
McDonnell & Miller Blow Down.....	240
McGuire Products Stop.....	160
Nibco Butterfly.....	350
Nibco Copper Stop & Waste.....	358
Nibco Fire Prevention.....	352
Nibco Iron Check.....	325
Nibco Iron Gate.....	323
Plastic Backwater.....	409
PlumBest® Radiator Coin Key Air.....	251
Powell Cast Steel Check.....	332
Powell Stainless Steel Check.....	346
Powell Stainless Steel Gate.....	344
Precision Plumbing Products Primer.....	154
Press Ball.....	303
Pressure Relief.....	143
ProRadiant.....	491
Purge & Balancing.....	152
Raven Brass Boiler.....	359
Rockford Check.....	353
Spears Ball.....	309
Spears CPVC Ball.....	310
Spears PVC Ball.....	309-310
Spears PVC Check.....	309
Spears PVC True Union Ball Check.....	310
SpiroTherm Air Eliminators.....	250
SpiroTherm Air Release.....	249
SpiroTherm Air Releases.....	250
Strataflo Brass Foot.....	360
Symmons Mixing.....	183
Taco Inc Flo-Chek.....	269
Taco Inc Zone.....	269
Tasco Instrumentation.....	356
Thermostatic Mixing.....	134
True Union Ball.....	310
United Bronze Boiler.....	353
Vent-Rite Company Air.....	250
Vogt Forged Steel Check.....	339
Vogt Forged Steel Gate.....	334
Vogt Forged Steel Globe.....	336
Vogt Instrumentation.....	357
Watts Flippen Float.....	153
Watts Regulator.....	136, 151-152
Watts Regulator Backflow Preventers.....	144
Watts Regulator Boiler Fill.....	152
Watts Regulator Commercial Iron Gate.....	150
Watts Regulator Hydronic.....	152
Watts Regulator Iron Commercial Gate.....	149



## Product Index

Watts Regulator Poppet.....	143
Watts Regulator Pressure Relief.....	143
Watts Regulator Safety Relief.....	139
Watts Regulator Safety Valves.....	143
Watts Regulator T&P Relief.....	142
Watts Regulator Washing Machine.....	182
Watts Regulator Water Heater Safety.....	143
Zoeller Pump.....	198
<b>Van Hangers.....</b>	<b>522</b>
<b>Van Stone Flanges.....</b>	<b>415</b>
<b>Vent Caps SpeedFill.....</b>	<b>253</b>
<b>Vent-Rite</b>	
Convector Valves.....	248
Riser Air Valves.....	248
<b>Vent-Rite Company Air Valves.....</b>	<b>250</b>
<b>Venting Systems ProTech.....</b>	<b>256</b>
<b>Vents</b>	
Armstrong® Air/Gas.....	248
Hoffman Specialty Main Steam.....	249
Hoffman Specialty Main Water.....	249
Hoffman Specialty Special Steam.....	249
Lambro Industries Dryer Kits.....	255
Oil Filters.....	254
Taco Inc Automatic Air.....	250
Wal-Rich Corporation Automatic Plumbing....	185
<b>Vertical Center Faucets Chicago Faucets.....</b>	<b>56</b>
<b>Viega Manablocs.....</b>	<b>494</b>
<b>Vikrell™ Shower Modules Sterling.....</b>	<b>121</b>
<b>Vikrell™ Tub &amp; Shower Modules Sterling.....</b>	<b>122</b>
<b>Vinyl Tubing Radiator Specialty.....</b>	<b>505</b>
<b>Vises Ridgid Bench.....</b>	<b>531</b>
<b>Vogt</b>	
Forged Steel Check Valves.....	339
Forged Steel Gate Valves.....	334
Forged Steel Globe Valves.....	336
Instrumentation Valves.....	357
<b>Vogt Valve</b>	
Forged Globe Valves.....	343
Stainless Steel Globe Valves.....	345

### W

<b>Wal-Rich Escutcheons.....</b>	<b>162</b>
<b>Wal-Rich Corporation</b>	
Automatic Plumbing Vents.....	185
Basin Nut Wrenches.....	542
Bathcock Couplings.....	180
Bead Chain Couplings.....	172
Beaded Chain.....	172
Brass Ballcock Rods.....	180
Brass Closet Screws.....	180
Brass Lift Wires.....	180
Cast Iron Solder Pot.....	544
Caulking.....	543
Closet Spud Friction Rings.....	180
Closet Spuds.....	180
Coupling Nuts.....	162
CP Crown Tank Levers.....	175

Domestic Pipe Taps.....	543
Drop Lights.....	531
Electrical Supplies.....	531
Escutcheons.....	162
Extension Cords.....	531
Faucet Accessories.....	170
Garden Hose Accessories.....	189
Garden Hose Adapter.....	170
Gauge Glass Cutters.....	574
Gauges.....	282
Grip-Tite Handles.....	543
Hose Accessories.....	189
Imported Combination Aerators.....	170
Instruments.....	282
Lampwick Balls.....	543
Magna Tools.....	543
MI Compression Couplings.....	481
Non-Asbestos Graphite Packing Spools.....	543
Non-Asbestos Joint Runner.....	543
Overflow Tubes.....	179
Pick-up Tools.....	542
Pipe Connections & Repair.....	481
Pipe Taps.....	543
Pistol Grip Hose Nozzle.....	189
Plastic Float Ball.....	179
Plugs.....	185
Radiator Handles.....	543
Radiator Repair Tools.....	541
Radiator Spud Wrenches.....	542
Refill Tubes.....	180
Rough Service Bulbs.....	531
Screw Extractors.....	543
Seat Wrenches.....	542
Solder Ladles.....	543
Specialty Tools.....	534, 542
Specialty Wrenches.....	542
Steam Siphon Pigtales.....	282
Steam Specialties.....	543
Sump Pump Hose.....	199
T-Handle Hex Key Set.....	534
Toilet Paper Roller.....	180
Toilet Supplies.....	179
Tub Spouts & Accessories.....	172
<b>Wall Guards Duraguard™ EL Mustee.....</b>	<b>97</b>
<b>Warwick</b>	
Natick Hangers.....	523
PVC Hangers.....	523
Tube Support Brackets.....	523
Tubing Clips.....	523
<b>Washers.....</b>	<b>517</b>
<b>Washers</b>	
Fender.....	522
Fish Plate.....	522
Flush Valve Shank.....	179
Gunk® Faucet.....	163
Gunk® Slip-Joint.....	163
PlumBest®.....	161
Radiator Specialty Beveled Cone.....	164
Radiator Specialty Spud.....	179
<b>Washing Machine Connectors Fluidmaster®.....</b>	<b>176</b>
<b>Washing Machine Pans Oatey.....</b>	<b>182</b>
<b>Washing Machine Valves Watts Regulator.....</b>	<b>182</b>
<b>Waste Cleaners Hercules®.....</b>	<b>604-605</b>

Prices & specifications are subject to change.

We offer a variety of GREEN products such as flush valves, faucets, showerheads & more!



## Product Index

Index

<b>Waste Pipe</b> Orion Fittings.....	398	<b>Water Vents</b> Hoffman Specialty Main.....	249
<b>Watchman®</b> Hoffman Specialty Condensate Pumps.....	242	<b>Watts</b>	
<b>Water Bubblers</b> .....	13	Air Purgers.....	219
<b>Water Chillers</b> .....	12	Tankless Water Heater Valves.....	215
<b>Water Coolers</b>		<b>Watts Drainage</b>	
Bottle Filling.....	12	Copper Floats.....	154
Chillers.....	12	Flippen Float Valves.....	153
Floor Standing.....	11	Interceptors.....	131
Wall Mounted.....	11-12	<b>Watts FluidAir</b>	
<b>Water Dispensers</b> InSinkErator® Hot Water.....	33	Compressed Air Treatment.....	296
<b>Water Feeders</b>		Miniature FRL Series Regulators.....	296
McDonnell & Miller.....	239	<b>Watts Regulator</b>	
Watts Regulator.....	152	Air Gaps.....	149
<b>Water Filters</b>		Backflow Preventers.....	144
Aquasure.....	14-17	Commercial Iron Gate Valves.....	150
Gasket Kits.....	17	Commercial Y-Strainers.....	150
Housings.....	14-17	Flow Control Valves.....	131
O-Rings.....	17	Hose Assembly Kit.....	149
Parts & Accessories.....	17	Hydronic Test Plugs.....	153
Replacement Cartridges.....	14-17	Hydronic Valves.....	152
Test Kits.....	17	Iron Commercial Gate Valves.....	149
Wrenches.....	17	Pressure Relief Valves.....	143
<b>Water Fountains</b>		Safety Relief Valves.....	139, 142-143
Bubblers.....	13	Steam Pressure Regulators.....	138, 290
Chillers.....	12	Tempering/Mixing Valves.....	151
Drinking Faucets.....	13	Test Cocks.....	149
Wall Mounted.....	11-13	Trap Primers.....	153
<b>Water Hammers</b> Watts Regulator.....	153	Vacuum Breakers.....	147
<b>Water Heater Accessories</b> .....	218	Vacuum Relief Valves.....	143
<b>Water Heater Pans</b> .....	220	Washing Machine Valves.....	182
<b>Water Heater Valves</b>		Water Hammers.....	153
Watts Regulator Relief.....	142	Water Heater Safety Valves.....	143
Watts Regulator Safety.....	143	Water Pressure Regulators.....	136
Watts Regulator Tankless.....	152	<b>Wax Gaskets</b>	
<b>Water Heaters</b>		Harvey.....	176
Aluminum Pans.....	220	Hercules®.....	178
Ariston.....	200	<b>Weil-McLain</b>	
Commercial.....	204, 216	Commercial Boilers.....	231
Commercial Electric.....	206-207	Gas Boilers.....	221-222
Commercial Gas.....	204-205	Indirect Water Heaters.....	212
Eemax.....	200	Oil Boilers.....	223
Floodmaster.....	220	<b>Weld Fittings</b> Steel Carbon.....	455
FloodStopper.....	219	<b>Weld-O-Lets</b> Forged Steel 3000#.....	448
Indirect.....	211-213	<b>Welding</b> TurboTorch.....	594-597
Leak Detection.....	219-220	<b>Well Assemblies</b> Honeywell.....	286
Lochinvar.....	204-205	<b>Wet/Dry Vacuums</b> Ridgid.....	575
Navien.....	214-215	<b>Wheeler Rex</b>	
Noritz.....	216	Glass Cutters.....	574
Plastic Pans.....	220	Test Pumps.....	548
Point-of-use.....	200	<b>Wheels</b>	
Residential Electric.....	202-203	Lenox Cutter.....	574
Residential Gas.....	201-202	Milwaukee® Cut-Off Machine.....	582
Ruud.....	201-207	Milwaukee® Grinder.....	582
SuperStor HTP.....	211	Ridgid Pipe Cutter.....	562
Tankless.....	200, 214	Ridgid Tubing Cutter.....	560
Tankless Valves.....	215	<b>Whitlam</b> Descalers.....	601
Turbomax.....	213	<b>Wicking</b> Wal-Rich Corporation.....	543
Weil-McLain.....	212	<b>Wire Brushes</b> PlumBest®.....	547
<b>Water Pressure Regulators</b> Watts Regulator.....	136	<b>Wire Stripping</b> Channellock®.....	537
<b>Water Supply Connectors</b> Fluidmaster® Flexible.....	170, 175-176		

Prices & specifications are subject to change.



## Product Index

<b>Wolverine Solders</b> .....	598
<b>Wood Toilet Seats</b> Church@.....	117
<b>Work Board Faucets</b> T&S Brass.....	26
<b>Work Gloves</b>	
Irwin® Industrial Tools.....	550
Leather.....	550
PlumBest®.....	550
<b>Worm Gear Clamps</b> Ideal General Purpose.....	525
<b>Wrenches</b>	
Barnes & Jones Cover.....	247
Channellock®.....	534
Irwin® Industrial Tools.....	535
PlumBest®.....	534
Raven Symmons Valve Wrench.....	542
Rectorseal Pipe.....	541
Ridgid.....	554
Ridgid Compound Leverage.....	555
Seekonk Torque.....	541
Wal-Rich Corporation Basin Nut.....	542
Wal-Rich Corporation Seat.....	542
Wal-Rich Corporation, Radiator Spud.....	542

### Y

<b>Y-Strainers</b>	
Apollo Valves.....	151
Watts Regulator Commercial.....	150

### Z

<b>Z-Tacks</b> Johns-Manville.....	515
<b>Zeston PVC Fitting Covers</b> Johns-Manville.....	514
<b>Zoeller</b>	
Dewatering Pumps.....	196
Floor Sucker Pump.....	192
Full-Flow Unichucks.....	198
High Temperature Pumps.....	196
Laundry Tray Pumps.....	191
Pump Parts.....	199
Qwik Jon® Systems.....	116
Sewage Basins.....	199
Sewage Pumps.....	197
Sump Pumps.....	193-195
Utility Pumps.....	192
<b>Zone Valve Controls</b> Taco.....	237
<b>Zone Valves</b>	
Honeywell.....	287
Taco Inc.....	269
Watts Regulator Hydronic.....	152
<b>Zurn®</b>	
Closet Carrier Trim Kit.....	180
Closet Gaskets.....	180
Flanges.....	162
Hydrant Key.....	186, 541















#### ORDER ACCEPTANCE

All catalogs, price lists, literature or other material describing our products are not to be construed as offers to sell. Orders are subject to acceptance by us at our office in Cambridge, MA. Your order, when shipped by us, shall be the complete contract between us, subject to and incorporating therein the terms and conditions herein contained, and any inconsistent provisions contained in your order shall not apply. **Prices and discounts contained in any of our catalogs, price lists or other literature are subject to change without notice.**

#### CANCELLATION

Orders are not subject to cancellation without our written consent. If an order is cancelled, the Buyer shall pay all costs incurred with fulfilling the order. Any charges incurred because of cancellation or change of special material made on order must be paid for by the Buyer. Any items not cataloged by us and made on special order remain the property of the Buyer and must be paid for.

#### GUARANTEE / WARRANTY

Please refer to manufacturers literature for warranty information. Metropolitan Pipe shall not be responsible for any labor charges or any loss, injury or damages whatsoever, including incidental or consequential damages due to defective products.

#### DELAYS

Metropolitan Pipe will not assume any liability for delays or defaults occasioned by strikes, fires or other circumstances beyond our control.

#### RETURNED GOODS

Material may be returned subject to the following conditions:

1. Must first be referred to Metropolitan Pipe for inspection, approval, and prompt handling;
2. Credit for parts given only if purchased as parts;
3. Buyer must identify original shipment of material by invoice number and invoice date;
4. Prior written permission;
5. Up to a 25% restocking charge;
6. Any charges necessary to put the material into saleable condition;
7. Outgoing freight will be deducted from the credit;
8. Material must be returned freight prepaid;
9. Discontinued or obsolete material ONLY returnable by special negotiation.

#### ILLUSTRATIONS AND DESCRIPTIONS

All illustrations, submittals and accompanying descriptions describe standard features of each product and do not necessarily show or describe the variations available. All designs are subject to change without notice, and, unless specially stated on the order, material will be furnished of design in effect at the time the order is billed. All weights are approximate.

#### RISKS

Our responsibility ceases after the product has been delivered to the carrier in good order. It is the responsibility of the consignee to inspect each shipment carefully and file a claim with the carrier for any damage or shortage. Content shortages must be reported within 15 days after receipt of material. Any claim received after this time will be disallowed.

# Credit Application

Please fax to: 617-876-8449.

Date: \_\_\_\_ / \_\_\_\_ / \_\_\_\_

Full Company Name: \_\_\_\_\_ Sole Proprietor: \_\_\_\_\_

Address: \_\_\_\_\_ Partnership: \_\_\_\_\_

City: \_\_\_\_\_ State: \_\_\_\_\_ Zip: \_\_\_\_\_

Telephone: (\_\_\_\_) \_\_\_\_ - \_\_\_\_ Fax: (\_\_\_\_) \_\_\_\_ - \_\_\_\_ Credit Limit Desired: \$ \_\_\_\_\_

Company Officers: \_\_\_\_\_ Title: \_\_\_\_\_

Partners: \_\_\_\_\_ Title: \_\_\_\_\_

Banking: \_\_\_\_\_ Checking/Savings/Loans: \_\_\_\_\_  
(Name & Address)

## Trade References

1.) Name: \_\_\_\_\_ Telephone: (\_\_\_\_) \_\_\_\_ - \_\_\_\_

Address: \_\_\_\_\_ Fax: (\_\_\_\_) \_\_\_\_ - \_\_\_\_

2.) Name: \_\_\_\_\_ Telephone: (\_\_\_\_) \_\_\_\_ - \_\_\_\_

Address: \_\_\_\_\_ Fax: (\_\_\_\_) \_\_\_\_ - \_\_\_\_

3.) Name: \_\_\_\_\_ Telephone: (\_\_\_\_) \_\_\_\_ - \_\_\_\_

Address: \_\_\_\_\_ Fax: (\_\_\_\_) \_\_\_\_ - \_\_\_\_

Number of Invoice Copies Required: \_\_\_\_\_

Purchase Order Required? \_\_\_\_\_

Monthly Statement Required? \_\_\_\_\_

Charge Sales Tax? \_\_\_\_\_

*If no, please attach resale certificate.*

Invoice/Statement Delivery: [  ] E-mail (Address: \_\_\_\_\_) [  ] Fax [  ] Postal

The undersigned certifies that the above information is correct, that it is submitted for the purpose of obtaining credit, and agrees to the terms and conditions of sale by Metropolitan Pipe & Supply Co.

\_\_\_\_\_ Date: \_\_\_\_ / \_\_\_\_ / \_\_\_\_

Authorized Signature

\_\_\_\_\_ Business Name

**1-800-MetPipe**  
**www.MetPipe.com**

